



# PRODUCT SPECIFICATION

**Model No : CST-432B7/431B7**

## Descriptions:

- 0.4 Inch Triad Digits Display
- CST-432: Common Anode
- CST-431: Common Cathode
- Emitting Color: Super Bright Blue



CUSTOMER APPROVED SIGNATURES	APPROVED BY	CHECKED BY	PREPARED BY

**CHINA SEMICONDUCTOR CORPORATION**  
Address:2FL. NO.909,Chung-Cheng Road,  
Chung-Ho City Taipei Hsien,Taiwan.

Tel:886-2-2223-9696  
Fax:886-2-2223-9377

**OPTO PLUS TECHNOLOGIES CO.,LTD**  
Address:696 Shun jiang Rd.,Ji Shan St.Shaoxing,  
ZheJiang,China

Tel:86-0575-88623888  
Fax:86-0575-88623112



<b>Spec. No.</b>	PS-ND-08072511
<b>Rev.</b>	A

**Model No : CST-432/431B7**

**■ Features -**

1. 0.4 inch (10.2mm) digit height.
2. Case mold type.
3. RoHS compliant.
4. Low power consumption.
5. ESD > 1KV(HBM)
6. Easy mounting on P.C. board or socket.

**■ Device Selection Guide -**

Part No.	Chip		Description
	Material	Emitted Color	
<b>CST-432B7</b>	<b>InGaN</b>	<b>Super Bright Blue</b>	<b>Common Anode</b>
<b>CST-431B7</b>	<b>InGaN</b>	<b>Super Bright Blue</b>	<b>Common Cathode</b>

**■ Package Dimensions -**

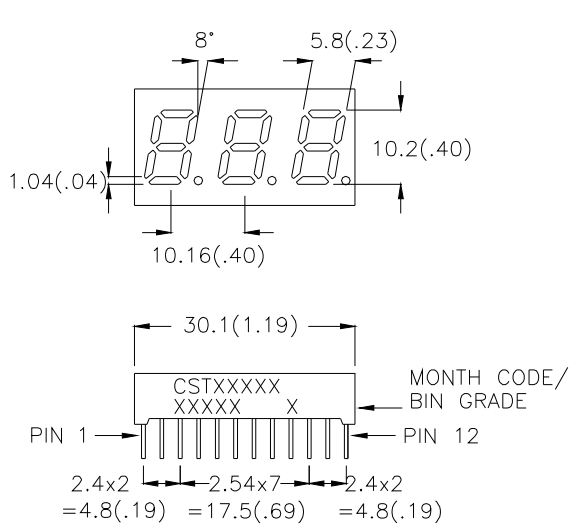

**NOTE:**

1. All pins are  $\phi 0.5(.02)$ .
2. Dimension in millimeter (inch), and tolerance is  $\pm 0.25 (.01)$  unless otherwise noted.



Model No : CST-432/431B7

Internal Circuit Diagrams -

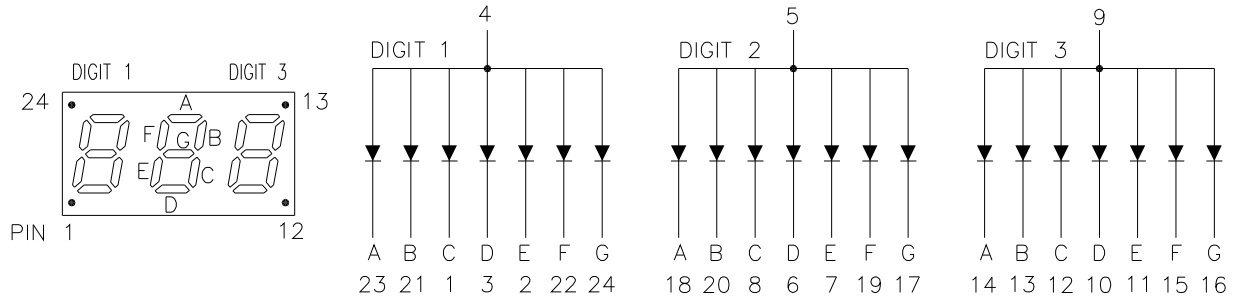

CST-432 Common Anode  
(CST-431 Common Cathode)

Absolute Maximum Rating -

(Ta=25°C)

Parameter	Symbol	Rating	Unit
Power Dissipation Per Dice	PAD	120	mW
Continuous Forward Current Per Dice	IAF	30	mA
Peak Current Per Dice(duty cycle 1/10,1KHz)	IPF	100	mA
Derating Linear From 25°C Per Dice	-	0.4	mA/°C
Reverse Voltage Per Dice	VR	5	V
Operating Temp.	Topr	-35 ~ +85	°C
Storage Temp.	Tstg	-35 ~ +85	°C
Solder temperature 1/16 inch below seating plane for 3 seconds at 260°C			



Model No : CST-432/431B7

■ Electro-optical Characteristics -

(Ta=25°C)

Parameter	Symbol	Min.	Typ.	Max.	Unit	Condition
Forward Voltage Per Segment	V <sub>F</sub>	-	3.5	4	V	I <sub>F</sub> =20mA
Luminous Intensity Per Segment	I <sub>v</sub>	-	15	-	mcd	I <sub>F</sub> =10mA
Peak Emission Wavelength	λ <sub>p</sub>	-	468	-	nm	I <sub>F</sub> =20mA
Dominant Wavelength	λ <sub>d</sub>	-	470	-	nm	I <sub>F</sub> =20mA
Spectrum Radiation Bandwidth	Δλ	-	30	-	nm	I <sub>F</sub> =20mA
Reverse Current	I <sub>R</sub>	-	-	100	μA	V <sub>R</sub> =5V
Luminous Intensity Matching Ratio	IV-m	-	-	2:1	-	I <sub>F</sub> =10mA



Model No : CST-432/431B7

### ■ Typical Electrical / Optical Characteristics Curves -

(Ta = 25°C Unless Otherwise Noted)

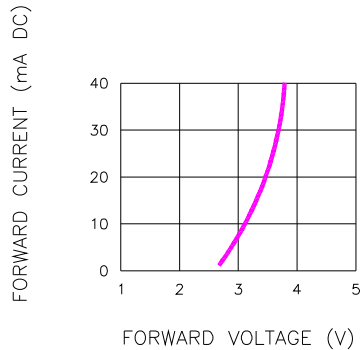

Fig.1 FORWARD CURRENT VS. FORWARD VOLTAGE

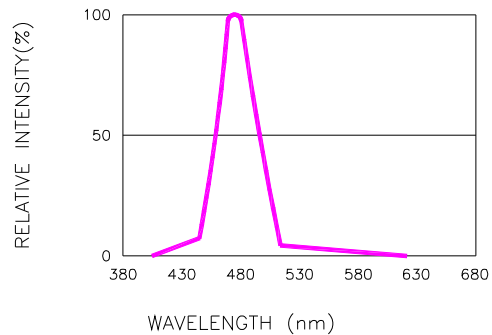

Fig.2 RELATIVE INTENSITY VS. WAVELENGTH

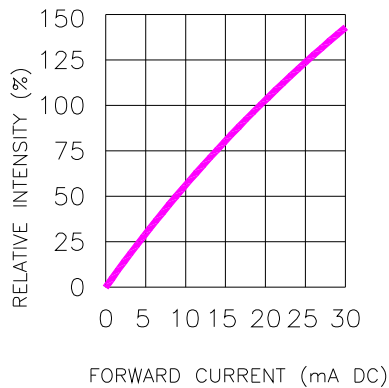

Fig.3 RELATIVE INTENSITY VS. FORWARD CURRENT

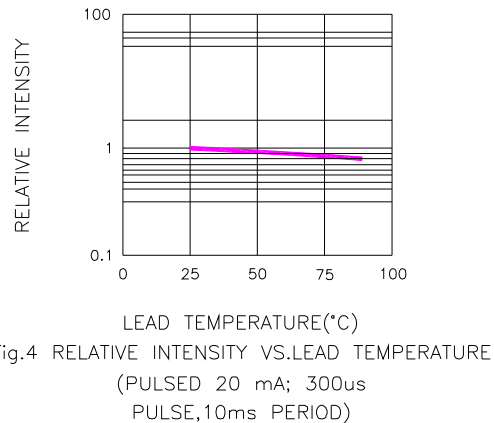

Fig.4 RELATIVE INTENSITY VS. LEAD TEMPERATURE  
(PULSED 20 mA; 300us  
PULSE, 10ms PERIOD)

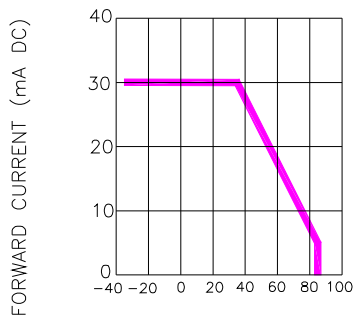

Fig.5 FORWARD CURRENT VS. AMBIENT TEMPERATURE

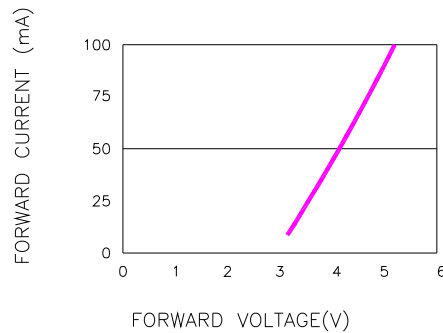

Fig.6 PEAK FORWARD VOLTAGE VS. FORWARD (100us TEST PULSE, 1% DUTY CYCLE)



Spec. No.	PS-ND-08072511
Rev.	A

Model No : CST-432/431B7

■ Package Dimensions

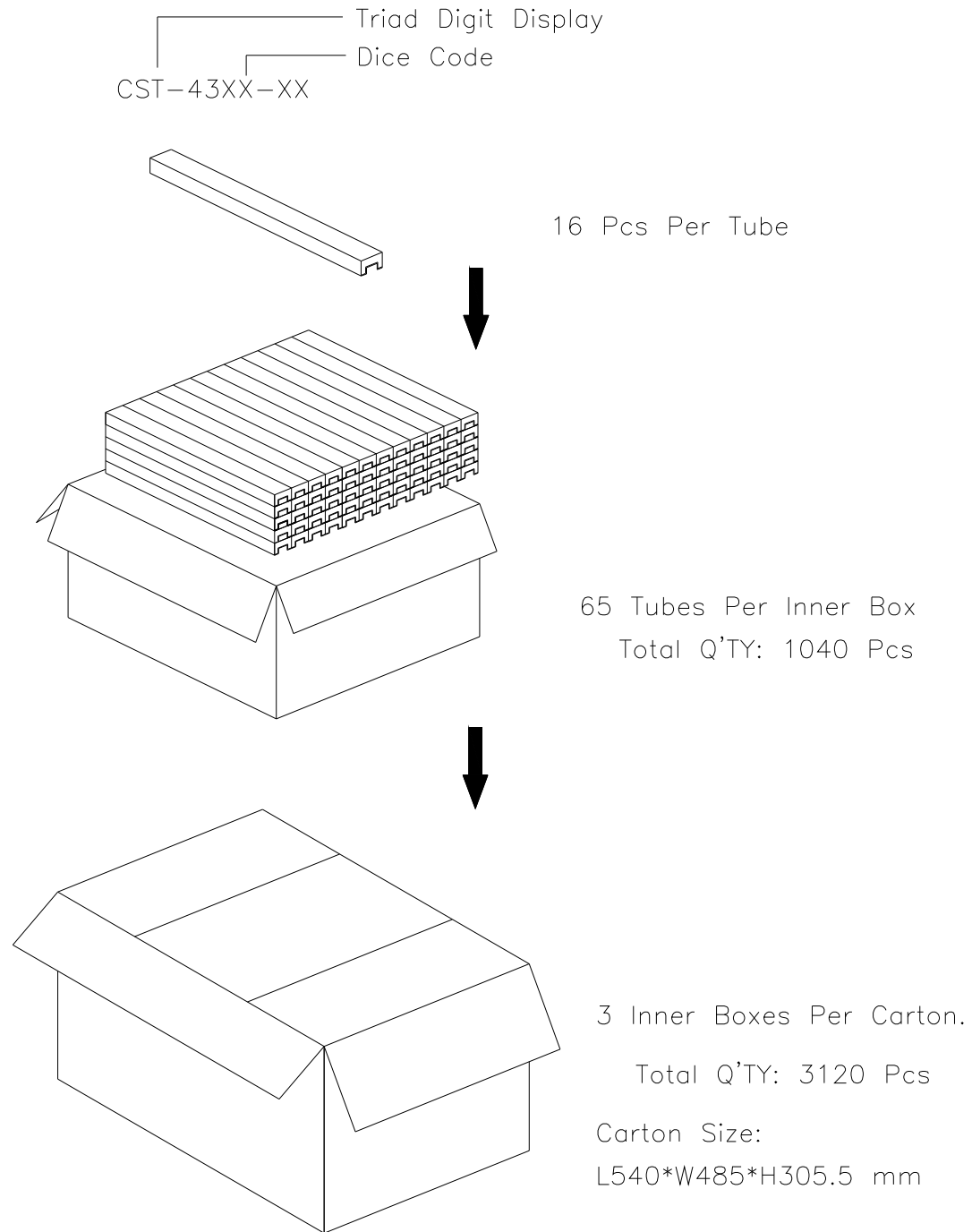

Note: The specifications are subject to change without notice. Please contact us for updated information.