

CCM-PFC

ICE2PCS04

ICE2PCS04G

Standalone Power Factor
Correction (PFC) Controller in
Continuous Conduction Mode
(CCM) with Input Brown-Out
Protection

Power Management & Supply



Never stop thinking.

Previous Version:

Page	Subjects(major changes since last version)

For questions on technology, delivery and prices please contact the Infineon Technologies Offices in Germany or the Infineon Technologies Companies and Representatives worldwide: see our webpage at <http://www.infineon.com>

CoolMOS™, CoolSET™ are trademarks of Infineon Technologies AG.

Edition 2007-10-10

**Published by
Infineon Technologies AG
81726 München, Germany**

**© 2007 Infineon Technologies AG
All Rights Reserved.**

Legal Disclaimer

The information given in this document shall in no event be regarded as a guarantee of conditions or characteristics. With respect to any examples or hints given herein, any typical values stated herein and/or any information regarding the application of the device, Infineon Technologies hereby disclaims any and all warranties and liabilities of any kind, including without limitation, warranties of non-infringement of intellectual property rights of any third party.

Information

For further information on technology, delivery terms and conditions and prices please contact your nearest Infineon Technologies Office (www.infineon.com).

Warnings

Due to technical requirements components may contain dangerous substances. For information on the types in question please contact your nearest Infineon Technologies Office.

Infineon Technologies Components may be used in life-support devices or systems only with the express written approval of Infineon Technologies, if a failure of such components can reasonably be expected to cause the failure of that life-support device or system, or to affect the safety or effectiveness of that device or system. Life support devices or systems are intended to be implanted in the human body, or to support and/or maintain and sustain and/or protect human life. If they fail, it is reasonable to assume that the health of the user or other persons may be endangered.

Standalone Power Factor Correction (PFC) Controller in Continuous Conduction Mode (CCM) with Input Brown-Out Protection

Product Highlights

- Leadfree DIP and DSO Package
- Wide Input Range
- Direct sensing, Input Brown-Out Detection
- Optimized for applications which require fast Startup
- Output Power Controllable by External Sense Resistor
- Fast Output Dynamic Response during Load Jumps
- Trimmed, internal fixed Switching Frequency (133kHz)

Features

- Ease of Use with Few External Components
- Supports Wide Input Range
- Average Current Control
- External Current and Voltage Loop Compensation for Greater User Flexibility
- Trimmed internal fixed Switching Frequency (133kHz±5% at 25°C)
- Direct sensing, Input Brown-Out Detection with Hysteresis
- Short Startup(SoftStart) duration
- Max Duty Cycle of 95% (typ)
- Trimmed Internal Reference Voltage (3V±2%)
- VCC Under-Voltage Lockout
- Cycle by Cycle Peak Current Limiting
- Output Over-Voltage Protection
- Open Loop Detection
- Soft Overcurrent Protection
- Enhanced Dynamic Response
- Fulfills Class D Requirements of IEC 1000-3-2

Description

The ICE2PCS04/G is a 8-pin wide input range controller IC for active power factor correction converters. It is designed for converters in boost topology, and requires few external components. Its power supply is recommended to be provided by an external auxiliary supply which will switch on and off the IC.

The IC operates in the CCM with average current control, and in DCM only under light load condition. The switching frequency is trimmed and fixed internally at 133kHz. Both current and voltage loop compensations are done externally to allow full user control.

There are various protection features incorporated to ensure safe system operation conditions. The internal reference is trimmed (3V±2%) to ensure precise protection and output control level.

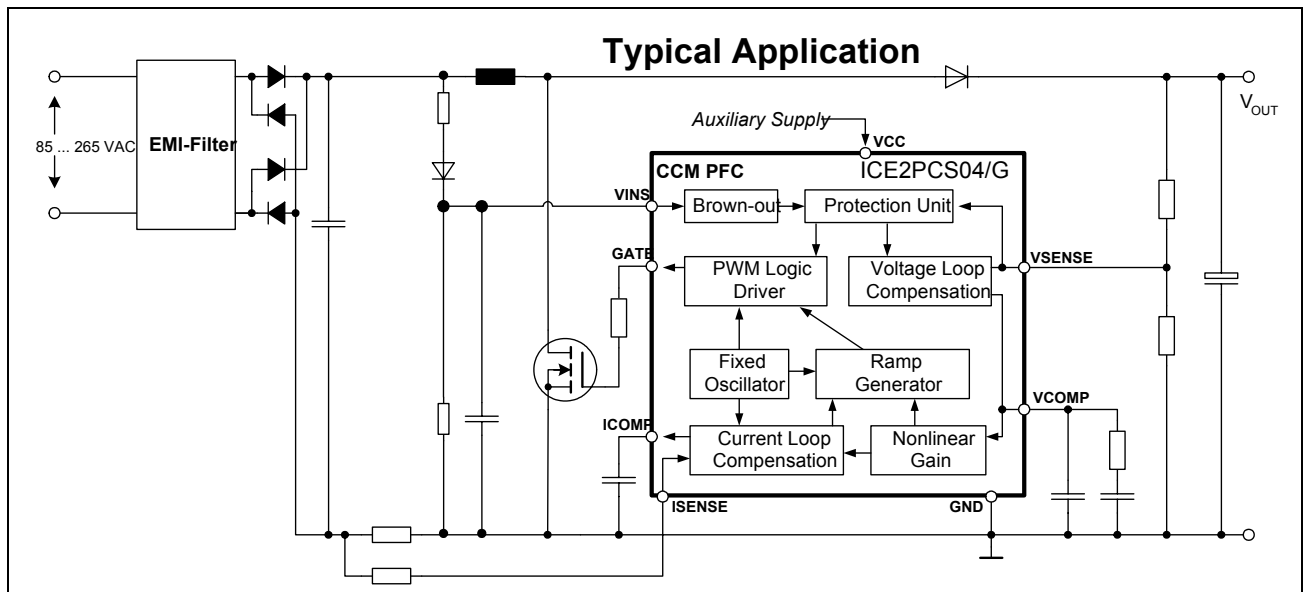
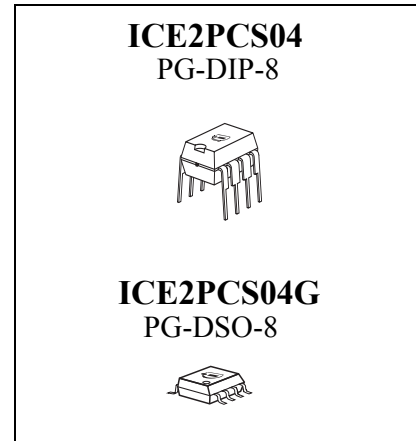

Type	Package
ICE2PCS04	PG-DIP-8
ICE2PCS04G	PG-DSO-8

1	Pin Configuration and Functionality	5
1.1	Pin Configuration	5
1.2	Pin Functionality	5
2	Representative Block diagram	6
3	Functional Description	7
3.1	General	7
3.2	Power Supply	7
3.3	Start-up	7
3.4	System Protection	8
3.4.1	Input Brown-Out Protection (IBOP)	8
3.4.2	Soft Over Current Control (SOC)	9
3.4.3	Peak Current Limit (PCL)	9
3.4.4	Open Loop Protection (OLP)	9
3.4.5	Over-Voltage Protection (OVP)	9
3.5	Fixed Switching Frequency	9
3.6	Average Current Control	10
3.6.1	Complete Current Loop	10
3.6.2	Current Loop Compensation	10
3.6.3	Pulse Width Modulation (PWM)	10
3.6.4	Nonlinear Gain Block	10
3.7	PWM Logic	11
3.8	Voltage Loop	11
3.8.1	Voltage Loop Compensation	11
3.8.2	Enhanced Dynamic Response	11
3.9	Output Gate Driver	11
4	Electrical Characteristics	13
4.1	Absolute Maximum Ratings	13
4.2	Operating Range	13
4.3	Characteristics	14
4.3.1	Supply Section	14
4.3.2	PWM Section	14
4.3.3	System Protection Section	15
4.3.4	Current Loop Section	15
4.3.5	Voltage Loop Section	16
4.3.6	Driver Section	17
5	Outline Dimension	18

1 Pin Configuration and Functionality

1.1 Pin Configuration

Pin	Symbol	Function
1	GND	IC Ground
2	ICOMP	Current Loop Compensation
3	ISENSE	Current Sense Input
4	VINS	Brown-out Sense Input
5	VCOMP	Voltage Loop Compensation
6	VSENSE	V _{OUT} Sense (Feedback) Input
7	VCC	IC Supply Voltage
8	GATE	Gate Drive Output

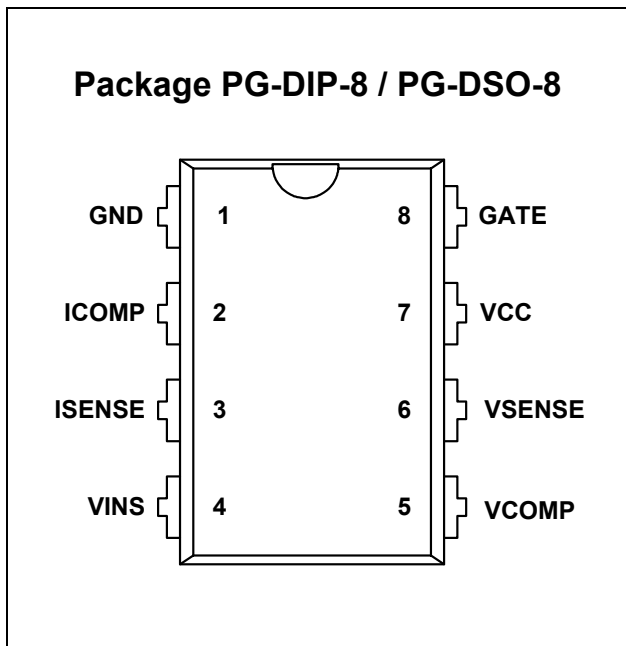

Figure 1 Pin Configuration (top view)

1.2 Pin Functionality

GND (Ground)

The ground potential of the IC.

ICOMP (Current Loop Compensation)

Low pass filter and compensation of the current control loop. The capacitor which is connected at this pin integrates the output current of OTA2 and averages the current sense signal.

ISENSE (Current Sense Input)

The ISENSE Pin senses the voltage drop at the external sense resistor (R1). This is the input signal for the average current regulation in the current loop. It is also fed to the peak current limitation block.

During power up time, high inrush currents cause high negative voltage drop at R1, driving currents out of pin 3 which could be beyond the absolute maximum ratings. Therefore a series resistor (R2) of around 220Ω is recommended in order to limit this current into the IC.

VINS (Brown-out Sense Input)

This VINS pin senses a filtered input voltage divider and detects for the input voltage Brown-out condition. A Brown-out condition of VINS < 0.71V, shuts down the IC. The IC turns on at VINS > 1.5V.

VSENSE (Voltage Sense/Feedback)

The output bus voltage is sensed at this pin via a resistive divider. The reference voltage for this pin is 3V.

VCOMP (Voltage Loop Compensation)

This pin provides the compensation of the output voltage loop with a compensation network to ground (see Figure 2).

VCC (Power Supply)

The VCC pin is the positive supply of the IC and should be connected to an external auxiliary supply. The operating range is between 11V and 26V. The turn-on threshold is at 11.8V and under voltage occurs at 11V. There is no internal clamp for a limitation of the power supply.

GATE

The GATE pin is the output of the internal driver stage, which has a capability of 1.5A instantaneous source and 2.0A instantaneous sink current.

Its gate drive voltage is internally clamped at 15.0V (typically).

2 Representative Block diagram

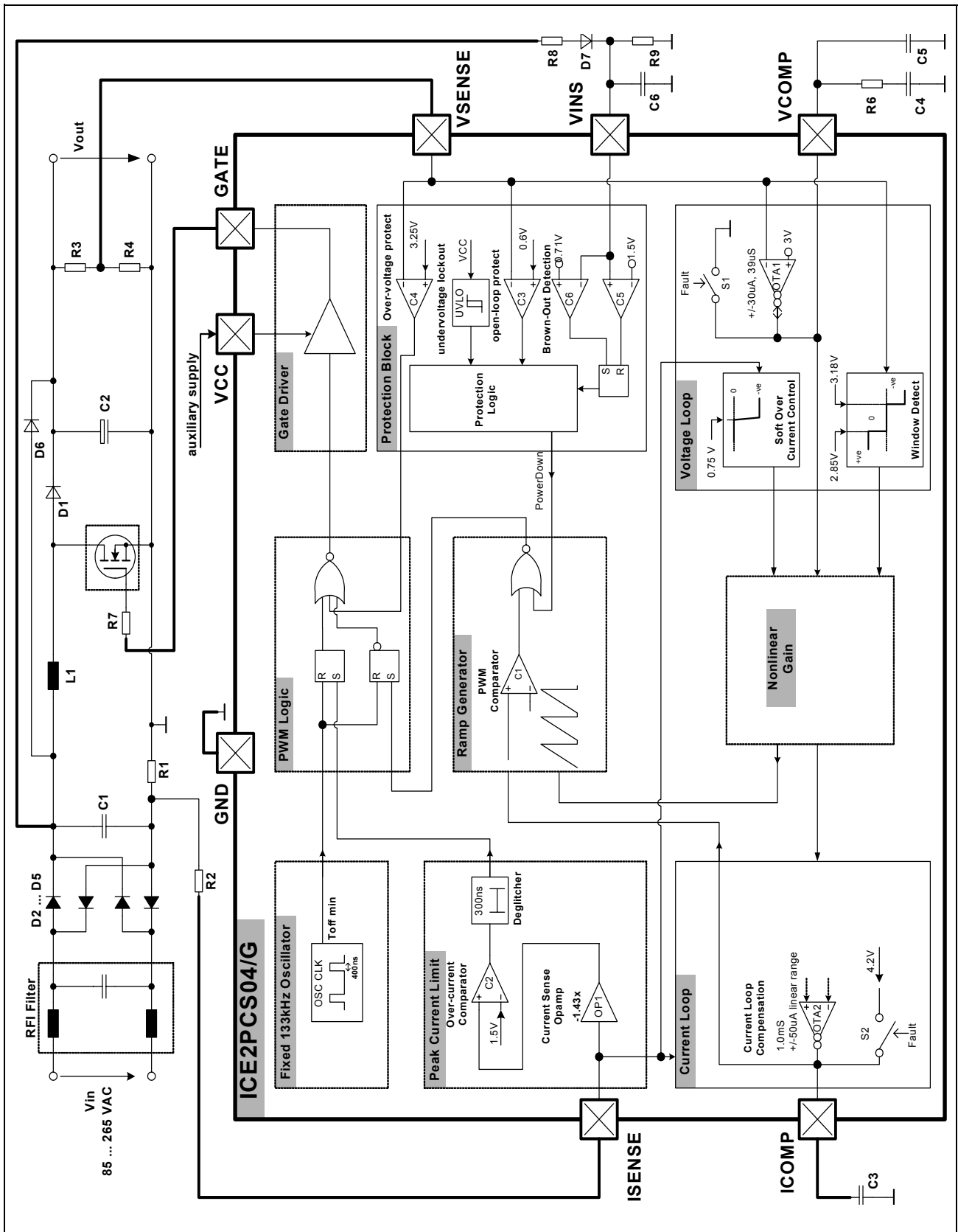

Figure 2 Representative Block diagram

3 Functional Description

3.1 General

The ICE2PCS04/G is a 8 pin control IC for power factor correction converters. It comes in both DIP and DSO packages and is suitable for wide range line input applications from 85 to 265 VAC. The IC supports converters in boost topology and it operates in continuous conduction mode (CCM) with average current control.

It is a design derivative from the ICE2PCS01/G with the differences in the supporting functions, namely the input brown-out detection and internal fixed switching frequency 133kHz.

The IC operates with a cascaded control; the inner current loop and the outer voltage loop. The inner current loop of the IC controls the sinusoidal profile for the average input current. It uses the dependency of the PWM duty cycle on the line input voltage to determine the corresponding input current. This means the average input current follows the input voltage as long as the device operates in CCM. Under light load condition, depending on the choke inductance, the system may enter into discontinuous conduction mode (DCM) resulting in a higher harmonics but still meeting the Class D requirement of IEC 1000-3-2.

The outer voltage loop controls the output bus voltage. Depending on the load condition, OTA1 establishes an appropriate voltage at VCOMP pin which controls the amplitude of the average input current.

The IC is equipped with various protection features to ensure safe operating condition for both the system and device.

3.2 Power Supply

An internal under voltage lockout (UVLO) block monitors the VCC power supply. As soon as it exceeds 11.8V and both voltages at pin 6 (VSENSE) >0.6V and pin 4 (VINS) >1.5V, the IC begins operating its gate drive and performs its Startup as shown in Figure 3.

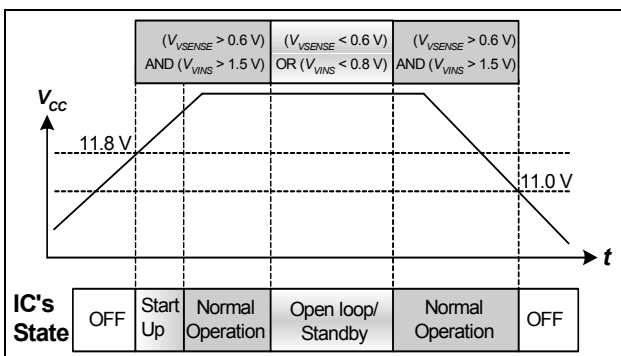

Figure 3 State of Operation respect to VCC

If VCC drops below 11V, the IC is off. The IC will then be consuming typically 300µA, whereas consuming 10mA during normal operation.

The IC can be turned off and forced into standby mode by pulling down the voltage at pin 6 (VSENSE) to lower than 0.6V. In this standby mode, the current consumption is reduced to 300µA. Other condition that can result in the standby mode is when a Brown-out condition occurs, ie pin 4 (VINS) <0.71V.

3.3 Start-up

Figure 4 shows the operation of voltage loop's OTA1 during startup. The VCOMP pin is pull internally to ground via switch S1 during UVLO and other fault conditions (see later section on "System Protection").

During power up when V_{OUT} is less than 83% of the rated level, OTA1 sources an output current, maximum 30µA into the compensation network at pin 5 (VCOMP) causing the voltage at this pin to rise linearly. This results in a controlled linear increase of the input current from 0A thus reducing the stress on the external component.

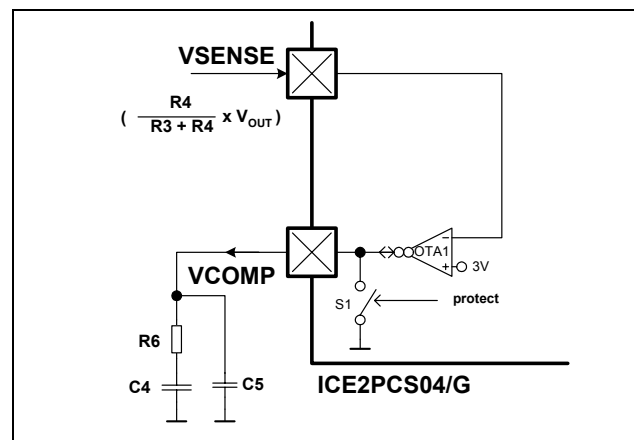

Figure 4 Startup Circuit

As V_{OUT} has not reached within 5% from the rated value, VCOMP voltage is level-shifted by the window detect block as shown in Figure 5, to ensure there is fast boost up output voltage.

When V_{OUT} approaches its rated value, OTA1's sourcing current drops and so does the level shift of the window detect block is removed. The normal voltage loop then takes control.

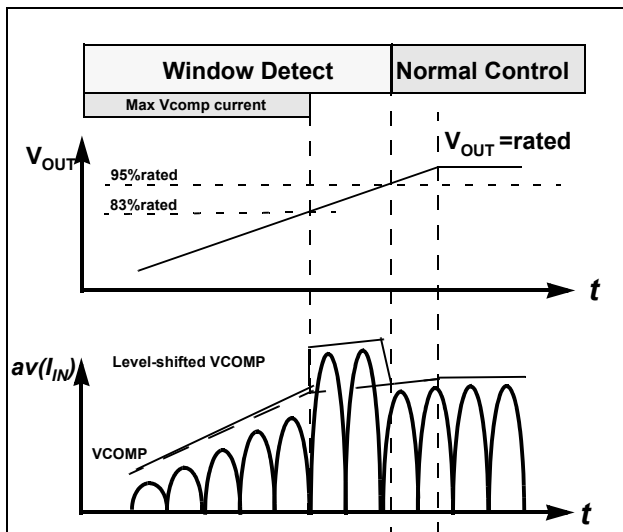

Figure 5 Startup with controlled maximum current

3.4 System Protection

The IC provides several protection features in order to ensure the PFC system in safe operating range:

- VCC Undervoltage Lockout (UVLO)
- Input Brown-out Detection (IBOP)
- Soft Over Current Control (SOC)
- Peak Current Limit (PCL)
- Open-Loop Detection (OLP)
- Output Over-Voltage Protection (OVP)

After the system is supplied with the correct level of VCC and V_{IN} , the system will enter into its normal mode of operation. Figure 6 shows situation when these protections features are active, as a function of the output voltage V_{OUT} .

An activation of the UVLO, IBOP and OLP results in the internal fault signal going high and brings the IC into the standby mode.

As the function of UVLO has already described in the earlier "Power Supply" section, the following sections continue to describe the functionality of these protection features.

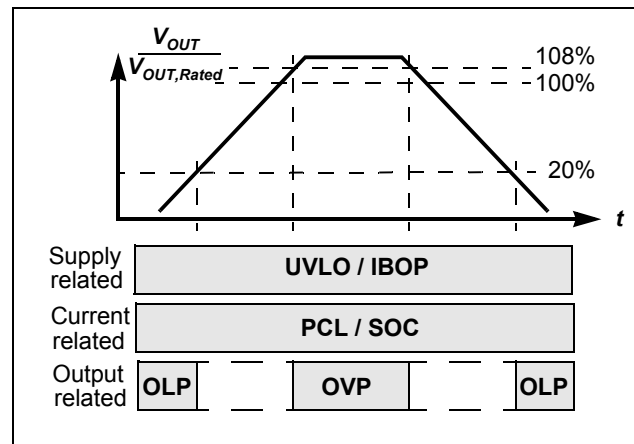

Figure 6 Protection Features

3.4.1 Input Brown-Out Protection (IBOP)

Brown-out occurs when the input voltage V_{IN} falls below the minimum input voltage of the design (i.e. 85V for universal input voltage range) and the VCC has not entered into the V_{CCUVLO} level yet. For a system without IBOP, the boost converter will increasingly draw a higher current from the mains at a given output power which may exceed the maximum design values of the input current.

ICE2PCS04/G provides a new IBOP feature whereby it senses directly the input voltage for Input Brown-Out condition via an external resistor/capacitor/diode network as shown in Figure 7. This network provides a filtered value of V_{IN} which turns the IC on when the voltage at pin 4 (VINS) is more than 1.5V. The IC enters into the standby mode when VINS goes below 0.71V. The hysteresis prevents the system to oscillate between normal and standby mode. Note also that V_{IN} needs to be at least 20% of the rated V_{OUT} in order to overcome OLP and powerup the system.

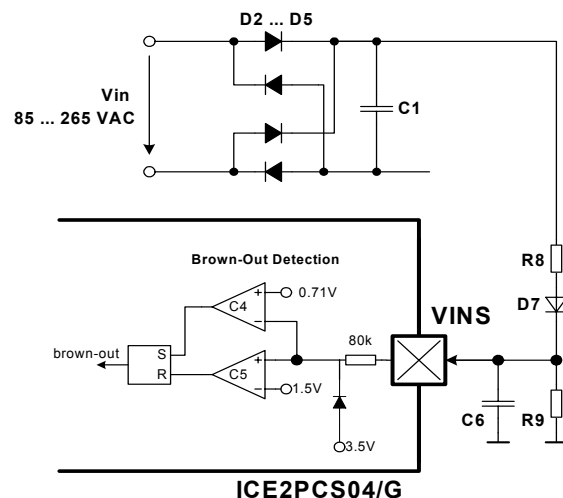

Figure 7 Input Brown-Out Protection (IBOP)

Functional Description

3.4.2 Soft Over Current Control (SOC)

The IC is designed **not** to support any output power that corresponds to a voltage lower than -0.75V at the ISENSE pin. A further increase in the inductor current, which results in a lower ISENSE voltage, will activate the Soft Over Current Control (SOC). This is a soft control as it does not directly switch off the gate drive. It acts on the nonlinear gain block to result in a reduced PWM duty cycle.

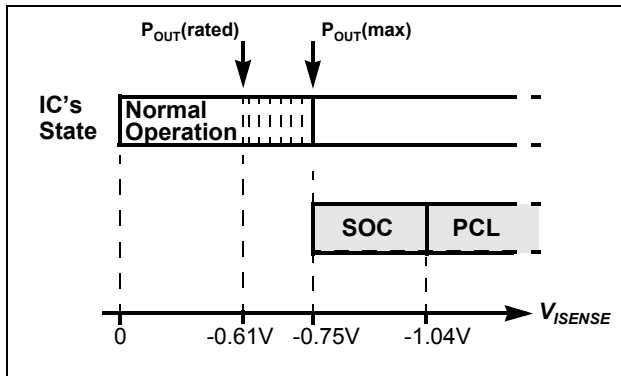

Figure 8 SOC and PCL Protection as function of V_{ISENSE}

The rated output power with a minimum V_{IN} (V_{INMIN}) is

$$P_{OUT(rated)} = V_{INMIN} \times \frac{0.61}{R1 \cdot \sqrt{2}}$$

Due to the internal parameter tolerance, the maximum power with V_{INMIN} is

$$P_{OUT(max)} = V_{INMIN} \times \frac{0.75}{R1 \cdot \sqrt{2}}$$

3.4.3 Peak Current Limit (PCL)

The IC provides a cycle by cycle peak current limitation (PCL). It is active when the voltage at pin 3 (ISENSE) reaches -1.04V. This voltage is amplified by OP1 by a factor of -1.43 and connected to comparator C2 with a reference voltage of 1.5V as shown in Figure 9. A deglitcher with 300ns after the comparator improves noise immunity to the activation of this protection.

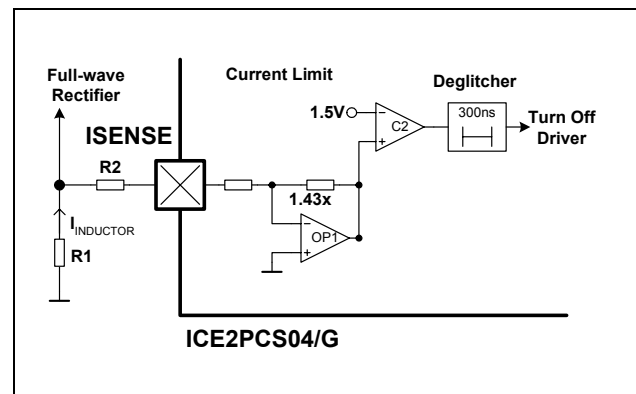

Figure 9 Peak Current Limit (PCL)

3.4.4 Open Loop Protection (OLP)

Whenever V_{SENSE} voltage falls below 0.6V, or equivalently V_{OUT} falls below 20% of its rated value, it indicates an open loop condition (i.e. V_{SENSE} pin not connected) or an insufficient input voltage V_{IN} for normal operation. In this case, most of the blocks within the IC will be shutdown. It is implemented using comparator C3 with a threshold of 0.6V as shown in the IC block diagram in Figure 2.

3.4.5 Over-Voltage Protection (OVP)

Whenever V_{OUT} exceeds the rated value by 5%, the over-voltage protection OVP is active as shown in Figure 6. This is implemented by sensing the voltage at pin V_{SENSE} with respect to a reference voltage of 3.15V. A V_{SENSE} voltage higher than 3.15V will immediately reduce the output duty cycle, bypassing the normal voltage loop control. This results in a lower input power to reduce the output voltage V_{OUT} . A V_{SENSE} voltage higher than 3.25V will immediately turn off the gate, thereby preventing damage to bus capacitor.

3.5 Fixed Switching Frequency

ICE2PCS04/G has an internally fixed switching frequency as opposed to the ICE2PCS01/G which can be externally set. This frequency is trimmed to 133kHz with an accuracy $\pm 5\%$ at 25°C.

Functional Description

3.6 Average Current Control

3.6.1 Complete Current Loop

The complete system current loop is shown in Figure 10.

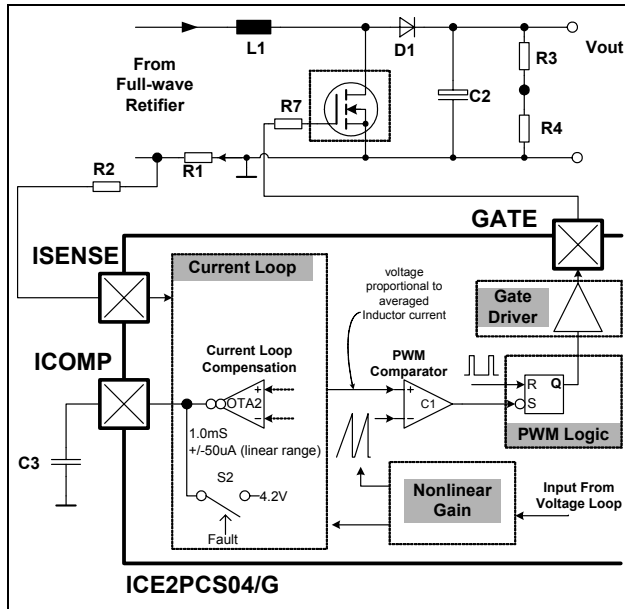

Figure 10 Complete System Current Loop

It consists of the current loop block which averages the voltage at pin ISENSE, resulted from the inductor current flowing across R1. The averaged waveform is compared with an internal ramp in the ramp generator and PWM block. Once the ramp crosses the average waveform, the comparator C1 turns on the driver stage through the PWM logic block. The Nonlinear Gain block defines the amplitude of the inductor current. The following sections describe the functionality of each individual blocks.

3.6.2 Current Loop Compensation

The compensation of the current loop is done at the ICOMP pin. This is the OTA2 output and a capacitor C3 has to be installed at this node to ground (see Figure 10). Under normal mode of operation, this pin gives a voltage which is proportional to the averaged inductor current. This pin is internally shorted to 4.2V in the event of standby mode.

3.6.3 Pulse Width Modulation (PWM)

The IC employs an average current control scheme in continuous conduction mode (CCM) to achieve the power factor correction.

Assuming the voltage loop is working and output voltage is kept constant, the off duty cycle D_{OFF} for a CCM PFC system is given as

$$D_{OFF} = \frac{V_{IN}}{V_{OUT}}$$

From the above equation, D_{OFF} is proportional to V_{IN} . The objective of the current loop is to regulate the average inductor current such that it is proportional to the off duty cycle D_{OFF} , and thus to the input voltage V_{IN} . Figure 11 shows the scheme to achieve the objective.

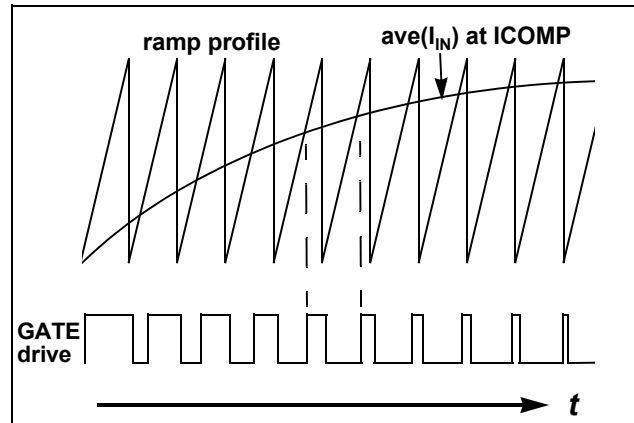

Figure 11 Average Current Control in CCM

The PWM is performed by the intersection of a ramp signal with the averaged inductor current at pin 5 (ICOMP). The PWM cycle starts with the Gate turn off for a duration of T_{OFFMIN} (400ns typ.) and the ramp is kept discharged. The ramp is then allowed to rise after T_{OFFMIN} expires. The off time of the boost transistor ends at the intersection of the ramp signal and the averaged current waveform. This results in the proportional relationship between the average current and the off duty cycle D_{OFF} .

Figure 12 shows the timing diagrams of T_{OFFMIN} and the PWM waveforms.

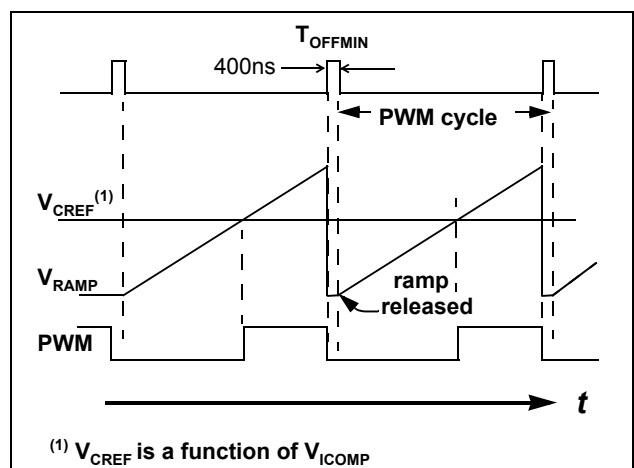

Figure 12 Ramp and PWM waveforms

3.6.4 Nonlinear Gain Block

The nonlinear gain block controls the amplitude of the regulated inductor current. The input of this block is the

Functional Description

voltage at pin VCOMP. This block has been designed to support the wide input voltage range (85-265VAC).

3.7 PWM Logic

The PWM logic block prioritizes the control input signals and generates the final logic signal to turn on the driver stage. The speed of the logic gates in this block, together with the width of the reset pulse T_{OFFMIN} , are designed to meet a maximum duty cycle D_{MAX} of 95% at the GATE output.

In case of high input currents which result in Peak Current Limitation, the GATE will be turned off immediately and maintained in off state for the current PWM cycle. The signal Toffmin resets (highest priority, overriding other input signals) both the current limit latch and the PWM on latch as illustrated in Figure 13.

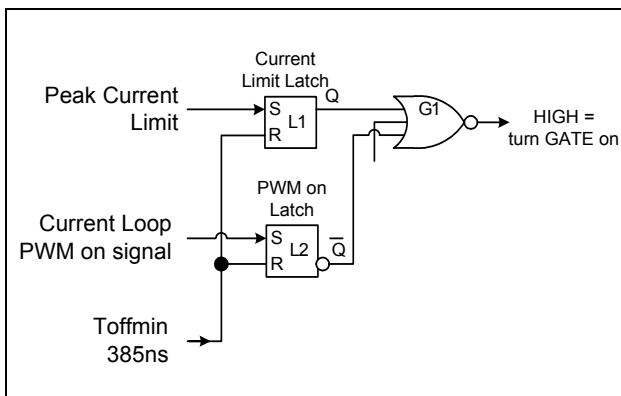

Figure 13 PWM Logic

3.8 Voltage Loop

The voltage loop is the outer loop of the cascaded control scheme which controls the PFC output bus voltage V_{OUT} . This loop is closed by the feedback sensing voltage at VSENSE which is a resistive divider tapping from V_{OUT} . The pin VSENSE is the input of OTA1 which has an accurate internal reference of 3V ($\pm 2\%$). Figure 14 shows the important blocks of this voltage loop.

3.8.1 Voltage Loop Compensation

The compensation of the voltage loop is installed at the VCOMP pin (see Figure 14). This is the output of OTA1 and the compensation must be connected at this pin to ground. The compensation is also responsible for the soft start function which controls an increasing AC input current during start-up.

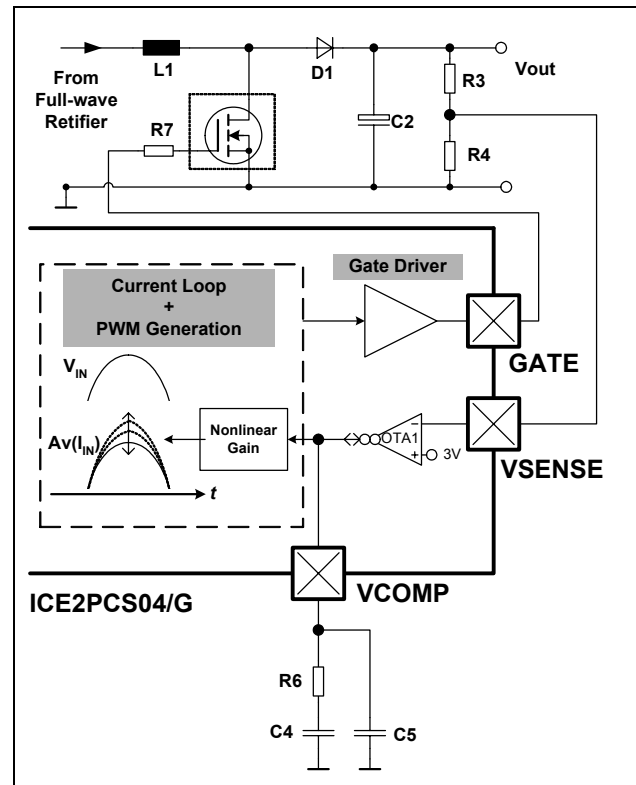

Figure 14 Voltage Loop

3.8.2 Enhanced Dynamic Response

Due to the low frequency bandwidth of the voltage loop, the dynamic response is slow and in the range of about several 10ms. This may cause additional stress to the bus capacitor and the switching transistor of the PFC in the event of heavy load changes.

The IC provides therefore a “window detector” for the feedback voltage V_{VSENSE} at pin 6 (VSENSE). Whenever V_{VSENSE} exceeds the reference value (3V) by $\pm 5\%$, it will act on the nonlinear gain block which in turn affect the gate drive duty cycle directly. This change in duty cycle is bypassing the slow changing VCOMP voltage, thus results in a fast dynamic response of V_{OUT} .

3.9 Output Gate Driver

The output gate driver is a fast totem pole gate drive. It has an in-built cross conduction currents protection and a Zener diode Z1 (see Figure 15) to protect the external transistor switch against undesirable over voltages. The maximum voltage at pin 8 (GATE) is typically clamped at 15V.

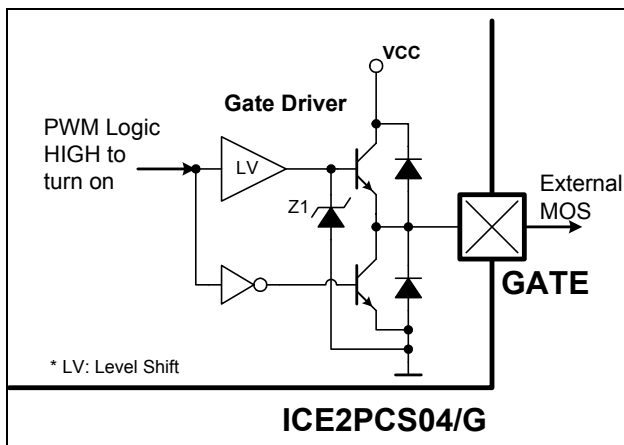

Figure 15 Gate Driver

The output is active HIGH and at VCC voltages below the under voltage lockout threshold V_{CCUVLO} , the gate drive is internally pull low to maintain the off state.

4 Electrical Characteristics

4.1 Absolute Maximum Ratings

Note: Absolute maximum ratings are defined as ratings, which when being exceeded may lead to destruction of the integrated circuit.

Parameter	Symbol	Limit Values		Unit	Remarks
		min.	max.		
V_{CC} Supply Voltage	V_{CC}	-0.3	25	V	
VINS Voltage	V_{VINS}	-0.3	9.5	V	³⁾
VINS Current	I_{INS}	-1	35	uA	
ICOMP Voltage	V_{ICOMP}	-0.3	5	V	
ISENSE Voltage	V_{ISENSE}	-20	5	V	²⁾
ISENSE Current	I_{ISENSE}	-1	1	mA	Recommended $R2=220\Omega$
VSENSE Voltage	V_{VSENSE}	-0.3	5	V	
VSENSE Current	I_{VSENSE}	-1	1	mA	$R3>400k\Omega$
VCOMP Voltage	V_{VCOMP}	-0.3	5	V	
GATE Voltage	V_{GATE}	-0.3	17	V	Clamped at 15V(typ) if driven internally.
Junction Temperature	T_j	-40	150	°C	
Storage Temperature	T_s	-55	150	°C	
Thermal Resistance Junction-Ambient for PG-DSO-8	$R_{thJA}(DSO)$	-	185	K/W	PG-DSO-8
Thermal Resistance Junction-Ambient for PG-DIP-8	$R_{thJA}(DIP)$	-	90	K/W	PG-DIP-8
ESD Protection	V_{ESD}	-	2	kV	Human Body Model ¹⁾

¹⁾ According to EIA/JESD22-A114-B (discharging a 100pF capacitor through a 1.5k Ω series resistor)

²⁾ Absolute ISENSE current should not be exceeded

³⁾ Absolute VINS current should not be exceeded

4.2 Operating Range

Note: Within the operating range the IC operates as described in the functional description.

Parameter	Symbol	Limit Values		Unit	Remarks
		min.	max.		
V_{CC} Supply Voltage	V_{CC}	V_{CCUVLO}	25	V	
Junction Temperature	T_{JCon}	-40	125	°C	

Electrical Characteristics
4.3 Characteristics

Note: The electrical characteristics involve the spread of values within the specified supply voltage and junction temperature range T_j from $-40\text{ }^{\circ}\text{C}$ to $125\text{ }^{\circ}\text{C}$. Typical values represent the median values, which are related to $25\text{ }^{\circ}\text{C}$. If not otherwise stated, a supply voltage of $V_{CC} = 18\text{V}$ is assumed for test condition.

4.3.1 Supply Section

Parameter	Symbol	Limit Values			Unit	Test Condition
		min.	typ.	max.		
VCC Turn-On Threshold	V_{CCon}	11.4	11.8	12.7	V	
VCC Turn-Off Threshold/ Under Voltage Lock Out	V_{CCUVLO}	10.4	11.0	11.7	V	
VCC Turn-On/Off Hysteresis	V_{CChy}	0.65	0.8	1.4	V	
Start Up Current Before V_{CCon}	$I_{CCstart}$	-	450	1100	μA	$V_{VCC} = V_{VCCon} - 0.1\text{V}$
Operating Current with active GATE	I_{CCHG}	-	10	20	mA	$C_L = 4.7\text{nF}$
Operating Current during Standby	$I_{CCStdby}$	-	700	1300	μA	$V_{VSENSE} = 0.5\text{V}$ $V_{ICOMP} = 4\text{V}$

4.3.2 PWM Section

Parameter	Symbol	Limit Values			Unit	Test Condition
		min.	typ.	max.		
Fixed Oscillator Frequency	f_{SW}	118	133	138	kHz	
Max. Duty Cycle	D_{MAX}	92	95	98.5	%	
Min. Duty Cycle	D_{MIN}			0	%	$V_{VCOMP} = 0\text{V}$, $V_{VSENSE} = 3\text{V}$ $V_{ICOMP} = 4.3\text{V}$
Min. Off Time	T_{OFFMIN}	150	400	650	ns	$V_{VSENSE} = 3\text{V}$ $V_{ISENSE} = 0.1\text{V}$

Electrical Characteristics
4.3.3 System Protection Section

Parameter	Symbol	Limit Values			Unit	Test Condition
		min.	typ.	max.		
Open Loop Protection (OLP) VSENSE Threshold	V_{OLP}	0.55	0.6	0.65	V	
Peak Current Limitation (PCL) ISENSE Threshold	V_{PCL}	-1.16	-1.04	-0.95	V	
Soft Over Current Control (SOC) ISENSE Threshold	V_{SOC}	-0.75	-0.68	-0.61	V	
Output Over-Voltage Protection (OVP)	V_{OVP}	3.1	3.25	3.4	V	
Input Brown-out Protection (IBOP) High to Low Threshold	V_{VINSL}	0.64	0.71	0.77	V	
Input Brown-out Protection (IBOP) Low to High Threshold	V_{VINSH}	1.46	1.50	1.57	V	
Input Brown-out Protection (IBOP) VINS Bias Current	I_{VINOV}	-1	-0.2	1	μ A	$V_{VINS} = 0V$

4.3.4 Current Loop Section

Parameter	Symbol	Limit Values			Unit	Test Condition
		min.	typ.	max.		
OTA2 Transconductance Gain	Gm_{OTA2}	0.8	1.0	1.3	mS	At Temp = 25°C
OTA2 Output Linear Range ¹⁾	I_{OTA2}	-	± 50	-	μ A	
ICOMP Voltage during OLP	V_{ICOMP}	3.9	4.2	-	V	$V_{VSENSE} = 0.5V$

¹⁾ The parameter is not subject to production test - verified by design/characterization

Electrical Characteristics
4.3.5 Voltage Loop Section

Parameter	Symbol	Limit Values			Unit	Test Condition
		min.	typ.	max.		
OTA1 Reference Voltage	V_{OTA1}	2.92	3.00	3.08	V	measured at VSENSE
OTA1 Transconductance Gain	G_{mOTA1}	26	39	51	μ S	
OTA1 Max. Source Current Under Normal Operation	I_{OTA1SO}	18	30	38	μ A	$V_{VSENSE} = 2V$ $V_{VCOMP} = 3V$
OTA1 Max. Sink Current Under Normal Operation	I_{OTA1SK}	21	30	41	μ A	$V_{VSENSE} = 4V$ $V_{VCOMP} = 3V$
Enhanced Dynamic Response VSENSE High Threshold	V_{Hi}	3.09	3.18	3.26	V	
VSENSE Low Threshold	V_{Lo}	2.76	2.85	2.94	V	
VSENSE Input Bias Current at 3V	I_{VSEN5V}	0	-	1.5	μ A	$V_{VSENSE} = 3V$
VSENSE Input Bias Current at 1V	I_{VSEN1V}	0	-	1	μ A	$V_{VSENSE} = 1V$
VCOMP Voltage during OLP	V_{VCOMP}	0	0.2	0.4	V	$V_{VSENSE} = 0.5V$ $I_{VCOMP} = 0.5mA$

Electrical Characteristics
4.3.6 Driver Section

Parameter	Symbol	Limit Values			Unit	Test Condition
		min.	typ.	max.		
GATE Low Voltage	V_{GATEL}	-	-	1.2	V	$V_{CC} = 10V$ $I_{GATE} = 5 \text{ mA}$
		-		1.5	V	$V_{CC} = 10V$ $I_{GATE} = 20 \text{ mA}$
		-	0.4	-	V	$I_{GATE} = 0 \text{ A}$
		-	-	1.0	V	$I_{GATE} = 20 \text{ mA}$
		-0.2	0	-	V	$I_{GATE} = -20 \text{ mA}$
GATE High Voltage	V_{GATEH}	-	14.8	-	V	$V_{CC} = 25V$ $C_L = 4.7\text{nF}$
		-	14.8	-	V	$V_{CC} = 19V$ $C_L = 4.7\text{nF}$
		7.8	9.2	-	V	$V_{CC} = V_{VCCoff} + 0.2V$ $C_L = 4.7\text{nF}$
GATE Rise Time	t_r	-	60	-	ns	$V_{Gate} = 2V \dots 12V$ $C_L = 4.7\text{nF}$
GATE Fall Time	t_f	-	50	-	ns	$V_{Gate} = 12V \dots 2V$ $C_L = 4.7\text{nF}$
GATE Current, Peak, Rising Edge	I_{GATE}	-1.5	-	-	A	$C_L = 4.7\text{nF}^{1)}$
GATE Current, Peak, Falling Edge	I_{GATE}	-	-	2.0	A	$C_L = 4.7\text{nF}^{1)}$

1) Design characteristics (not meant for production testing)

5 Outline Dimension

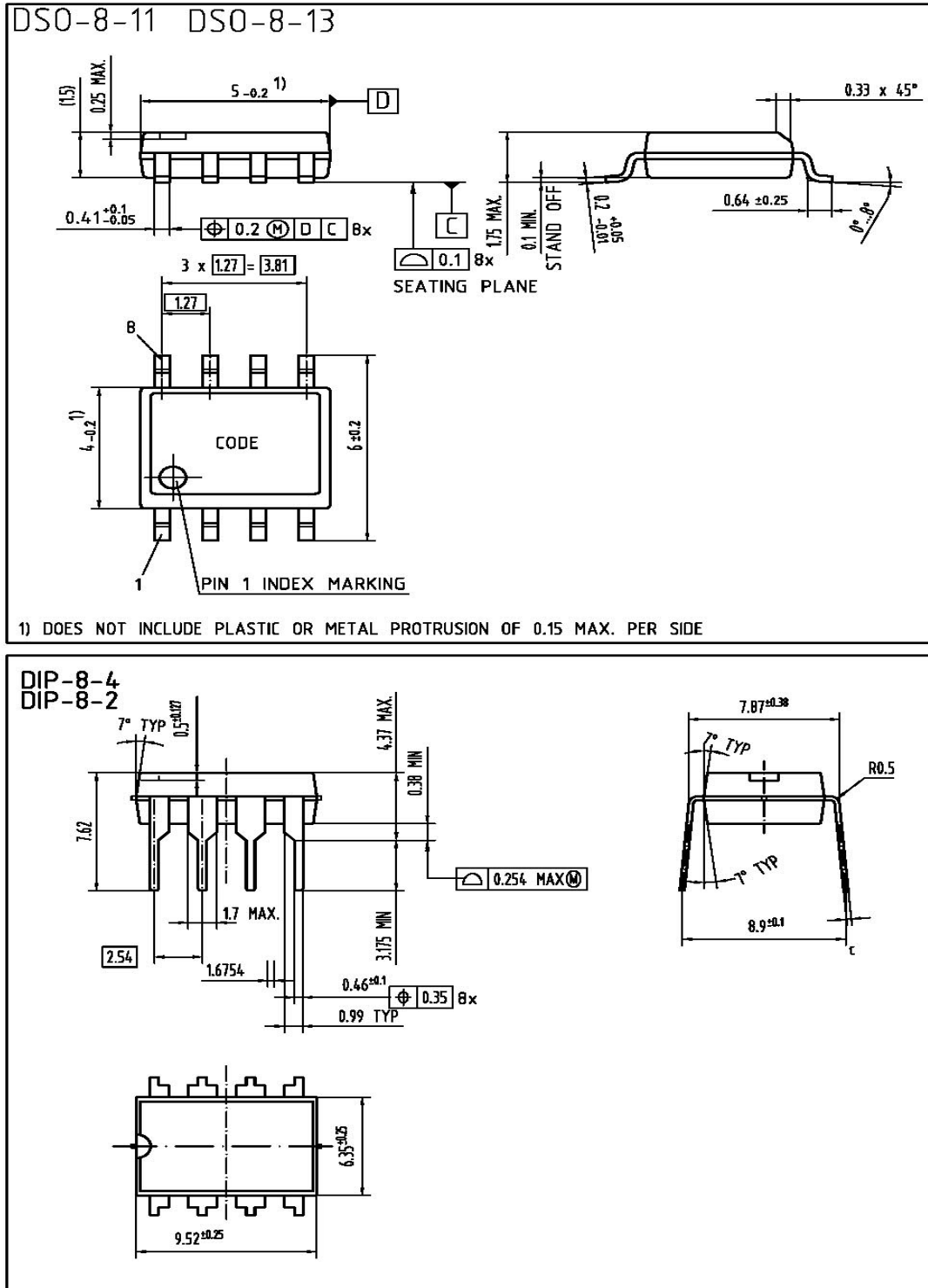

Figure 16 PG-DSO-8 and PG-DIP-8 Outline Dimension

Total Quality Management

Qualität hat für uns eine umfassende Bedeutung. Wir wollen allen Ihren Ansprüchen in der bestmöglichen Weise gerecht werden. Es geht uns also nicht nur um die Produktqualität – unsere Anstrengungen gelten gleichermaßen der Lieferqualität und Logistik, dem Service und Support sowie allen sonstigen Beratungs- und Betreuungsleistungen.

Dazu gehört eine bestimmte Geisteshaltung unserer Mitarbeiter. Total Quality im Denken und Handeln gegenüber Kollegen, Lieferanten und Ihnen, unserem Kunden. Unsere Leitlinie ist jede Aufgabe mit „Null Fehlern“ zu lösen – in offener Sichtweise auch über den eigenen Arbeitsplatz hinaus – und uns ständig zu verbessern.

Unternehmensweit orientieren wir uns dabei auch an „top“ (Time Optimized Processes), um Ihnen durch größere Schnelligkeit den entscheidenden Wettbewerbsvorsprung zu verschaffen.

Geben Sie uns die Chance, hohe Leistung durch umfassende Qualität zu beweisen.

Wir werden Sie überzeugen.

Quality takes on an all-encompassing significance at Semiconductor Group. For us it means living up to each and every one of your demands in the best possible way. So we are not only concerned with product quality. We direct our efforts equally at quality of supply and logistics, service and support, as well as all the other ways in which we advise and attend to you.

Part of this is the very special attitude of our staff. Total Quality in thought and deed, towards co-workers, suppliers and you, our customer. Our guideline is “do everything with zero defects”, in an open manner that is demonstrated beyond your immediate workplace, and to constantly improve.

Throughout the corporation we also think in terms of Time Optimized Processes (top), greater speed on our part to give you that decisive competitive edge.

Give us the chance to prove the best of performance through the best of quality – you will be convinced.

<http://www.infineon.com>