

Super FAP-G Series

N-CHANNEL SILICON POWER MOSFET

Features

- High speed switching
- No secondary breakdown
- Avalanche-proof
- Low on-resistance
- Low driving power

Applications

- Switching regulators
- UPS (Uninterruptible Power Supply)
- DC-DC converters

Maximum ratings and characteristic Absolute maximum ratings (Tc=25°C unless otherwise specified)

| Item | Symbol | Ratings | Unit | Remarks |
|---|-------------------------------------|---------------------|-------|------------------------|
| Drain-source voltage | V _{DS} | 120 | V | |
| | V _{D SX} | 90 | V | V _{GS} =-30V |
| Continuous drain current | I _D | 67 | A | |
| Pulsed drain current | I _{D(puls)} | ±268 | A | |
| Gate-source voltage | V _{GS} | ±30 | V | |
| Repetitive or non-repetitive | I _{AR} | 67 | A | Note *1 |
| Non-repetitive Maximum avalanche energy | E _{AS} | 719.1 | mJ | Note *2 |
| Repetitive Maximum avalanche energy | | 27.0 | mJ | Note *3 |
| Maximum drain-source dV/dt | dV _{DS} /dt | 20 | kV/μs | V _{DS} ≤ 120V |
| Peak diode recovery dV/dt | dV/dt | 5 | kV/μs | Note *4 |
| Maximum power dissipation | P _D | 2.02 | W | T _a =25°C |
| | | 270 | W | T _c =25°C |
| Operating and storage temperature range | T _{ch} T _{stg} | +150 -55 to +150 | °C | |

Note *1 T_{ch} ≤ 150°C

Note *2 Starting T_{ch}=25°C, I_{AS}=27A, L=1.32mH, V_{CC}=48V, R_G=50Ω
E_{AS} limited by maximum channel temperature and avalanche current.
See to 'Avalanche Energy' graph.

Note *3 Repetitive rating: Pulse width limited by maximum channel temperature.
See to 'Transient Thermal Impedance' graph.

Note *4 I_F ≤ -I_D, -di/dt=50A/μs, V_{CC} ≤ BV_{DSS}, T_{ch} ≤ 150°C

Outline Drawings [mm]

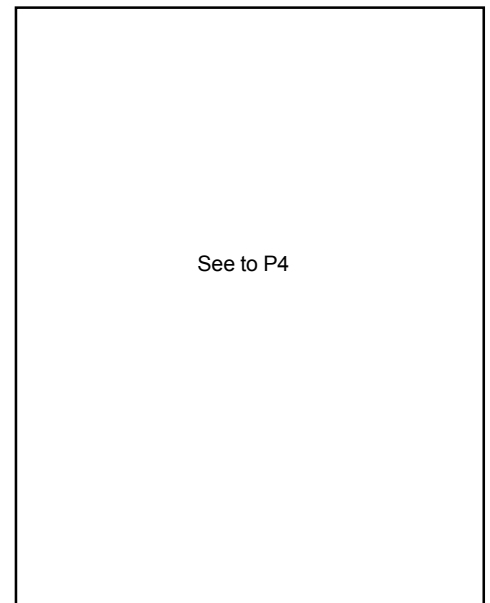

Equivalent circuit schematic

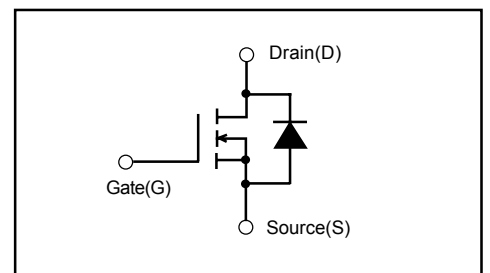

Electrical characteristics (T_c = 25°C unless otherwise specified)

| Item | Symbol | Test Conditions | Min. | Typ. | Max. | Units |
|----------------------------------|----------------------|--|------|------|------|-------|
| Drain-source breakdown voltage | V _{(BR)DSS} | I _D = 250μA V _{GS} =0V | 120 | | | V |
| Gate threshold voltage | V _{GS(th)} | I _D = 250μA V _D =V _{GS} | 3.0 | | 5.0 | V |
| Zero gate voltage drain current | I _{DSS} | V _D =120V V _{GS} =0V T _{ch} =25°C | | | 25 | μA |
| | | V _D =96V V _{GS} =0V T _{ch} =125°C | | | 250 | |
| Gate-source leakage current | I _{GSS} | V _{GS} =±30V V _D =0V | | | 100 | nA |
| Drain-source on-state resistance | R _{DS(on)} | I _D =33.5A V _{GS} =10V | | 24.6 | 30.0 | mΩ |
| Forward transconductance | g _{fs} | I _D =33.5A V _D =25V | 14 | 28 | | S |
| Input capacitance | C _{iss} | V _D =75V | | 1880 | 2820 | pF |
| Output capacitance | C _{oss} | V _{GS} =0V | | 360 | 540 | |
| Reverse transfer capacitance | C _{rss} | f=1MHz | | 30 | 45 | |
| Turn-on time t _{on} | td(on) | V _{CC} =48V I _D =33.5A | | 20 | 30 | ns |
| | t _r | V _{GS} =10V | | 35 | 53 | |
| Turn-off time t _{off} | td(off) | R _G =10 Ω | | 50 | 75 | |
| | t _r | | | 23 | 35 | |
| Total Gate Charge | Q _G | V _{CC} =60V | | 52 | 78 | nC |
| Gate-Source Charge | Q _{GS} | I _D =67A | | 16 | 24 | |
| Gate-Drain Charge | Q _{GD} | V _{GS} =10V | | 18 | 27 | |
| Diode forward on-voltage | V _{SD} | I _F =67A V _{GS} =0V T _{ch} =25°C | | 1.10 | 1.50 | V |
| Reverse recovery time | t _{rr} | I _F =67A V _{GS} =0V | | 150 | | ns |
| Reverse recovery charge | Q _{rr} | -di/dt=100A/μs T _{ch} =25°C | | 0.9 | | μC |

Thermal characteristics

| Item | Symbol | Test Conditions | Min. | Typ. | Max. | Units |
|--------------------|-----------------------|--------------------|------|------|-------|-------|
| Thermal resistance | R _{th(ch-c)} | channel to case | | | 0.463 | °C/W |
| | R _{th(ch-a)} | channel to ambient | | | 62.0 | °C/W |

■ Characteristics

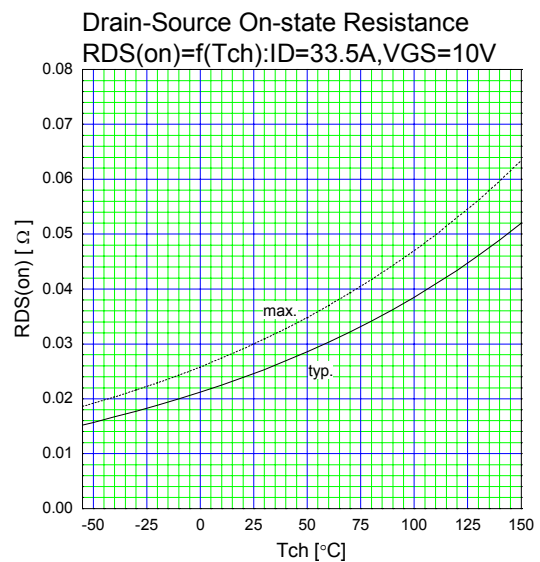
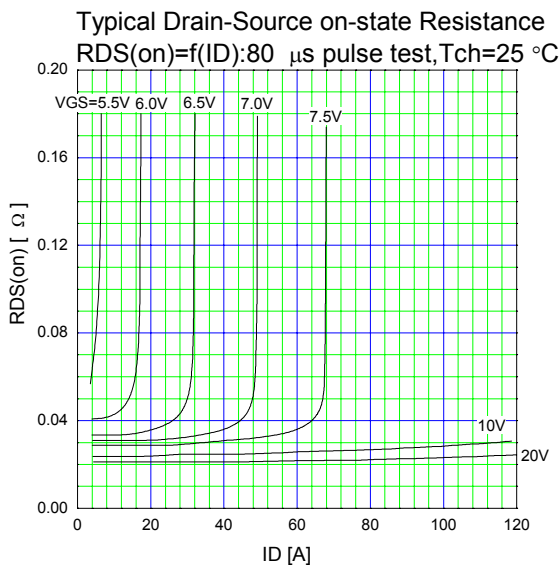
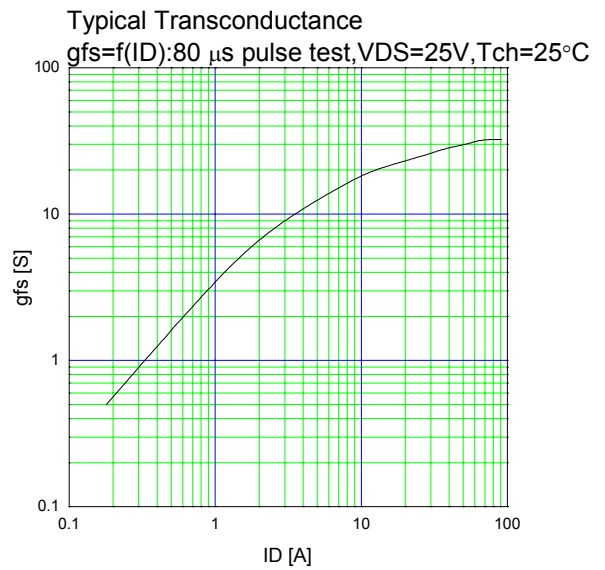
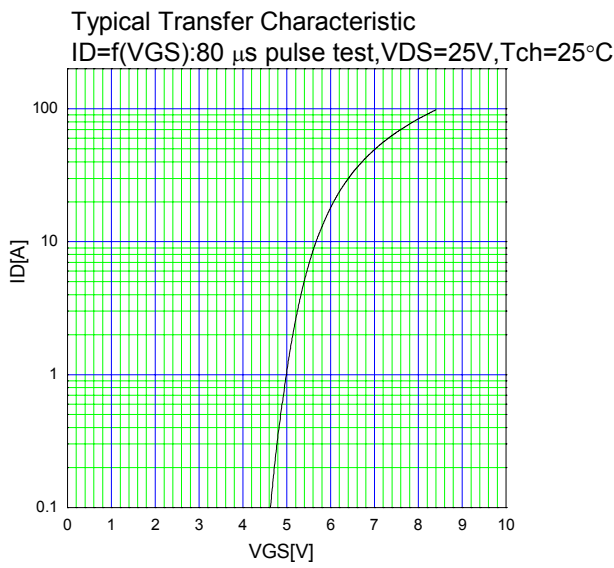
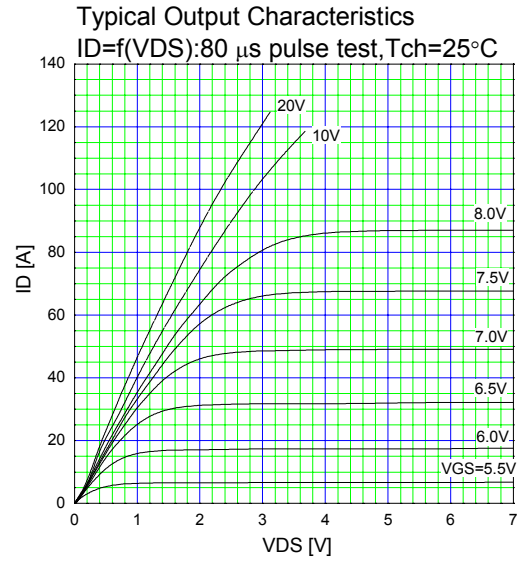
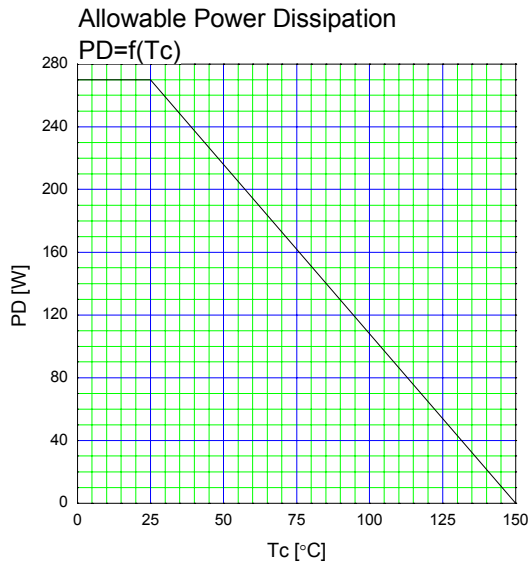

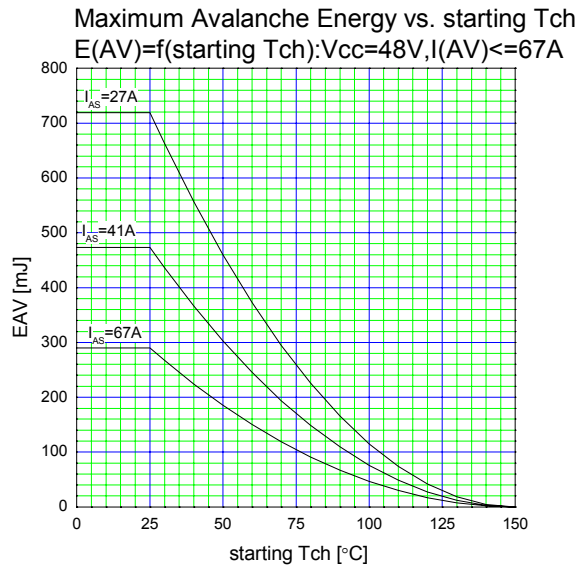
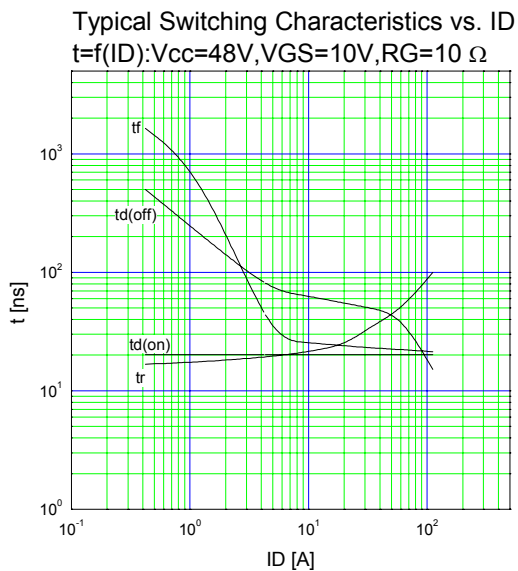
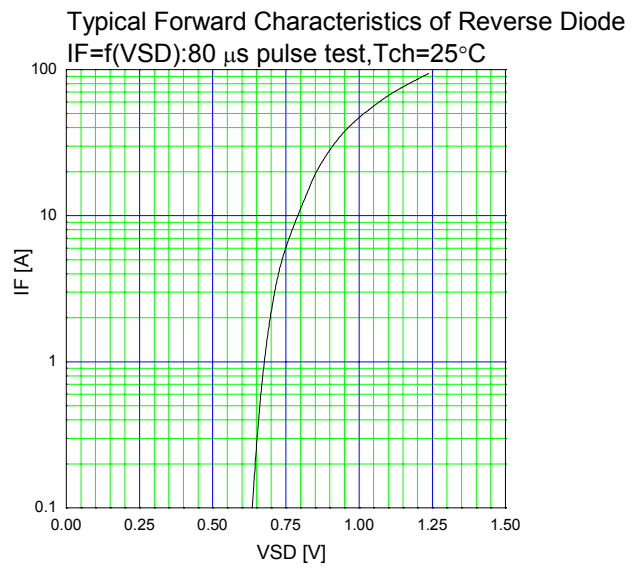
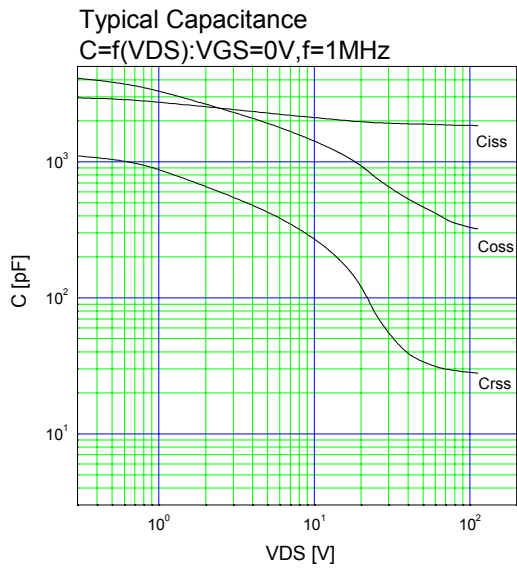
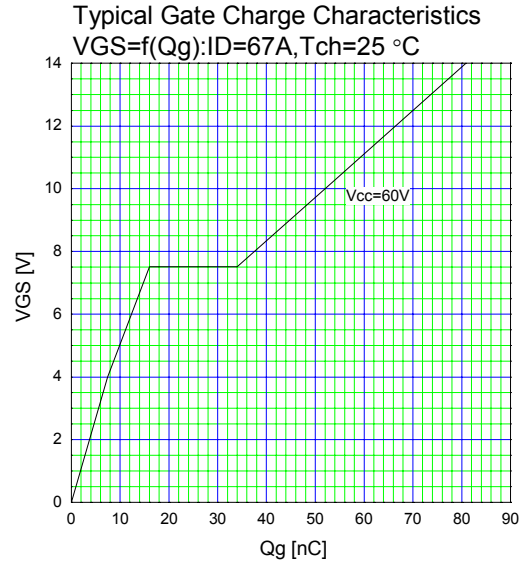
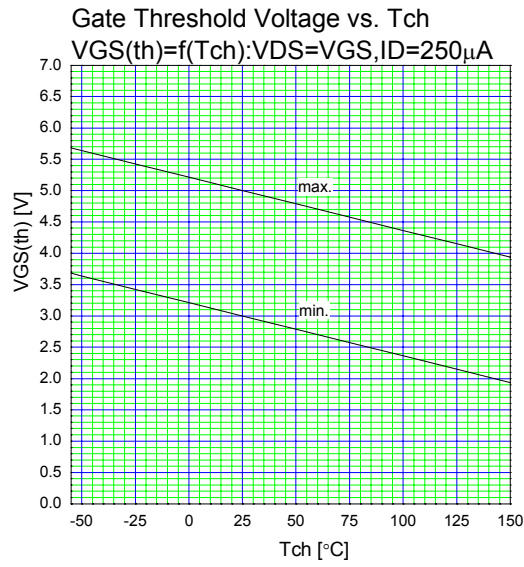

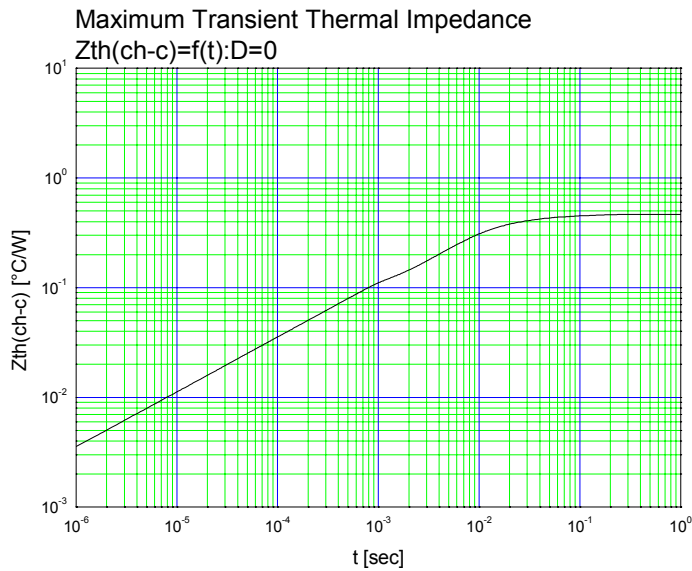
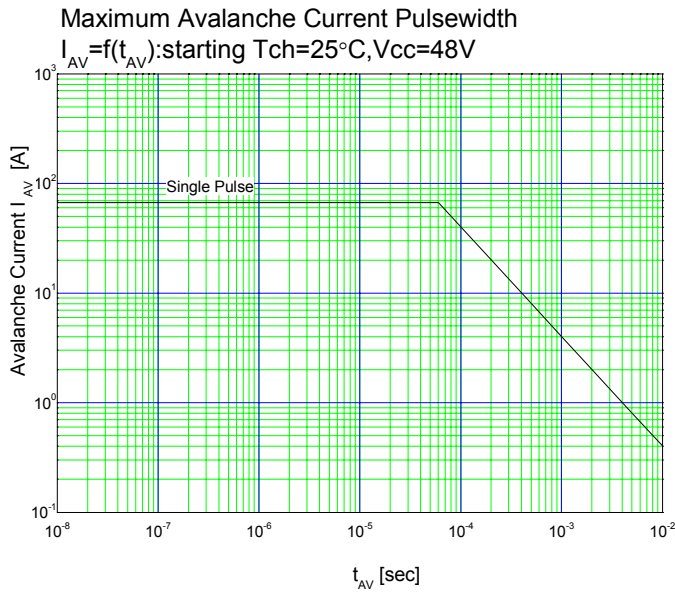

Outline Drawings [mm]

T-pack(L)

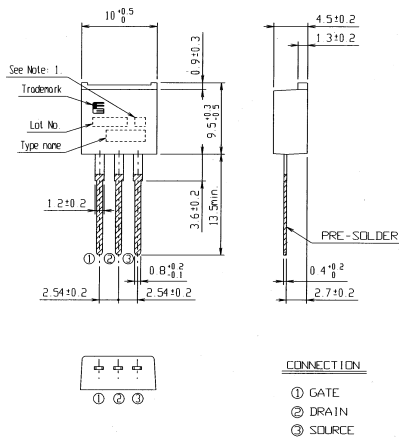

Note: 1. Guaranteed mark of avalanche ruggedness.

T-pack(S)

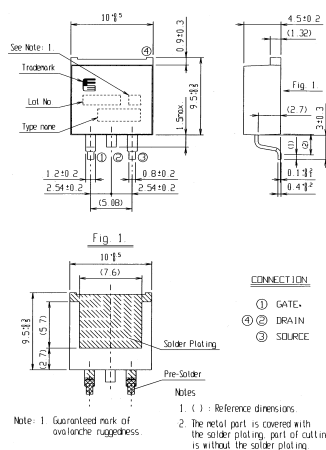

Note: 1. Guaranteed mark of avalanche ruggedness.

T-pack(SJ) [D2-pack]

