

High-Voltage — High Power Transistors

... designed for use in high power audio amplifier applications and high voltage switching regulator circuits.

- High Collector–Emitter Sustaining Voltage —

NPN	PNP
$V_{CEO(sus)} = 160 \text{ Vdc}$	$V_{CEO(sus)} = 160 \text{ Vdc}$
MJE4343	MJE4353
- High DC Current Gain — @ $I_C = 8.0 \text{ Adc}$ $h_{FE} = 35$ (Typ)
- Low Collector–Emitter Saturation Voltage —

$V_{CE(sat)} = 2.0 \text{ Vdc (Max)}$
@ $I_C = 8.0 \text{ Adc}$

• These devices are available in Pb-free package(s). Specifications herein apply to both standard and Pb-free devices. Please see our website at www.onsemi.com for specific Pb-free orderable part numbers, or contact your local ON Semiconductor sales office or representative.

MAXIMUM RATINGS

Rating	Symbol	Max	Unit
Collector–Emitter Voltage	V_{CEO}	160	Vdc
Collector–Base Voltage	V_{CB}	160	Vdc
Emitter–Base Voltage	V_{EB}	7.0	Vdc
Collector Current — Continuous Peak (1)	I_C	16 20	Adc
Base Current — Continuous	I_B	5.0	Adc
Total Power Dissipation @ $T_C = 25^\circ\text{C}$	P_D	125	Watts
Operating and Storage Junction Temperature Range	T_J, T_{stg}	-65 to +150	$^\circ\text{C}$

THERMAL CHARACTERISTICS

Characteristic	Symbol	Max	Unit
Thermal Resistance, Junction to Case	$R_{\theta JC}$	1.0	$^\circ\text{C/W}$

(1) Pulse Test: Pulse Width $\leq 5.0 \mu\text{s}$, Duty Cycle $\geq 10\%$.

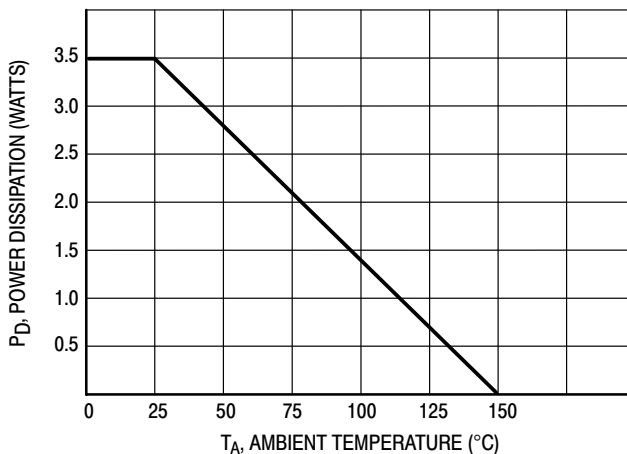

**Figure 1. Power Derating
Reference: Ambient Temperature**

**NPN
MJE4343
PNP
MJE4353**

**16 AMPERE
POWER TRANSISTORS
COMPLEMENTARY
SILICON
160 VOLTS**

**CASE 340D-02
TO-218 TYPE**

MJE4343 MJE4353

ELECTRICAL CHARACTERISTICS ($T_C = 25^\circ\text{C}$ unless otherwise noted)

Characteristic	Symbol	Min	Max	Unit
OFF CHARACTERISTICS				
Collector–Emitter Sustaining Voltage (1) ($I_C = 200\text{ mA}$, $I_B = 0$)	$V_{CEO(sus)}$	160	—	Vdc
Collector–Emitter Cutoff Current ($V_{CE} = 80\text{ Vdc}$, $I_B = 0$)	I_{CEO}	—	750	μA
Collector–Emitter Cutoff Current ($V_{CE} = \text{Rated } V_{CB}$, $V_{EB(off)} = 1.5\text{ Vdc}$) ($V_{CE} = \text{Rated } V_{CB}$, $V_{EB(off)} = 1.5\text{ Vdc}$, $T_C = 150^\circ\text{C}$)	I_{CEX}	— —	1.0 5.0	mA
Collector–Base Cutoff Current ($V_{CB} = \text{Rated } V_{CB}$, $I_E = 0$)	I_{CBO}	—	750	μA
Emitter–Base Cutoff Current ($V_{BE} = 7.0\text{ Vdc}$, $I_C = 0$)	I_{EBO}	—	1.0	mA
ON CHARACTERISTICS (1)				
DC Current Gain ($I_C = 8.0\text{ A}$, $V_{CE} = 2.0\text{ Vdc}$) ($I_C = 16\text{ A}$, $V_{CE} = 4.0\text{ Vdc}$)	h_{FE}	15 8.0	35 (Typ) 15 (Typ)	—
Collector–Emitter Saturation Voltage ($I_C = 8.0\text{ A}$, $I_B = 800\text{ mA}$) ($I_C = 16\text{ A}$, $I_B = 2.0\text{ A}$)	$V_{CE(sat)}$	— —	2.0 3.5	Vdc
Base–Emitter Saturation Voltage ($I_C = 16\text{ A}$, $I_B = 2.0\text{ A}$)	$V_{BE(sat)}$	—	3.9	Vdc
Base–Emitter On Voltage ($I_C = 16\text{ A}$, $V_{CE} = 4.0\text{ Vdc}$)	$V_{BE(on)}$	—	3.9	Vdc
DYNAMIC CHARACTERISTICS				
Current–Gain — Bandwidth Product (2) ($I_C = 1.0\text{ A}$, $V_{CE} = 20\text{ Vdc}$, $f_{test} = 0.5\text{ MHz}$)	f_T	1.0	—	MHz
Output Capacitance ($V_{CB} = 10\text{ Vdc}$, $I_E = 0$, $f = 0.1\text{ MHz}$)	C_{ob}	—	800	pF

(1) Pulse Test: Pulse Width $\leq 300\ \mu\text{s}$, Duty Cycle $\geq 2.0\%$.

(2) $f_T = |h_{fe}| \cdot f_{test}$.

MJE4343 MJE4353

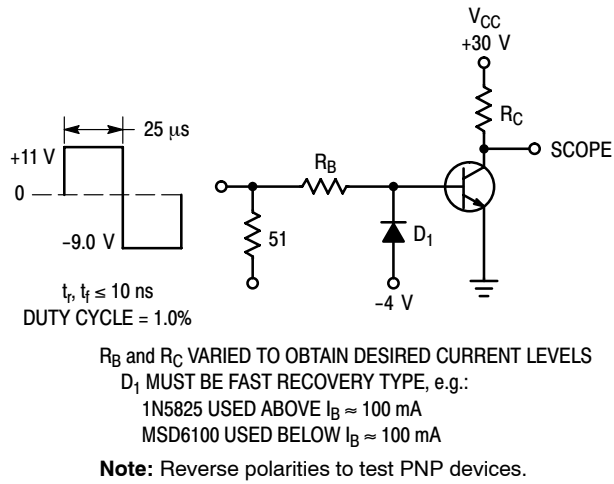

Figure 2. Switching Times Test Circuit

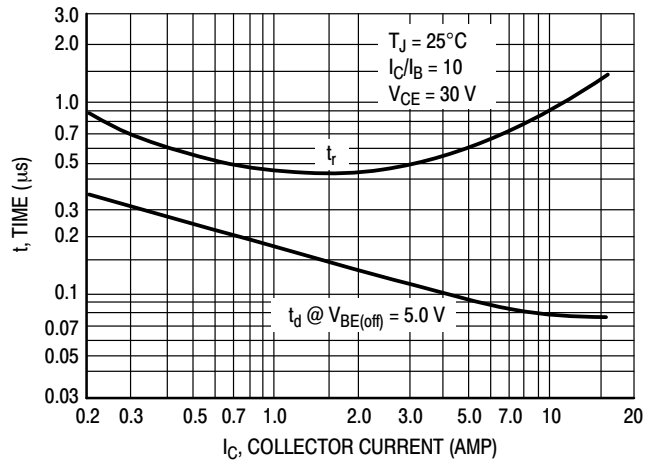

Figure 3. Typical Turn-On Time

TYPICAL CHARACTERISTICS

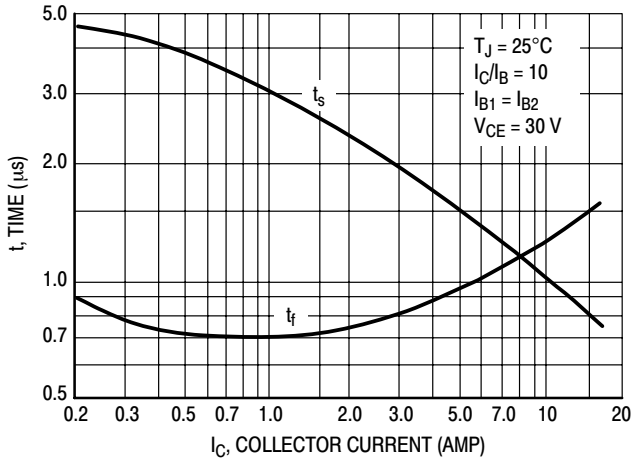

Figure 4. Turn-Off Time

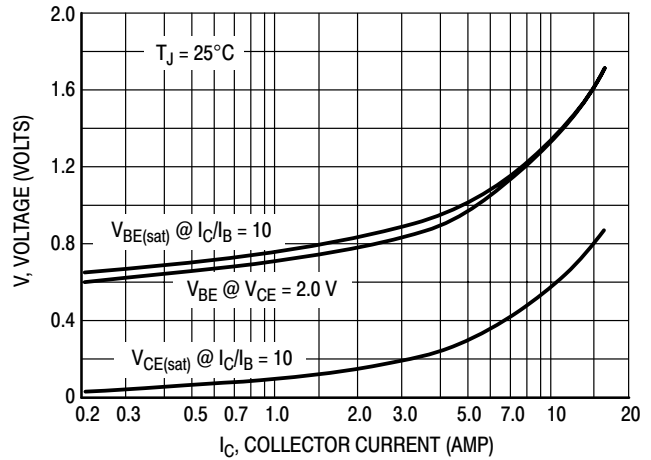

Figure 5. On Voltages

MJE4343 MJE4353

DC CURRENT GAIN

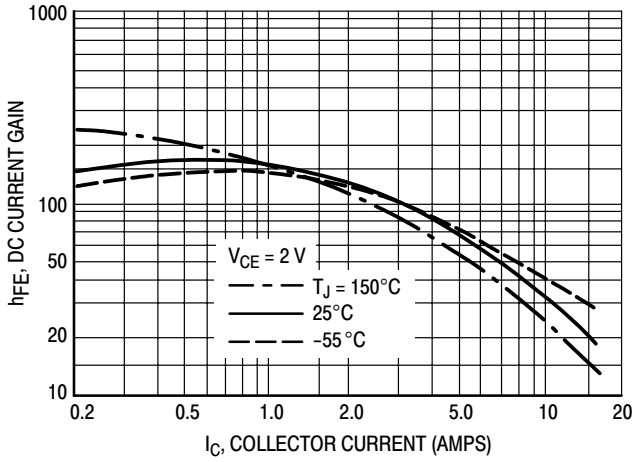

Figure 6. MJE4340 Series (NPN)

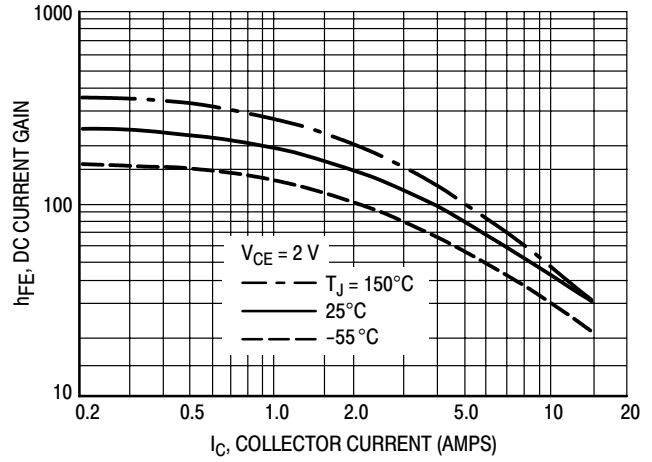

Figure 7. MJE4350 Series (PNP)

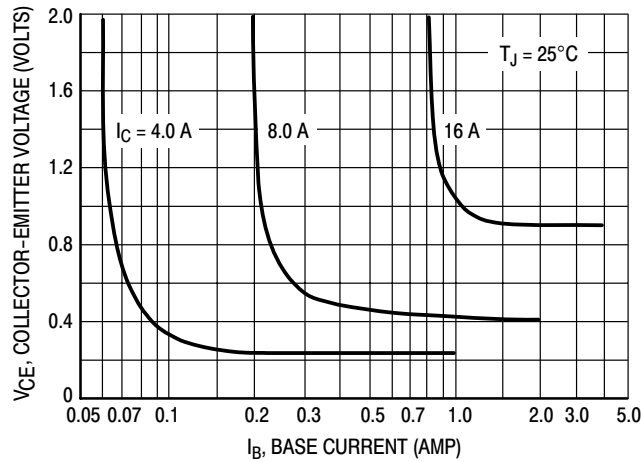

Figure 8. Collector Saturation Region

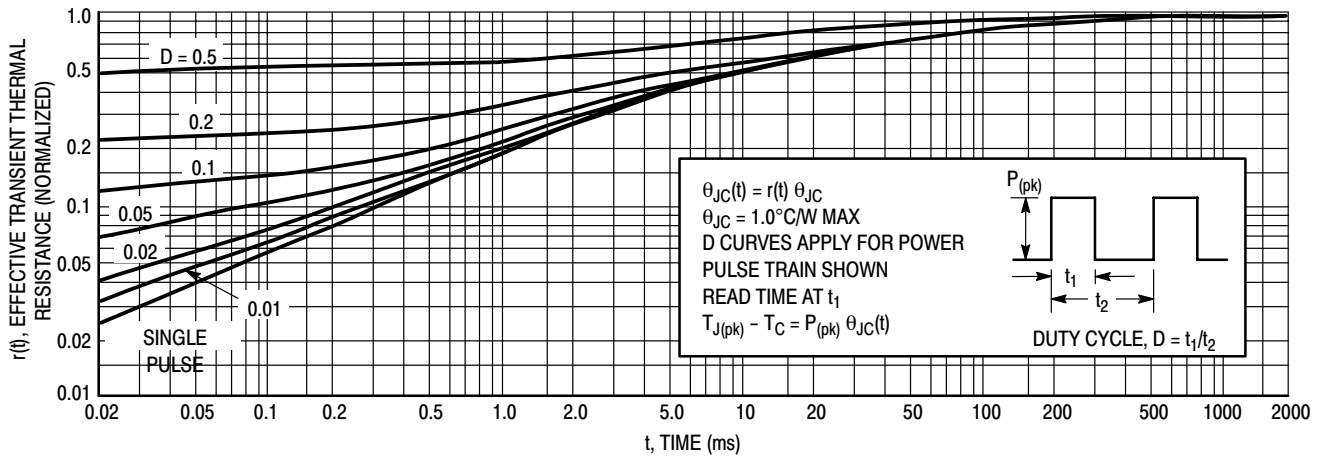

Figure 9. Thermal Response

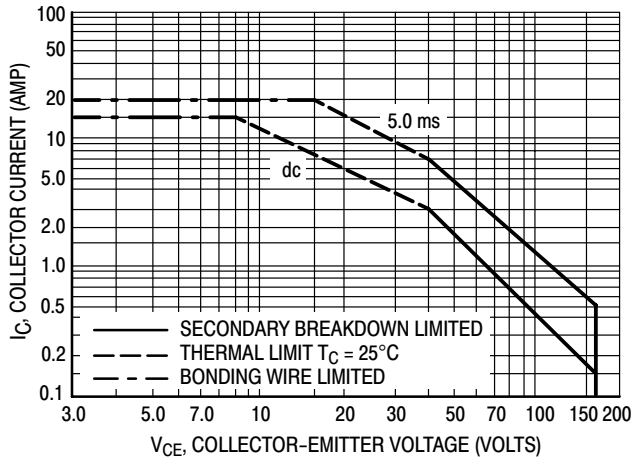

Figure 10. Maximum Forward Bias Safe Operating Area

REVERSE BIAS

For inductive loads, high voltage and high current must be sustained simultaneously during turn-off, in most cases, with the base to emitter junction reverse biased. Under these conditions the collector voltage must be held to a safe level at or below a specific value of collector current. This can be accomplished by several means such as active clamping, RC snubbing, load line shaping, etc. The safe level for these devices is specified as Reverse Bias Safe Operating Area and represents the voltage-current conditions during reverse biased turn-off. This rating is verified under clamped conditions so that the device is never subjected to an avalanche mode. Figure 11 gives RBSOA characteristics.

There are two limitations on the power handling ability of a transistor: average junction temperature and second breakdown. Safe operating area curves indicate $I_C - V_{CE}$ limits of the transistor that must be observed for reliable operation; i.e., the transistor must not be subjected to greater dissipation than the curves indicate.

The data of Figure 10 is based on $T_C = 25^\circ\text{C}$; $T_{J(pk)}$ is variable depending on power level. Second breakdown pulse limits are valid for duty cycles to 10% but must be derated when $T_C \geq 25^\circ\text{C}$. Second breakdown limitations do not derate the same as thermal limitations. Allowable current at the voltages shown on Figure 10 may be found at any case temperature by using the appropriate curve on Figure 9.

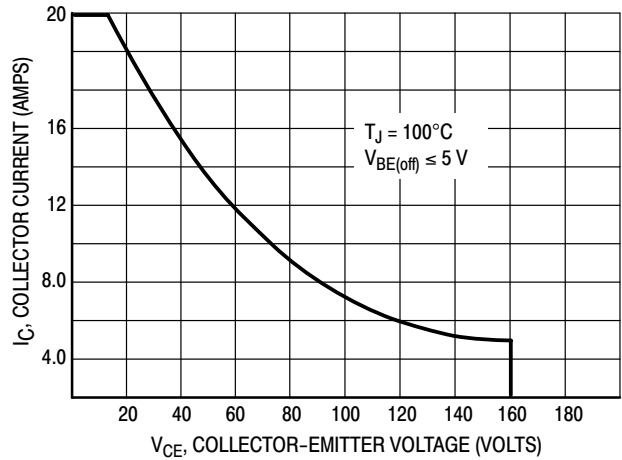
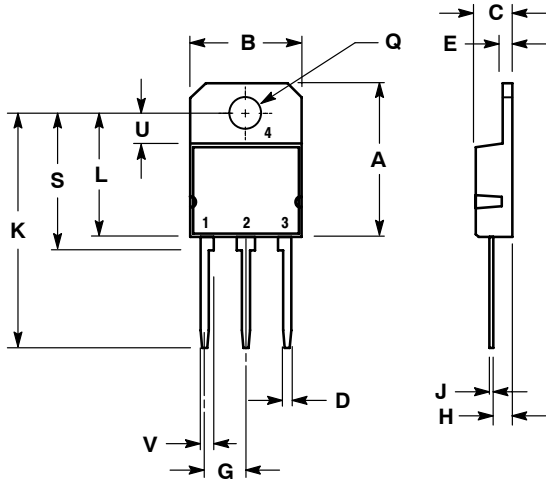

Figure 11. Maximum Reverse Bias Safe Operating Area

MJE4343 MJE4353

PACKAGE DIMENSIONS

CASE 340D-02 ISSUE E



- NOTES:
 1. DIMENSIONING AND TOLERANCING PER ANSI Y14.5M, 1982.
 2. CONTROLLING DIMENSION: MILLIMETER.

DIM	MILLIMETERS		INCHES	
	MIN	MAX	MIN	MAX
A	---	20.35	---	0.801
B	14.70	15.20	0.579	0.598
C	4.70	4.90	0.185	0.193
D	1.10	1.30	0.043	0.051
E	1.17	1.37	0.046	0.054
G	5.40	5.55	0.213	0.219
H	2.00	3.00	0.079	0.118
J	0.50	0.78	0.020	0.031
K	31.00 REF		1.220 REF	
L	---	16.20	---	0.638
Q	4.00	4.10	0.158	0.161
S	17.80	18.20	0.701	0.717
U	4.00 REF		0.157 REF	
V	1.75 REF		0.069	

- STYLE 1:
 PIN 1. BASE
 2. COLLECTOR
 3. EMITTER
 4. COLLECTOR

Notes

ON Semiconductor and  are registered trademarks of Semiconductor Components Industries, LLC (SCILLC). SCILLC reserves the right to make changes without further notice to any products herein. SCILLC makes no warranty, representation or guarantee regarding the suitability of its products for any particular purpose, nor does SCILLC assume any liability arising out of the application or use of any product or circuit, and specifically disclaims any and all liability, including without limitation special, consequential or incidental damages. "Typical" parameters which may be provided in SCILLC data sheets and/or specifications can and do vary in different applications and actual performance may vary over time. All operating parameters, including "Typicals" must be validated for each customer application by customer's technical experts. SCILLC does not convey any license under its patent rights nor the rights of others. SCILLC products are not designed, intended, or authorized for use as components in systems intended for surgical implant into the body, or other applications intended to support or sustain life, or for any other application in which the failure of the SCILLC product could create a situation where personal injury or death may occur. Should Buyer purchase or use SCILLC products for any such unintended or unauthorized application, Buyer shall indemnify and hold SCILLC and its officers, employees, subsidiaries, affiliates, and distributors harmless against all claims, costs, damages, and expenses, and reasonable attorney fees arising out of, directly or indirectly, any claim of personal injury or death associated with such unintended or unauthorized use, even if such claim alleges that SCILLC was negligent regarding the design or manufacture of the part. SCILLC is an Equal Opportunity/Affirmative Action Employer. This literature is subject to all applicable copyright laws and is not for resale in any manner.

PUBLICATION ORDERING INFORMATION

LITERATURE FULFILLMENT:

Literature Distribution Center for ON Semiconductor
P.O. Box 61312, Phoenix, Arizona 85082-1312 USA
Phone: 480-829-7710 or 800-344-3860 Toll Free USA/Canada
Fax: 480-829-7709 or 800-344-3867 Toll Free USA/Canada
Email: orderlit@onsemi.com

N. American Technical Support: 800-282-9855 Toll Free
USA/Canada

Japan: ON Semiconductor, Japan Customer Focus Center
2-9-1 Kamimeguro, Meguro-ku, Tokyo, Japan 153-0051
Phone: 81-3-5773-3850

ON Semiconductor Website: <http://onsemi.com>

Order Literature: <http://www.onsemi.com/litorder>

For additional information, please contact your
local Sales Representative.