

PREPARED BY: <i>O. Kitagawa</i>	DATE: <i>Nov/10/98</i>	SHARP	SPEC.No. DG989001
APPROVED BY: <i>T. Kotani</i>	DATE: <i>Nov/31/98</i>		ELECTRONIC COMPONENTS GROUP SHARP CORPORATION
SPECIFICATION			PAGE 15 pages
			REPRESENTATIVE DIVISION: Opto-Electronic Devices Division

DEVICE SPECIFICATION FOR

Light Emitting Diode

MODEL No.

LT1ZR95A series

1. These specification sheets include materials protected under the copyright of Sharp Corporation ("Sharp"). Please do not reproduce or cause anyone to reproduce them without Sharp's consent.
2. When using this product, please observe the absolute maximum ratings and the instructions for use outlined in these specification sheets, as well as the precautions mentioned below. Sharp assumes no responsibility for any damage resulting from use of the product which does not comply with the absolute maximum ratings and the instructions included in these specification sheets, and the precautions mentioned below.

(Precautions)

 - (1) This products is designed for use in the following application areas;

* OA equipment	* Audio visual equipment	* Home appliance
* Telecommunication equipment (Terminal)	* Measuring equipment	
* Tooling machines	* Computers	

If the use of the product in the above application areas is for equipment listed in paragraphs (2) or (3), please be sure to observe the precautions given in those respective paragraphs.
 - (2) Appropriate measures, such as fail-safe design and redundant design considering the safety design of the overall system and equipment, should be taken to ensure reliability and safety when this product is used for equipment which demands high reliability and safety in function and precision, such as ;

* Transportation control and safety equipment (aircraft, train, automobile etc.)
* Traffic signals * Gas leakage sensor breakers * Rescue and security equipment
* Other safety equipment
 - (3) Please do not use this product for equipment which require extremely high reliability and safety in function and precision, such as ;

* Space equipment * Telecommunication equipment (for trunk lines)
* Nuclear power control equipment * Medical equipment
 - (4) Please contact and consult with a Sharp sales representative if there are any questions regarding interpretation of the above three paragraphs.
3. Please contact and consult with a Sharp sales representative for any questions about this product.

CUSTOMER'S APPROVAL

DATE: _____

BY: _____

DATE: *Nov 14, 1998*

PRESENTED BY: *M. Katoh*

M. Katoh,
Department General Manager of
Engineering Dept., III
Opto-Electronic Devices Division
Electronic Components Group
SHARP CORPORATION

LT1ZR95A series Specification

1. Application

This specification applies to the light emitting diode device Model No. LT1ZR95A series.
(AlGaInP chip LED device)

Model No.	Radiation color	Dominant wavelength TYP.
LT1ZG95A	Green	560nm
LT1ZE95A	Yellow-green	570nm
LT1ZV95A	Yellow	588nm
LT1ZS95A	Sunset orange	605nm
LT1ZJ95A	Orange	618nm
LT1ZR95A	Red	635nm

- 2. Outline dimensions and terminal connections Refer to the attached sheet Page 2.
- 3. Ratings and characteristics Refer to the attached sheet Page 3.
 - 3-1. Absolute maximum ratings
 - 3-2. Electro characteristics
 - 3-3. Optical characteristics
 - 3-4. Luminous intensity rank
- 4. Characteristics Diagrams Refer to the attached sheet Page 4~7.
- 5. Reliability Refer to the attached sheet Page 8.
 - 5-1. Test items and test conditions
 - 5-2. Failure judgement criteria
- 6. Incoming inspection Refer to the attached sheet Page 9.
 - 6-1. Inspection method
 - 6-2. Description of inspection and criteria
- 7. Taping specification Refer to the attached sheet Page 10~13.
 - 7-1. Taping
 - 7-2. Label
 - 7-3. Dampproof package
- 8. Soldering Refer to the attached sheet Page 14.
 - 8-1. Reflow soldering
 - 8-2. Manual soldering
 - 8-3. Dip soldering method
- 9. Precautions for use Refer to the attached sheet Page 15.
 - 9-1. Precautions matters for designing circuit
 - 9-2. Cleaning method
- 10. Environment Refer to the attached sheet Page 15.
 - 10-1. Ozonosphere destructive chemicals.
 - 10-2. Bromic non-burning materials

SHARP

2. Outline dimensions and terminal connections

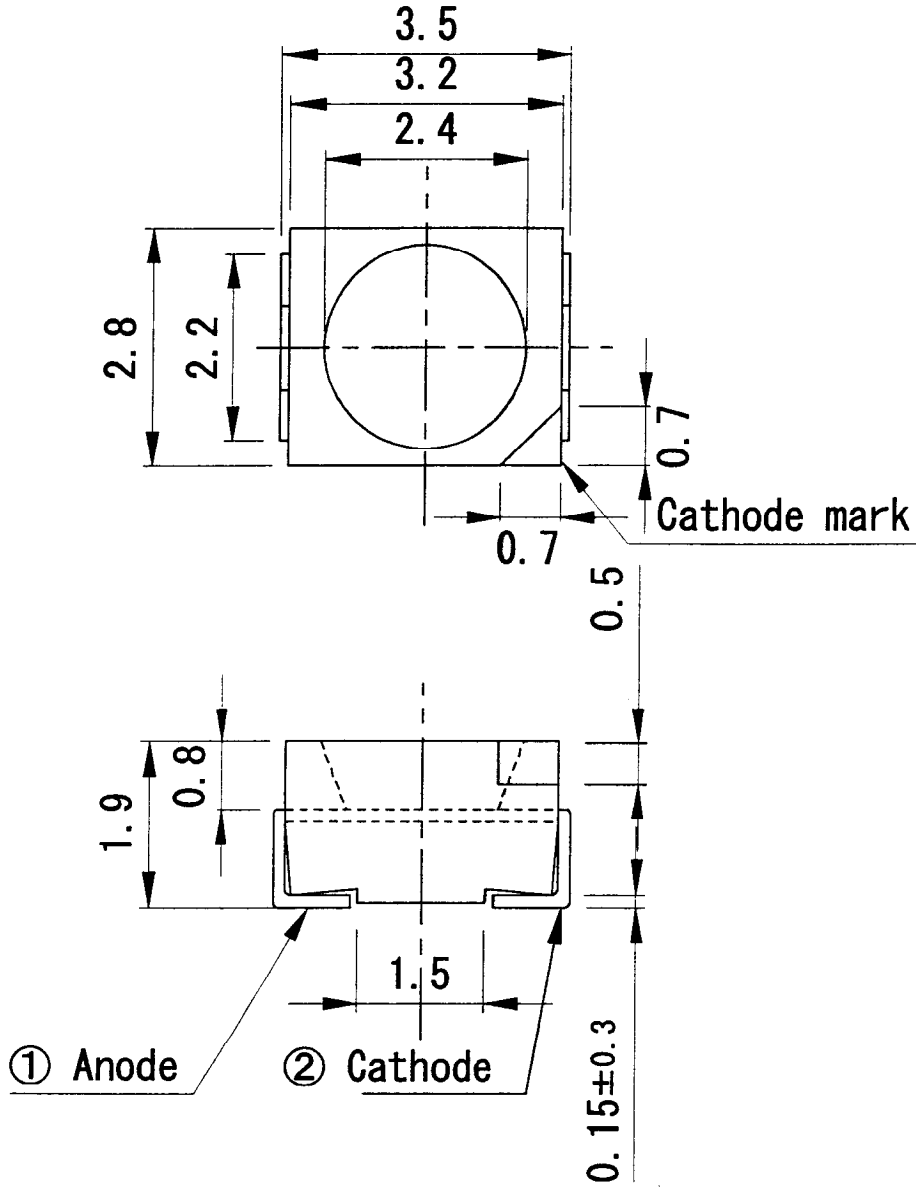

Note.

1. It is not include the flash in this dimension.
2. Pin Connection ① Anode ② Cathode
3. Unspecified tolerance to be ±0.2

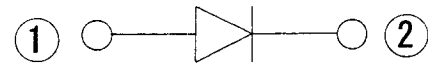

Unit	Scale	Applicable Model	Drawing No.
mm	Free	LT1ZR95A series	51009001

SHARP

3. Ratings and characteristics

3-1. Absolute maximum ratings

(Ta=25°C)

Parameter	Symbol	Rating	Unit
Power dissipation	P	130	mW
Continuous forward current	I _F	50	mA
Peak forward current (Note 1)	I _{FM}	100	mA
Derating factor	DC	0.67	mA/°C
	Pulse	1.33	mA/°C
Reverse voltage	V _R	5	V
Operating temperature	Topr	-55 to +110	°C
Storage temperature	Tstg	-55 to +110	°C
Soldering temperature (Note 2)	Tsol	295	°C

(Note1) Duty ratio=1/10, Pulse width=0.1ms

(Note2) Manual soldering Max.3second

3-2. Electro characteristics

(Ta=25°C)

Parameter	Symbol	Conditions	MIN.	TYP.	MAX.	Unit
Forward voltage	V _F	I _F =20mA	-	(2.2)	2.6	V
Reverse current	I _R	V _R =4V	-	-	100	μA
Terminal capacitance	C _t	V=0V, f=1MHz	-	60	-	pF

3-3. Optical characteristics

(Ta=25°C)

Model No.	Condition	Luminous intensity *3 I _v (mcd)TYP.	luminous intensity rank				Peak-wavelength λ p(nm)TYP.	dominant wavelength λ d(nm) TYP.
			b	a	A	B		
LT1ZG95A	I _F =20mA	15	b	a	A	B	560	560
LT1ZE95A		45	C	D	E	F	570	570
LT1ZV95A		170	G	H	I	J	590	588
LT1ZS95A		290	G	H	I	J	609	605
LT1ZJ95A		200	G	H	I	J	623	618
LT1ZR95A		90	D	E	F	G	644	635

(Note3) Measured by SHARP EG&G MODEL550 (Radiometer/Photometersystem)

3-4. Luminous intensity rank

(Ta=25°C)

Rank : Luminous intensity	Rank : Luminous intensity	Unit	Condition	
b : 4.8 ~ 9.2	E : 43 ~ 84	mcd	I _F =20mA	Tolerance: ±15%
a : 6.9 ~ 13.2	F : 62 ~ 121			
A : 10 ~ 19	G : 89 ~ 174			
B : 14 ~ 28	H : 128 ~ 250			
C : 21 ~ 40	I : 185 ~ 360			
D : 30 ~ 58	J : 266 ~ 518			



4 Characteristics Diagrams

LT1ZG95A

LT1ZE95A

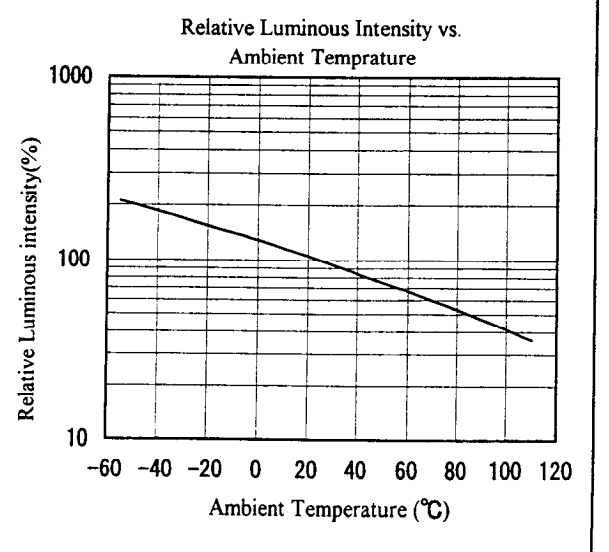
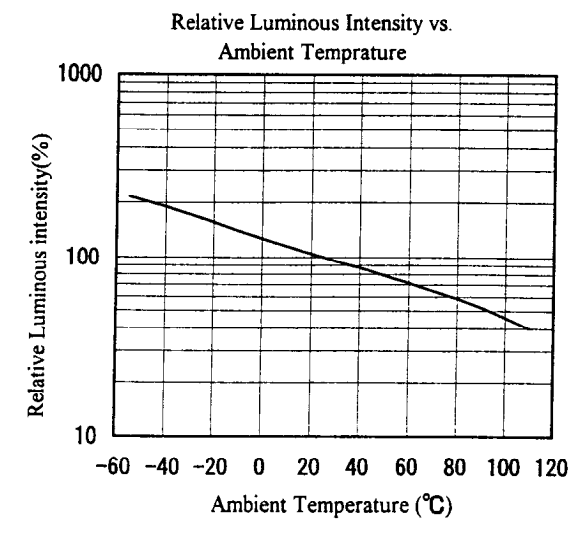
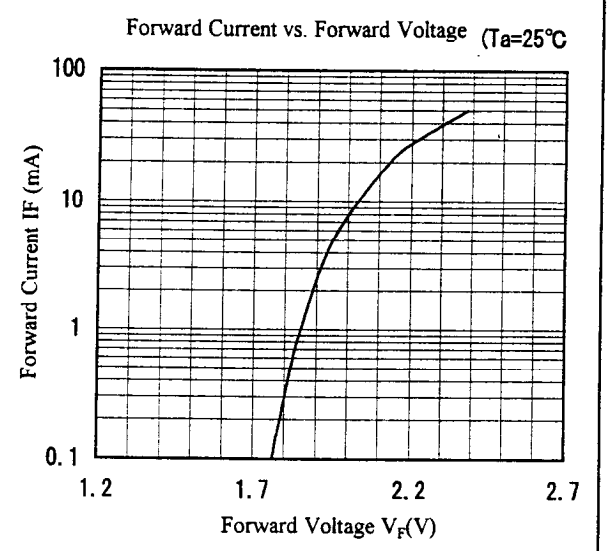
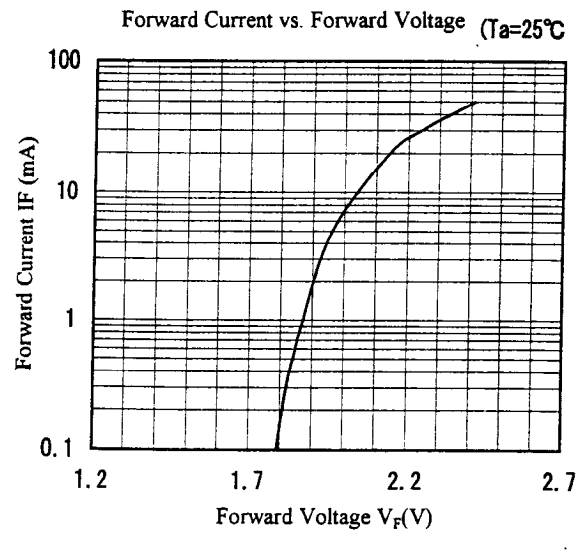
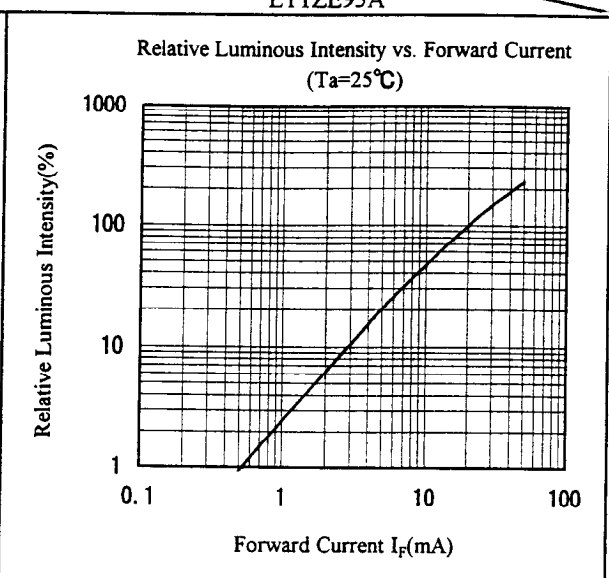
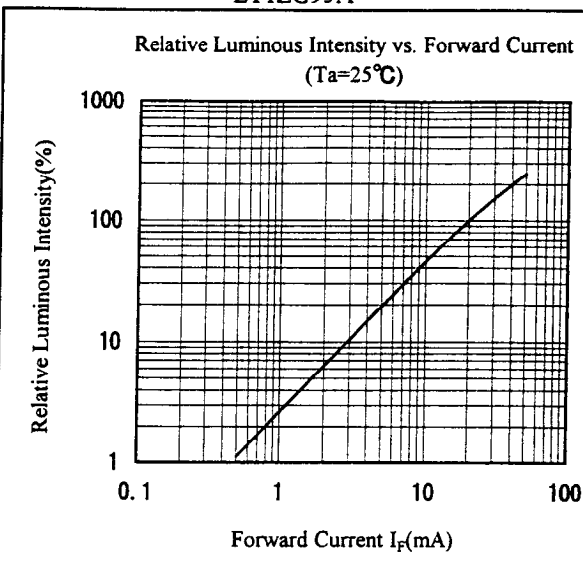

(Note) Above characteristic data are typical data and not a guaranteed data.

ZG/ZE

SHARP

4 Characteristics Diagrams

LT1ZV95A

LT1ZS95A

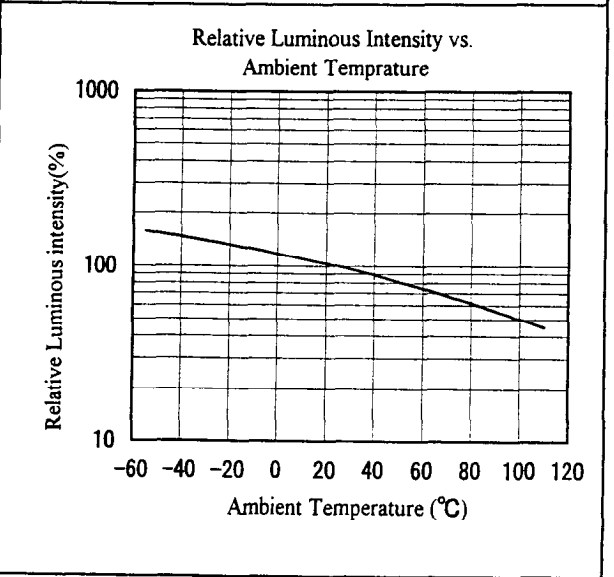
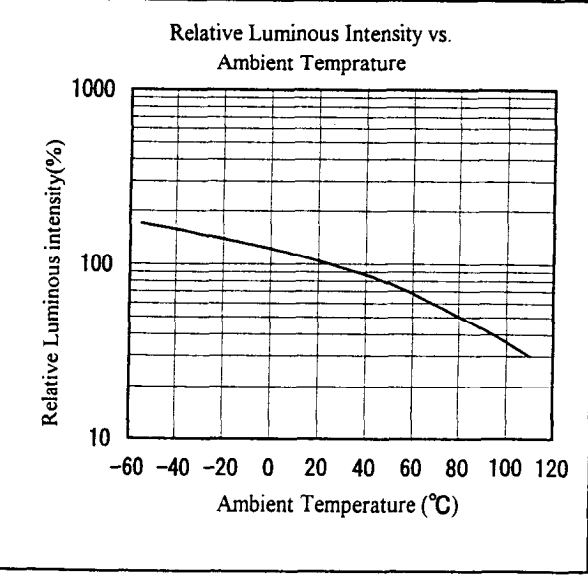
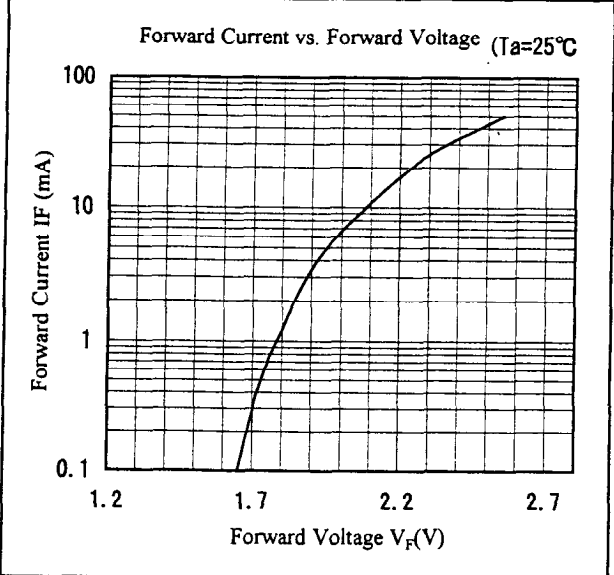
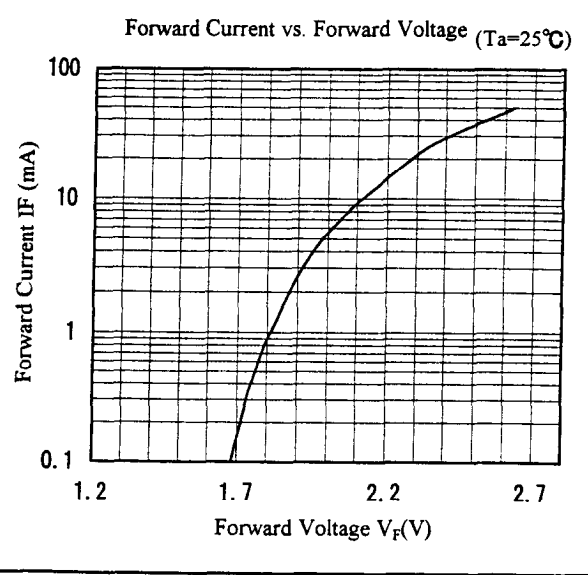
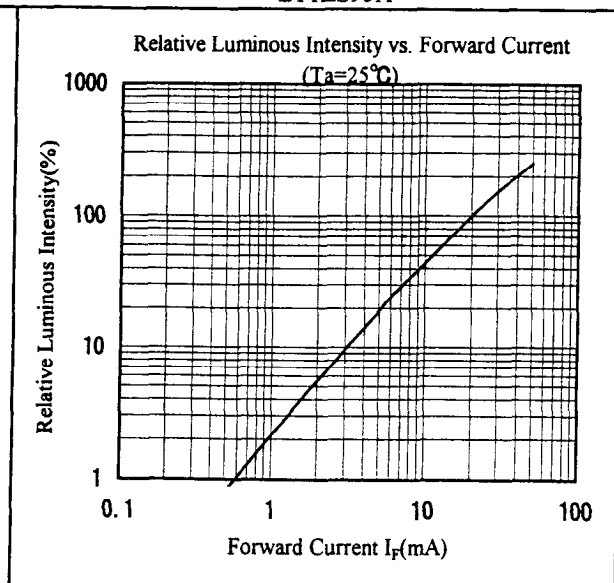
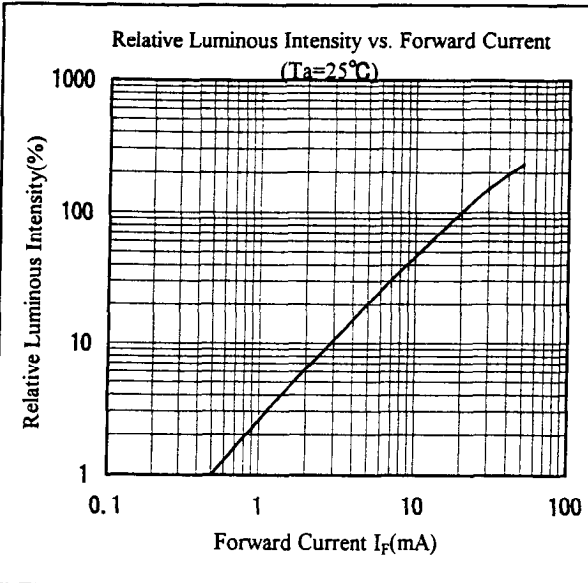

(Note) Above characteristic data are typical data and not a guaranteed data.

ZV/ZS

SHARP

4 Characteristics Diagrams

LT1ZJ95A

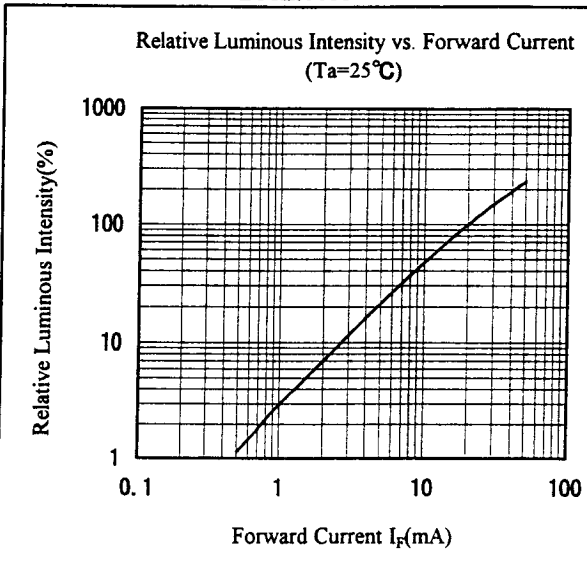

LT1ZR95A

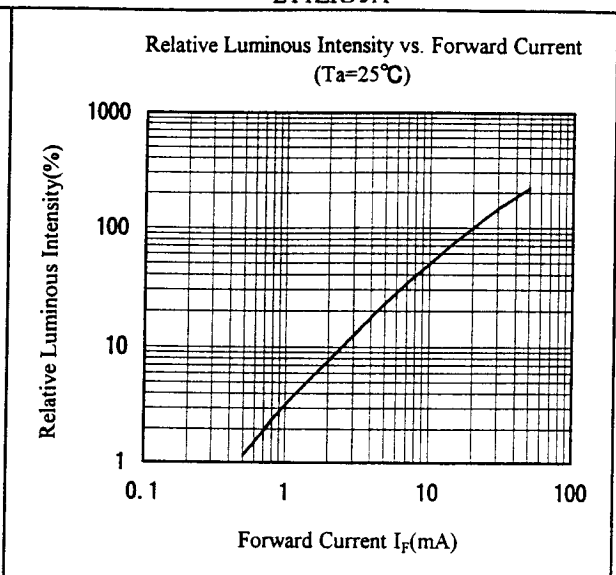

Forward Current vs. Forward Voltage ($T_a=25^\circ\text{C}$)

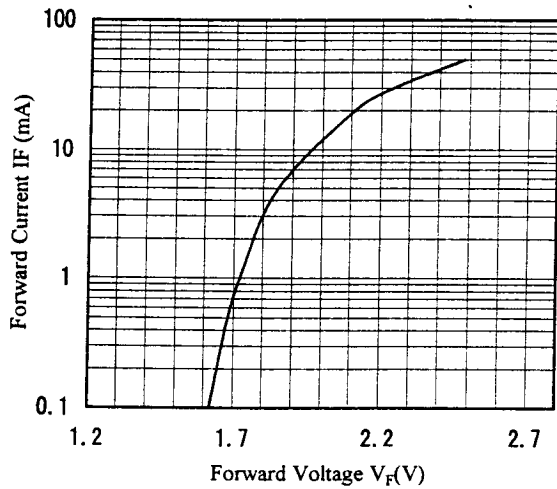

Forward Current vs. Forward Voltage ($T_a=25^\circ\text{C}$)

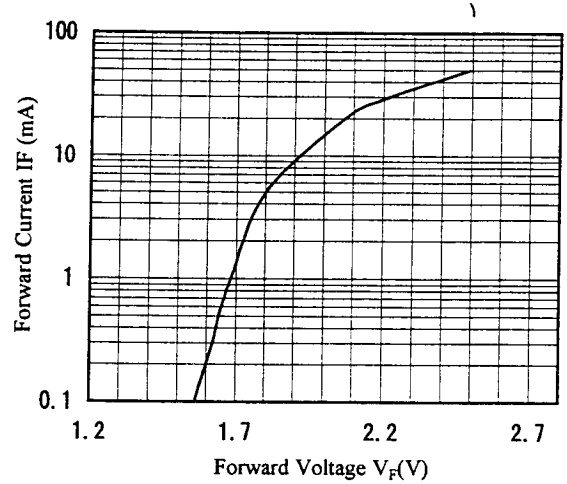

Relative Luminous Intensity vs. Ambient Temperature

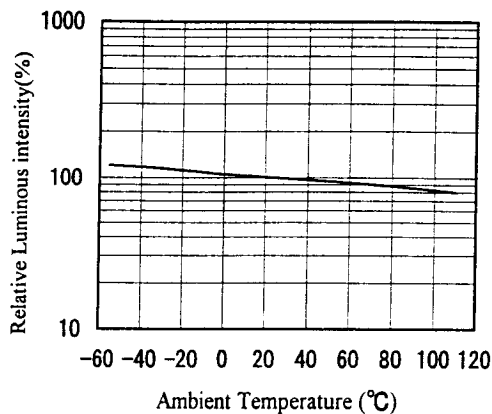

Relative Luminous Intensity vs. Ambient Temperature

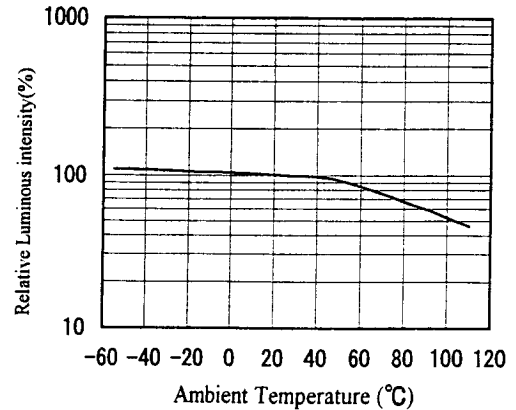

(Note) Above characteristic data are typical data and not a guaranteed data.

ZJ/ZR

REFERENCE

SHARP

4 Characteristics Diagrams

LT1ZR95A series

Peak Forward Current Derating Curve

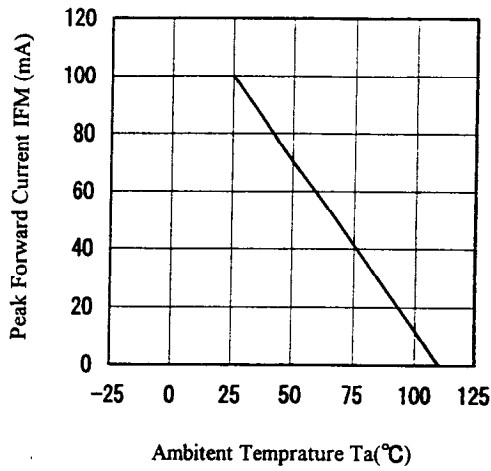

Forward Current Derating Curve

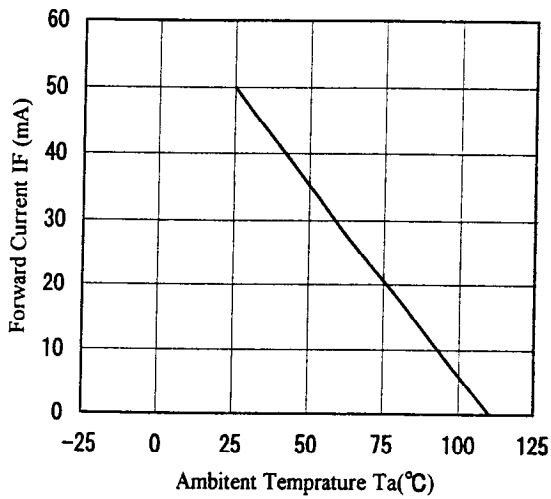

Peak Forward Current vs. Duty Ratio(Ta=25°C)

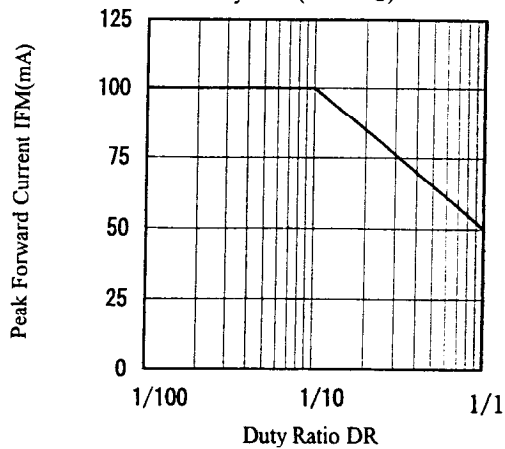

(Note) Above characteristic data are typical data and not a guaranteed data.

5. Reliability

The reliability of products shall be satisfied with items listed below.

5-1. Test items and test conditions(in accordance with JIS 7021)

Confidence level: 90%

Test items	Test conditions	Samples (n) Defective (C)	LTPD (%)
temperature cycling	-55°C(30min)~+110°C(30min),100cy	n=22, C=0	10
High temp. and high humidity storage	Ta=+85°C, 85%RH, t=1000h	n=22, C=0	10
High temperature storage	Ta=(Tstg_maximum ratings),t=1000h	n=22, C=0	10
Low temperature storage	Ta=(Tstg_minimun ratings),t=1000h	n=22, C=0	10
Operating test	Ta=25°C, I _F =(I _F _maximum ratings),t=1000h	n=22, C=0	10
Mechanical shock	15 000m/s ² , 0.5ms, 3times / ±X,±Y,±Z direction	n=11, C=0	20
Variable frequency vibration	200m/s ² , 100~2 000~100Hz/sweepfor 20min., 4times/X,Y,Z direction	n=11, C=0	20
Soldering heat	Refer to the attached sheet, Page 14/15 1 time	n=11, C=0	20

5-2. Failure judgement criteria (Note1)

Parameter	Symbol	Failure judgement criteria (Note2)
Forward voltage	V _F	V _F > U.S.L. × 1.2
Reverse current	I _R	I _R > U.S.L. × 2.0
Luminous intensity	I _v	I _v > The first stage value × 2.0 or The first stage value × 0.5 > I _v

(Note1)Measuring condition is in accordance with specification.

(Note2)U.S.L. is shown by Upper Specification Limit.

SHARP

6. Incoming inspection

6-1. Inspection method

A single sampling plan, normal inspection level II based on ISO 2859-1 shall be adopted.

6-2. Description of inspection and criteria

No.	Inspection items	Criteria	Defect	AQL
1	Electro-optical characteristics	Not radiation	Major defect	0.1%
2	Radiation color	Not correct		
3	Taping	Product inserted in reverse direction		
4	Tape peeling	Continuous separation of cover tape causing the product to fall out		
5	Label	Model number is not printed, or misprinted		
6	Mix	Another model is mixing		
7	Quantity wanting	Quantity in package is wanting		
8	Luminous intensity	Not conforming to the specification	Minor defect	0.4%
9	Electro-optical characteristics	Not conforming to the specification		
10	Outline dimensions	Not conforming to the specification		
11	Label	Quantity or Lot No. is misprinted		
12	Dust and flaw	Effect to the specification		
13	Resin flash	0.3mm or greater from the product		

*1 Judgement area : The plated area of the product bottom and side

SHARP

7. Taping
 7-1 Taping
 7-1-1. Shape and dimension of tape(TYP.)

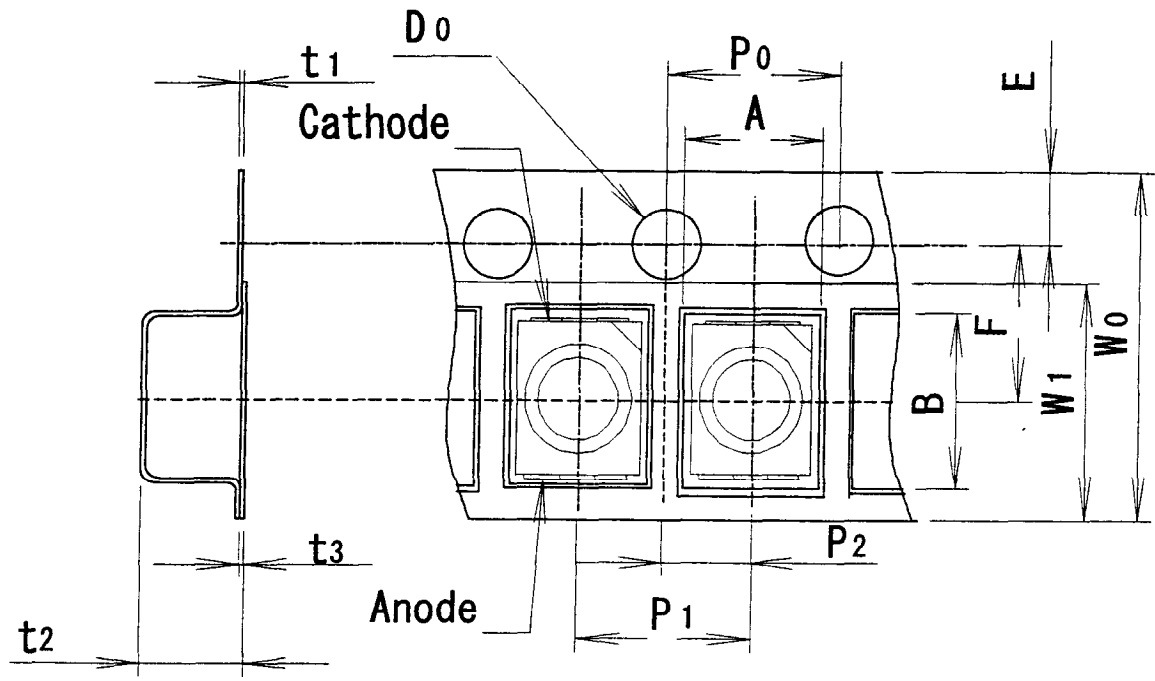

Parameter	Symbol	Dimension [mm](TYP.)	Remarks	
Concave square hole for part insertion	Vertical	A	3.2	Dimension excludes corner R at inside bottom
	Horizontal	B	3.8	
	Pitch	P_1	4.0	
Round sprocket hole	Diameter	D_0	1.55	
	Pitch	P_0	4.0	Accumulated error $\pm 0.5\text{mm}/10$ pitch
	Position	E	1.75	Distance between tape edge and hole center
Center to center dimension	Vert. dire	P_2	2.0	Center line of the concave square hole and round sprocket hole
	Hori. dire	F	3.5	
Cover tape	Width	W_1	5.5	
	Thickness	t_3	0.1	
Carrier tape	Width	W_0	8.0	
	Thickness	t_1	0.3	
Thickness of the entire unit	t_2	2.3	With cover tape and carrier tape combined	

※ Material : Carrier tape...PS, Cover tape...Polyester



7-1-2.Shape and dimension of reel(TYP.)

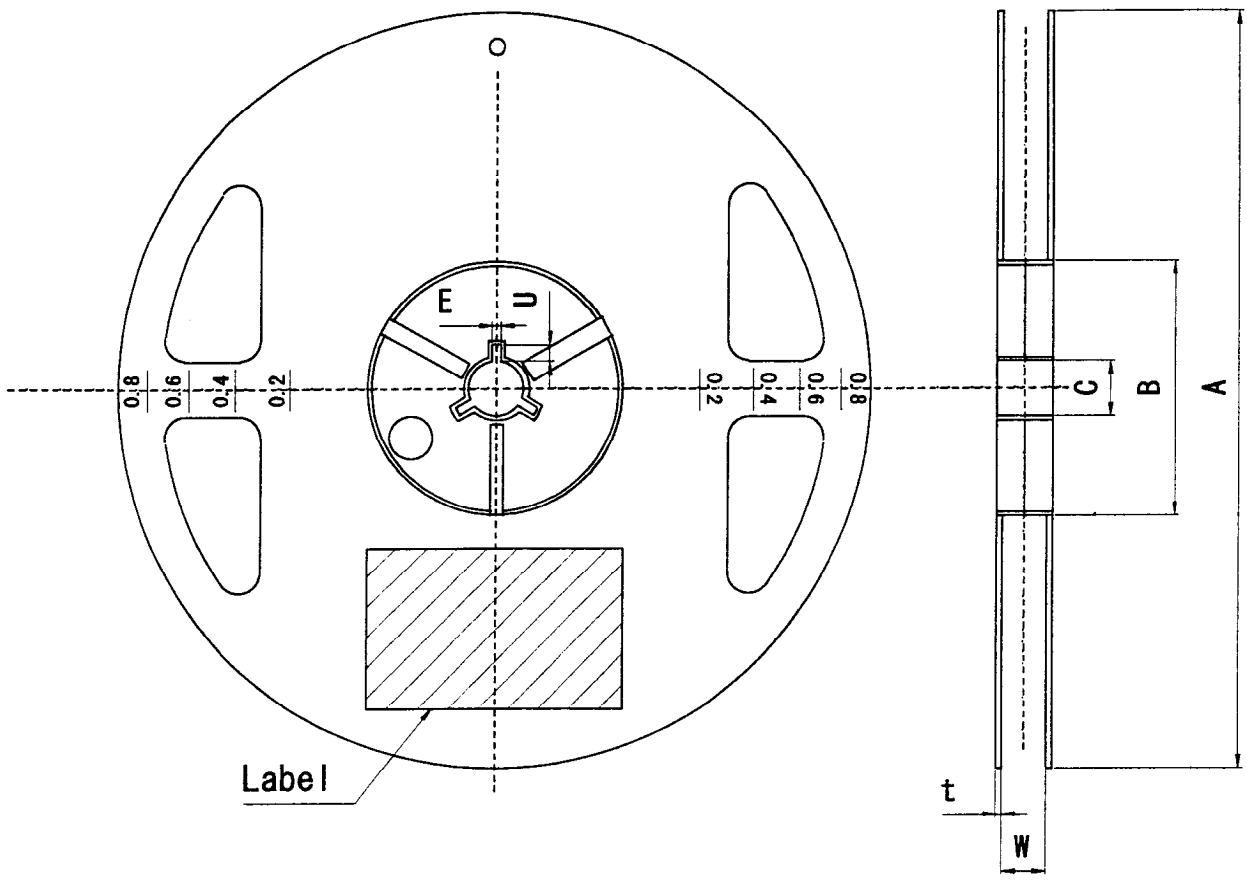

Parameter		Symbol	Dimension [mm](TYP.)	Remarks
Flange	Diameter	A	φ 178	
	Thickness	t	1.5	
	Inner space direction	W	10	Dimension of shaft core
Hub	External diameter	B	φ 60	
	Spindle hole diameter	C	φ 13	
	Key slit	Width	E	2.0
Depth		U	4.5	
Notation for part name etc.		Labeling on one side of flange.(part name,quantity,lot No.)		

※ Material : Reel...Polystyrene

SHARP

7-1-3. Taping specification

(1) Lead tape:

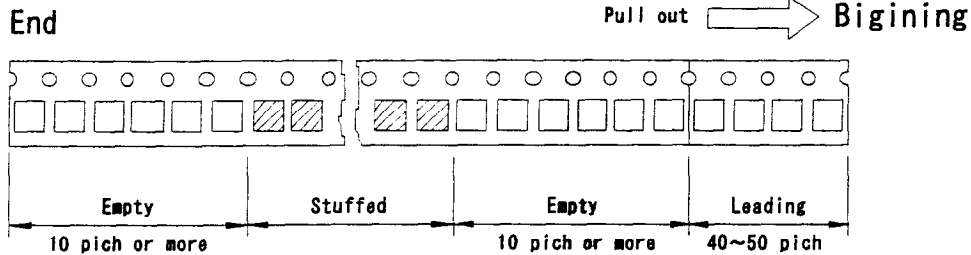

(2) Cover tape strength against peeling: $F=0.1\sim0.8N$ ($\theta = 10^\circ$ or less)

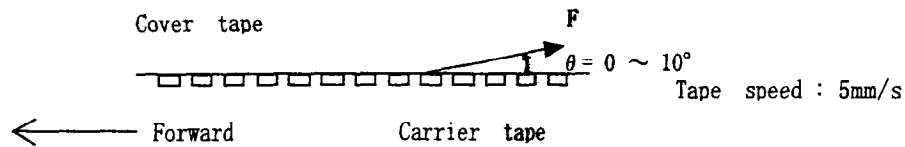

(3) Tape strength against bending:

The radius of bending circle should be 30mm or more.

If it is less than 30mm, the cover may peel.

(4) Jointing of tape: There should not be joint of cover tape or carrier tape.

(5) Quantity per reel: Average 2,000pcs. per reel

(6) Product weight: Approx. 0.03 g

- (7) Others:
- ① Apparent defect of product should not be packed and product should not upset.
 - ② There should not be missing above continuous three products.
 - ③ Products should be easily taken out.
 - ④ Products should not be attached to the cover tape at peeling.

7-2. Label for reel

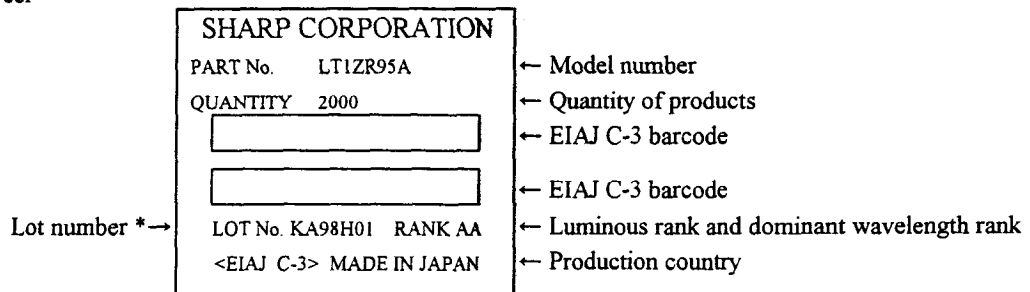

* :Lot number indication

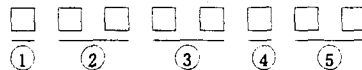

- ① Production plant code(to be indicated alphabetically)
- ② Production lot(single or double figures)
- ③ Year of production(the last two figures of the year)
- ④ Month of production
(to be indicated alphabetically with January corresponding to A)
- ⑤ Date of production(01 ~ 31)

SHARP**7-3. Dampproof package**

In order to avoid the absorption of humidity in transport and storage, the devices are packed in aluminum sleeve.

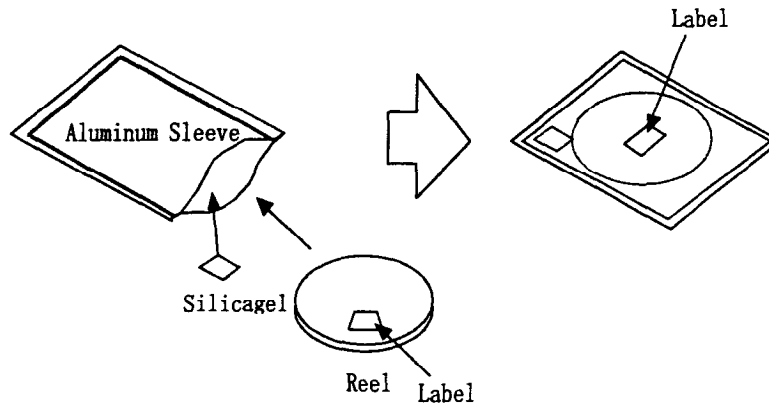
**7-3-1. Storage conditions**

Temperature : 5 to 30°C Humidity : less than 60%RH

7-3-2. Treatment after opening

(1) Please make a soldering within 2 days after opening under following condition;

Temperature : 5 to 30°C Humidity : less than 60%RH

(2) In case the devices are not used for a long time after opening, the storage in dry box is recommendable.

Or it is better to repack the devices with a desiccative by the sealer and put them in the some storage conditions as 7-3-1. Then they should be used within 2 days.

(3) Please make a soldering after a following baking treatment if unused term should be over the conditions of (2)

Recommendable conditions:

① in taping

Temperature: 60°C to 65°C, Time: 36 to 48 hours

② in individual (on PWB or metallic tray)

Temperature: 100°C, Time: 2 to 3 hours

SHARP**8. Soldering****8-1. Reflow soldering**

(1) It is not recommended to exceed the soldering temperature and time shown below.

Caused by substrate bend or the other mechanical stress during reflow soldering may happen gold wire disconnection etc. Therefore please check and study your solder reflow machine's best condition.

(2) Reflow soldering temperature profile to be done under the following condition.
to be done under the following condition.

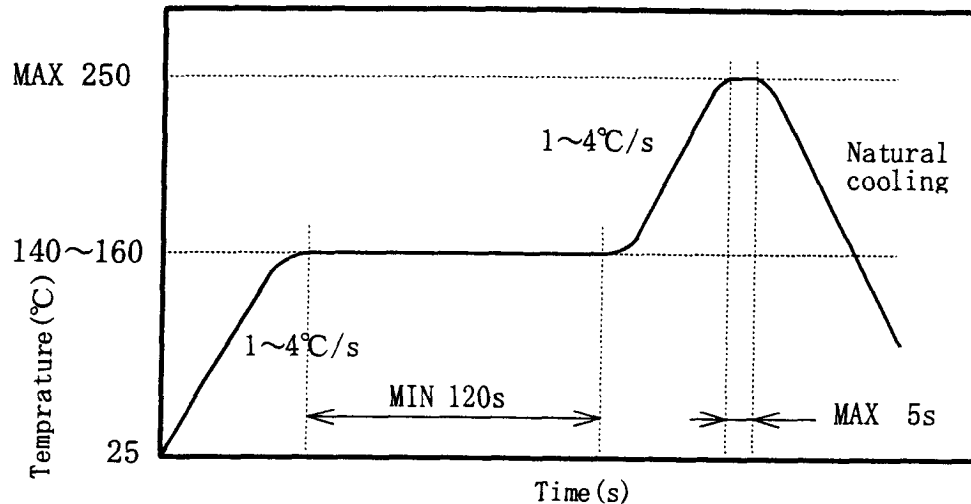

Recommendable Thermal Model

(4) Recommendable Metal Mask pattern for screen print

Recommend 0.2mm to 0.3mm thickness metal mask for screen print. Caused by solder reflow condition, solder paste, substrate and the other material etc., may change solderability.

Please check and study actual solderability before usage.

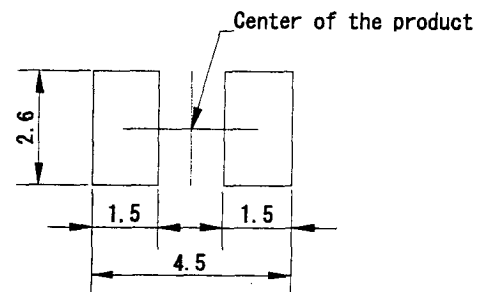

Recommended solder pattern

8-2. Manual soldering

(1) It is recommended to keep the soldering iron temperature at 295°C (soldering iron power consumption 20W) and not to solder more than once or for over 3 seconds.

(2) When using a soldering iron, care must be taken not to damage the package.

(Pay attention not to allow any under stress or heat on package.)

8-3. Dip soldering method

To be done under the following condition.

Pre-heat temp. : 80 to 120 °C

time : 30 to 120 seconds

Soldering temp. : Max. 260°C

time : within 5 seconds

SHARP

9. Precautions for use

9-1. Precautions matters for designing circuit

This product is not designed as electromagnetic and ionized-particle radiation resistant.

9-2. Cleaning method

(1) Solvent cleaning

Recommend conditions: ① Solvent temperature is not more than 45 °C. ② Immersion up to 3 minutes.

(2) Ultrasonic cleaning

The affect on the device from ultrasonic bath, ultrasonic output, duration, board size and device mounting method.

Test the cleaning method under actual conditions and check for abnormalities before actual use.

(3) Solvents

Use only the following types of solvent.

water, alcohol, chlorofluorocarbon-based solvent when cleaning is necessary.

Recommend conditions: R.T. 40KHz, 30W/1, 3 to 5 minutes

10. Environment

10-1. Ozonosphere destructive chemicals.

(1) The device doesn't contain following substance.

(2) The device doesn't have a production line whose process requires following substance.

Restricted part: CFCs,halones,CCl₄,Trichloroethane(Methychloroform)

10-2. Bromic non-burning materials

The device doesn't contain bromic non-burning materials(PBBOs,PBBs)