

**2SC1755,
1756,
1757**

T-33-07

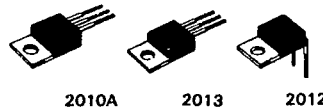

NPN Triple Diffused Planar Silicon Transistors

**TV Chroma Output, Video Output,
Sound Output Applications**

©429D

These 2SC1755,1756,1757 are different only from their packages.

Absolute Maximum Ratings at Ta=25°C		unit
Collector to Base Voltage	V _{CB0}	300 V
Collector to Emitter Voltage	V _{CE0}	300 V
Emitter to Base Voltage	V _{EB0}	7 V
Collector Current	I _C	200 mA
Peak Collector Current	i _{cp}	700 mA
Collector Dissipation	P _C	1.2 W
	P _C Tc=25°C	15 W
Junction Temperature	T _j	150 °C
Storage Temperature	T _{stg}	-40 to +150 °C

Electrical Characteristics at Ta=25°C		min	typ	max	unit
Collector Cutoff Current	I _{CB0} V _{CB} =200V, I _E =0			0.1	uA
Emitter Cutoff Current	I _{EB0} V _{EB} =5V, I _C =0			0.1	uA
DC Current Gain	h _{FE} V _{CE} =10V, I _C =10mA	40*		200*	
Gain Bandwidth Product	f _T V _{CE} =30V, I _C =10mA	50			MHz
Output Capacitance	C _{ob} V _{CB} =50V, f=1MHz			5.3	pF
C-E Saturation Voltage	V _{CE(sat)} I _C =50mA, I _B =5mA			2.0	V

* The 2SC1755,1756, 1757 are classified as follows.

40	C	80	60	D	120	100	E	200
----	---	----	----	---	-----	-----	---	-----

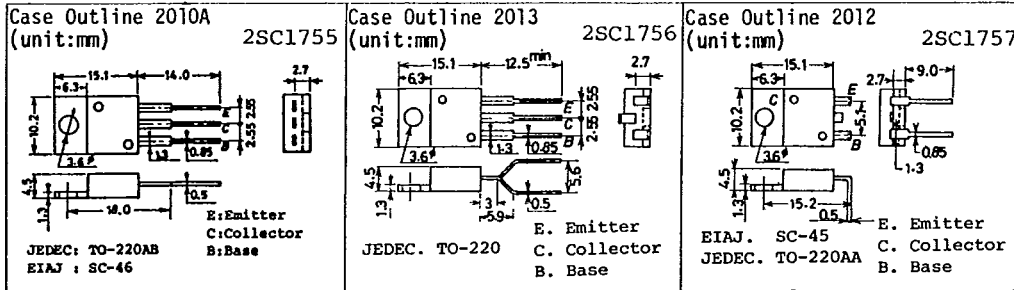

The 2SC1757 is scheduled to be discontinued soon. Use the 2SC1756, instead of the 2SC1757, in new applications where you are planning to use the 2SC1757.

2SC1755, 1756, 1757

(T-33-07

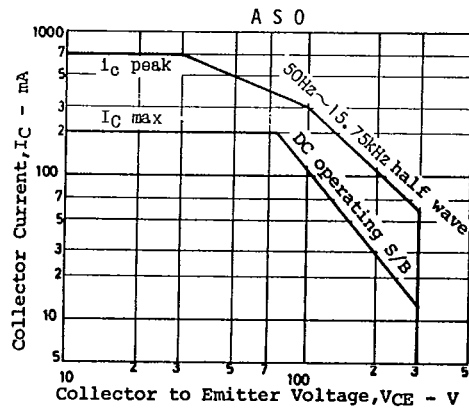
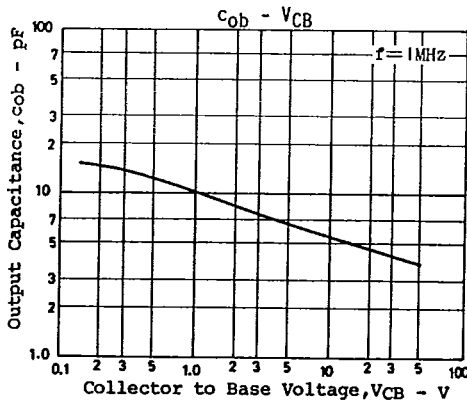
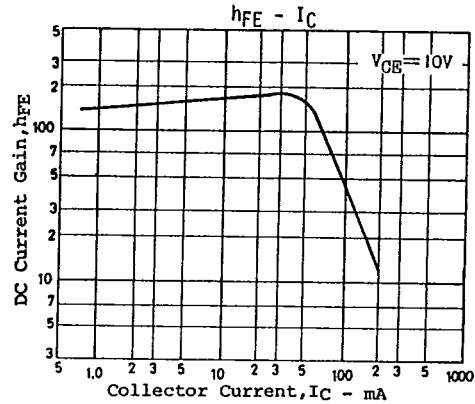
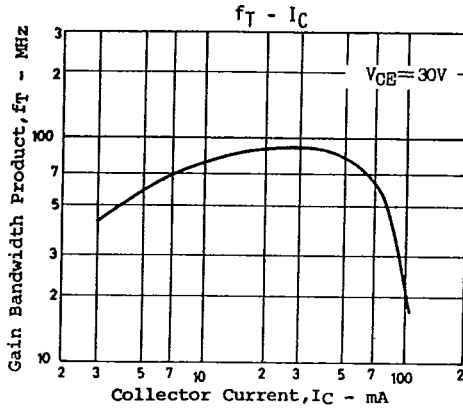
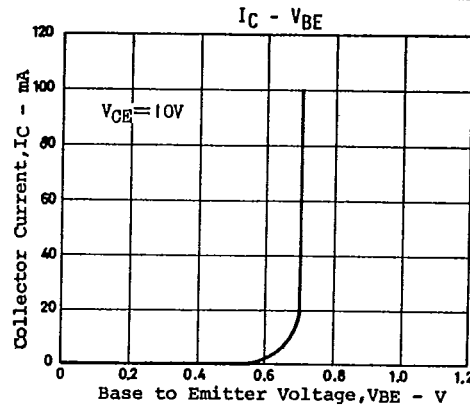
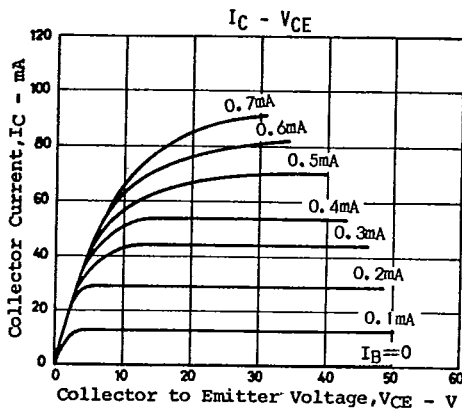

T-91-20

CASE OUTLINES AND ATTACHMENTS

- All of Sanyo Transistor case outlines are illustrated below.
- All dimensions are in mm, and dimensions which are not followed by min. or max. are represented by typical values.
- No marking is indicated.

Case Outline-[2003A]
unit:mm

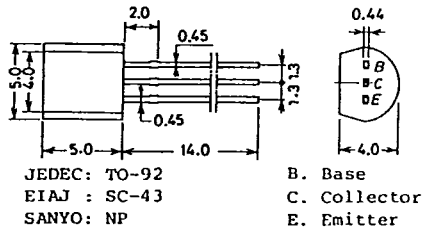

Case Outline-[2009A]
unit:mm

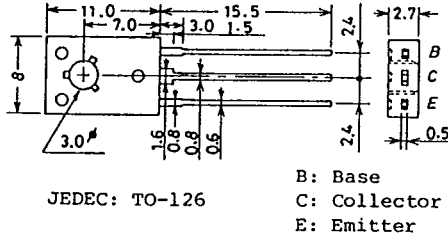

Case Outline-[2004A]
unit:mm

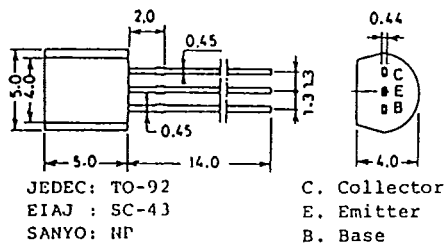

Case Outline-[2010A]
unit:mm

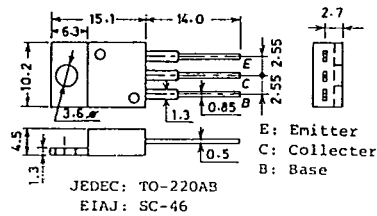

Case Outline-[2005A]
unit:mm

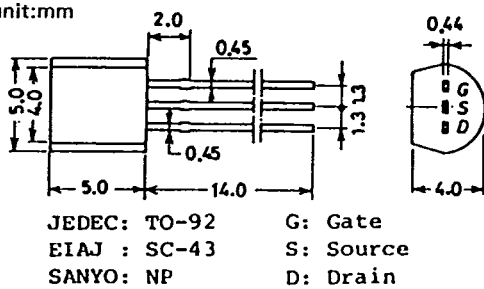

Case Outline-[2012]
unit:mm

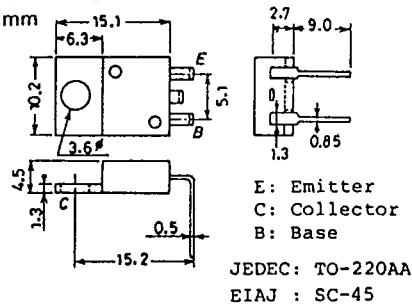

Case Outline-[2006A]
unit:mm

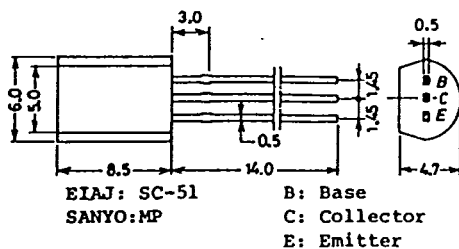

Case Outline-[2013]
unit:mm

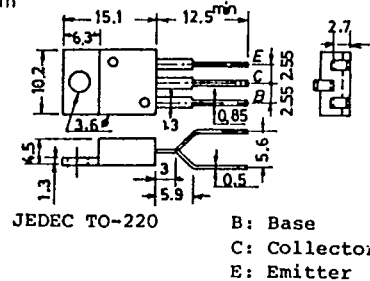

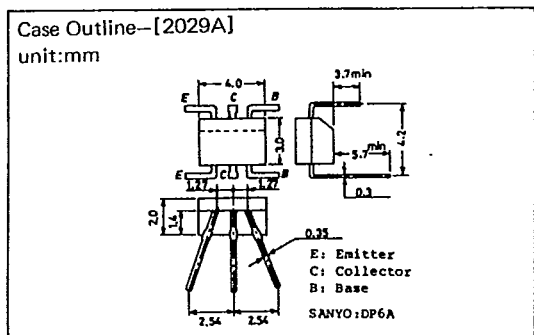
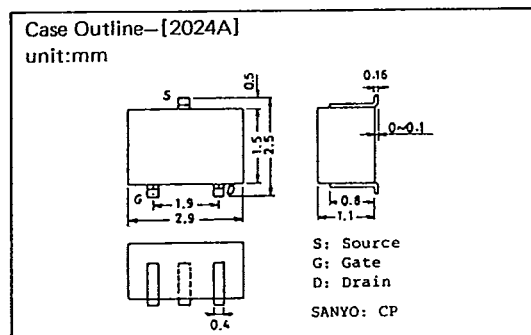
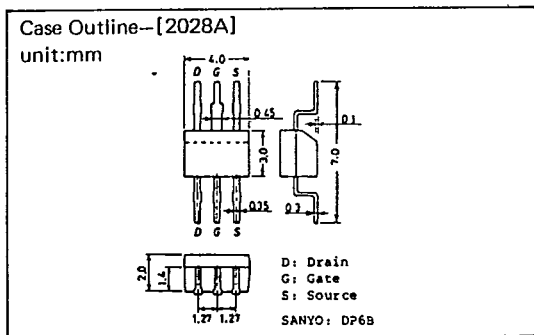
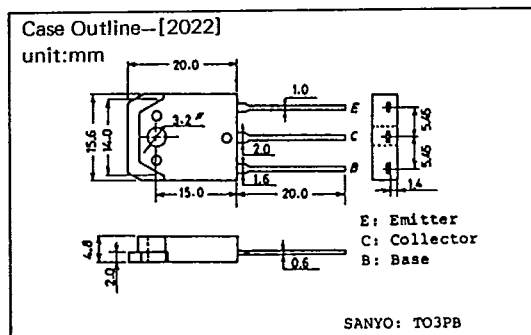
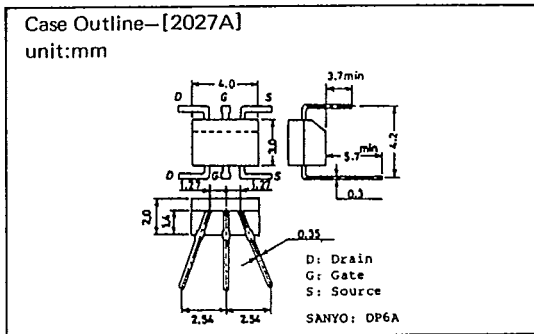
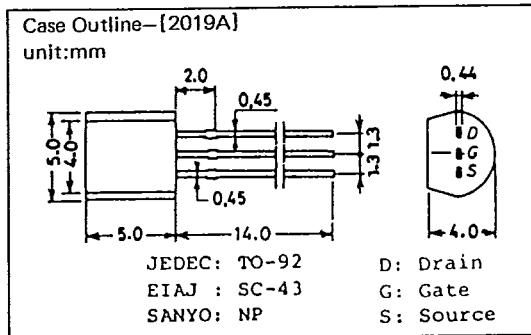
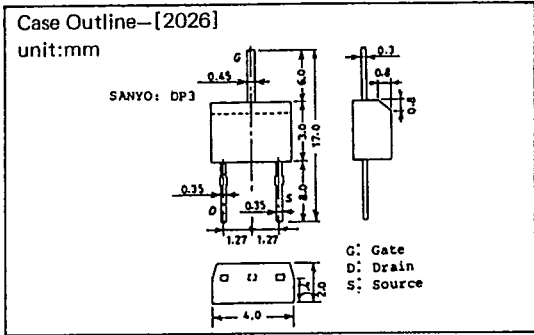
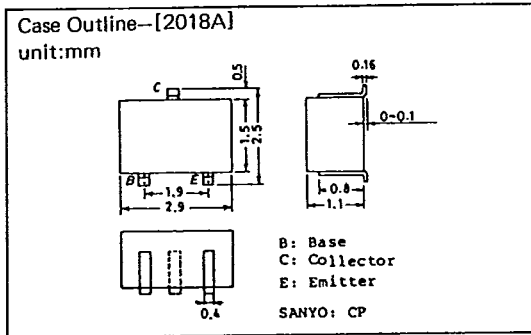
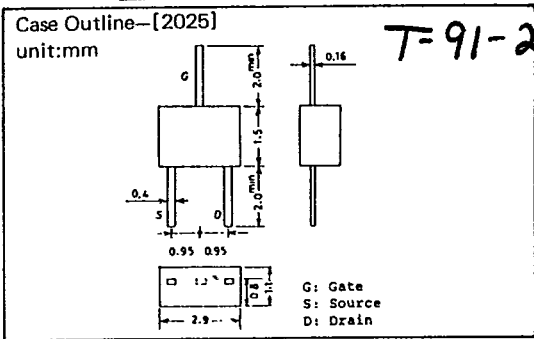
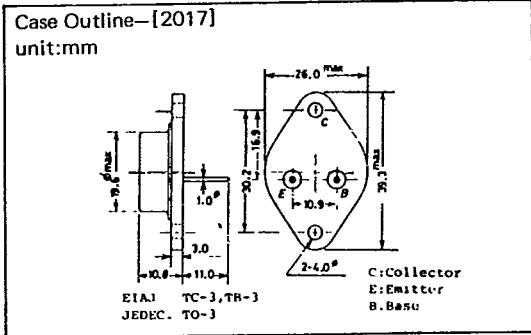

T-91-20

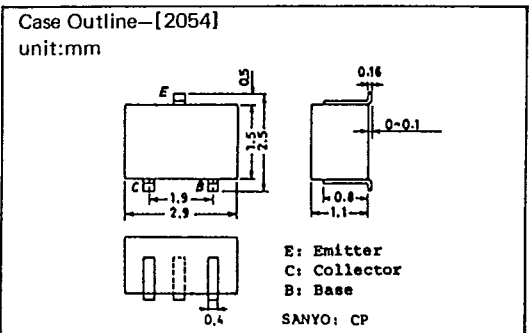
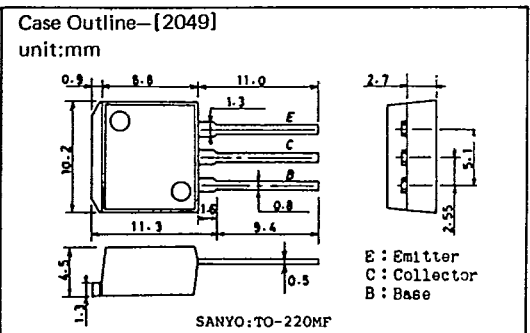
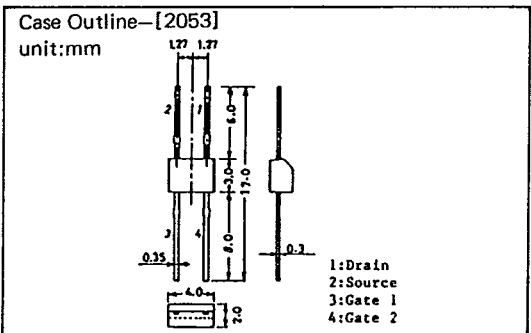
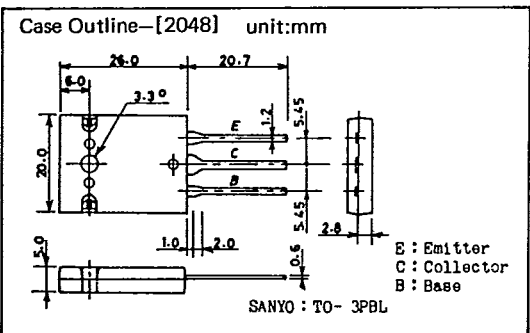
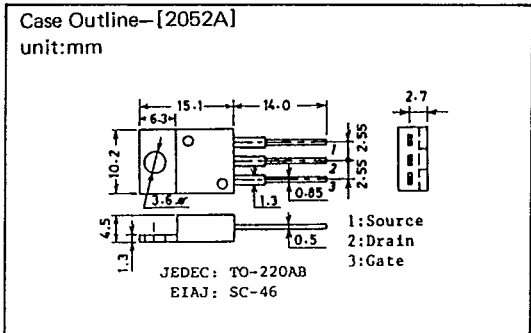
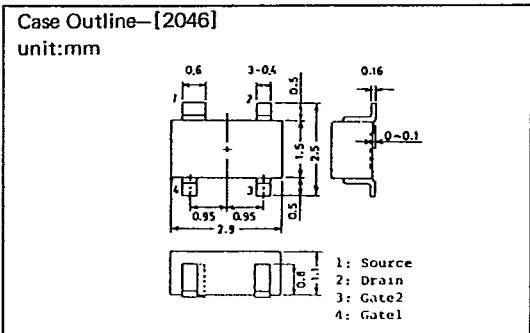
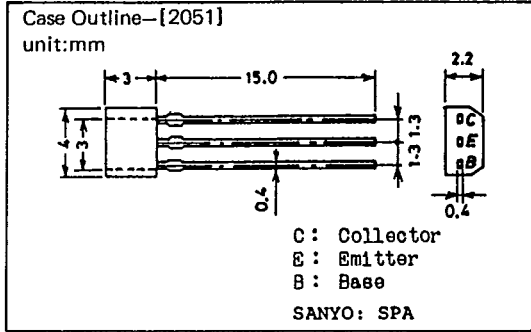
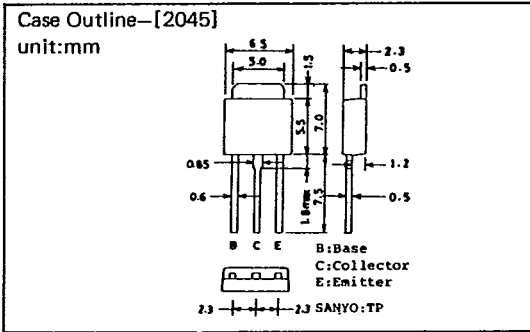
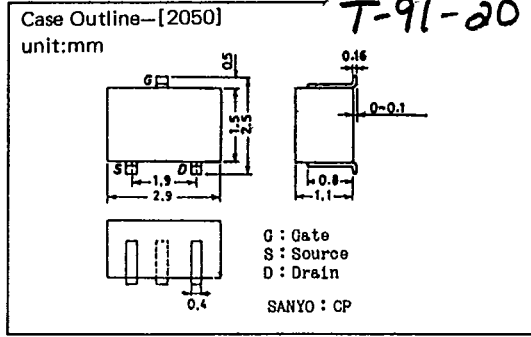
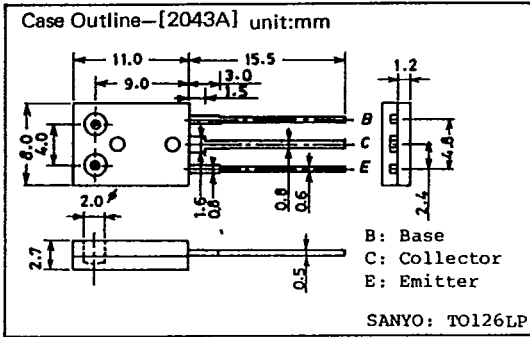

T-91-20

