

**TFT COLOR LCD MODULE
NL6448AC30-06**

**24 cm (9.4 inches), 640 × 480 pixels
4096 colors, incorporated backlight**

DESCRIPTION

NL6448AC30-06 is a TFT (thin film transistor) active matrix color liquid crystal display (LCD) comprising amorphous silicon TFT attached to each signal electrode, a driving circuit, and a backlight.

The 24 cm (9.4 inches) diagonal display area contains 640 x 480 pixels and can display 4096 colors simultaneously. By utilizing an edge light type backlight, a very thin profile design was achieved.

FEATURES

- Upward compatible with NL6448AC30-03 (brightness up and data enable function plus)
- Thin and light weight
- High contrast ratio, wide viewing angle, wide color gamut
- High-speed response
- High resolution
- Low power consumption
- Incorporated edge light type backlight
- Data enable function

APPLICATIONS

- Notebook personal computer (PC), word processor
- Display terminals for control system
- New media
- Control board for NC (numerical control) machine
- Monitors for process controller

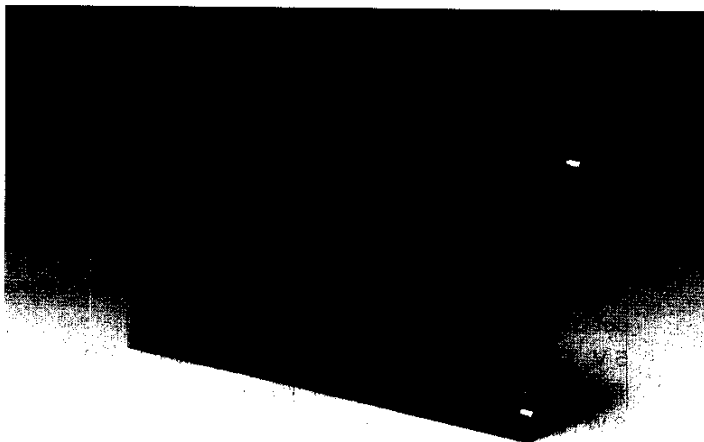

STRUCTURE AND FUNCTIONS

A TFT color LCD module comprises a TFT LCD panel, LSIs for driving liquid crystal, and the backlight. The TFT LCD panel is composed of a TFT array glass substrate superimposed on a color filter glass substrate with liquid crystal filled in the narrow gap between two substrates. The backlight apparatus is located on the backside of the LCD panel.

RGB (Red, Green, Blue) data signals are sent to LCD panel drivers after modulation into suitable forms for active matrix addressing through signal processor.

Each of the liquid crystal cells acts as an electro-optical switch that controls the light transmission from the backlight by a signal applied to a signal electrode through the TFT switch.

BLOCK DIAGRAM

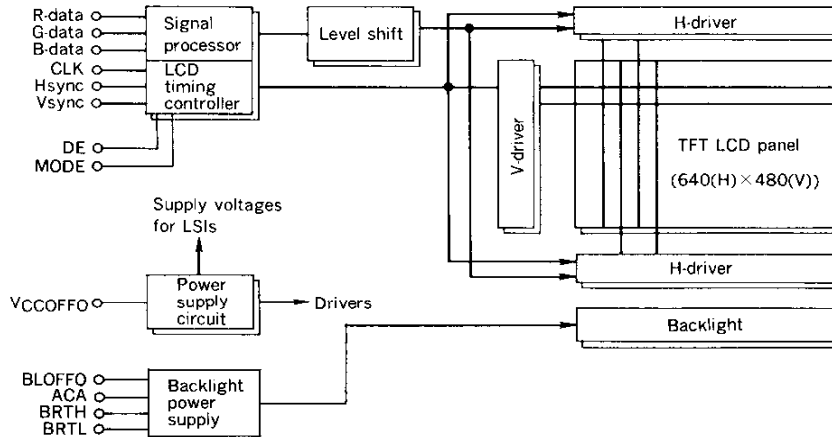

OUTLINE OF CHARACTERISTICS (at room temperature)

Display area	192(H) x 144(V) mm (diagonal size 9.4 inches)
Drive system	a-Si TFT active matrix
Display colors	4096 colors
Number of pixels	640 x 480 pixels
Pixel arrangement	RGB vertical stripe
Pixel pitch	0.30(H) x 0.30(V) mm
Module size	259.5±1(H) x 179±1(V) x 12.5(D) mm
Weight	680 g (TYP.)
Contrast ratio	110:1 (TYP.)
Viewing angle (within the contrast ratio of 10:1)	Horizontal: 45° (TYP. left side, right side) Vertical : 30° (TYP. up side), 30° (TYP. down side)
Optimum viewing angle	Horizontal: 0°, Vertical: up 10°
Color gamut	55 % (TYP. center, to NTSC)
Response time	40 msec. (MAX.)
Luminance	90 cd/m ² (TYP.)
Signal system	4-bit digital signals for each of RGB primary colors, synchronous signals (Hsync, Vsync), dot clock (CLK)
Supply voltages	5 V, 12 V (AC adapter mode) or 7.2 V (battery mode)
Backlight	Fluorescent lamps with inverter (cold cathode type)
Power consumption	8 W (TYP.)

GENERAL SPECIFICATION

Item	Specification	Unit
Module size	259.5±1(H) x 179.0±1(V) x 12.5 MAX. (D)	mm
Display area	192(H) x 144(V) (diagonal size 9.4 inch)	mm
Number of pixels	640(H) x 480(V)	pixel
Dot pitch	0.10(H) x 0.30(V)	mm
Pixel pitch	0.30(H) x 0.30(V)	mm
Pixel arrangement	RGB(Red, Green, Blue) vertical stripe	
Display colors	4 096	color
Weight	690 (MAX.)	g

An inverter is incorporated within the module. (A luminance control variable resistor is extra)

ABSOLUTE MAXIMUM RATINGS

Parameter	Symbol	Rating	Unit	Remarks
Supply voltage	V _{DD}	0 to 20.5	V	T _a = 25 °C
	V _{CC}	-0.3 to 7	V	
Input voltage	V _I	-0.3 to V _{CC} + 0.3	V	
Storage temp.	T _{ST}	-20 to 60	°C	
Operation temp.	T _{OP}	0 to 50	°C	Module surface *
Humidity		≤ 95 % relative humidity		T _a = 40 °C
		≤ 85 % relative humidity		T _a = 50 °C
		absolute humidity shall not exceed T _a = 50 °C, 85 % relative humidity level		T _a > 50 °C

* measured at center of display area

ELECTRICAL CHARACTERISTICS

(1) Logic, LCD driving

T_a = 25 °C

Parameter	Symbol	MIN.	TYP.	MAX.	Unit	Note
Supply voltage	V _{CC}	4.75	5.0	5.25	V	T _a = 25 °C
Logic input "L"	V _{IL}	0	-	0.8	V	T _a = 25 °C, TTL
Logic input "H"	V _{IH}	2.0	-	V _{CC}	V	T _a = 25 °C, TTL
Supply current	I _{CC}	-	-	400	mA	V _{CC} = 5.0 V

(2) Backlight

T_a = 25 °C

Parameter	Symbol	MIN.	TYP.	MAX.	Unit	Note
Supply voltage	V _{DD}	6.0	7.2	20.0	V	
Power consumption	P _{DD}	-	-	8.4	W	ACA = L, V _{DD} = 6 V
		-	-	6.0	W	ACA = H, V _{DD} = 14 V
		-	-	6.5	W	ACA = H, V _{DD} = 7.2 V

SUPPLY VOLTAGE SEQUENCE

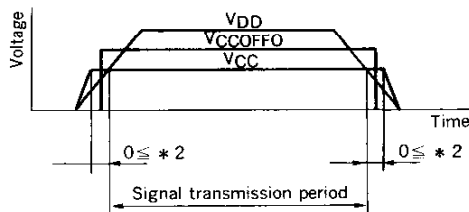

*1 The supply voltage of the external driver for input signals should be the same as V_{CC}.

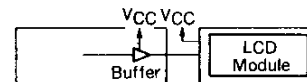

- *2 Apply V_{DD} within the LCD operation period. When the backlight turns on before LCD operation or the LCD operation turns off before the backlight turns off, the display may momentarily become white.
- *3 When a battery is used as V_{DD}, the backlight must be controlled by BL_{OFFO} (backlight ON/OFF signal).
- *4 In the case of V_{CCOFFO} = low level, please keep whole data and synchronous signals low level or high impedance.

INTERFACE PIN CONNECTION

(1) Interface signals, power supply

Connector: IL-Z-10P-S125L3-E + IL-Z-13P-S125L3-E + IL-Z-11P-S125L3-E (JAE)

(CN1: No.1 to 10) (CN2: No.11 to 23) (CN3: No.24 to 34)

Pin No.	Symbol	Function
1	CLK	Dot clock
2	GND	
3	GND	
4	H _{sync}	Horizontal sync.
5	V _{sync}	Vertical sync.
6	GND	
7	R ₀	Red data (LSB)
8	R ₁	Red data
9	R ₂	Red data
10	R ₃	Red data (MSB)
11	GND	
12	G ₀	Green data (LSB)
13	G ₁	Green data
14	G ₂	Green data
15	G ₃	Green data (MSB)
16	GND	
17	B ₀	Blue data (LSB)

Pin No.	Symbol	Function
18	B ₁	Blue data
19	B ₂	Blue data
20	B ₃	Blue data (MSB)
21	GND	
22	ACA	AC adapter IN ¹⁾
23	BL _{OFFO}	backlight ON/OFF ²⁾
24	GND	
25	V _{CC}	logic
26	V _{DD}	backlight
27	V _{DD}	backlight
28	NC	
29	GNDB ⁵⁾	backlight
30	GNDB ⁵⁾	backlight
31	DE	data enable
32	MODE	MODE ⁴⁾
33	V _{CCOFFO}	V _{CC} ON/OFF ³⁾
34	GND	

1) ACA: L = AC adapter mode, H = battery mode

2) BL_{OFFO}: L = backlight OFF, H = backlight ON

3) V_{CCOFFO}: L = V_{CC} OFF, H = V_{CC} ON

4) MODE: L = fixed timing mode (common to 03), H = DE mode

5) The GND is separated from the GNDB in the LCD module. (The GNDB is connected to the frame of the LCD module.)

(2) External variable resistor

1) Connector for luminance control (on the left side): IL-Z-2P-S125L3-E(JAE)

(CN4: No.1 to 2)

Pin No.	Symbol	Function
1	BRTH	luminance control input

Pin No.	Symbol	Function
2	BRTL	luminance control input

Note: The variable resistor for luminance control should be 1 kΩ type, and zero point of the resistor should correspond to the minimum of luminance.

2) Connector for luminance control (on the right back): LZ-5P-SL-SMT(JAE)

(CN5: No.1 to 5)

Pin No.	Symbol	Function
1	BRTH	luminance control input
3	BRTL	luminance control input
5	NC	

Pin No.	Symbol	Function
2	BRTH	luminance control input
4	BRTL	luminance control input

Note: The pins for BRTH and BRTL of luminance control connector on the left side (CN4) and the right back (CN5) are connected through each to each in the module.
Then, any one pair of the pins are available for luminance control variable resistor.

DISPLAY COLORS vs. INPUT DATA SIGNALS

	Display	Data signals (0: Low level, 1: High level)											
		R3	R2	R1	R0	G3	G2	G1	G0	B3	B2	B1	B0
Basic colors	Black	0	0	0	0	0	0	0	0	0	0	0	0
	Blue	0	0	0	0	0	0	0	0	1	1	1	1
	Red	1	1	1	1	0	0	0	0	0	0	0	0
	Magenta	1	1	1	1	0	0	0	0	1	1	1	1
	Green	0	0	0	0	1	1	1	1	0	0	0	0
	Cyane	0	0	0	0	1	1	1	1	1	1	1	1
	Yellow	1	1	1	1	1	1	1	1	0	0	0	0
	White	1	1	1	1	1	1	1	1	1	1	1	1
Red grayscale	Black	0	0	0	0	0	0	0	0	0	0	0	0
	Dark	0	0	0	1	0	0	0	0	0	0	0	0
	Bright	1	1	0	1	0	0	0	0	0	0	0	0
	Red	1	1	1	1	0	0	0	0	0	0	0	0
Green grayscale	Black	0	0	0	0	0	0	0	0	0	0	0	0
	Dark	0	0	0	0	0	0	0	1	0	0	0	0
	Bright	0	0	0	0	1	1	0	1	0	0	0	0
	Green	0	0	0	0	1	1	1	0	0	0	0	0
Blue grayscale	Black	0	0	0	0	0	0	0	0	0	0	0	0
	Dark	0	0	0	0	0	0	0	0	0	0	0	1
	Bright	0	0	0	0	0	0	0	0	1	1	0	1
	Blue	0	0	0	0	0	0	0	0	1	1	1	1

Note: Colors are developed in combination with 4-bit signal (16 steps in grayscale) of each primary red, green, and blue color. This process can result in up to 4096 (16 x 16 x 16) colors.

FIXED TIMING MODE SPECIFICATIONS

(1) Input signal specifications (fixed timing mode)

MODE (Pin No.32 = Low)

Parameter	Symbol	MIN.	TYP.	MAX.	Unit	Remarks
CLK	1/Tc	21.0	25.175	29.0	MHz	39.722 ns (TYP.)
	Tch/Tc	0.4	0.5	0.6	—	
	Tcrf			10	ns	
Hsync	Th	30.0	31.778	33.6	μs	31.468 kHz (TYP.)
			800		CLK	
	Thd		25.422		μs	
			640		CLK	
	Thf		0.636		μs	
			16		CLK	
	Thp	10	3.813		μs	Thp + Thb = 144 CLK
			96		CLK	
	Thb		1.907		μs	
		48	134	CLK		
	Thch	12			ns	
	Thcs	8			ns	
	Tvh	15			ns	
	Tvs	15			ns	
	Thrf			10	ns	
Vsync	Tv	16.1	16.683	17.2	ms	59.94 Hz (TYP.)
			525		H	
	Tvd		15.253		ms	
			480		H	
	Tvf		0.381		ms	
			12		H	
	Tvp	2	0.063		ms	Tvp + Tvb = 33 H
		2		H		
	Tvb		0.985		ms	
			31		H	
	Tvrf			10	ns	
DATA R0-R3 G0-G3 B0-B3	Tds	8			ns	
	Tdh	12			ns	
	Tdrf			10	ns	

All of parameters should be kept in the specified range.

(2) Definition of input signal timing (fixed timing mode) Note 1

<Horizontal>

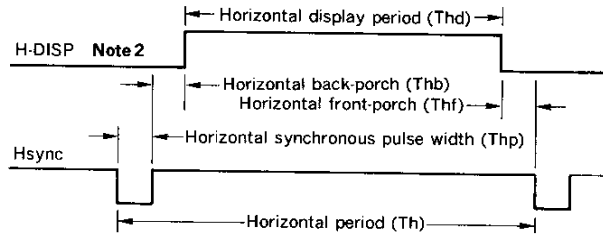

<Vertical>

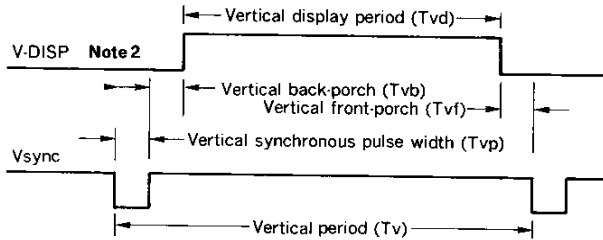

Note 1: Regarding how to count H/CLK, refer to the input signal timing chart of fixed timing mode. $T_{hp} + T_{hb}$ and $T_{vp} + T_{vb}$ are fixed. The display position will be wrong, when different values are selected.

Note 2: These signals do not exist.

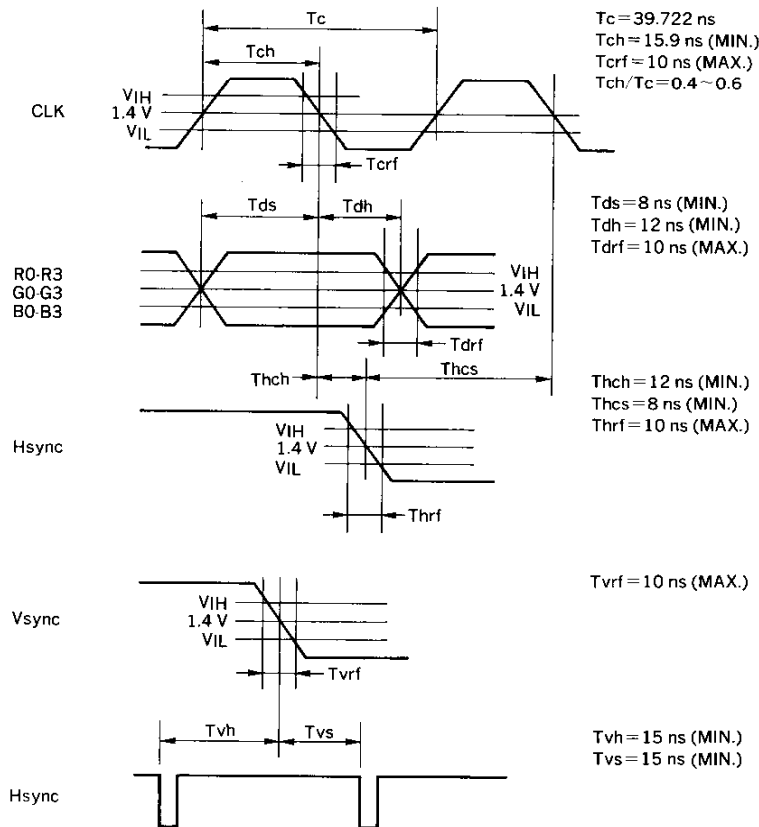

(3) Input signal timing chart (fixed timing mode)

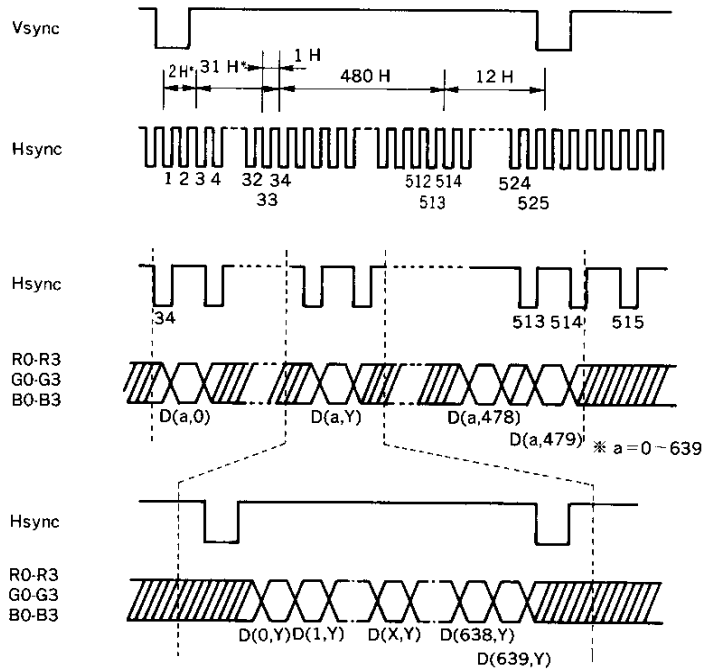

- *) T_{vp} (MIN.) is 2H.
- *) $T_{vp} + T_{vb} = 33H$ (Fixed).

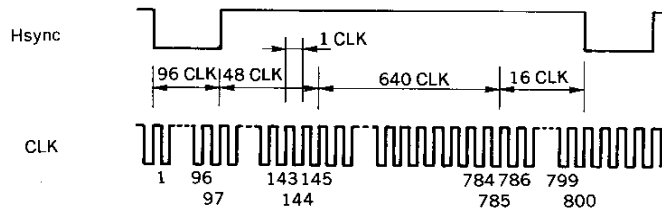

Display position of input data

D (0, 0)	D (1, 0)	---	D (X, 0)	---	D (638, 0)	D (639, 0)
D (0, 1)	D (1, 1)	---	D (X, 1)	---	D (638, 1)	D (639, 1)
⋮	⋮	⋮	⋮	⋮	⋮	⋮
D (0, Y)	D (1, Y)	---	D (X, Y)	---	D (638, Y)	D (639, Y)
⋮	⋮	⋮	⋮	⋮	⋮	⋮
D (0, 478)	D (1, 478)	---	D (X, 478)	---	D (638, 478)	D (639, 478)
D (0, 479)	D (1, 479)	---	D (X, 479)	---	D (638, 479)	D (639, 479)

- *) T_{hp} (MIN.) is 10 CLK.
- *) $T_{hp} + T_{hb} = 144$ CLK (Fixed).

DE MODE SPECIFICATIONS

(1) Input signal specifications (DE mode)

MODE (Pin No.32 = High)

Parameter	Symbol	MIN.	TYP.	MAX.	Unit.	Remarks
CLK	1/Tc	21.0	25.175	29.0	MHz	39.722 ns (TYP.)
	Tch/Tc	0.4	0.5	0.6	—	
	Tcrf			10	ns	
Hsync	Th	30.0	31.778	33.6	μs	31.468 kHz (TYP.)
			800		CLK	
	Thd		25,422 640		μs CLK	
	Thf	0 0	0.636 16		μs CLK	
	Thp	10	3.813 96		μs CLK	
	Thb	4	1.907 48		μs CLK	
	Thch	12			ns	
	Thcs	8			ns	
	Tvh	15			ns	
	Tvs	15			ns	
Vsync	Thrf			10	ns	
	Tv	16.1	16.683	17.2	ms	59.94 Hz (TYP.)
			525		H	
	Tvd		15,253 480		ms H	
	Tvf	0 0	0.381 12		ms H	
	Tvp	2	0.063 2		ms H	
	Tvb	4	0.985 31		ms H	
DATA R0-R3 G0-G3 B0-B3	Tvrf			10	ns	
	Tds	8			ns	
	Tdh	12			ns	
DE	Tdrf			10	ns	
	Tes	8			ns	
	Teh	12			ns	
	Terf			10	ns	

All of parameters should be kept in the specified range.

(2) Definition of input signal timing (DE mode) **Note**

<Horizontal>

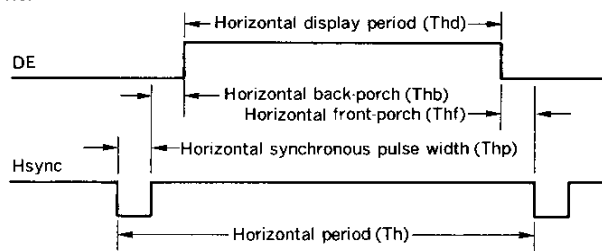

<Vertical>

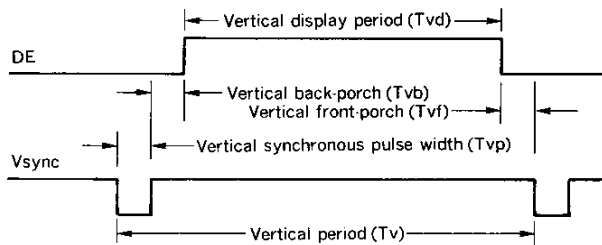

Note: Regarding how to count H/CLK, refer to the input signal timing (c) and (d) of DE mode.

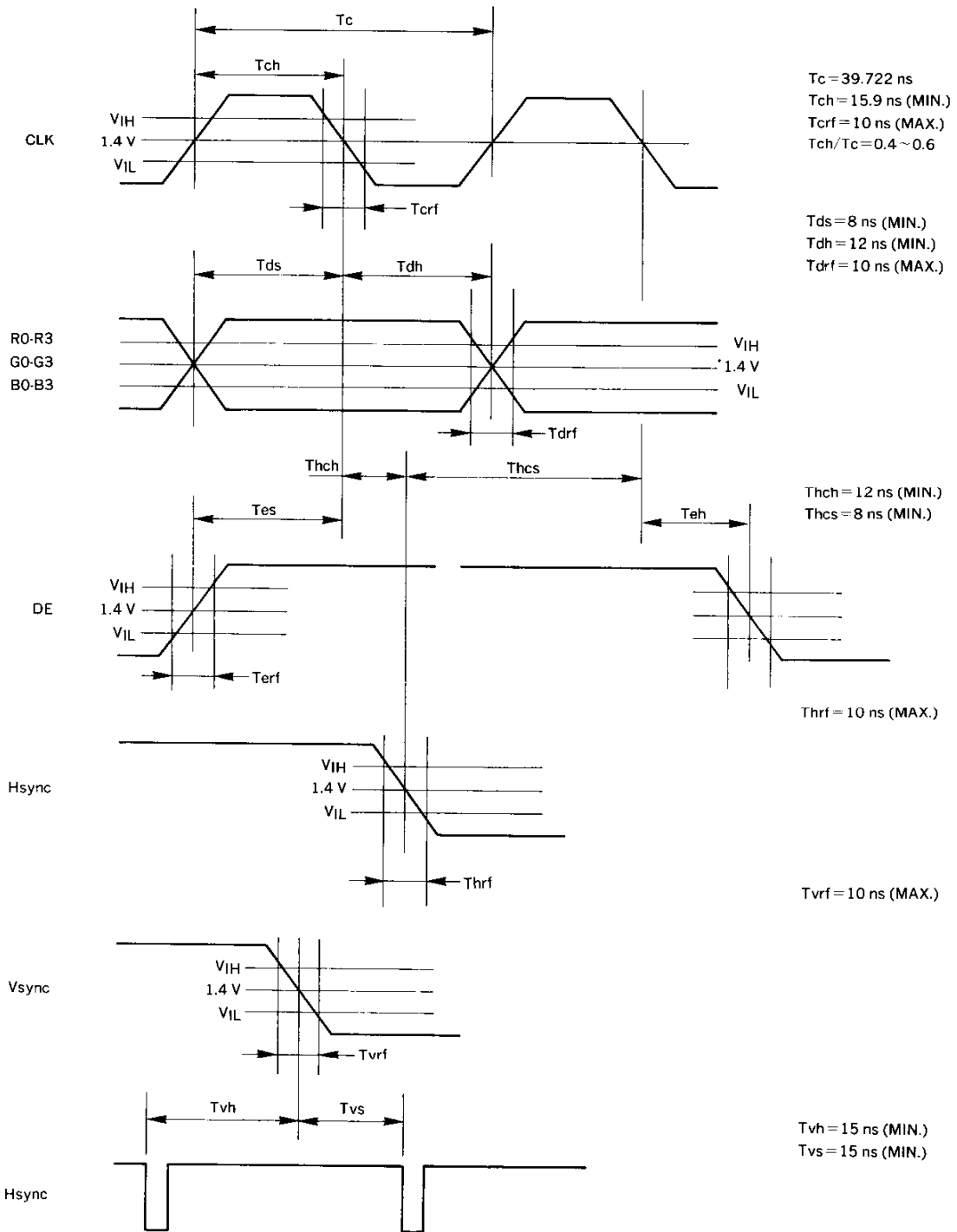

(3) Input signal timing chart (DE mode)

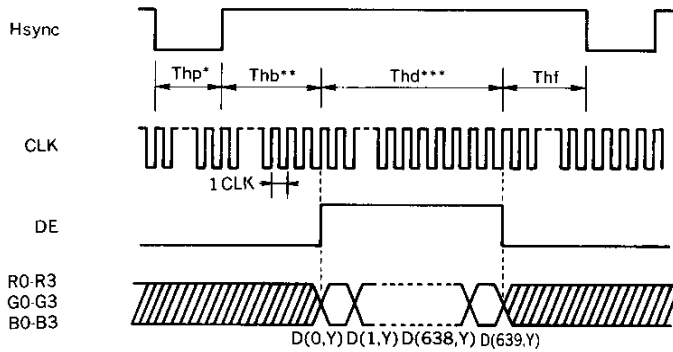
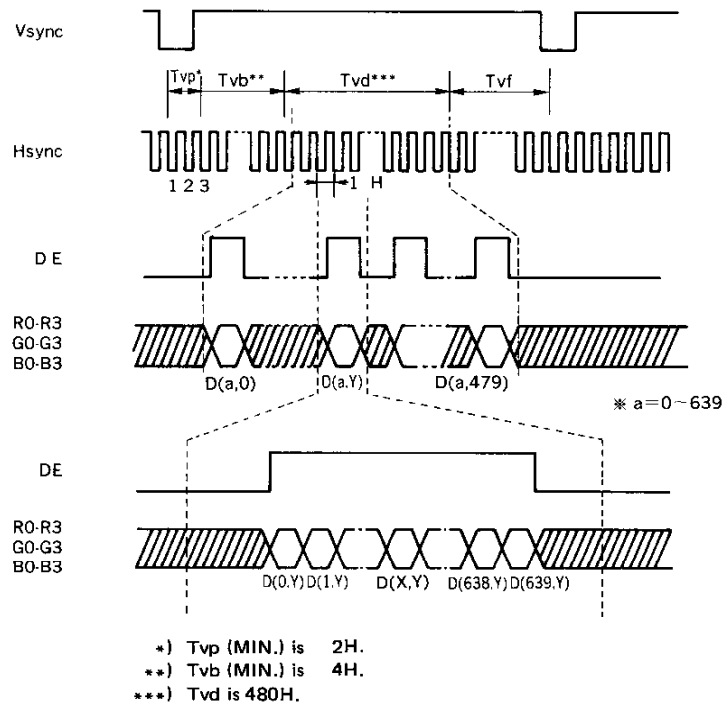

D (0, 0)	D (1, 0)	---	D (X, 0)	---	D (638, 0)	D (639, 0)
D (0, 1)	D (1, 1)	---	D (X, 1)	---	D (638, 1)	D (639, 1)
⋮	⋮	⋮	⋮	⋮	⋮	⋮
D (0, Y)	D (1, Y)	---	D (X, Y)	---	D (638, Y)	D (639, Y)
⋮	⋮	⋮	⋮	⋮	⋮	⋮
D (0, 478)	D (1, 478)	---	D (X, 478)	---	D (638, 478)	D (639, 478)
D (0, 479)	D (1, 479)	---	D (X, 479)	---	D (638, 479)	D (639, 479)

*) Thp (MIN.) is 10 CLK.
 **) Thb (MIN.) is 4 CLK.
 ***) Thd is 640 CLK.

GENERAL CAUTION

Liquid Crystal Display has the following specific characteristics. These are not defects or malfunctions.
 The display condition of LCD module may be affected by the ambient temperature.
 The LCD module uses cold cathode tubes for backlighting. Optical characteristics, like luminance or uniformity, will change during life time.
 Uneven brightness and/or small spots may be noticed depending on different display patterns.

- (1) As the electrostatic discharges may break the LCD module, handle the LCD module with care against electrostatic discharges. Peel protection sheet out from the LCD panel surface as slowly as possible.
- (2) As the LCD panel and backlight element are made from fragile glass material, impulse and pressure to the LCD module should be avoided.
- (3) As the surface of polarizer is very soft and easily scratched, use a soft dry cloth without chemicals for cleaning.
- (4) Do not pull the interface connectors in or out while the LCD module is operating.
- (5) Dew drop atmosphere should be avoided.
- (6) Do not store and/or operate the LCD module in a high temperature and/or high humidity atmosphere.
 Storage in an electro-conductive polymer packing pouch and under relatively low temperature atmosphere is recommended.
- (7) Do not touch an inverter while the LCD module is operating, because of dangerous high voltage.
- (8) Pick the conductive polymer pouch only itself when taking out a module from a carrier box.
- (9) When pulling the module out from the pouch, do not hold the shaded portion in the following figure.
- (10) Put the module display side down on the flat horizontal plane.
- (11) Keep hands out from TCP (Tape Carrier Packaging) type parts such as driver ICs in handling.
- (12) Do not apply fixed pattern data signal to the LCD module at product aging. Fixed pattern may cause image sticking.

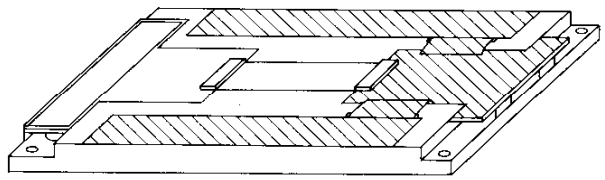

OUTLINE DRAWING (Unit in mm)

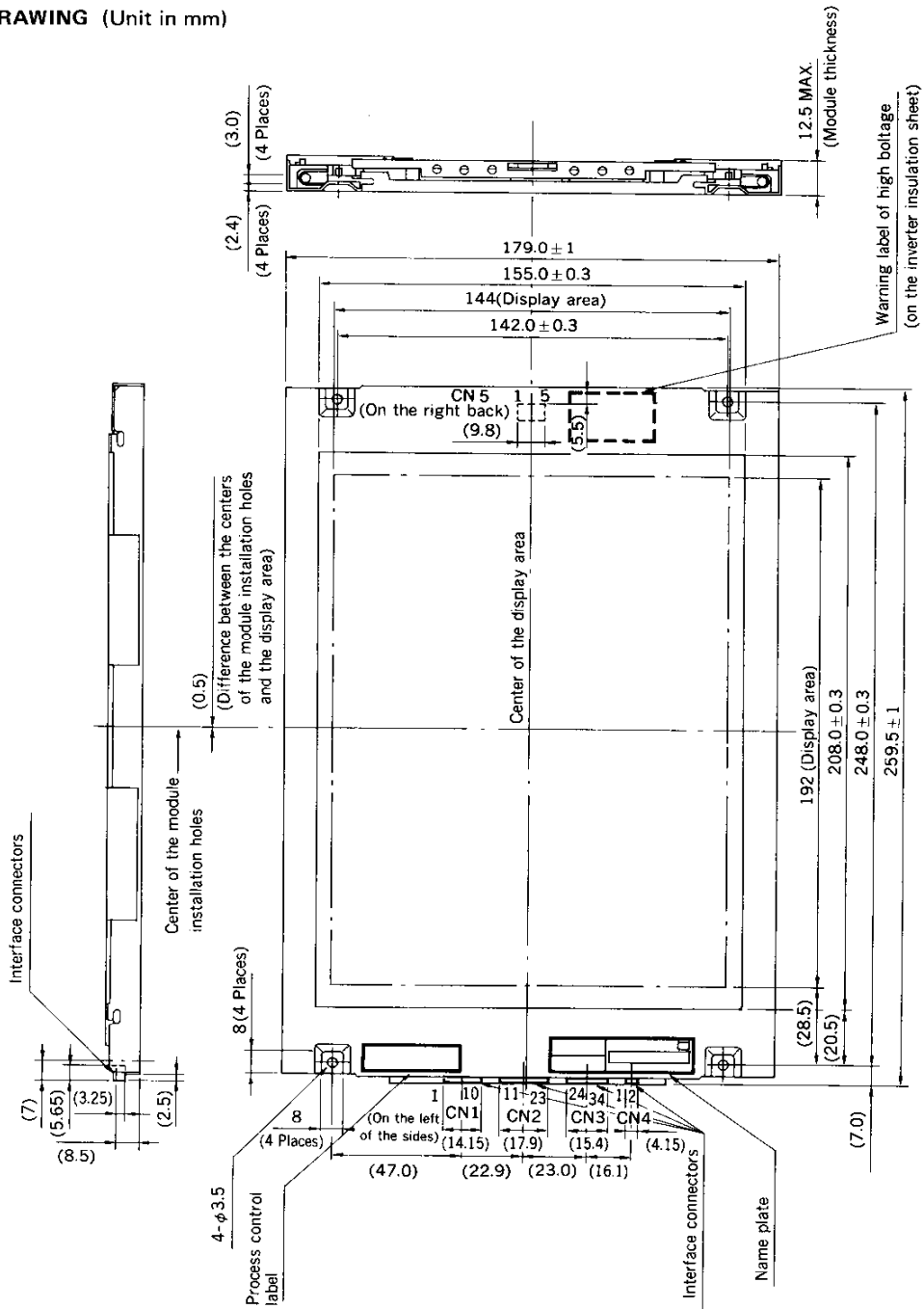

The information in this document is subject to change without notice.

No part of this document may be copied or reproduced in any form or by any means without the prior written consent of NEC Corporation. NEC Corporation assumes no responsibility for any errors which may appear in this document.

NEC Corporation does not assume any liability for infringement of patents, copyrights or other intellectual property rights of third parties by or arising from use of a device described herein or any other liability arising from use of such device. No license, either express, implied or otherwise, is granted under any patents, copyrights or other intellectual property rights of NEC Corporation or of others.