

NPN SILICON PLANAR MEDIUM POWER TRANSISTORS IN SOT89

Features

- $I_C = 1A$ Continuous Collector Current
- Low Saturation Voltage $V_{CE(sat)} < 500mV @ 0.5A$
- Gain groups 10 and 16
- Epitaxial Planar Die Construction
- Complementary PNP types: BCX51, 52 and 53
- **Lead-Free, RoHS Compliant (Note 1)**
- **Halogen and Antimony Free. "Green" Devices (Note 2)**
- **Qualified to AEC-Q101 Standards for High Reliability**

Mechanical Data

- Case: SOT89
- Case Material: Molded Plastic, "Green" Molding Compound (Note 2)
- UL Flammability Rating 94V-0
- Moisture Sensitivity: Level 1 per J-STD-020
- Terminals: Matte Tin Finish
- Weight: 0.072 grams (Approximate)

Applications

- Medium Power Switching or Amplification Applications
- AF driver and output stages

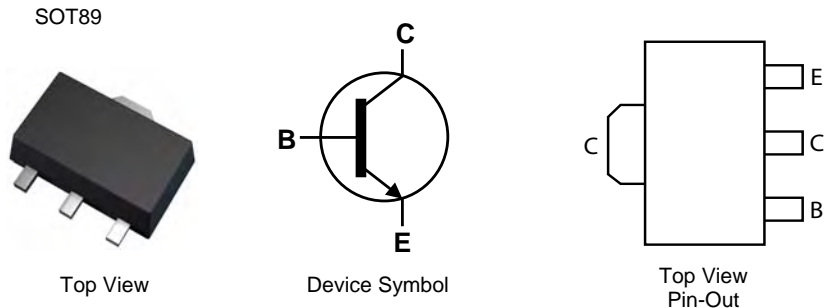

Ordering Information (Note 3)

| Product | Marking | Reel size (inches) | Tape width (mm) | Quantity per reel |
|-----------|---------|--------------------|-----------------|-------------------|
| BCX54TA | BA | 7 | 12 | 1,000 |
| BCX5410TA | BC | 7 | 12 | 1,000 |
| BCX5416TA | BD | 7 | 12 | 1,000 |
| BCX55TA | BE | 7 | 12 | 1,000 |
| BCX5510TA | BG | 7 | 12 | 1,000 |
| BCX5516TA | BM | 7 | 12 | 1,000 |
| BCX56TA | BH | 7 | 12 | 1,000 |
| BCX5610TA | BK | 7 | 12 | 1,000 |
| BCX5616TA | BL | 7 | 12 | 1,000 |
| BCX5316TC | BL | 13 | 12 | 4,000 |

- Notes:
1. No purposefully added lead.
 2. Diodes Inc's "Green" Policy can be found on our website at <http://www.diodes.com>
 3. For packaging details, go to our website <http://www.diodes.com>

Marking Information

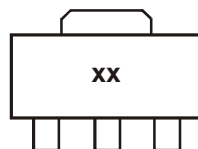

xx = Product Type Marking Code, as follows:

| | | |
|--------------|--------------|--------------|
| BCX54 = BA | BCX55 = BE | BCX56 = BH |
| BCX5410 = BC | BCX5510 = BG | BCX5610 = BK |
| BCX5416 = BD | BCX5516 = BM | BCX5616 = BL |

Maximum Ratings @ $T_A = 25^\circ\text{C}$ unless otherwise specified

| Characteristic | Symbol | BCX54 | BCX55 | BCX56 | Unit |
|------------------------------|-----------|-------|-------|-------|------|
| Collector-Base Voltage | V_{CBO} | 45 | 60 | 100 | V |
| Collector-Emitter Voltage | V_{CEO} | 45 | 60 | 80 | V |
| Emitter-Base Voltage | V_{EBO} | 5 | | | V |
| Continuous Collector Current | I_C | 1 | | | A |
| Peak Pulse Collector Current | I_{CM} | 1.5 | | | |
| Continuous Base Current | I_B | 100 | | | mA |
| Peak Pulse Base Current | I_{BM} | 200 | | | |

Thermal Characteristics @ $T_A = 25^\circ\text{C}$ unless otherwise specified

| Characteristic | Symbol | Value | Unit |
|--|-----------------|-------------|--------------------|
| Power Dissipation (Note 4) | P_D | 1 | W |
| Thermal Resistance, Junction to Ambient (Note 4) | $R_{\theta JA}$ | 124 | $^\circ\text{C/W}$ |
| Thermal Resistance, Junction to Leads (Note 5) | $R_{\theta JL}$ | 10.0 | $^\circ\text{C/W}$ |
| Operating and Storage Temperature Range | T_J, T_{STG} | -65 to +150 | $^\circ\text{C}$ |

- Notes:
4. For a device surface mounted on 25mm X 25mm FR4 PCB with high coverage of single sided 1 oz copper, in still air conditions; the device is measured when operating in a steady-state condition.
 5. Thermal resistance from junction to solder-point (on the exposed collector pad).

Thermal Characteristics

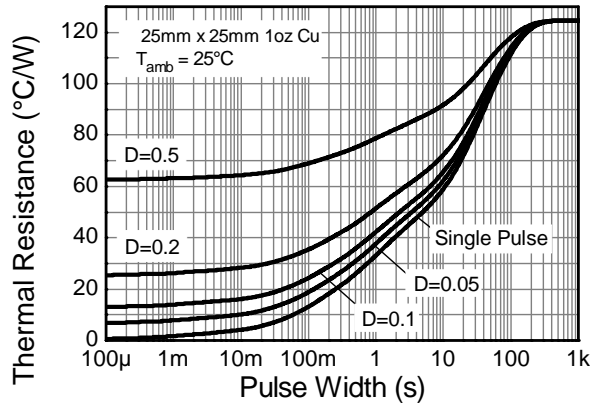

Transient Thermal Impedance

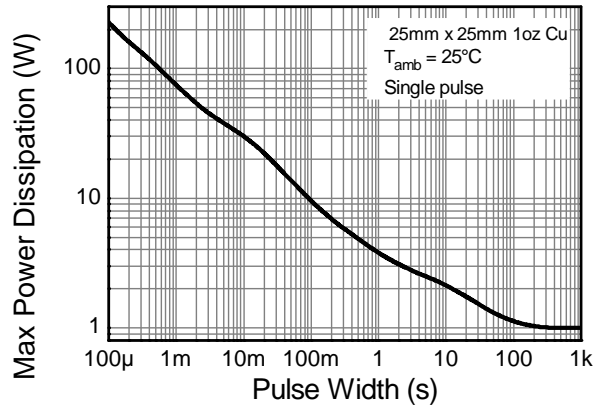

Pulse Power Dissipation

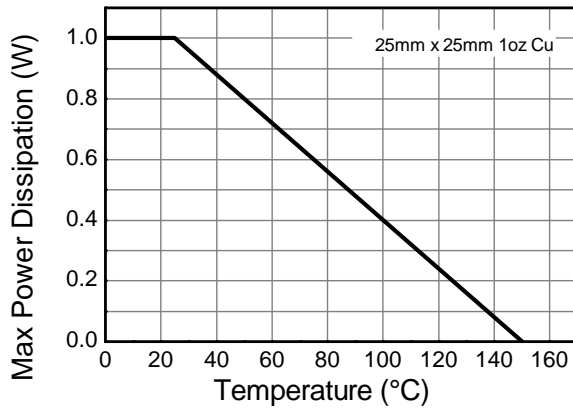

Derating Curve

Electrical Characteristics @ $T_A = 25^\circ\text{C}$ unless otherwise specified

| Characteristic | Symbol | Min | Typ | Max | Unit | Test Condition |
|--|---------------|-----|-----|-----------|---------------|--|
| Collector-Base Breakdown Voltage | BV_{CBO} | 45 | - | - | V | $I_C = 100\mu\text{A}$ |
| | | 60 | | | | |
| | | 100 | | | | |
| Collector-Emitter Breakdown Voltage (Note 6) | BV_{CEO} | 45 | - | - | V | $I_C = 10\text{mA}$ |
| | | 60 | | | | |
| | | 80 | | | | |
| Emitter-Base Breakdown Voltage | BV_{EBO} | 5 | - | - | V | $I_E = 10\mu\text{A}$ |
| Collector Cut-off Current | I_{CBO} | - | - | 0.1 20 | μA | $V_{CB} = 30\text{V}$ $V_{CB} = 30\text{V}, T_A = 150^\circ\text{C}$ |
| Emitter Cut-off Current | I_{EBO} | - | - | 20 | nA | $V_{EB} = 4\text{V}$ |
| Static Forward Current Transfer Ratio (Note 6) | h_{FE} | 25 | - | - | | $I_C = 5\text{mA}, V_{CE} = 2\text{V}$ $I_C = 150\text{mA}, V_{CE} = 2\text{V}$ $I_C = 500\text{mA}, V_{CE} = 2\text{V}$ |
| | | 40 | - | 250 | | |
| | | 25 | - | - | | |
| | 10 gain grp | 63 | - | 160 | | $I_C = 150\text{mA}, V_{CE} = 2\text{V}$ |
| | 16 gain grp | 100 | - | 250 | | $I_C = 150\text{mA}, V_{CE} = 2\text{V}$ |
| Collector-Emitter Saturation Voltage (Note 6) | $V_{CE(sat)}$ | - | - | 0.5 | V | $I_C = 500\text{mA}, I_B = 50\text{mA}$ |
| Base-Emitter Turn-On Voltage (Note 6) | $V_{BE(on)}$ | - | - | 1.0 | V | $I_C = 500\text{mA}, V_{CE} = 2\text{V}$ |
| Transition Frequency | f_T | 150 | - | - | MHz | $I_C = 50\text{mA}, V_{CE} = 10\text{V}$ $f = 100\text{MHz}$ |
| Output Capacitance | C_{obo} | - | - | 25 | pF | $V_{CB} = 10\text{V}, f = 1\text{MHz}$ |

Notes: 6. Measured under pulsed conditions. Pulse width $\leq 300\mu\text{s}$. Duty cycle $\leq 2\%$.

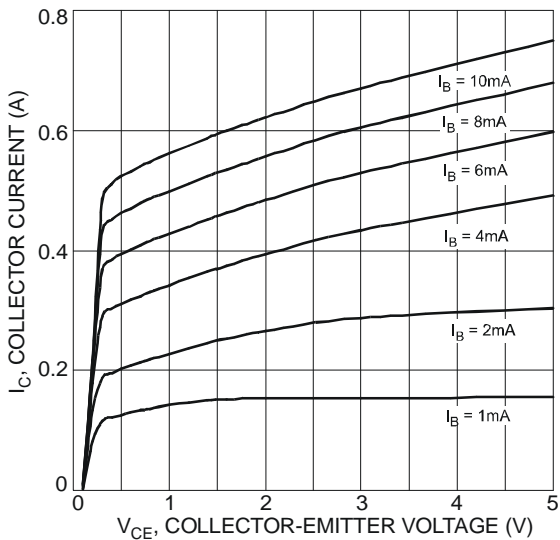

Fig. 1 Typical Collector Current vs. Collector-Emitter Voltage

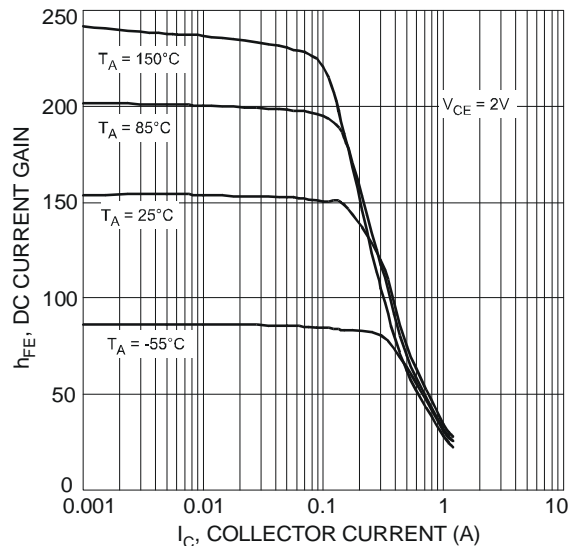

Fig. 2 Typical DC Current Gain vs. Collector Current

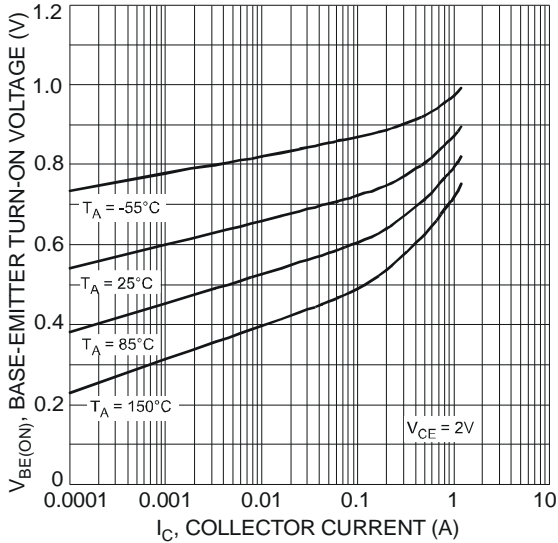

Fig. 3 Typical Base-Emitter Turn-On Voltage vs. Collector Current

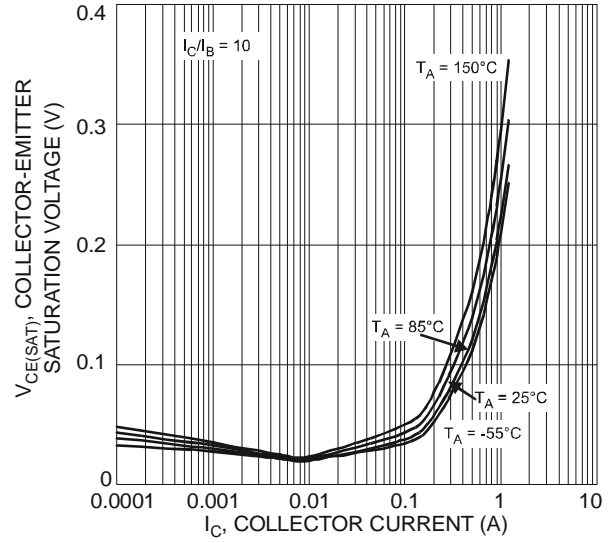

Fig. 4 Typical Collector-Emitter Saturation Voltage vs. Collector Current

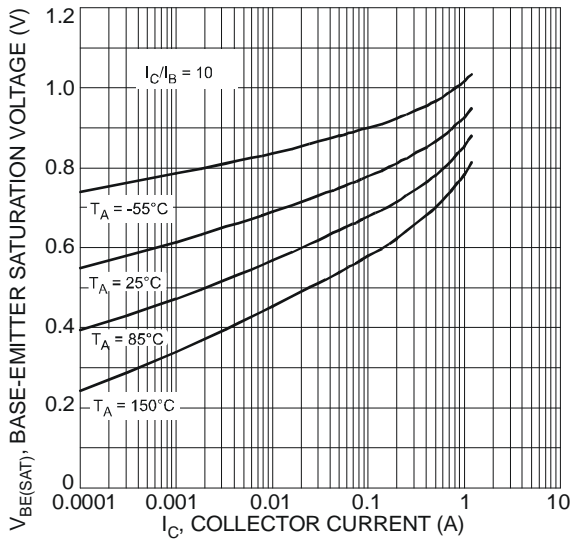

Fig. 5 Typical Base-Emitter Saturation Voltage vs. Collector Current

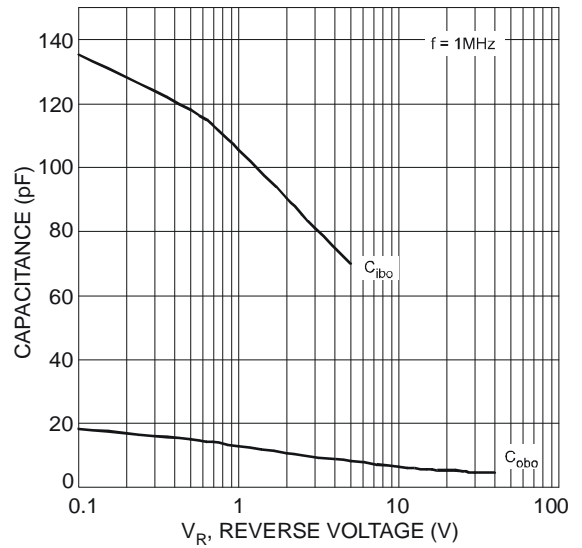

Fig. 6 Typical Capacitance Characteristics

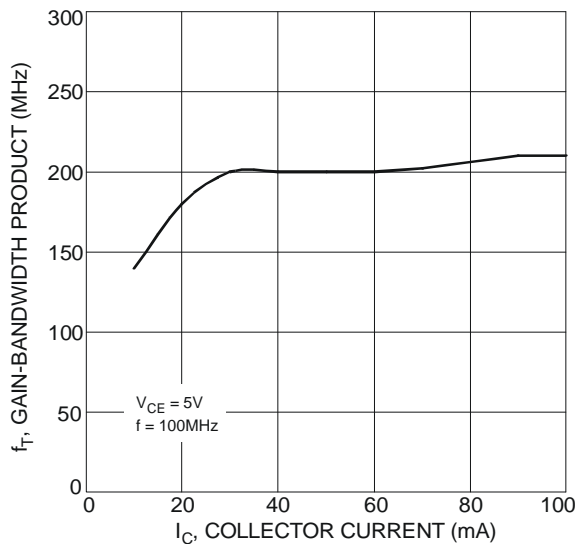
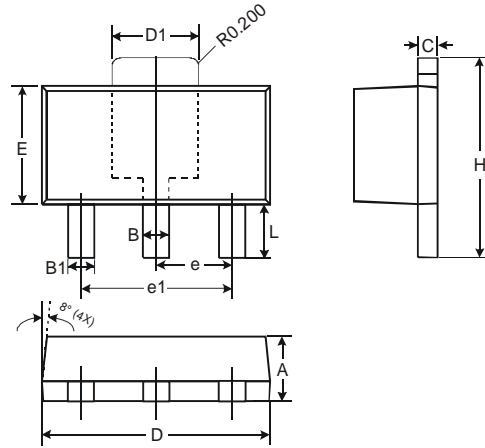

Fig. 7 Typical Gain-Bandwidth Product vs. Collector Current

Package Outline Dimensions



| SOT89 | | |
|----------------------|----------|------|
| Dim | Min | Max |
| A | 1.40 | 1.60 |
| B | 0.44 | 0.62 |
| B1 | 0.35 | 0.54 |
| C | 0.35 | 0.43 |
| D | 4.40 | 4.60 |
| D1 | 1.52 | 1.83 |
| E | 2.29 | 2.60 |
| E | 1.50 Typ | |
| e1 | 3.00 Typ | |
| H | 3.94 | 4.25 |
| L | 0.89 | 1.20 |
| All Dimensions in mm | | |

Suggested Pad Layout

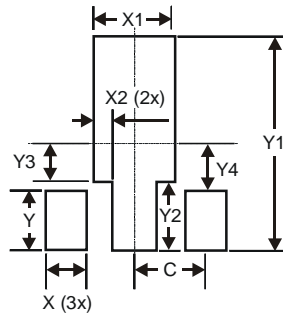

| Dimensions | Value (in mm) |
|------------|---------------|
| X | 0.900 |
| X1 | 1.733 |
| X2 | 0.416 |
| Y | 1.300 |
| Y1 | 4.600 |
| Y2 | 1.475 |
| Y3 | 0.950 |
| Y4 | 1.125 |
| C | 1.500 |

IMPORTANT NOTICE

DIODES INCORPORATED MAKES NO WARRANTY OF ANY KIND, EXPRESS OR IMPLIED, WITH REGARDS TO THIS DOCUMENT, INCLUDING, BUT NOT LIMITED TO, THE IMPLIED WARRANTIES OF MERCHANTABILITY AND FITNESS FOR A PARTICULAR PURPOSE (AND THEIR EQUIVALENTS UNDER THE LAWS OF ANY JURISDICTION).

Diodes Incorporated and its subsidiaries reserve the right to make modifications, enhancements, improvements, corrections or other changes without further notice to this document and any product described herein. Diodes Incorporated does not assume any liability arising out of the application or use of this document or any product described herein; neither does Diodes Incorporated convey any license under its patent or trademark rights, nor the rights of others. Any Customer or user of this document or products described herein in such applications shall assume all risks of such use and will agree to hold Diodes Incorporated and all the companies whose products are represented on Diodes Incorporated website, harmless against all damages.

Diodes Incorporated does not warrant or accept any liability whatsoever in respect of any products purchased through unauthorized sales channel. Should Customers purchase or use Diodes Incorporated products for any unintended or unauthorized application, Customers shall indemnify and hold Diodes Incorporated and its representatives harmless against all claims, damages, expenses, and attorney fees arising out of, directly or indirectly, any claim of personal injury or death associated with such unintended or unauthorized application.

Products described herein may be covered by one or more United States, international or foreign patents pending. Product names and markings noted herein may also be covered by one or more United States, international or foreign trademarks.

LIFE SUPPORT

Diodes Incorporated products are specifically not authorized for use as critical components in life support devices or systems without the express written approval of the Chief Executive Officer of Diodes Incorporated. As used herein:

A. Life support devices or systems are devices or systems which:

1. are intended to implant into the body, or
2. support or sustain life and whose failure to perform when properly used in accordance with instructions for use provided in the labeling can be reasonably expected to result in significant injury to the user.

B. A critical component is any component in a life support device or system whose failure to perform can be reasonably expected to cause the failure of the life support device or to affect its safety or effectiveness.

Customers represent that they have all necessary expertise in the safety and regulatory ramifications of their life support devices or systems, and acknowledge and agree that they are solely responsible for all legal, regulatory and safety-related requirements concerning their products and any use of Diodes Incorporated products in such safety-critical, life support devices or systems, notwithstanding any devices- or systems-related information or support that may be provided by Diodes Incorporated. Further, Customers must fully indemnify Diodes Incorporated and its representatives against any damages arising out of the use of Diodes Incorporated products in such safety-critical, life support devices or systems.

Copyright © 2011, Diodes Incorporated

www.diodes.com