

Diode – Diode Module

Features

- Improved glass passivation for high reliability
- Exceptional stability at high temperatures
- High di/dt and dv/dt capabilities
- Low thermal resistance

Maximum Ratings ($T_A = 25^{\circ}\text{C}$ unless otherwise noted)

Parameter	Symbol	Values	Units
Maximum average forward current @ $T_J = 85^{\circ}\text{C}$	$I_{F(AV)}$	40	A
Maximum average RMS forward current	$I_{F(RMS)}$	63	A
Maximum non-repetitive surge current @ $t = 10\text{ms}$	I_{FSM}	900	A
Maximum I^2t for fusing @ $t = 10\text{ms}$	I^2t	7.2	kA^2s



M1 PACKAGE

Thermal & Mechanical Specifications ($T_A = 25^{\circ}\text{C}$ unless otherwise noted)

Parameter	Symbol	Values	Units
Operating junction temperature range	T_J	-65 to +125	$^{\circ}\text{C}$
Thermal resistance, junction to case	$R_{th(JC)}$	1.0	$^{\circ}\text{C/W}$

Electrical Characteristics ($T_A = 25^{\circ}\text{C}$ unless otherwise noted)

Parameter	Symbol	Values	Units
Maximum average on-state current, 180°C sinusoidal	$I_{T(max)}$	40	A
Maximum repetitive peak reverse voltage range	V_{RRM}	200 to 1600	V
Forward voltage drop	V_{FM}	1.25	V
RMS isolation voltage	V_{ISO}	2500	V

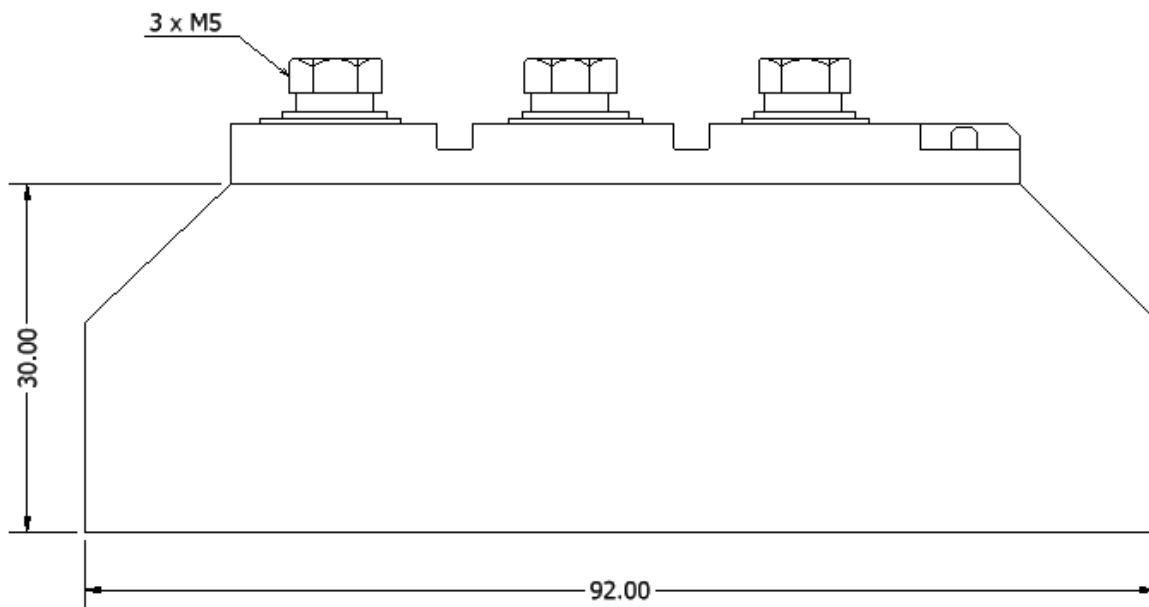
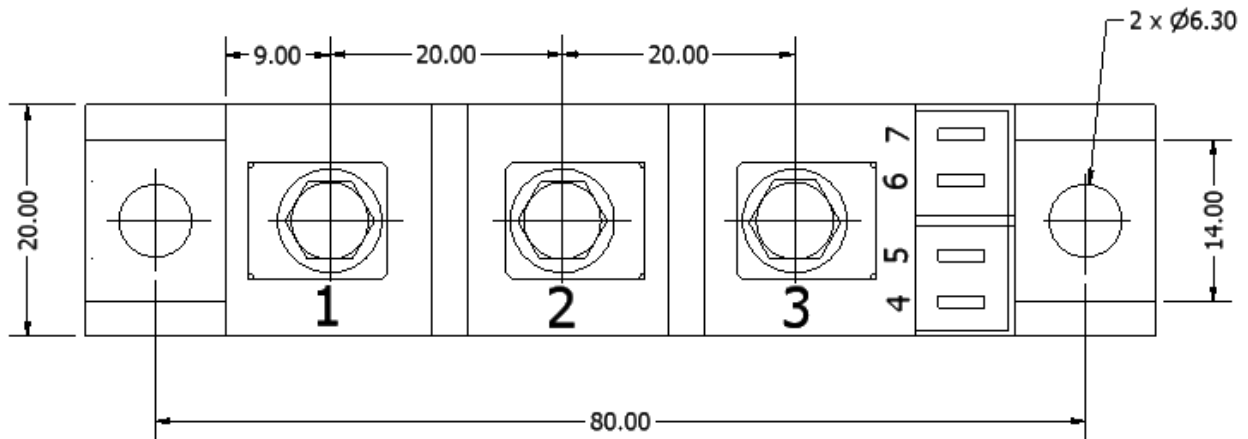

ALL DIMENSIONS ARE IN MM

Diode Configuration

