

■Features

- High Luminous LEDs
- 5mm Round Standard Directivity
- Long Lifetime Operation
- Superior Weather-resistance
- UV Resistant Epoxy/ Water Clear Type
- AC LED

■Applications

- Toys
- Audio
- Games
- Other Lighting

■Outline Dimension

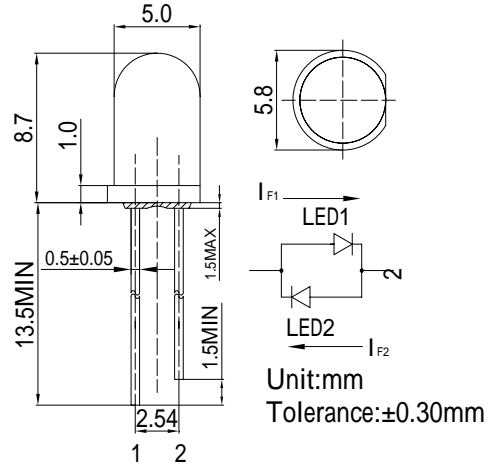

■Absolute Maximum Rating

(Ta=25)

Item	Symbol	Value		Unit
		LED1	LED2	
DC Forward Current	I_F	30	30	mA
Pulse Forward Current*	I_{FP}	100	100	mA
Reverse Voltage	V_R	5	5	V
Power Dissipation	P_D	108	108	mW
Operating Temperature	Topr	-30 ~ +85		
Storage Temperature	Tstg	-40~ +100		
Lead Soldering Temperature	Tsol	260 /5sec		-

*Pulse width Max.10ms Duty ratio max 1/10

■Directivity

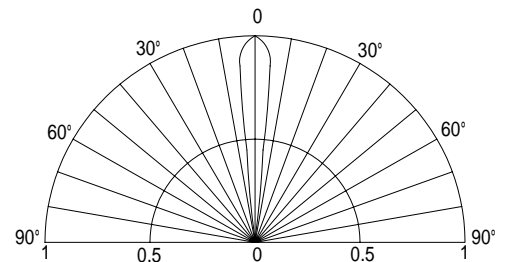

■Electrical -Optical Characteristics

(Ta=25)

Item	NO.	Symbol	Condition	Min.	Typ.	Max.	Unit
DC Forward Voltage	LED1	V_{F1}	$I_{F1}=20mA$	2.9	3.1	3.6	V
	LED2	V_{F2}	$I_{F2}=20mA$	2.9	3.1	3.6	V
Domi. Wavelength*	LED1	λ_{D1}	$I_{F1}=20mA$	465	470	475	nm
	LED2	λ_{D2}	$I_{F2}=20mA$	465	470	475	nm
Luminous Intensity*	LED1	I_{v1}	$I_{F1}=20mA$	4200	5800	-	mcd
	LED2	I_{v2}	$I_{F2}=20mA$	4200	5800	-	mcd
50%Power Angle	LED1	$2\theta_{1/2}$	$I_{F1}=20mA$	-	15	-	deg
	LED2	$2\theta_{1/2}$	$I_{F2}=20mA$	-	15	-	deg

*Tolerance of dominant chromaticity is ±10%

*2 Tolerance of luminous intensity is ±15%