



UCSP, Single-Supply, Low-Noise, Low-Distortion, Rail-to-Rail Op Amps

General Description

The MAX4249–MAX4257 low-noise, low-distortion operational amplifiers offer Rail-to-Rail® outputs and single-supply operation down to 2.4V. They draw 400µA of quiescent supply current per amplifier while featuring ultra-low distortion (0.0002% THD), as well as low input voltage noise density (7.9nV/√Hz) and low input current noise density (0.5fA/√Hz). These features make the devices an ideal choice for portable/battery-powered applications that require low distortion and/or low noise.

For additional power conservation, the MAX4249/4251/4253/4256 offer a low-power shutdown mode that reduces supply current to 0.5µA and puts the amplifiers' outputs into a high-impedance state. The MAX4249–MAX4257's outputs swing rail-to-rail and their input common-mode voltage range includes ground. The MAX4250–MAX4254 are unity-gain stable with a gain-bandwidth product of 3MHz. The MAX4249/MAX4255/MAX4256/MAX4257 are internally compensated for gains of +10V/V or greater with a gain-bandwidth product of 22MHz. The single MAX4250/MAX4255 are available in space-saving, 5-pin SOT23 packages. The MAX4252 is available in an 8-pin UCSP package and the MAX4253 is available in a 10-pin UCSP package.

Applications

Wireless Communications Devices
PA Control
Portable/Battery-Powered Equipment
Medical Instrumentation
ADC Buffers
Digital Scales/Strain Gauges

*Rail-to-Rail is a registered trademark of Nippon Motorola, Ltd.
UCSP is a trademark of Maxim Integrated Products, Inc.*

Features

- ♦ Available in Space-Saving UCSP™, SOT23, and µMAX Packages
- ♦ Low Distortion: 0.0002% THD (1kΩ load)
- ♦ 400µA Quiescent Supply Current per Amplifier
- ♦ Single-Supply Operation from +2.4V to +5.5V
- ♦ Input Common-Mode Voltage Range Includes Ground
- ♦ Outputs Swing Within 8mV of Rails with a 10kΩ Load
- ♦ 3MHz GBW Product, Unity-Gain Stable (MAX4250–MAX4254)
22MHz GBW Product, Stable with $A_V \geq 10V/V$ (MAX4249/MAX4255/MAX4256/MAX4257)
- ♦ Excellent DC Characteristics
 $V_{OS} = 70\mu V$
 $I_{BIAS} = 1pA$
Large-Signal Voltage Gain = 116dB
- ♦ Low-Power Shutdown Mode:
Reduces Supply Current to 0.5µA
Places Outputs in a High-Impedance State
- ♦ 400pF Capacitive-Load Handling Capability

Ordering Information

PART	TEMP. RANGE	PIN/BUMP-PACKAGE	TOP MARK
MAX4249ESD	-40°C to +85°C	14 SO	—
MAX4249EUB	-40°C to +85°C	10 µMAX	—
MAX4250EUK-T	-40°C to +85°C	5 SOT23-5	ACCI

Ordering Information continued at end of data sheet.
Selector Guide appears at end of data sheet.

Pin Configurations

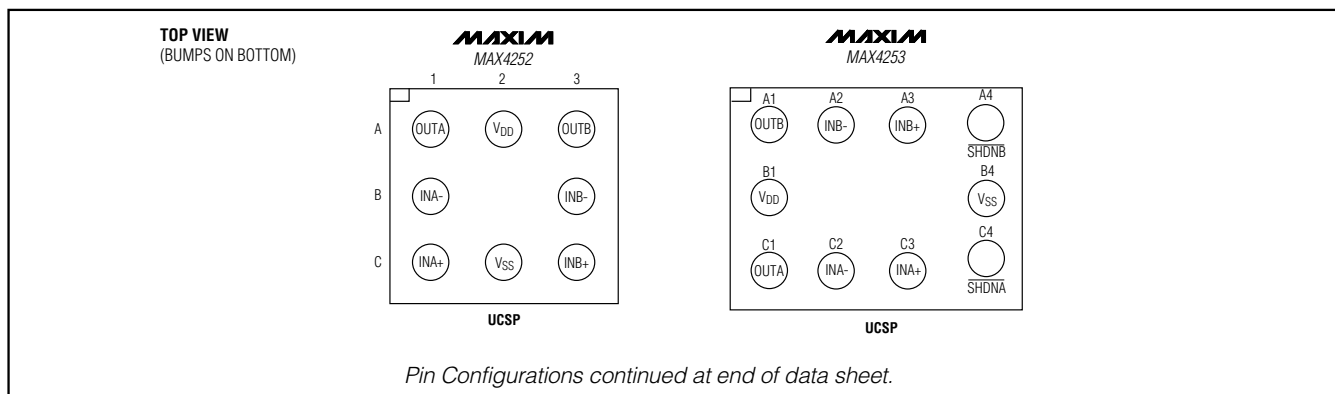

MAX4249–MAX4257

UCSP, Single-Supply, Low-Noise, Low-Distortion, Rail-to-Rail Op Amps

ABSOLUTE MAXIMUM RATINGS

Power-Supply Voltage (V_{DD} to V_{SS})+6.0V to -0.3V	10-Pin μ MAX (derate 5.6mW/°C above +70°C)444mW
Analog Input Voltage (IN_+ , IN_-)($V_{DD} + 0.3V$) to ($V_{SS} - 0.3V$)	14-Pin SO (derate 8.33mW/°C above +70°C)667mW
SHDN Input Voltage+6.0V to ($V_{SS} - 0.3V$)	Operating Temperature Range-40°C to +125°C
Output Short-Circuit Duration to Either SupplyContinuous	Junction Temperature+150°C
Continuous Power Dissipation ($T_A = +70^\circ\text{C}$)		Storage Temperature Range-65°C to +150°C
5-Pin SOT23 (derate 7.1mW/°C above +70°C)571mW	Lead Temperature (soldering, 10s)+300°C
8-Pin μ MAX (derate 4.5mW/°C above +70°C)362mW	Bump Temperature (soldering) (Note 1)	
8-Pin SO (derate 5.88mW/°C above +70°C)471mW	Infrared (15s)+220°C
8-Pin UCSP (derate 4.7mW/°C above +70°C)379mW	Vapor Phase (60s)+215°C
10-Pin UCSP (derate 6.1mW/°C above +70°C)484mW		

Note 1: This device is constructed using a unique set of packaging techniques that impose a limit on the thermal profile the device can be exposed to during board-level solder attach and rework. This limit permits only the use of the solder profiles recommended in the industry-standard specification, JEDEC 020A, paragraph 7.6, Table 3 for IR/VPR and Convection Reflow. Preheating is required. Hand or wave soldering is not allowed.

Stresses beyond those listed under "Absolute Maximum Ratings" may cause permanent damage to the device. These are stress ratings only, and functional operation of the device at these or any other conditions beyond those indicated in the operational sections of the specifications is not implied. Exposure to absolute maximum rating conditions for extended periods may affect device reliability.

ELECTRICAL CHARACTERISTICS

($V_{DD} = +5V$, $V_{SS} = 0$, $V_{CM} = 0$, $V_{OUT} = V_{DD}/2$, R_L tied to $V_{DD}/2$, $\overline{SHDN} = V_{DD}$, $T_A = -40^\circ\text{C}$ to $+125^\circ\text{C}$, unless otherwise noted. Typical values are at $T_A = +25^\circ\text{C}$.) (Notes 2, 3)

PARAMETER	SYMBOL	CONDITIONS	MIN	TYP	MAX	UNITS
Supply Voltage Range	V_{DD}	(Note 4)	2.4		5.5	V
Quiescent Supply Current per Amplifier	I_Q	Normal mode	$V_{DD} = +3V$	400		μA
			$V_{DD} = +5V$	420	575	
			$V_{DD} = +5V$, UCSP only	420	655	
		Shutdown mode ($\overline{SHDN} = V_{SS}$) (Note 2)		0.5	1.5	
Input Offset Voltage (Note 5)	V_{OS}			± 0.07	± 0.75	mV
Input Offset Voltage Tempco	TCV_{OS}			0.3		$\mu\text{V}/^\circ\text{C}$
Input Bias Current	I_B	(Note 6)		± 1	± 100	pA
Input Offset Current	I_{OS}	(Note 6)		± 1	± 100	pA
Differential Input Resistance	R_{IN}			1000		G Ω
Input Common-Mode Voltage Range	V_{CM}	Guaranteed by CMRR Test	-0.2		$V_{DD} - 1.1$	V
Common-Mode Rejection Ratio	CMRR	$V_{SS} - 0.2V \leq V_{CM} \leq V_{DD} - 1.1V$	70	115		dB
Power-Supply Rejection Ratio	PSRR	$V_{DD} = 2.4$ to $5.5V$	75	100		dB
Large-Signal Voltage Gain	A_V	$R_L = 10k\Omega$ to $V_{DD}/2$; $V_{OUT} = 25mV$ to $V_{DD} - 4.97V$	80	116		dB
		$R_L = 1k\Omega$ to $V_{DD}/2$; $V_{OUT} = 150V$ to $V_{DD} - 4.75V$	80	112		
Output Voltage Swing	V_{OUT}	$ V_{IN+} - V_{IN-} \geq 10mV$ $R_L = 10k\Omega$ to $V_{DD}/2$	$V_{DD} - V_{OH}$	8	25	mV
			$V_{OL} - V_{SS}$	7	20	

UCSP, Single-Supply, Low-Noise, Low-Distortion, Rail-to-Rail Op Amps

MAX4249-MAX4257

ELECTRICAL CHARACTERISTICS (continued)

($V_{DD} = +5V$, $V_{SS} = 0$, $V_{CM} = 0$, $V_{OUT} = V_{DD}/2$, R_L tied to $V_{DD}/2$, $\overline{SHDN} = V_{DD}$, $T_A = -40^\circ\text{C}$ to $+125^\circ\text{C}$, unless otherwise noted. Typical values are at $T_A = +25^\circ\text{C}$) (Notes 2, 3)

PARAMETER	SYMBOL	CONDITIONS		MIN	TYP	MAX	UNITS
Output Voltage Swing	V_{OUT}	$ V_{IN+} - V_{IN-} \geq 10\text{mV}$, $R_L = 1\text{k}\Omega$ to $V_{DD}/2$	$V_{DD} - V_{OH}$	77	200	mV	
			$V_{OL} - V_{SS}$	47	100		
Output Short-Circuit Current	I_{SC}			68		mA	
Output Leakage Current	I_{LEAK}	Shutdown mode ($\overline{SHDN} = V_{SS}$), $V_{OUT} = V_{SS}$ to V_{DD} (Note 2)		0.001	1.0	μA	
\overline{SHDN} Logic Low	V_{IL}	(Note 2)			$0.2 \times V_{DD}$	V	
\overline{SHDN} Logic High	V_{IH}	(Note 2)		$0.8 \times V_{DD}$		V	
\overline{SHDN} Input Current	I_{IL}/I_{IH}	$\overline{SHDN} = V_{SS} = V_{DD}$ (Note 2)		0.5	1.5	μA	
Input Capacitance				11		pF	
Gain Bandwidth Product	GBW	MAX4250-MAX4254		3		MHz	
		MAX4249/MAX4255/MAX4256/MAX4257		22			
Slew Rate	SR	MAX4250-MAX4254		0.3		V/ μs	
		MAX4249/MAX4255/MAX4256/MAX4257		2.1			
Peak-to-Peak Input Noise Voltage	$e_{n(p-p)}$	$f = 0.1\text{Hz}$ to 10Hz		760		nVp-p	
Input Voltage Noise Density	e_n	$f = 10\text{Hz}$		2.7		nV/ $\sqrt{\text{Hz}}$	
		$f = 1\text{kHz}$		8.9			
		$f = 30\text{kHz}$		7.9			
Input Current Noise Density	i_n	$f = 1\text{kHz}$		0.5		fA/ $\sqrt{\text{Hz}}$	
Total Harmonic Distortion Plus Noise	THD+N	MAX4250-MAX4254 $A_V = +1V/V$, $V_{OUT} = 2V_{p-p}$, $R_L = 1\text{k}\Omega$ to GND (Note 7)	$f = 1\text{kHz}$	0.0004		%	
			$f = 20\text{kHz}$	0.006			
		MAX4249/MAX4255/ MAX4256/MAX4257 $A_V = +1V/V$, $V_{OUT} = 2V_{p-p}$, $R_L = 1\text{k}\Omega$ to GND (Note 7)	$f = 1\text{kHz}$	0.0012			
			$f = 20\text{kHz}$	0.007			
Capacitive-Load Stability		No sustained oscillations		400		pF	
Gain Margin	GM	MAX4250-MAX4254, $A_V = +1V/V$		10		dB	
		MAX4249/MAX4255/MAX4256/MAX4257, $A_V = +10V/V$		12.5			
Phase Margin	Φ_M	MAX4250-MAX4254, $A_V = +1V/V$		74		degrees	
		MAX4249/MAX4255/MAX4256/MAX4257, $A_V = +10V/V$		68			

UCSP, Single-Supply, Low-Noise, Low-Distortion, Rail-to-Rail Op Amps

ELECTRICAL CHARACTERISTICS (continued)

($V_{DD} = +5V$, $V_{SS} = 0$, $V_{CM} = 0$, $V_{OUT} = V_{DD}/2$, R_L tied to $V_{DD}/2$, $\overline{SHDN} = V_{DD}$, $T_A = -40^\circ\text{C}$ to $+125^\circ\text{C}$, unless otherwise noted. Typical values are at $T_A = +25^\circ\text{C}$) (Notes 2, 3)

PARAMETER	SYMBOL	CONDITIONS	MIN	TYP	MAX	UNITS
Settling Time		T_0 0.01%, $V_{OUT} = 2V$ step	MAX4250-MAX4254	6.7		μs
			MAX4249/MAX4255/ MAX4256/MAX4257	1.6		
Delay Time to Shutdown	t_{SH}	$I_{VDD} = 5\%$ of normal operation	MAX4251/MAX4253	0.8		μs
			MAX4249/MAX4256	1.2		
Delay Time to Enable	t_{EN}	$V_{OUT} = 2.5V$, V_{OUT} settles to 0.1%	MAX4251/MAX4253	8		μs
			MAX4249/MAX4256	3.5		
Power-Up Delay Time	t_{PU}	$V_{DD} = 0$ to 5V step, V_{OUT} stable to 0.1%		6		μs

Note 2: \overline{SHDN} is available on the MAX4249/MAX4251/MAX4253/MAX4256 only.

Note 3: All device specifications are 100% tested at $T_A = +25^\circ\text{C}$. Limits over temperature are guaranteed by design.

Note 4: Guaranteed by the PSRR test.

Note 5: Offset voltage prior to reflow on UCSP.

Note 6: Guaranteed by design.

Note 7: Lowpass-filter bandwidth is 22kHz for $f = 1\text{kHz}$ and 80kHz for $f = 20\text{kHz}$. Noise floor of test equipment = $10\text{nV}/\sqrt{\text{Hz}}$.

UCSP, Single-Supply, Low-Noise, Low-Distortion, Rail-to-Rail Op Amps

Typical Operating Characteristics

($V_{DD} = +5V$, $V_{SS} = 0$, $V_{CM} = V_{OUT} = V_{DD}/2$, input noise floor of test equipment = $10nV/\sqrt{Hz}$ for all distortion measurements, $T_A = +25^\circ C$, unless otherwise noted.)

MAX4249-MAX4257

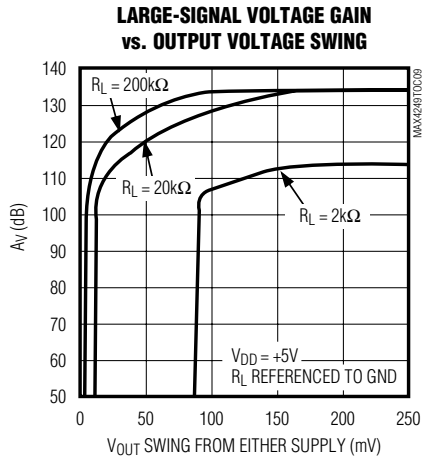
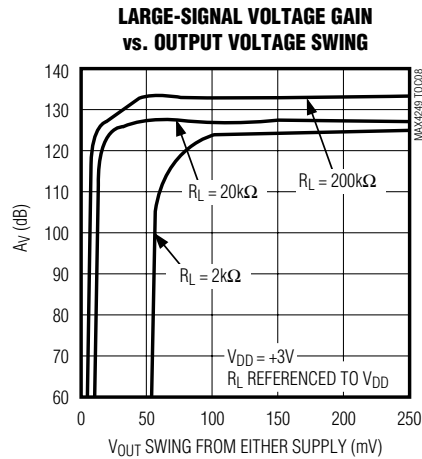
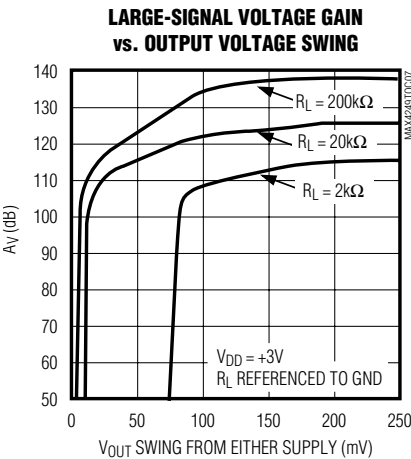
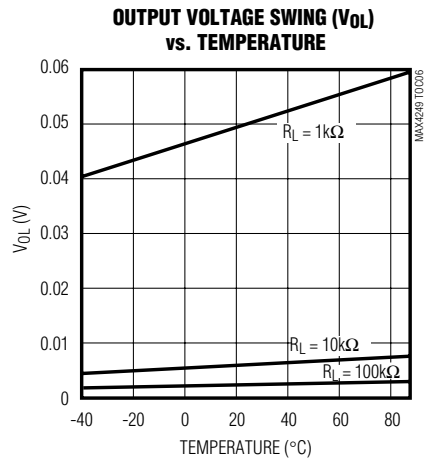
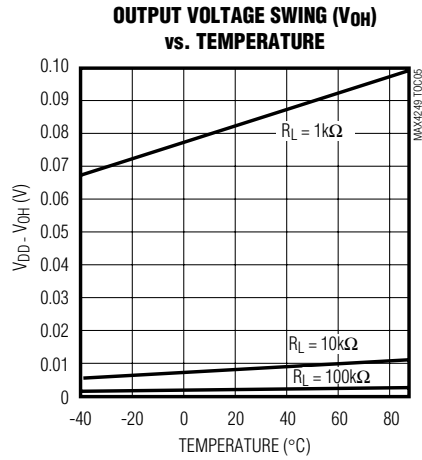
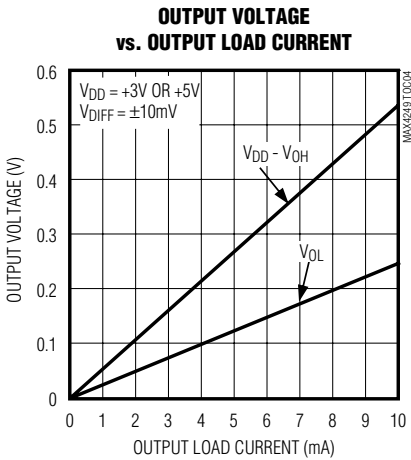
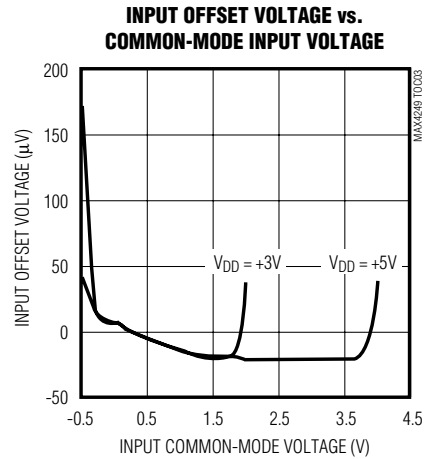
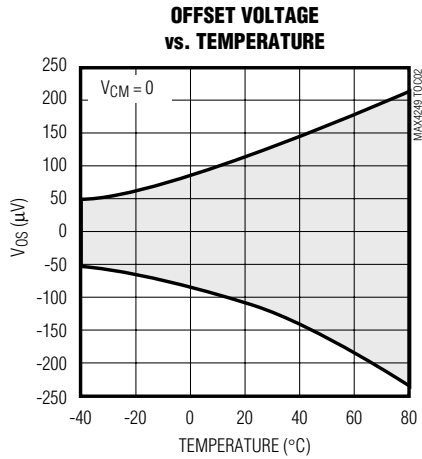
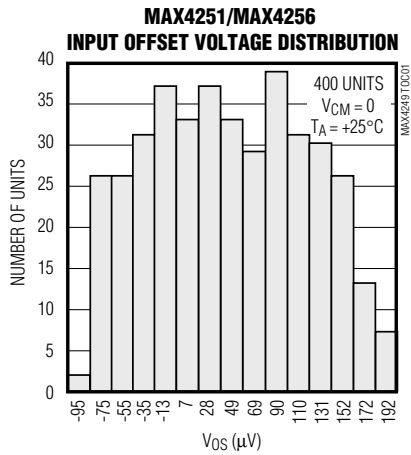

UCSP, Single-Supply, Low-Noise, Low-Distortion, Rail-to-Rail Op Amps

Typical Operating Characteristics (continued)

($V_{DD} = +5V$, $V_{SS} = 0$, $V_{CM} = V_{OUT} = V_{DD}/2$, input noise floor of test equipment = $10nV/\sqrt{Hz}$ for all distortion measurements, $T_A = +25^\circ C$, unless otherwise noted.)

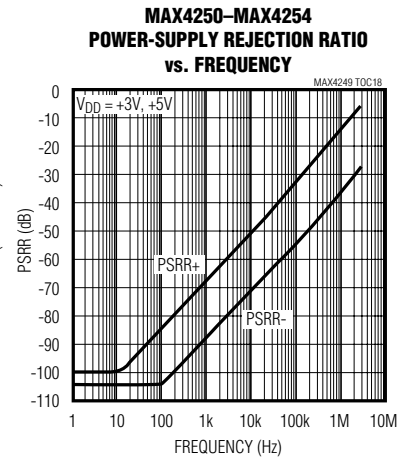
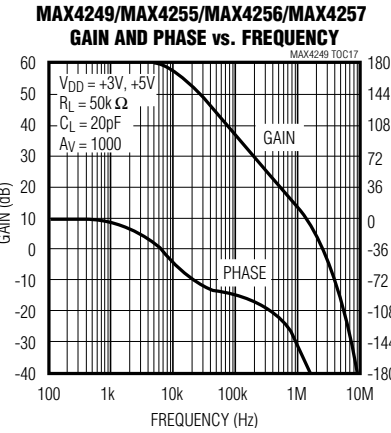
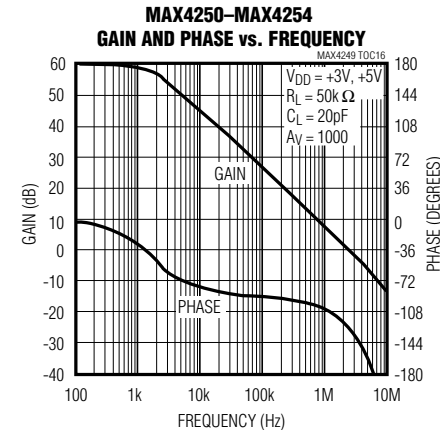
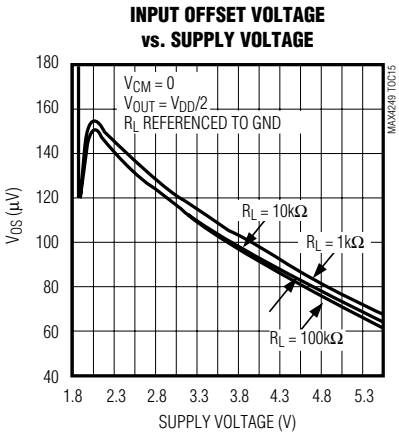
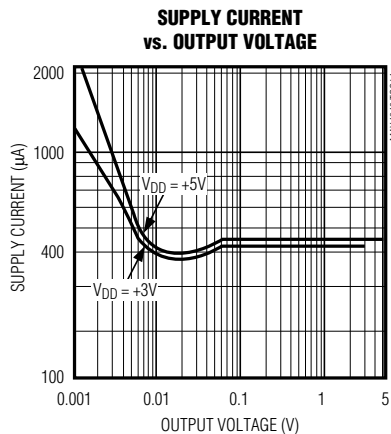
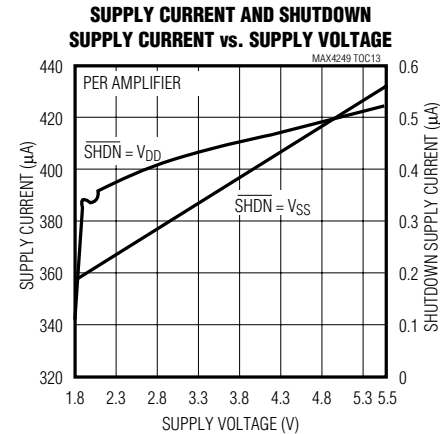
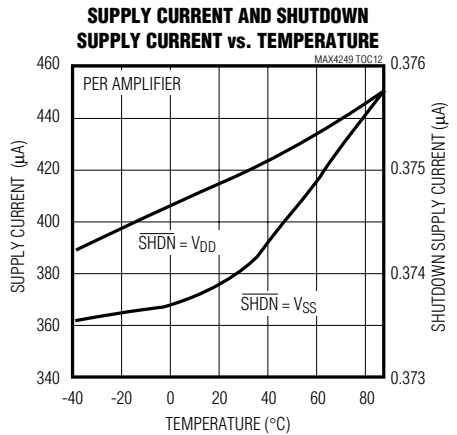
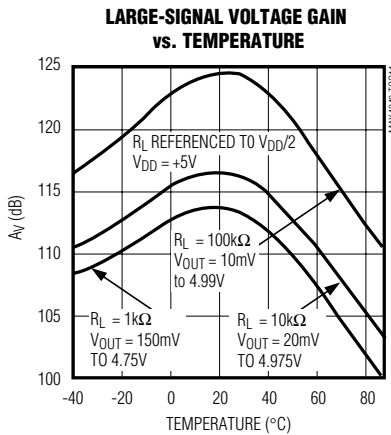
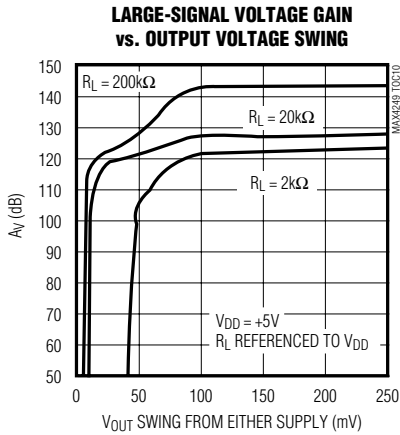

UCSP, Single-Supply, Low-Noise, Low-Distortion, Rail-to-Rail Op Amps

Typical Operating Characteristics (continued)

($V_{DD} = +5V$, $V_{SS} = 0$, $V_{CM} = V_{OUT} = V_{DD}/2$, input noise floor of test equipment = $10nV/\sqrt{Hz}$ for all distortion measurements, $T_A = +25^\circ C$, unless otherwise noted.)

MAX4249-MAX4257

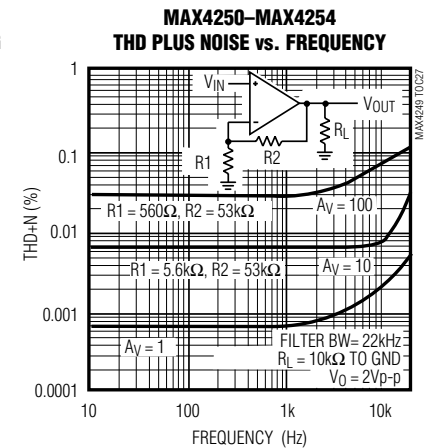
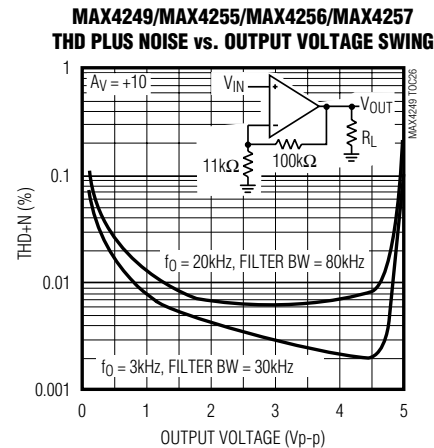
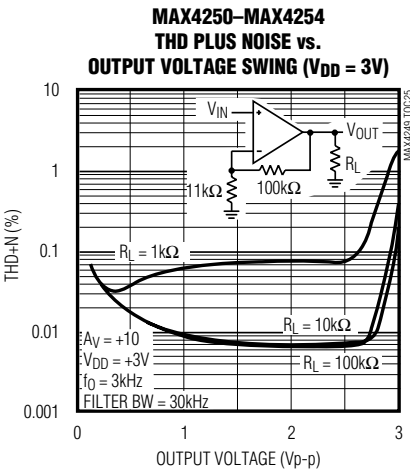
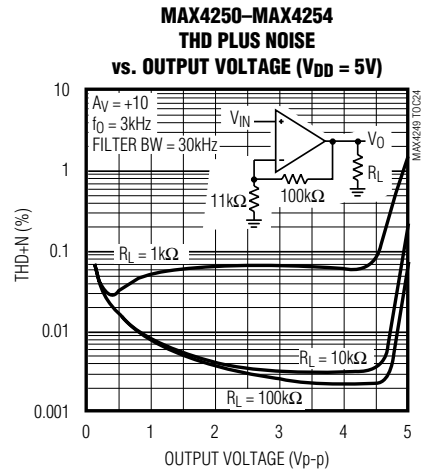
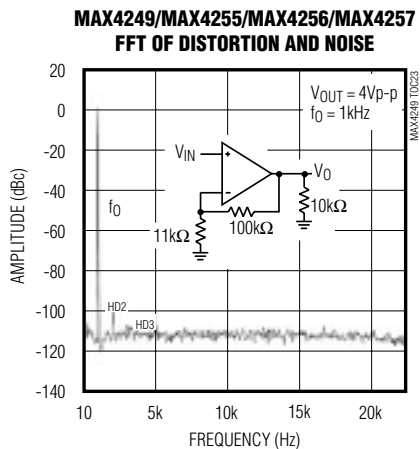
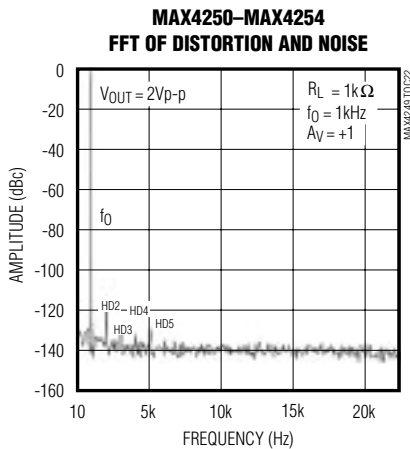
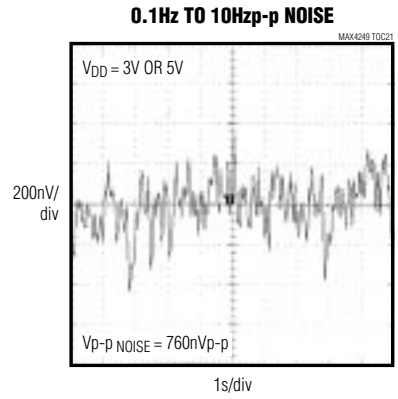
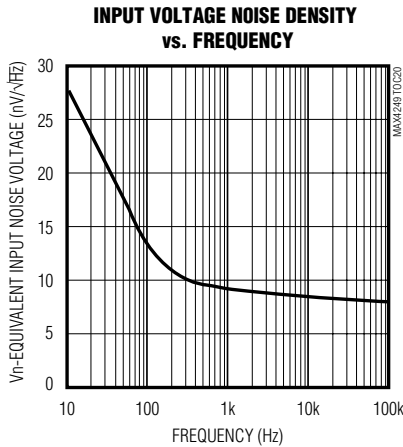
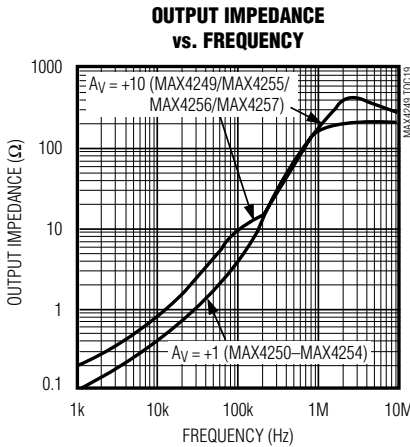

UCSP, Single-Supply, Low-Noise, Low-Distortion, Rail-to-Rail Op Amps

Typical Operating Characteristics (continued)

($V_{DD} = +5V$, $V_{SS} = 0$, $V_{CM} = V_{OUT} = V_{DD}/2$, input noise floor of test equipment = $10nV/\sqrt{Hz}$ for all distortion measurements, $T_A = +25^\circ C$, unless otherwise noted.)

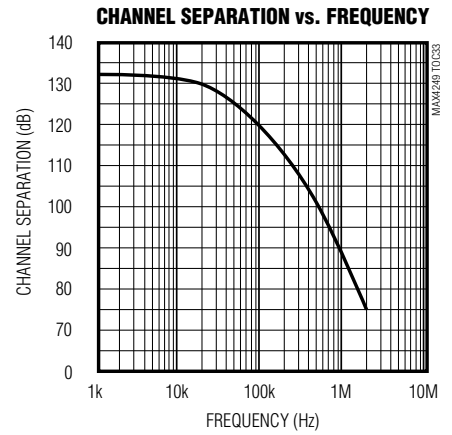
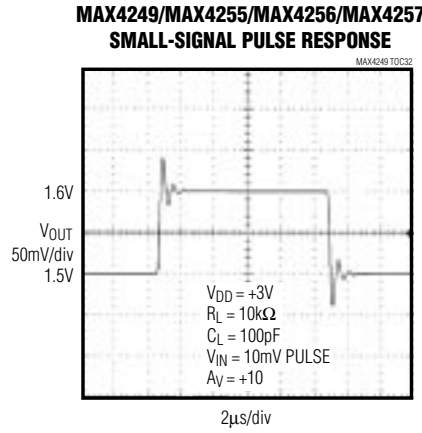
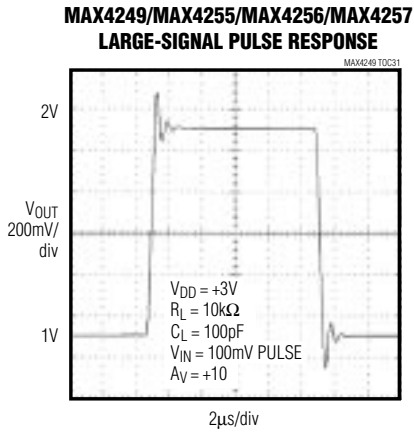
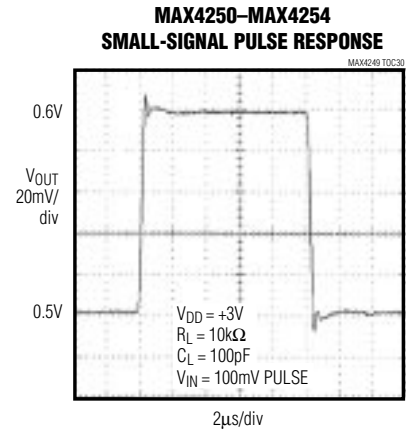
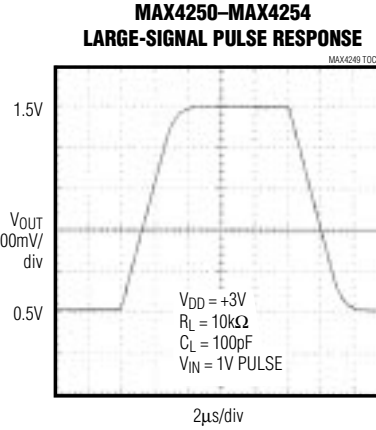
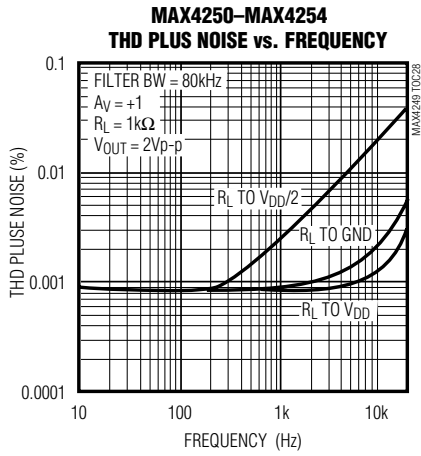

UCSP, Single-Supply, Low-Noise, Low-Distortion, Rail-to-Rail Op Amps

Pin Description

PIN								NAME	FUNCTION
MAX4250/ MAX4255	MAX4251/ MAX4256	MAX4252/ MAX4257	MAX4252	MAX4249/ MAX4253			MAX4254		
5 SOT23	8 SO/ μMAX	8 SO/ μMAX	8 UCSP	10 UCSP	10 μMAX	14 SO	14 SO		
1	6	1, 7	A1, A3	A1, C1	1, 9	1, 13	1, 7, 8, 14	OUT, OUTA, OUTB, OUTC, OUTD	Amplifier Output
2	4	4	C2	B4	4	4	11	V _{SS}	Negative Supply. Connect to ground for single-supply operation
3	3	3, 5	C1, C3	A3, C3	3, 5	3, 11	3, 5, 10, 12	IN+, INA+, INB+, INC+, IND+	Noninverting Amplifier Input
4	2	2, 6	B1, B3	A2, C2	2, 6	2, 12	2, 6, 9, 13	IN-, INA-, INB-, INC-, IND-	Inverting Amplifier Input
5	7	8	A2	B1	8	14	4	V _{DD}	Positive Supply
—	8	—	—	A4, C4	—	5, 9	—	$\overline{\text{SHDN}}$, SHDNA, SHDNB	Shutdown Input, Connect to V _{DD} or leave unconnected for normal operation (amplifier(s) enabled).
—	1, 5	—	—	—	—	5, 7, 8, 10	—	N.C.	No Connection. Not internally connected.
—	—	—	B2	B2, B3	—	—	—	—	Not populated with solder sphere

Detailed Description

The MAX4249–MAX4257 single-supply operational amplifiers feature ultra-low noise and distortion while consuming very little power. Their low distortion and low noise make them ideal for use as preamplifiers in wide dynamic-range applications, such as 16-bit analog-to-digital converters (see *Typical Operating Circuit*). Their high-input impedance and low noise are also useful for signal conditioning of high-impedance sources, such as piezoelectric transducers.

These devices have true rail-to-rail output operation, drive loads as low as 1kΩ while maintaining DC accuracy, and can drive capacitive loads up to 400pF without

oscillation. The input common-mode voltage range extends from V_{DD} - 1.1V to 200mV beyond the negative rail. The push/pull output stage maintains excellent DC characteristics, while delivering up to ±5mA of current.

The MAX4250–4254 are unity-gain stable, whereas, the MAX4249/MAX4255/MAX4256/MAX4257 have a higher slew rate and are stable for gains ≥ 10V/V. The MAX4249/MAX4251/MAX4253/MAX4256 feature a low-power shutdown mode, which reduces the supply current to 0.5μA and disables the outputs.

Low Distortion

Many factors can affect the noise and distortion that the device contributes to the input signal. The following

UCSP, Single-Supply, Low-Noise, Low-Distortion, Rail-to-Rail Op Amps

guidelines offer valuable information on the impact of design choices on Total Harmonic Distortion (THD).

Choosing proper feedback and gain resistor values for a particular application can be a very important factor in reducing THD. In general, the smaller the closed-loop gain, the smaller the THD generated, especially when driving heavy resistive loads. Large-value feedback resistors can significantly improve distortion. The THD of the part normally increases at approximately 20dB per decade, as a function of frequency. Operating the device near or above the full-power bandwidth significantly degrades distortion.

Referencing the load to either supply also improves the part's distortion performance, because only one of the MOSFETs of the push/pull output stage drives the output. Referencing the load to mid-supply increases the part's distortion for a given load and feedback setting. (See the Total Harmonic Distortion vs. Frequency graph in the *Typical Operating Characteristics*.)

For gains $\geq 10V/V$, the decompensated devices MAX4249/MAX4255/MAX4256/MAX4257 deliver the best distortion performance, since they have a higher slew rate and provide a higher amount of loop gain for a given closed-loop gain setting. Capacitive loads below 400pF, do not significantly affect distortion results. Distortion performance remains relatively constant over supply voltages.

Low Noise

The amplifier's input-referred noise voltage density is dominated by flicker noise at lower frequencies, and by thermal noise at higher frequencies. Because the thermal noise contribution is affected by the parallel combination of the feedback resistive network ($R_F \parallel R_G$, Figure 1), these resistors should be reduced in cases where the system bandwidth is large and thermal noise is dominant. This noise contribution factor decreases, however, with increasing gain settings.

For example, the input noise voltage density of the circuit with $R_F = 100k\Omega$, $R_G = 11k\Omega$ ($A_V = 10V/V$) is $e_n = 15nV/\sqrt{Hz}$, e_n can be reduced to $9nV/\sqrt{Hz}$ by choosing $R_F = 10k\Omega$, $R_G = 1.1k\Omega$ ($A_V = 10V/V$), at the expense of greater current consumption and potentially higher distortion. For a gain of $100V/V$ with $R_F = 100k\Omega$, $R_G = 1.1k\Omega$, the e_n is low ($9nV/\sqrt{Hz}$).

Using a Feed-Forward Compensation Capacitor, C_Z

The amplifier's input capacitance is 11pF. If the resistance seen by the inverting input is large (feedback network), this can introduce a pole within the amplifier's bandwidth, resulting in reduced phase margin.

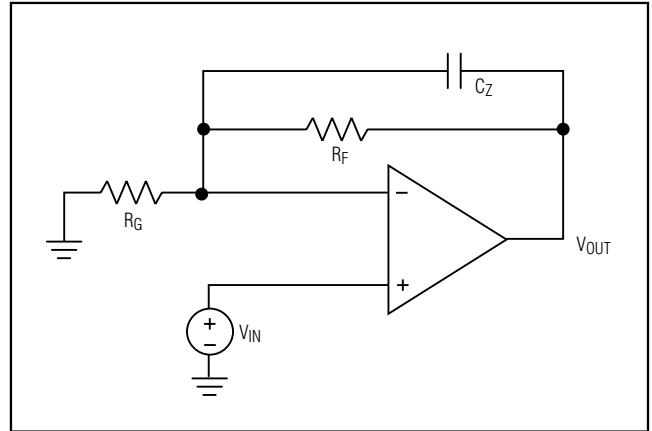

Figure 1. Adding Feed-Forward Compensation

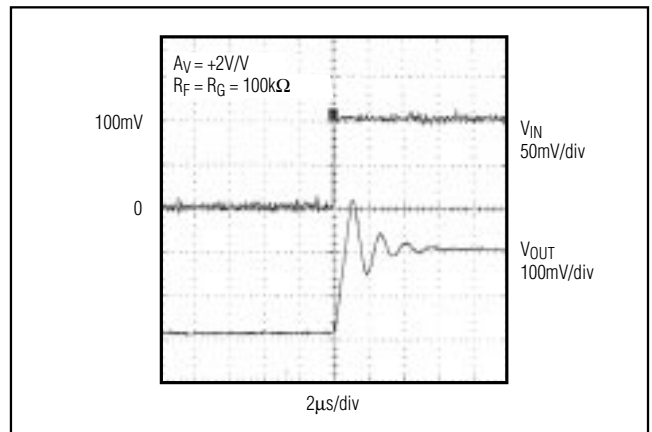

Figure 2a. Pulse Response with No Feed-Forward Compensation

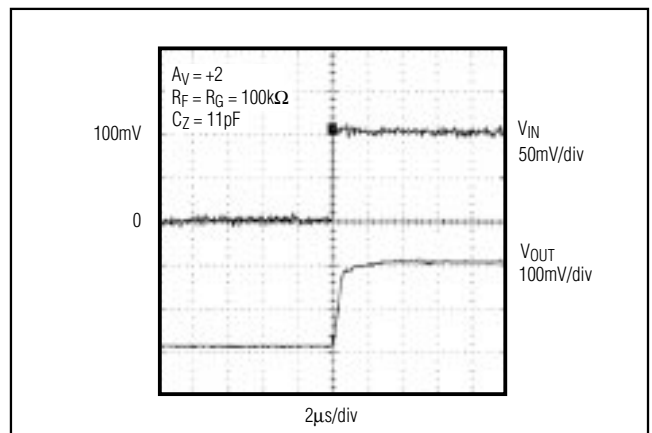

Figure 2b. Pulse Response with 10pF Feed-Forward Compensation

UCSP, Single-Supply, Low-Noise, Low-Distortion, Rail-to-Rail Op Amps

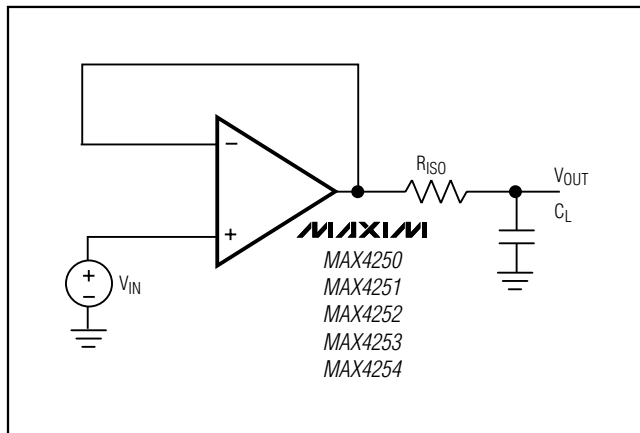

Figure 3. Overdriven Input Showing No Phase Reversal

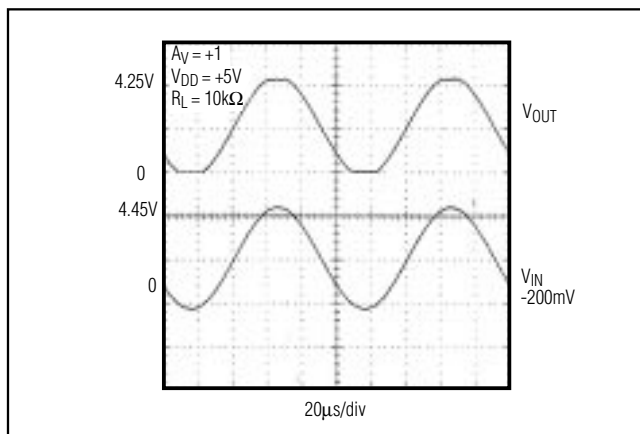

Figure 4. Rail-to-Rail Output Operation

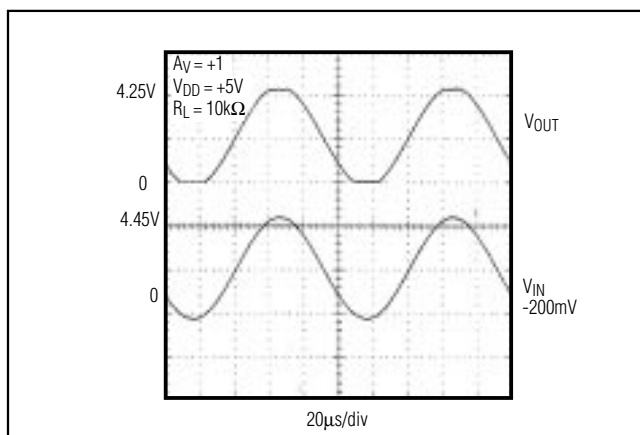

Figure 5. Capacitive-Load Driving Circuit

Compensate the reduced phase margin by introducing a feed-forward capacitor (C_z) between the inverting input and the output (Figure 1). This effectively cancels the pole from the inverting input of the amplifier. Choose the value of C_z as follows:

$$C_z = 11 \times (R_F / R_G) \text{ [pF]}$$

In the unity-gain stable MAX4250–MAX4254, the use of a proper C_z is most important for $A_V = +2V/V$, and $A_V = -1V/V$. In the decompensated MAX4249/MAX4255/MAX4256/MAX4257, C_z is most important for $A_V = +10V/V$. Figures 2a and 2b show transient response both with and without C_z .

Using a slightly smaller C_z than suggested by the formula above achieves a higher bandwidth at the expense of reduced phase and gain margin. As a general guideline, consider using C_z for cases where $R_G \parallel R_F$ is greater than $20k\Omega$ (MAX4250–MAX4254) or greater than $5k\Omega$ (MAX4249/MAX4255/MAX4256/MAX4257).

Applications Information

The MAX4249–MAX4257 combine good driving capability with ground-sensing input and rail-to-rail output operation. With their low distortion, low noise and low-power consumption, these devices are ideal for use in portable instrumentation systems and other low-power, noise-sensitive applications.

Ground-Sensing and Rail-to-Rail Outputs

The common-mode input range of these devices extends below ground, and offers excellent common-mode rejection. These devices are guaranteed not to undergo phase reversal when the input is overdriven (Figure 3).

Figure 4 showcases the true rail-to-rail output operation of the amplifier, configured with $A_V = 10V/V$. The output swings to within 8mV of the supplies with a $10k\Omega$ load, making the devices ideal in low-supply-voltage applications.

Output Loading and Stability

Even with their low quiescent current of $400\mu A$, these amplifiers can drive $1k\Omega$ loads while maintaining excellent DC accuracy. Stability while driving heavy capacitive loads is another key feature.

These devices maintain stability while driving loads up to $400pF$. To drive higher capacitive loads, place a small isolation resistor in series between the output of the amplifier and the capacitive load (Figure 5). This resistor improves the amplifier's phase margin by isolating the capacitor from the op amp's output.

UCSP, Single-Supply, Low-Noise, Low-Distortion, Rail-to-Rail Op Amps

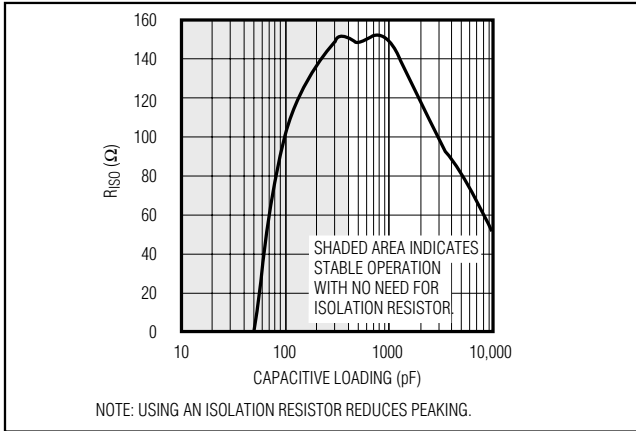

Figure 6. Isolation Resistance vs. Capacitive Loading to Minimize Peaking (<2dB)

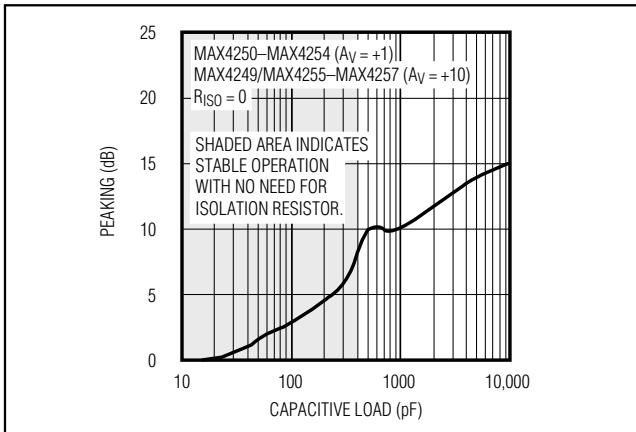

Figure 7. Peaking vs. Capacitive Load

Reference Figure 6 to select a resistance value that will ensure a load capacitance that limits peaking to <2dB (25%). For example, if the capacitive load is 1000pF, the corresponding isolation resistor is 150Ω. Figure 7 shows that peaking occurs without the isolation resistor. Figure 8 shows the unity-gain bandwidth vs. capacitive load for the MAX4250-MAX4254.

Power Supplies and Layout

The MAX4249-MAX4257 operate from a single +2.4V to +5.5V power supply or from dual supplies of ±1.20V to ±2.75V. For single-supply operation, bypass the power supply with a 0.1μF ceramic capacitor placed close to the VDD pin. If operating from dual supplies, bypass each supply to ground.

Good layout improves performance by decreasing the amount of stray capacitance and noise at the op amp's inputs and output. To decrease stray capacitance, min-

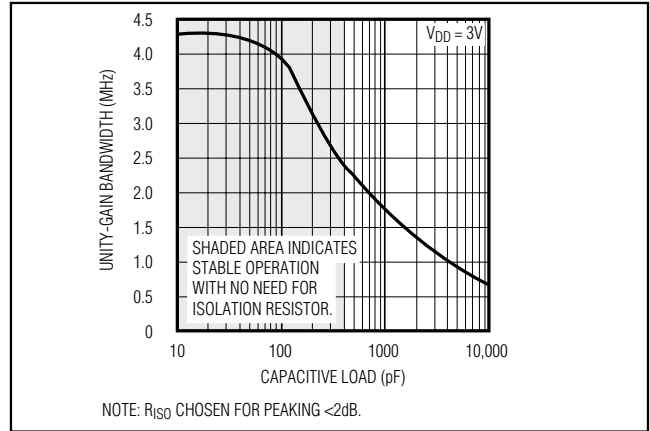

Figure 8. MAX4250-4254 Unity-Gain Bandwidth vs. Capacitive Load

imize PC board trace lengths and resistor leads, and place external components close to the op amp's pins.

UCSP Package Consideration

For general UCSP package information and PC layout considerations, please refer to the Maxim Application Note (Wafer-Level Ultra-Chip-Board-Scale-Package).

UCSP Reliability

The chip-scale package (UCSP) represents a unique packaging form factor that may not perform equally to a packaged product through traditional mechanical reliability tests. CSP reliability is integrally linked to the user's assembly methods, circuit board material, and usage environment. The user should closely review these areas when considering use of a CSP package. Performance through Operating Life Test and Moisture Resistance remains uncompromised as it is primarily determined by the wafer-fabrication process. Mechanical stress performance is a greater consideration for a CSP package. CSPs are attached through direct solder contact to the user's PC board, foregoing the inherent stress relief of a packaged product lead frame. Solder joint contact integrity must be considered. Table 1 shows the testing done to characterize the CSP reliability performance. In conclusion, the UCSP is capable of performing reliably through environmental stresses as indicated by the results in the table. Additional usage data and recommendations are detailed in the UCSP application note, which can be found on Maxim's website at www.maxim-ic.com.

UCSP, Single-Supply, Low-Noise, Low-Distortion, Rail-to-Rail Op Amps

Typical Operating Circuit

MAX4249-MAX4257

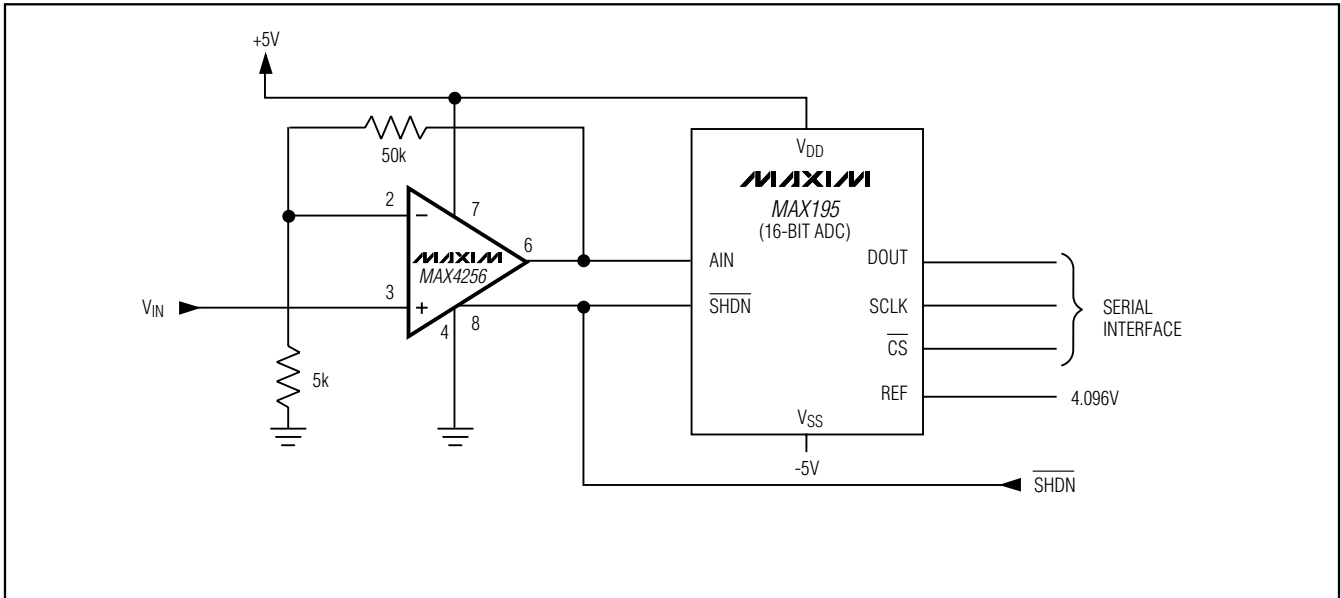

Table 1. Reliability Test Data

TEST	CONDITIONS	DURATION	NO. OF FAILURES PER SAMPLE SIZE
Temperature Cycle	-35°C to +85°C, -40°C to +100°C	150 cycles, 900 cycles	0/10, 0/200
Operating Life	$T_A = +70^\circ\text{C}$	240h	0/10
Moisture Resistance	-20°C to +60°C, 90% RH	240h	0/10
Low-Temperature Storage	-20°C	240h	0/10
Low-Temperature Operational	-10°C	24h	0/10
Solderability	8h steam age	—	0/15
ESD	$\pm 2000\text{V}$, Human Body Model	—	0/5
High-Temperature Operating Life	$T_J = +150^\circ\text{C}$	168h	0/45

UCSP, Single-Supply, Low-Noise, Low-Distortion, Rail-to-Rail Op Amps

Selector Guide

PART	GAIN BANDWIDTH (MHz)	MINIMUM STABLE GAIN (V/V)	NO. OF AMPLIFIERS PER PACKAGE	SHUTDOWN MODE	PIN-PACKAGE
MAX4249	22	10	2	Yes	10-pin μ MAX, 14-pin SO
MAX4250	3	1	1	—	5-pin SOT23
MAX4251	3	1	1	Yes	8-pin μ MAX/SO
MAX4252	3	1	2	—	8-pin μ MAX/SO, 8-pin UCSP
MAX4253	3	1	2	Yes	10-pin μ MAX, 14-pin SO, 10-pin UCSP
MAX4254	3	1	4	—	14-pin SO
MAX4255	22	10	1	—	5-pin SOT23
MAX4256	22	10	1	Yes	8-pin μ MAX/SO
MAX4257	22	10	2	—	8-pin μ MAX/SO

Ordering Information (continued)

PART	TEMP. RANGE	PIN/BUMP-PACKAGE	TOP MARK
MAX4251 ESA	-40°C to +85°C	8 SO	—
MAX4251EUA	-40°C to +85°C	8 μ MAX	—
MAX4252 ESA	-40°C to +85°C	8 SO	—
MAX4252EBA-T*	-40°C to +85°C	8 UCSP	AAO
MAX4252EUA	-40°C to +85°C	8 μ MAX	—
MAX4253 EUB	-40°C to +85°C	10 μ MAX	—
MAX4253EBB-T*	-40°C to +85°C	10 UCSP	AAK
MAX4253ESD	-40°C to +85°C	14 SO	—
MAX4254 ESD	-40°C to +85°C	14 SO	—
MAX4255 EUK-T	-40°C to +85°C	5 SOT23-5	ACCJ
MAX4256 ESA	-40°C to +85°C	8 SO	—
MAX4256EUA	-40°C to +85°C	8 μ MAX	—
MAX4257 ESA	-40°C to +85°C	8 SO	—
MAX4257EUA	-40°C to +85°C	8 μ MAX	—

*UCSP reliability is integrally linked to the user's assembly methods, circuit board material, and environment. Refer to the UCSP Reliability Notice in the UCSP Reliability section of this data sheet for more information.

Chip Information

TRANSISTOR COUNTS:

MAX4250/MAX4251/MAX4255/MAX4256: 170

MAX4249/MAX4252/MAX4253/MAX4257: 340

MAX4254: 680

UCSP, Single-Supply, Low-Noise, Low-Distortion, Rail-to-Rail Op Amps

Pin Configurations (continued)

MAX4249-MAX4257

TOP VIEW

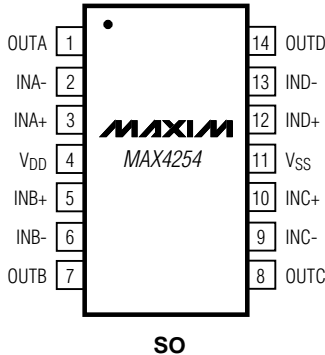
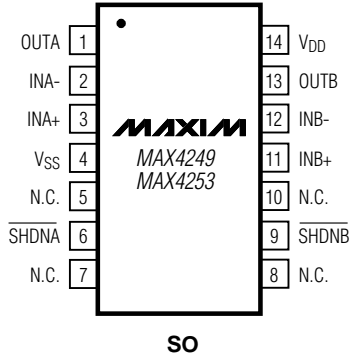
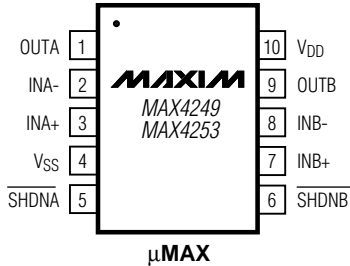
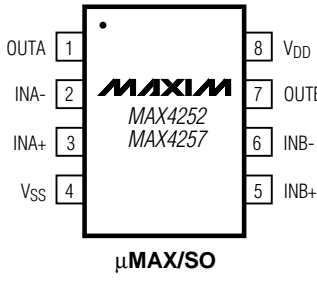
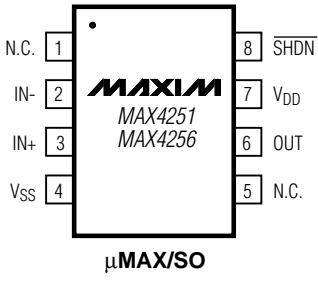
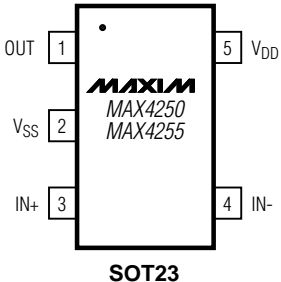

UCSP, Single-Supply, Low-Noise, Low-Distortion, Rail-to-Rail Op Amps

Package Information

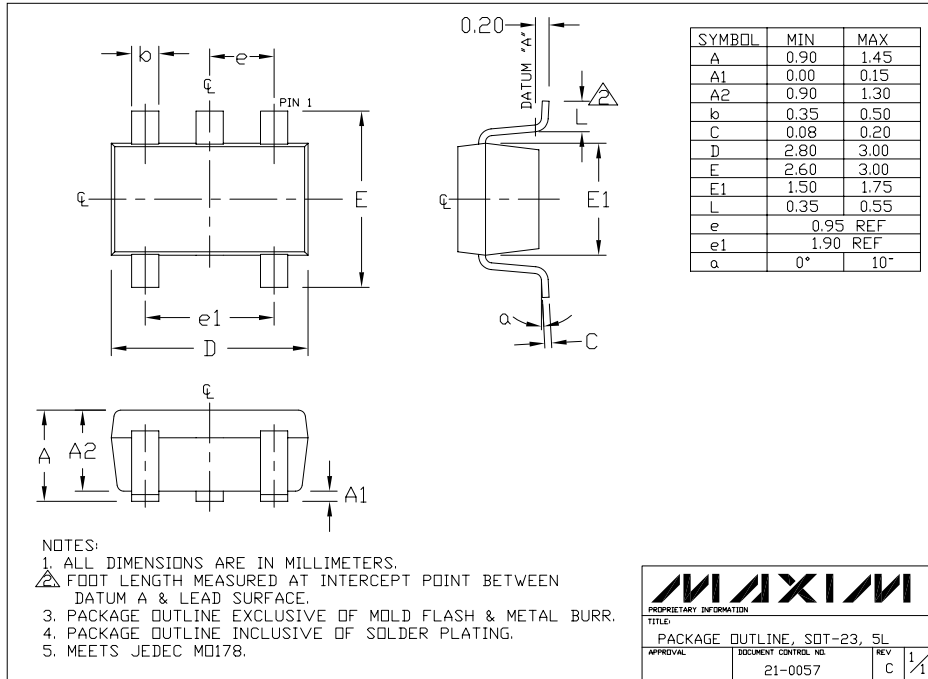

SOT-23, 5L

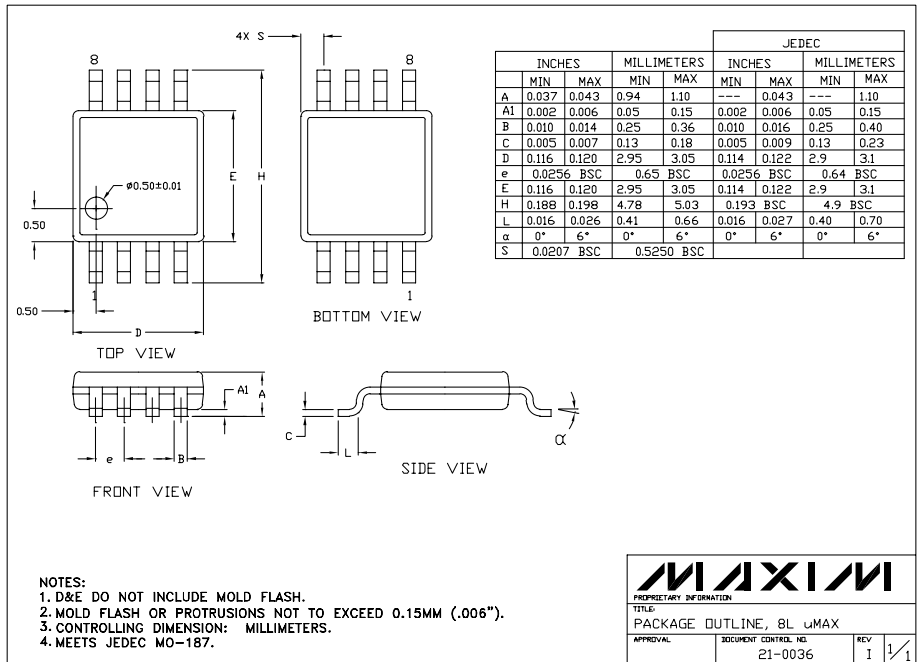

8L uMAX

UCSP, Single-Supply, Low-Noise, Low-Distortion, Rail-to-Rail Op Amps

Package Information (continued)

MAX4249-MAX4257

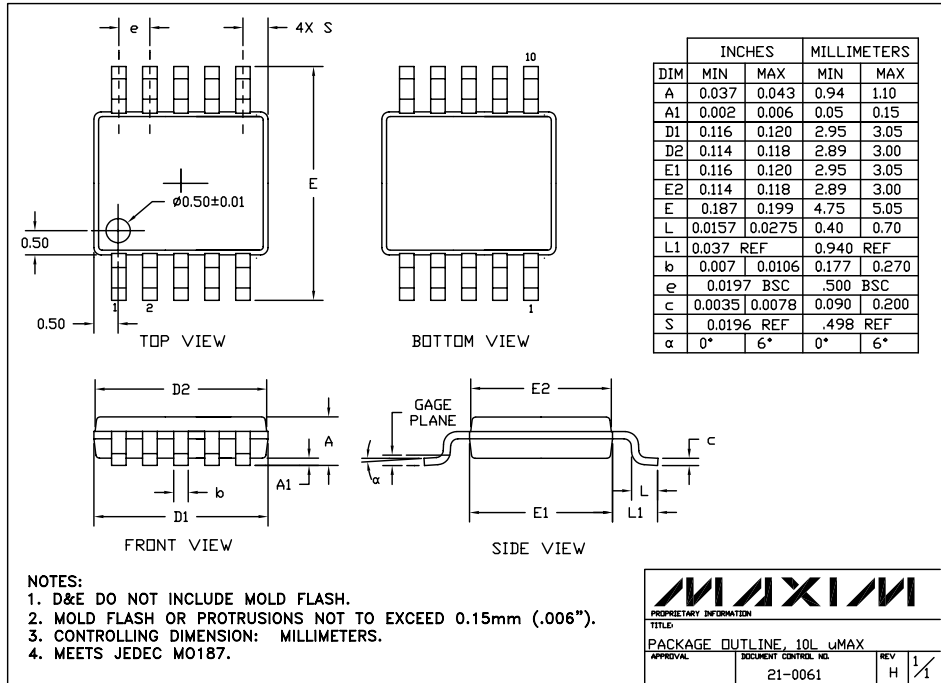

10LUMAX.EPS

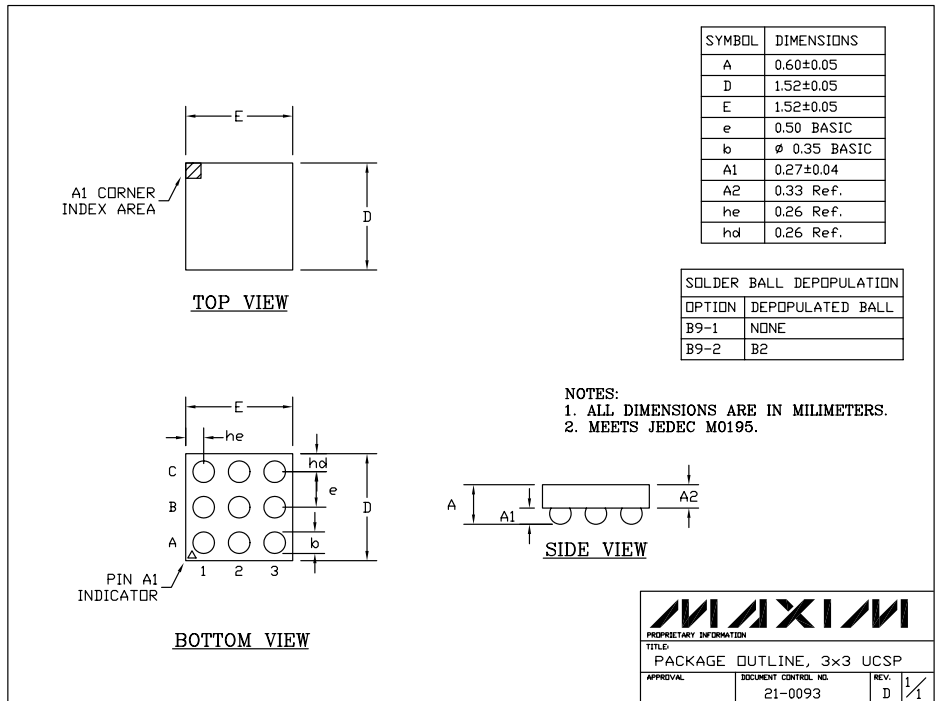

9LUCSP_3x3.EPS

UCSP, Single-Supply, Low-Noise, Low-Distortion, Rail-to-Rail Op Amps

Package Information (continued)

SOIC16

	INCHES		MILLIMETERS	
	MIN	MAX	MIN	MAX
A	0.053	0.069	1.35	1.75
A1	0.004	0.010	0.10	0.25
B	0.014	0.019	0.35	0.49
C	0.007	0.010	0.19	0.25
e	0.050		1.27	
E	0.150	0.157	3.80	4.00
H	0.228	0.244	5.80	6.20
h	0.010	0.020	0.25	0.50
L	0.016	0.050	0.40	1.27

	INCHES		MILLIMETERS		N	MS012
	MIN	MAX	MIN	MAX		
D	0.189	0.197	4.80	5.00	8	A
D	0.337	0.344	8.55	8.75	14	B
D	0.386	0.394	9.80	10.00	16	C

NOTES:
 1. D&E DO NOT INCLUDE MOLD FLASH
 2. MOLD FLASH OR PROTRUSIONS NOT TO EXCEED .15mm (.006")
 3. LEADS TO BE COPLANAR WITHIN .102mm (.004")
 4. CONTROLLING DIMENSION: MILLIMETER
 5. MEETS JEDEC MS012-XX AS SHOWN IN ABOVE TABLE
 6. N = NUMBER OF PINS

MAXIM 21-0041 A
120 SAN GABRIEL DR. SAN ANTONIO, CA 78248 FAX (409) 737-7794 PROPRIETARY INFORMATION
 PACKAGE FAMILY OUTLINE: SOIC .150" TITLE: 1/1 DOCUMENT CONTROL NUMBER REV

UCSP, Single-Supply, Low-Noise, Low-Distortion, Rail-to-Rail Op Amps

Package Information (continued)

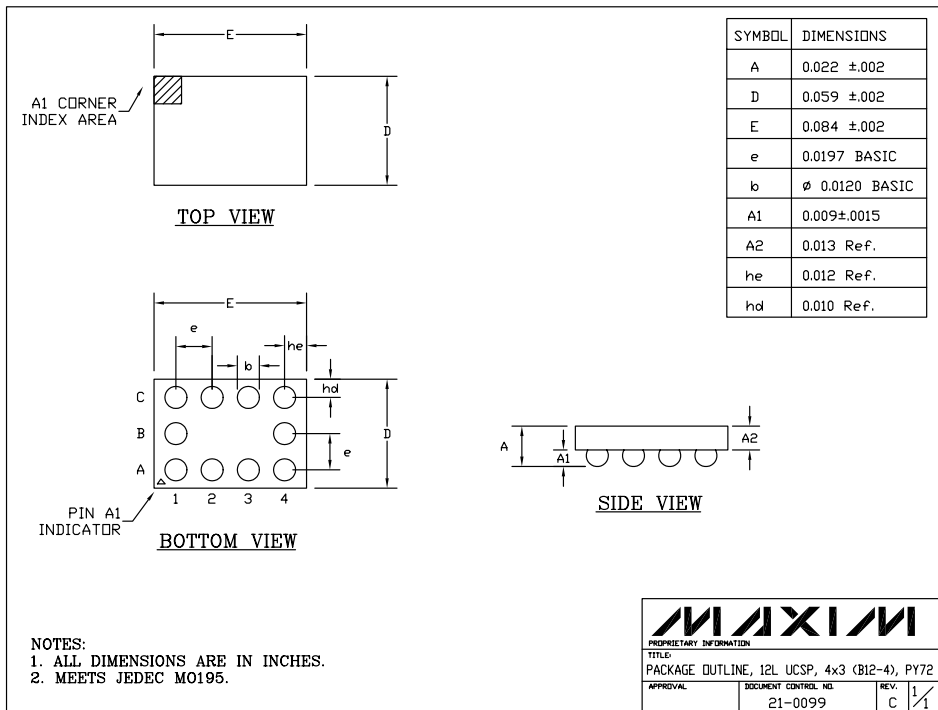

MAX4249-MAX4257

Maxim cannot assume responsibility for use of any circuitry other than circuitry entirely embodied in a Maxim product. No circuit patent licenses are implied. Maxim reserves the right to change the circuitry and specifications without notice at any time.

Maxim Integrated Products, 120 San Gabriel Drive, Sunnyvale, CA 94086 408-737-7600 19