

### FEATURES

- Precision 2.5 V to 5 V power supply monitor
- 7 reset threshold options: 2.19 V to 4.63 V
- 140 ms (min) reset timeout
- Watchdog timer with 1.6s timeout (ADM823, ADM824)
- Manual reset input (ADM823, ADM825)
- Push-pull output stages:
  - $\overline{\text{RESET}}$  (ADM823)
  - $\overline{\text{RESET}}, \text{RESET}$  (ADM824/ADM825)
- Low power consumption (3  $\mu\text{A}$ )
- Guaranteed reset output valid to  $V_{\text{CC}} = 1 \text{ V}$
- Power supply glitch immunity
- Specified over automotive temperature range
- 5-lead SC70 and SOT-23 packages

### APPLICATIONS

- Microprocessor systems
- Computers
- Controllers
- Intelligent instruments
- Portable equipment

### GENERAL DESCRIPTION

The ADM823/ADM824/ADM825 are supervisory circuits which monitor power supply voltage levels and code execution integrity in microprocessor-based systems. As well as providing power on reset signals, an on-chip watchdog timer can reset the microprocessor if it fails to strobe within a preset timeout period. A reset signal can also be asserted by means of an external push-button, through a manual reset input. The three parts feature different combinations of watchdog input, manual reset input and output stage configuration, as shown in Table 1.

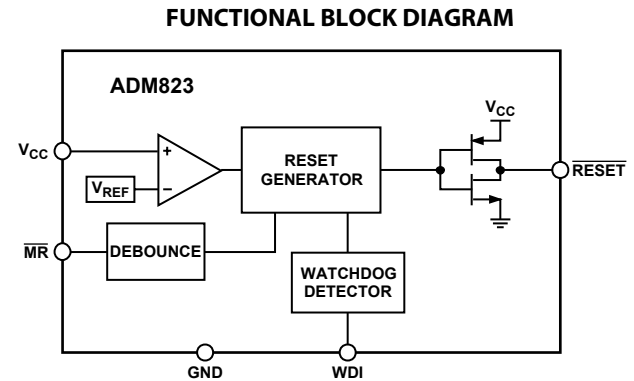

Figure 1.

Each part is available in a choice of seven reset threshold options ranging from 2.19 V to 4.63 V. The reset and watchdog timeout periods are fixed at 140 ms (min) and 1.6s (typ), respectively.

The ADM823/ADM824/ADM825 are available in 5-lead SC70 and SOT-23 packages and typically consume only 3  $\mu\text{A}$ , making them suitable for use in low power portable applications.

Table 1. Selection Table

Part No.	Watchdog Timer	Manual Reset	Output Stage	
			$\overline{\text{RESET}}$	RESET
ADM823	Yes	Yes	Push-Pull	–
ADM824	Yes	–	Push-Pull	Push-Pull
ADM825	–	Yes	Push-Pull	Push-Pull

### Rev.PrB

Information furnished by Analog Devices is believed to be accurate and reliable. However, no responsibility is assumed by Analog Devices for its use, nor for any infringements of patents or other rights of third parties that may result from its use. Specifications subject to change without notice. No license is granted by implication or otherwise under any patent or patent rights of Analog Devices. Trademarks and registered trademarks are the property of their respective owners.

**TABLE OF CONTENTS**

Specifications.....	3	Typical Performance Characteristics .....	7
Absolute Maximum Ratings.....	5	OUTLINE DIMENSIONS .....	9
ESD Caution.....	5	Ordering Guides.....	10
Pin Configurations and Function Descriptions .....	6		

## SPECIFICATIONS

$V_{CC} = 4.75\text{ V to }5.5\text{ V}$  for ADM82\_L,  $V_{CC} = 4.5\text{ V to }5.5\text{ V}$  for ADM82\_M,  $V_{CC} = 3.15\text{ V to }3.6\text{ V}$  for ADM82\_T,  
 $V_{CC} = 3\text{ V to }3.6\text{ V}$  for ADM82\_S,  $V_{CC} = 2.7\text{ V to }3.6\text{ V}$  for ADM82\_R,  $V_{CC} = 2.38\text{ V to }2.75\text{ V}$  for ADM82\_Z,  
 $V_{CC} = 2.25\text{ V to }2.75\text{ V}$  for ADM82\_Y,  $T_A = T_{MIN}$  to  $T_{MAX}$ , unless otherwise noted

**Table 2.**

Parameter	Min	Typ	Max	Unit	Test Conditions/Comments
<b>SUPPLY</b>					
$V_{CC}$ Operating Voltage Range	1		5.5	V	$T_A = 0^\circ\text{C to }+70^\circ\text{C}$
Supply Current	1.2	10	24	V	$T_A = T_{MIN}$ to $T_{MAX}$
		5	12	$\mu\text{A}$	WDI and $\overline{\text{MR}}$ unconnected ADM82_L/M
				$\mu\text{A}$	WDI and $\overline{\text{MR}}$ unconnected ADM82_T/S/R/Z/Y
<b>RESET THRESHOLD VOLTAGE</b>					
ADM82_L	4.56	4.63	4.70	V	$T_A = 25^\circ\text{C}$
	4.50		4.75	V	$T_A = T_{MIN}$ to $T_{MAX}$
ADM82_M	4.31	4.38	4.45	V	$T_A = 25^\circ\text{C}$
	4.25		4.50	V	$T_A = T_{MIN}$ to $T_{MAX}$
ADM82_T	3.04	3.08	3.11	V	$T_A = 25^\circ\text{C}$
	3.00		3.15	V	$T_A = T_{MIN}$ to $T_{MAX}$
ADM82_S	2.89	2.93	2.96	V	$T_A = 25^\circ\text{C}$
	2.85		3.00	V	$T_A = T_{MIN}$ to $T_{MAX}$
ADM82_R	2.59	2.63	2.66	V	$T_A = 25^\circ\text{C}$
	2.55		2.70	V	$T_A = T_{MIN}$ to $T_{MAX}$
ADM82_Z (SC70 only)	2.28	2.32	2.35	V	$T_A = 25^\circ\text{C}$
	2.25		2.38	V	$T_A = T_{MIN}$ to $T_{MAX}$
ADM82_Y (SC70 only)	2.16	2.19	2.22	V	$T_A = 25^\circ\text{C}$
	2.13		2.25	V	$T_A = T_{MIN}$ to $T_{MAX}$
RESET THRESHOLD TEMPERATURE COEFFICIENT		40		ppm/ $^\circ\text{C}$	
RESET THRESHOLD HYSTERESIS		10		mV	ADM82_L/M
		5		mV	ADM82_T/S/R/Z/Y
RESET TIMEOUT PERIOD	140	200	280	ms	
$V_{CC}$ TO RESET DELAY		40		$\mu\text{s}$	$V_{TH} - V_{CC} = 100\text{ mV}$
RESET Output Voltage			0.4	V	$V_{CC} = V_{TH}$ min, $I_{SINK} = 3.2\text{ mA}$ , ADM82_L/M
			0.3	V	$V_{CC} = V_{TH}$ min, $I_{SINK} = 1.2\text{ mA}$ , ADM82_T/S/R/Z/Y
			0.3	V	$T_A = 0^\circ\text{C to }70^\circ\text{C}$ , $V_{CC} = 1\text{ V}$ , $V_{CC}$ falling, $I_{SINK} = 50\text{ }\mu\text{A}$
	$V_{CC} - 1.5$			V	$V_{CC} = V_{TH}$ max, $I_{SOURCE} = 120\text{ }\mu\text{A}$ , ADM82_L/M
	$0.8 \times V_{CC}$			V	$V_{CC} = V_{TH}$ max, $I_{SOURCE} = 30\text{ }\mu\text{A}$ , ADM82_T/S/R/Z/Y
RESET Output Short Circuit Current			800	$\mu\text{A}$	RESET = 0 V, $V_{CC} = 5.5\text{ V}$ , ADM82_L/M
			400	$\mu\text{A}$	RESET = 0 V, $V_{CC} = 5.5\text{ V}$ , ADM82_T/S/R/Z/Y
RESET Output Voltage			0.4	V	$V_{CC} = V_{TH}$ max, $I_{SINK} = 3.2\text{ mA}$ , ADM824L/M, ADM825L/M
			0.3	V	$V_{CC} = V_{TH}$ max, $I_{SINK} = 1.2\text{ mA}$ , ADM824T/S/R/Z/Y, ADM825T/S/R/Z/Y
	$0.8 \times V_{CC}$			V	$V_{CC} > = 1.8\text{ V}$ , $I_{SOURCE} = 150\text{ }\mu\text{A}$

Parameter	Min	Typ	Max	Unit	Test Conditions/Comments
WATCHDOG INPUT (ADM823, ADM824)					
Watchdog Timeout Period	1.12	1.6	2.40	s	$V_{IL} = 0.4 V, V_{IH} = 0.8 \times V_{CC}$ ,
WDI Pulse Width	50			ns	
WDI Input Threshold					$V_{WDI} = V_{CC}$ , time average $V_{WDI} = 0$ , time average
$V_{IL}$			$0.3 \times V_{CC}$	V	
$V_{IH}$	$0.7 \times V_{CC}$			V	
WDI Input Current		120	160	$\mu A$	
	-20	-15		$\mu A$	
MANUAL RESET INPUT (ADM823, ADM825)					
$\overline{MR}$ Input Threshold			$0.3 \times V_{CC}$	V	
	$0.7 \times V_{CC}$			V	
$\overline{MR}$ Input Pulse Width	1			$\mu s$	
$\overline{MR}$ Glitch Rejection		100		ns	
$\overline{MR}$ Pull-up Resistance	35	52	75	$k\Omega$	
$\overline{MR}$ to Reset Delay		500		ns	

## ABSOLUTE MAXIMUM RATINGS

$T_A = 25^\circ\text{C}$ , unless otherwise noted.

**Table 3.**

Parameter	Rating
$V_{CC}$	-0.3 V to +6 V
Output Current (RESET, $\overline{\text{RESET}}$ )	20 mA
Operating Temperature Range	-40°C to +125°C
Storage Temperature Range	-65°C to +150°C
$\theta_{JA}$ Thermal Impedance	
SC70	146°C/W
SOT-23	270°C/W
Lead Temperature	
Soldering (10 sec)	300°C
Vapor Phase (60 sec)	215°C
Infrared (15 sec)	220°C

Stresses above those listed under Absolute Maximum Ratings may cause permanent damage to the device. This is a stress rating only and functional operation of the device at these or any other conditions above those indicated in the operational section of this specification is not implied. Exposure to absolute maximum rating conditions for extended periods may affect device reliability.

### ESD CAUTION

ESD (electrostatic discharge) sensitive device. Electrostatic charges as high as 4000 V readily accumulate on the human body and test equipment and can discharge without detection. Although this product features proprietary ESD protection circuitry, permanent damage may occur on devices subjected to high energy electrostatic discharges. Therefore, proper ESD precautions are recommended to avoid performance degradation or loss of functionality.



**PIN CONFIGURATIONS AND FUNCTION DESCRIPTIONS**

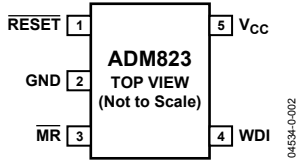

Figure 2. ADM823 Pin Configuration

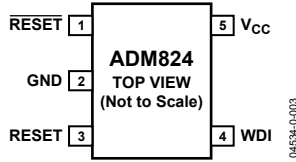

Figure 3. ADM824 Pin Configuration

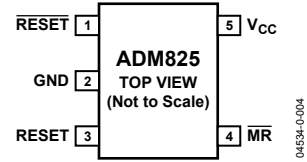

Figure 4. ADM825 Pin Configuration

**Table 4. Pin Function Descriptions**

Pin. No.	Mnemonic	Description
1	RESET	Push-Pull Active-Low Reset Output. Asserted whenever $V_{CC}$ is below the reset threshold, $V_{TH}$ .
2	GND	Ground.
3	MR (ADM823)	Manual Reset Input. This is an active-low input which, when forced low for at least 1 $\mu$ s, generates a reset. It features a 52 k $\Omega$ internal pull-up.
4	RESET (ADM824/ADM825)	Active-High, Push-Pull Reset Output.
	WDI (ADM823/ADM824)	Watchdog Input. Generates a reset if the voltage on the pin remains low or high for the duration of the watchdog timeout. The timer is cleared if a logic transition occurs on this pin or if a reset is generated.
5	MR (ADM825)	Manual Reset Input.
	$V_{CC}$	Power Supply Voltage Being Monitored.

### TYPICAL PERFORMANCE CHARACTERISTICS

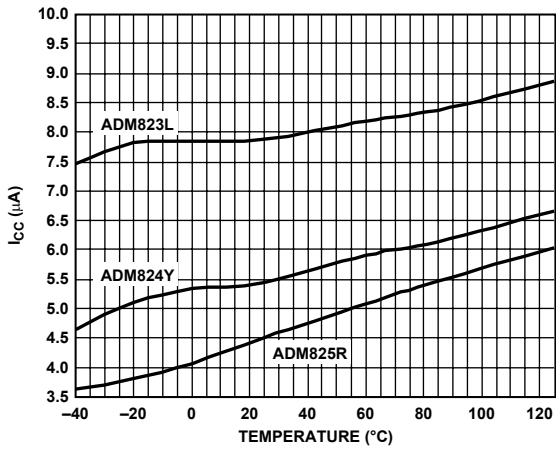

Figure 5. Supply Current vs. Temperature

04534-0-005

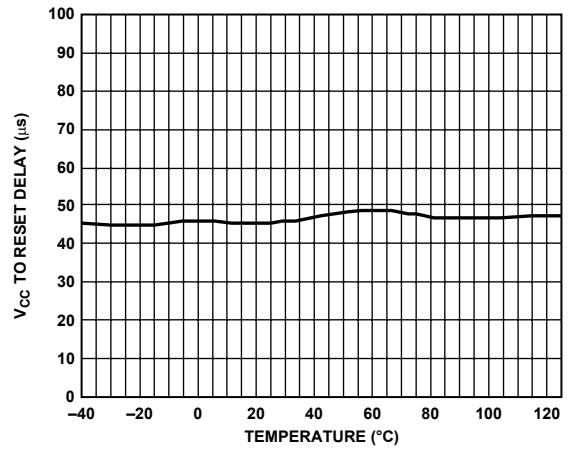

Figure 8. Reset Comparator Propagation Delay vs. Temperature (Vcc Falling)

04534-0-008

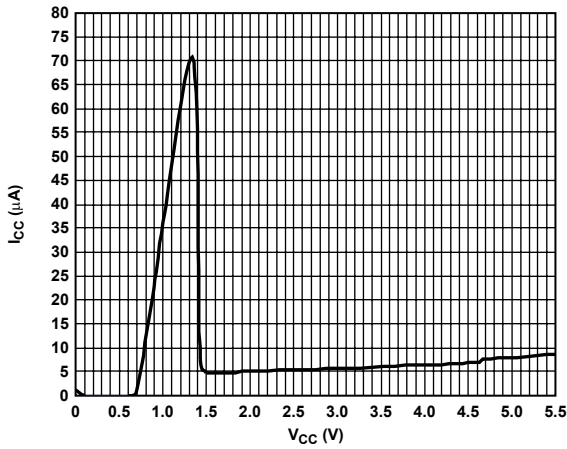

Figure 6. Supply Current vs. Supply Voltage

04534-0-006

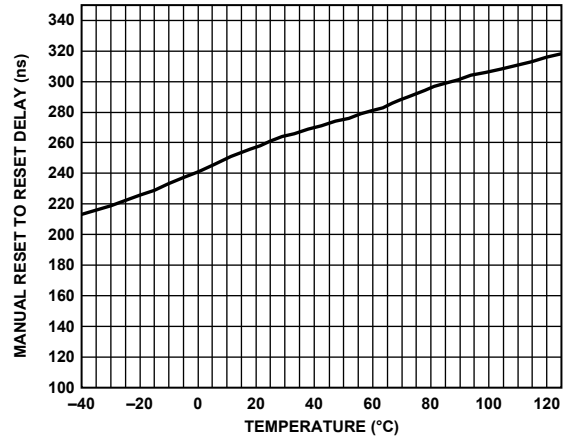

Figure 9. Manual Reset to Reset Propagation Delay vs. Temperature (ADM823/ADM825)

04534-0-009

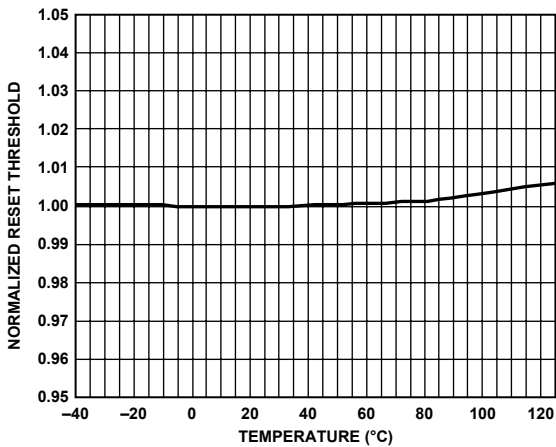

Figure 7. Normalized Reset Threshold vs. Temperature

04534-0-007

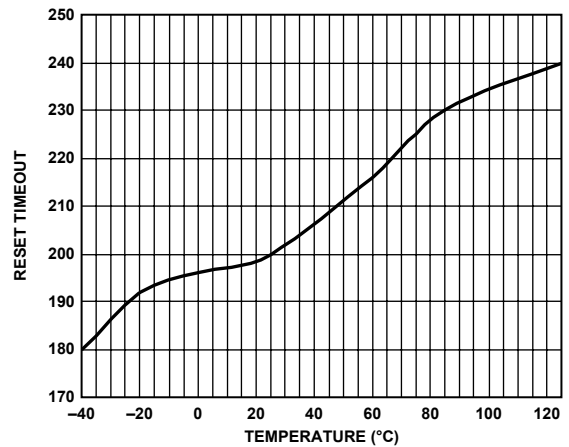
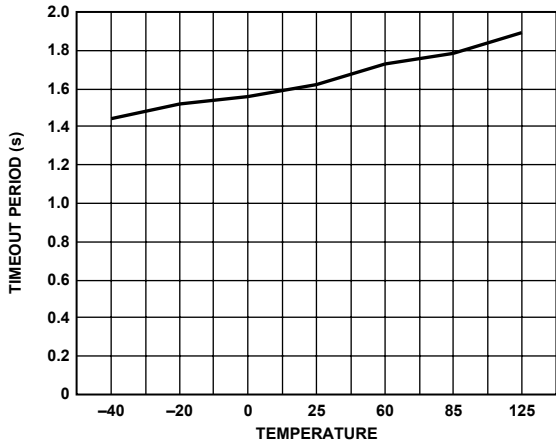

Figure 10. Reset Timeout Period vs. Temperature

04534-0-010



04534-0-011

Figure 11. Watchdog Timeout Period vs. Temperature (ADM823/ADM824)

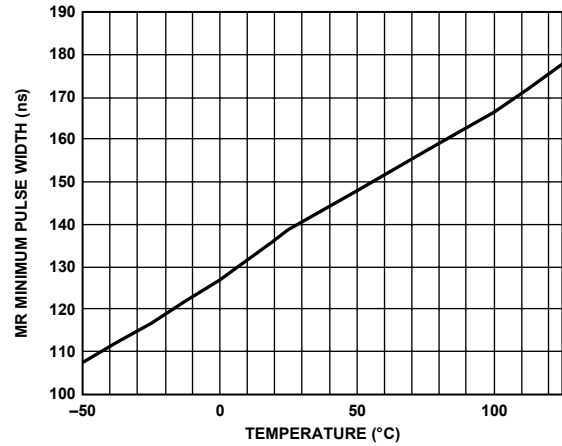

04534-0-013

Figure 13. Manual Reset Minimum Pulse Width vs. Temperature (ADM823/ADM825)

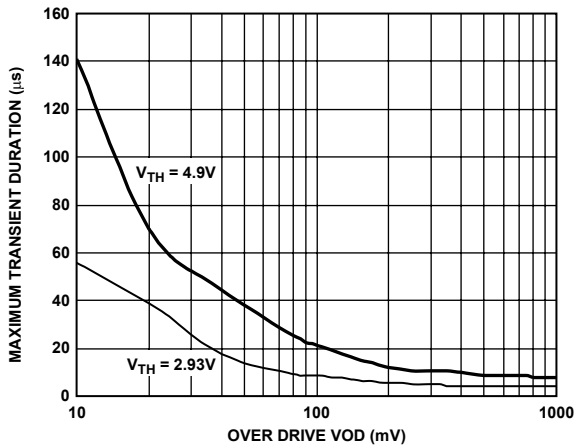

04534-0-012

Figure 12. Maximum V<sub>CC</sub> Transient Duration vs. Reset Threshold Overdrive

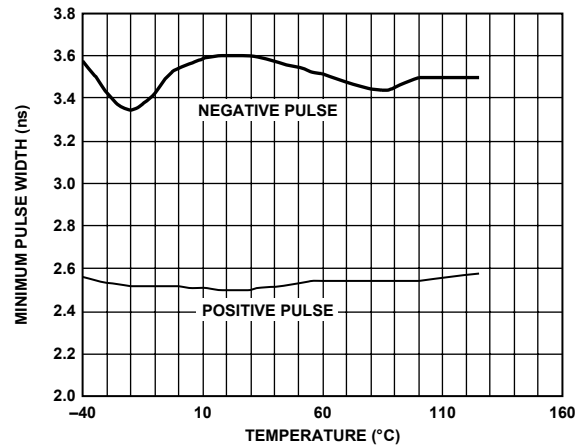

04534-0-014

Figure 14. Watchdog Input Minimum Pulse Width vs. Temperature (ADM823/ADM824)



# OUTLINE DIMENSIONS

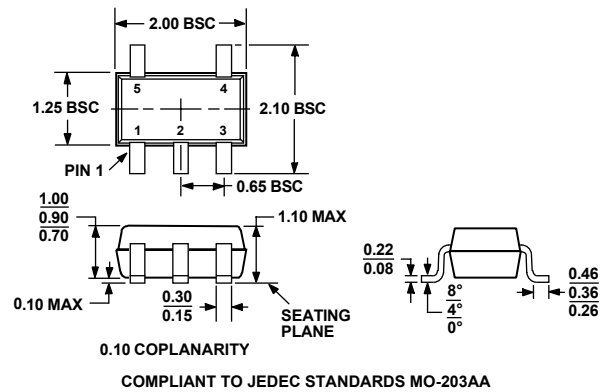

Figure 15. 5-Lead Plastic Surface-Mount Package [SC-70] (KS-5)  
Dimensions shown in millimeters

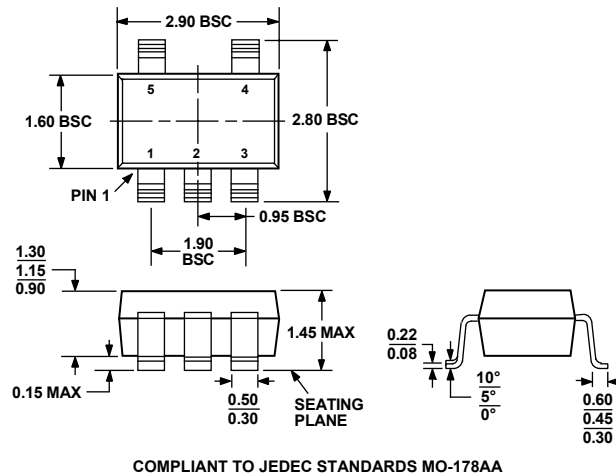

Figure 16. 5-Lead Small Outline Transistor Package [SOT-23] (RJ-5)  
Dimensions shown in millimeters

## ORDERING GUIDES

Table 5. ADM823 Ordering Guide

Model	Reset Threshold (V)	Temperature Range	Quantity	Package Type	Branding
ADM823LYKS-R7	4.63	-40°C to +125°C	3k	SC70-5	N07
ADM823LYRT-R7	4.63	-40°C to +125°C	3k	SOT-23-5	N07
ADM823MYKS-R7	4.38	-40°C to +125°C	3k	SC70-5	N07
ADM823MYRT-R7	4.38	-40°C to +125°C	3k	SOT-23-5	N07
ADM823TYKS-R7	3.08	-40°C to +125°C	3k	SC70-5	N07
ADM823TYRT-R7	3.08	-40°C to +125°C	3k	SOT-23-5	N07
ADM823SYKS-R7	2.93	-40°C to +125°C	3k	SC70-5	N07
ADM823SYRT-R7	2.93	-40°C to +125°C	3k	SOT-23-5	N07
ADM823RYKS-R7	2.63	-40°C to +125°C	3k	SC70-5	N07
ADM823RYRT-R7	2.63	-40°C to +125°C	3k	SOT-23-5	N07
ADM823ZYKS-R7	2.32	-40°C to +125°C	3k	SC70-5	N07
ADM823YYKS-R7	2.19	-40°C to +125°C	3k	SC70-5	N07

Table 6. ADM824 Ordering Guide

Model <sup>1</sup>	Reset Threshold (V)	Temperature Range	Quantity	Package Type	Branding
ADM824LYKS-R7	4.63	-40°C to +85°C	3k	SC70-5	N08
ADM824LYRT-R7	4.63	-40°C to +125°C	3k	SOT-23-5	N08
ADM824MYKS-R7	4.38	-40°C to +85°C	3k	SC70-5	N08
ADM824MYRT-R7	4.38	-40°C to +125°C	3k	SOT-23-5	N08
ADM824TYKS-R7	3.08	-40°C to +85°C	3k	SC70-5	N08
ADM824TYRT-R7	3.08	-40°C to +125°C	3k	SOT-23-5	N08
ADM824SYKS-R7	2.93	-40°C to +85°C	3k	SC70-5	N08
ADM824SYRT-R7	2.93	-40°C to +125°C	3k	SOT-23-5	N08
ADM824RYKS-R7	2.63	-40°C to +85°C	3k	SC70-5	N08
ADM824RYRT-R7	2.63	-40°C to +125°C	3k	SOT-23-5	N08
ADM824ZYKS-R7	2.32	-40°C to +85°C	3k	SC70-5	N08
ADM824YYKS-R7	2.19	-40°C to +85°C	3k	SC70-5	N08

<sup>1</sup> All of the ADM824 models are nonstandard. Contact factory for availability of nonstandard models.

Table 7. ADM825 Ordering Guide

Model <sup>1</sup>	Reset Threshold (V)	Temperature Range	Quantity	Package Type	Branding
ADM825LYKS-R7	4.63	-40°C to +85°C	3k	SC70-5	N09
ADM825LYRT-R7	4.63	-40°C to +125°C	3k	SOT-23-5	N09
ADM825MYKS-R7	4.38	-40°C to +85°C	3k	SC70-5	N09
ADM825MYRT-R7	4.38	-40°C to +125°C	3k	SOT-23-5	N09
ADM825TYKS-R7	3.08	-40°C to +85°C	3k	SC70-5	N09
ADM825TYRT-R7	3.08	-40°C to +125°C	3k	SOT-23-5	N09
ADM825SYKS-R7	2.93	-40°C to +85°C	3k	SC70-5	N09
ADM825SYRT-R7	2.93	-40°C to +125°C	3k	SOT-23-5	N09
ADM825RYKS-R7	2.63	-40°C to +85°C	3k	SC70-5	N09
ADM825RYRT-R7	2.63	-40°C to +125°C	3k	SOT-23-5	N09
ADM825ZYKS-R7	2.32	-40°C to +85°C	3k	SC70-5	N09
ADM825YYKS-R7	2.19	-40°C to +85°C	3k	SC70-5	N09