

HUB CONTROLLER FOR UNIVERSAL SERIAL BUS

The μPD72012 is a dedicated LSI for a HUB connected to a universal serial bus (USB) system. It is an upgrade of NEC's μPD72011. It complies with USB specification revision 1.1. By putting descriptors into ROM, information such as a user's vendor ID can be implemented in the chip.

FEATURES

- Compliant with Chapter 11 (HUB Specifications) of USB Specification 1.1.
- Descriptors into ROM
 - The user can customize the vendor ID and product ID by using Mask ROM option.
- Supports 5 kinds of string descriptors (for Mask ROM code product only)
- On-chip sequencer
 - There is an on-chip descriptor and request response sequencer. External initial setup and control is not needed and HUB functions can be realized using only the μPD72012.
- Downstream ports
 - Four or five ports can be selected using a pin function.
- Power modes
 - Bus power or self-power can be selected using a pin function (an external power control circuit is required).
- Corresponds to standard descriptor products
 - Two kinds of standard ROM code products are provided. Standard and HUB class descriptors are on-chip in the μPD72012.
ROM code: 003 (individual overcurrent monitoring type Generic HUB)
ROM code: 004 (collective overcurrent monitoring type Generic HUB)
- Supports two kinds of clock input
 - 48 MHz oscillator input or a 4 MHz crystal resonator can be supported
- Power control
 - Port power control and overcurrent detection functions are on-chip. Individual port control or collective control can be selected for these.

ORDERING INFORMATION

Part No.	Package
μPD72012CU-XXX	42-pin plastic SDIP (15.24 mm (600))
μPD72012GB-XXX-3B4	44-pin plastic QFP (10 × 10)

The information in this document is subject to change without notice. Before using this document, please confirm that this is the latest version.
Not all devices/types available in every country. Please check with local NEC representative for availability and additional information.

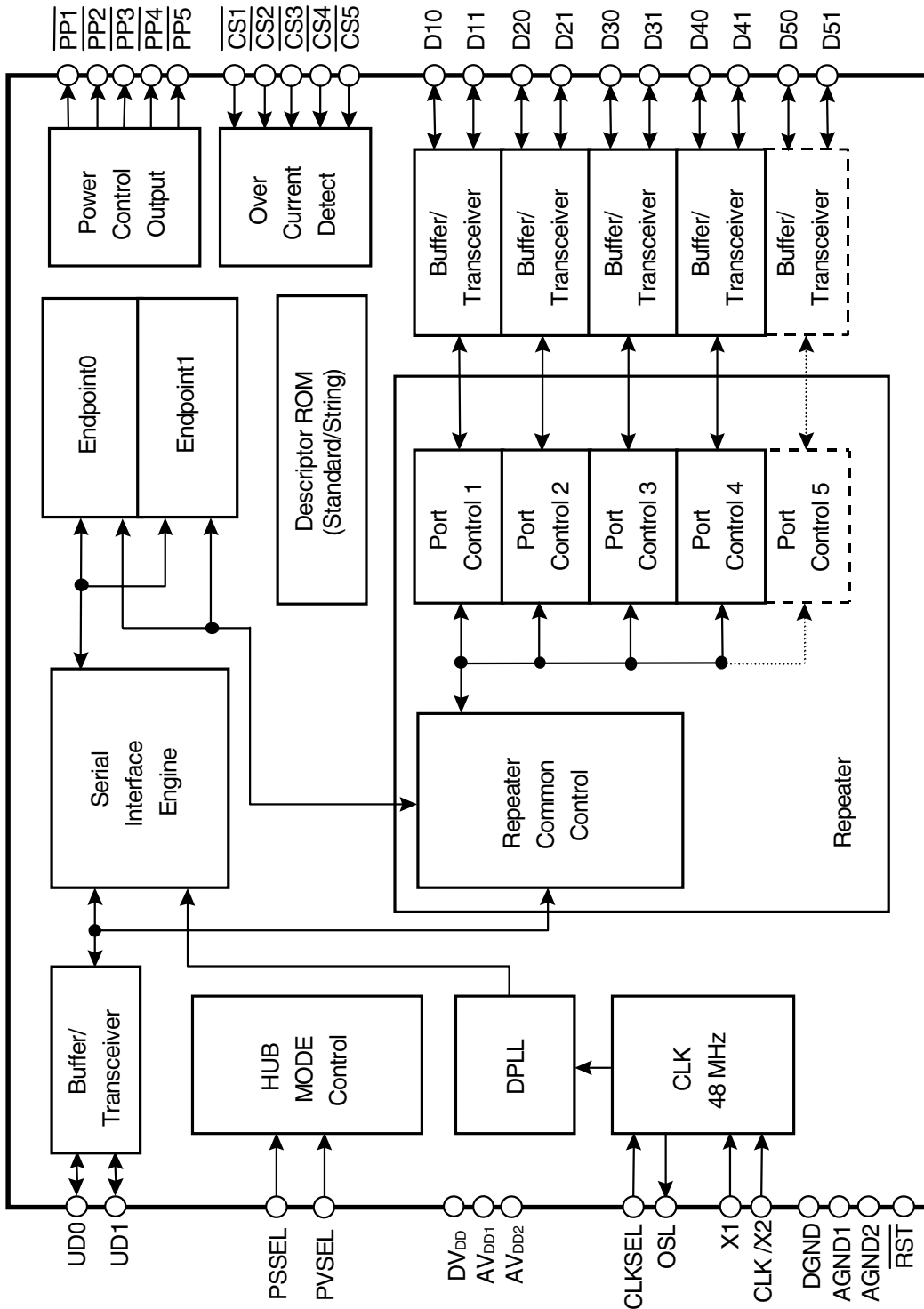

CLK : Connect to 48 MHz OSC Output
 X1, X2 : Connect to 4 MHz Xtal

PIN CONFIGURATION (Top View)

- 42-pin plastic SDIP (15.24 mm (600))

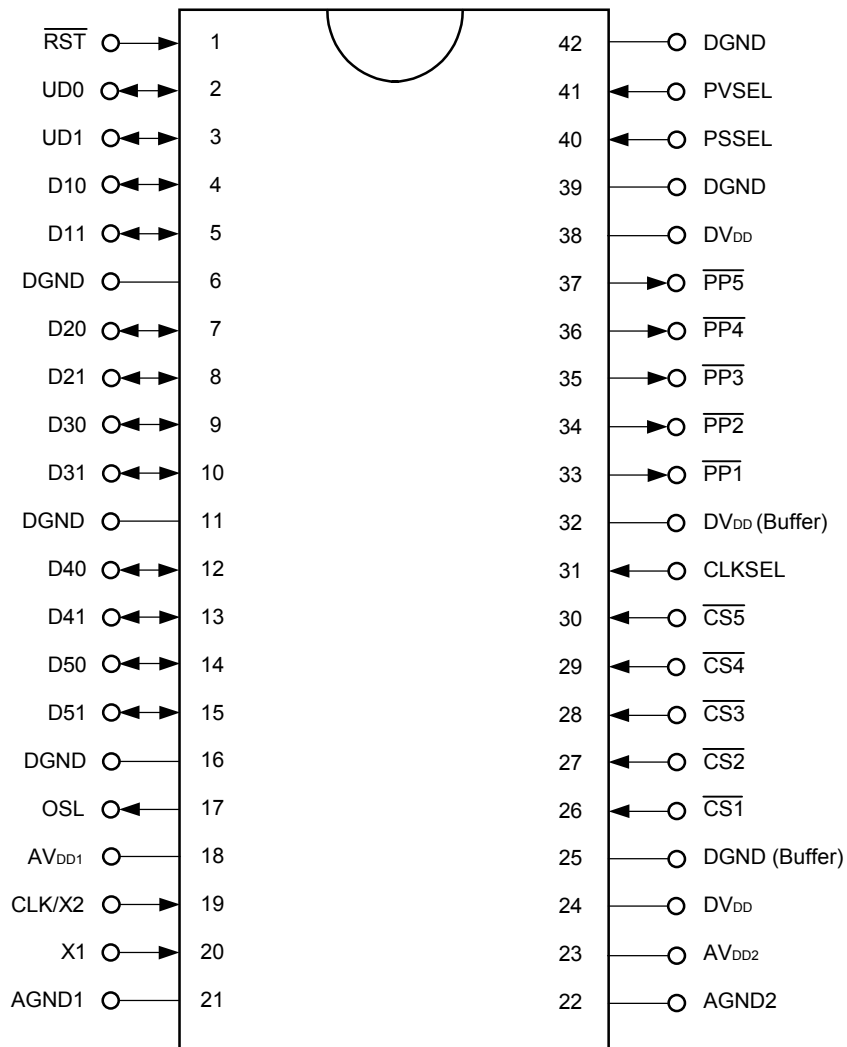

- 44-pin plastic QFP (10×10)

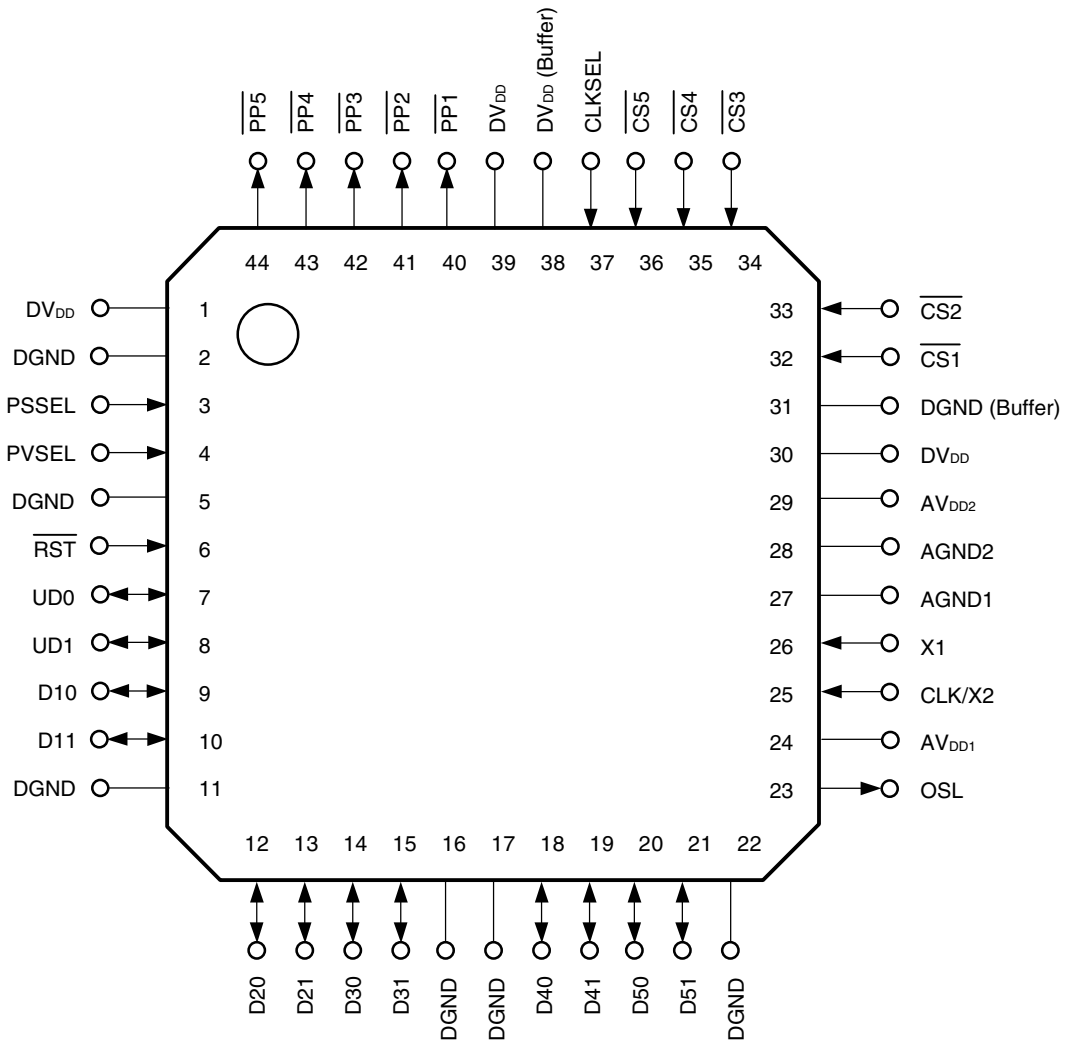

PIN NAME

AGND1	: Analog GND1 (Xtal)	D41	: Downstream Port #4 D-
AGND2	: Analog GND2 (DPLL)	D50	: Downstream Port #5 D+
AV _{DD1}	: Analog V _{DD1} (Xtal)	D51	: Downstream Port #5 D-
AV _{DD2}	: Analog V _{DD2} (DPLL)	DGND	: Digital GND
CLKSEL	: Clock Frequency Control	DGND (Buffer)	: Digital GND (Buffer)
CLK/X2	: 48 MHz OSC, 4 MHz Xtal Clock Input	DV _{DD}	: Digital V _{DD}
$\overline{\text{CS1}}$: Over Current Detect #1	DV _{DD} (Buffer)	: Digital V _{DD} (Buffer)
$\overline{\text{CS2}}$: Over Current Detect #2	OSL	: OSC Suspend Output
$\overline{\text{CS3}}$: Over Current Detect #3	$\overline{\text{PP1}}$: Port Power Control #1
$\overline{\text{CS4}}$: Over Current Detect #4	$\overline{\text{PP2}}$: Port Power Control #2
$\overline{\text{CS5}}$: Over Current Detect #5	$\overline{\text{PP3}}$: Port Power Control #3
D10	: Downstream Port #1 D+	$\overline{\text{PP4}}$: Port Power Control #4
D11	: Downstream Port #1 D-	$\overline{\text{PP5}}$: Port Power Control #5
D20	: Downstream Port #2 D+	PSSEL	: Powered Mode Control
D21	: Downstream Port #2 D-	PVSEL	: Down Port Value Control
D30	: Downstream Port #3 D+	$\overline{\text{RST}}$: Reset
D31	: Downstream Port #3 D-	UD0	: Root Port #0 D+
D40	: Downstream Port #4 D+	UD1	: Root Port #0 D-
		X1	: 4 MHz Xtal Clock Input

CONTENTS

1. PIN FUNCTIONS 7

 1.1 List of Pin Functions 7

 1.2 Tables by Pin Function 10

 1.3 Equivalent Circuits of Pins 11

2. DESCRIPTORS 12

 2.1 Standard Device Descriptor 12

 2.2 Standard Configuration Descriptor 14

 2.3 Standard Interface Descriptor 16

 2.4 Standard Endpoint Descriptor 1 17

 2.5 HUB Class Descriptor 17

 2.6 Standard String Descriptor 0 21

 2.7 Standard String Descriptors 1 Through 5 21

3. ELECTRICAL SPECIFICATIONS 22

4. PACKAGE DRAWINGS 32

5. RECOMMENDED SOLDERING CONDITIONS 34

1. PIN FUNCTIONS

1.1 List of Pin Functions

(1/3)

Pin No. ^{Note}	Pin Name	I/O	Signal Name	Function
1(6)	RST	I	RESET	Inputs reset signals.
2(7)	UD0	I/O	Data0	Connects to upstream port #0 D+ signal line. Pull up to 3.3 V line using 1.5 kΩ.
3(8)	UD1	I/O	Data1	Connects to upstream port #0 D- signal line.
4(9)	D10	I/O	Data0	Connects to downstream port #1 D+ signal line. Pull down to GND using 15 kΩ.
5(10)	D11	I/O	Data1	Connects to downstream port #1 D- signal line. Pull down to GND using 15 kΩ.
6(11)	DGND	-	DGND	Connect to GND.
7(12)	D20	I/O	Data0	Connects to downstream port #2 D+ signal line. Pull down to GND using 15 kΩ.
8(13)	D21	I/O	Data1	Connects to downstream port #2 D- signal line. Pull down to GND using 15 kΩ.
9(14)	D30	I/O	Data0	Connects to downstream port #3 D+ signal line. Pull down to GND using 15 kΩ.
10(15)	D31	I/O	Data1	Connects to downstream port #3 D- signal line. Pull down to GND using 15 kΩ.
11(16, 17)	DGND	-	DGND	Connect to GND. This pin is used as both pins 16 and 17 internally in the QFP product.
12(18)	D40	I/O	Data0	Connects to downstream port #4 D+ signal line. Pull down to GND using 15 kΩ.
13(19)	D41	I/O	Data1	Connects to downstream port #4 D- signal line. Pull down to GND using 15 kΩ.
14(20)	D50	I/O	Data0	Connects to downstream port #5 D+ signal line. Pull down to GND using 15 kΩ.
15(21)	D51	I/O	Data1	Connects to downstream port #5 D- signal line. Pull down to GND using 15 kΩ.
16(22)	DGND	-	DGND (TS3)	Test pin of μPD72012 (corresponds to TS3 pin in μPD72011). Connect to GND.
17(23)	OSL	O	OSC CTL	Pin that outputs high level on suspend. Can be used by LED switch or to turn oscillator ON/OFF on suspend. CAUTION For self-power, always input an oscillator output signal. If the clock is cut-off, subsequent operation may not be possible.

Note QFP pin numbers are shown in ().

(2/3)

Pin No. ^{Note 1}	Pin Name	I/O	Signal Name	Function
18(24)	AV _{DD1}	-	AVDD1	Power supply pin of on-chip clock drive circuit. To stabilize the power supply, connect directly to a stable power supply using the shortest wire possible or connect to GND via a capacitor along the wire (3.3 V input).
19(25)	CLK / X2	I	CLOCK / XTAL	When you input a clock signal from an oscillator, input at the 48 MHz CMOS level (5 V can be input). When using a 4 MHz crystal oscillator, connect the oscillator to this pin.
20(26)	X1	I	XTAL	When using a 4 MHz crystal oscillator, connect the oscillator to this pin.
21(27)	AGND1	-	AGND1	GND pin of on-chip clock drive circuit. Connect to GND.
22(28)	AGND2	-	AGND2	GND pin of on-chip frequency multiplier (PLL). Connect to GND.
23(29)	AV _{DD2}	-	AVDD2	Power supply pin of on-chip frequency multiplier (PLL). To stabilize the power supply, connect directly to a stable power supply using the shortest wire possible or connect to GND via a capacitor along the wire (3.3 V input).
24(30)	DV _{DD}	-	DVDD (TS1)	Test pin of μPD72012 (corresponds to TS1 pin in μPD72011). Connect to 3.3 V power supply.
25(31)	DGND (Buffer)	-	DGND (Buffer)	Connect to GND.
26(32)	$\overline{CS1}$	I	PORTCURRENT1	Low active input pin that inputs overcurrent states detected by external circuit of downstream port #1. When not using this pin, connect it directly to V _{DD} . ^{Note 2}
27(33)	$\overline{CS2}$	I	PORTCURRENT2	Low active input pin that inputs overcurrent states detected by external circuit of downstream port #2. When not using this pin, connect it directly to V _{DD} . ^{Note 2}
28(34)	$\overline{CS3}$	I	PORTCURRENT3	Low active input pin that inputs overcurrent states detected by external circuit of downstream port #3. When not using this pin, connect it directly to V _{DD} . ^{Note 2}
29(35)	$\overline{CS4}$	I	PORTCURRENT4	Low active input pin that inputs overcurrent states detected by external circuit of downstream port #4. When not using this pin, connect it directly to V _{DD} . ^{Note 2}
30(36)	$\overline{CS5}$	I	PORTCURRENT5	Low active input pin that inputs overcurrent states detected by external circuit of downstream port #5. When not using this pin, connect it directly to V _{DD} . ^{Note 2}

Notes 1. Pin numbers for QFP are shown in ().

2. For details, refer to **Table 1-3 in 1.2 Tables by Pin Function.**

(3/3)

Pin No. ^{Note 1}	Pin Name	I/O	Signal Name	Function
31(37)	CLKSEL	I	CLK SELECT	Pin for selecting whether to use 48 MHz oscillator or 4 MHz crystal oscillator (refer to Table 1-1).
32(38)	DV _{DD} (Buffer)	-	DVDD (Buffer)	Connect to 3.3 V power supply.
(39)	DV _{DD}	-	DVDD	Connect to 3.3 V power supply. This pin is used together with pin No. 32 internally in the shrink DIP product.
33(40)	$\overline{PP1}$	O	PORTPOWER#1	Low active open drain output pin that controls downstream port #1 power supply. Input the output of this pin to the power control element of an external circuit. If not using this pin, leave it unconnected. ^{Note 2}
34(41)	$\overline{PP2}$	O	PORTPOWER#2	Low active open drain output pin that controls downstream port #2 power supply. Input the output of this pin to the power control element of an external circuit. If not using this pin, leave it unconnected. ^{Note 2}
35(42)	$\overline{PP3}$	O	PORTPOWER#3	Low active open drain output pin that controls downstream port #3 power supply. Input the output of this pin to the power control element of an external circuit. If not using this pin, leave it unconnected. ^{Note 2}
36(43)	$\overline{PP4}$	O	PORTPOWER#4	Low active open drain output pin that controls downstream port #4 power supply. Input the output of this pin to the power control element of an external circuit. If not using this pin, leave it unconnected. ^{Note 2}
37(44)	$\overline{PP5}$	O	PORTPOWER#5	Low active open drain output pin that controls downstream port #5 power supply. Input the output of this pin to the power control element of an external circuit. If not using this pin, leave it unconnected. ^{Note 2}
38(1)	DV _{DD}	-	DVDD (TS0)	Test pin of μPD72012 (corresponds to TS0 pin in μPD72011). Connect to 3.3 V power supply.
39(2)	DGND	-	DGND	Connect to GND.
40(3)	PSSEL	I	Power SW	Pin that selects switching between bus power and self-power (refer to Table 1-2). To make high level, pull up to 3.3 V.
41(4)	PVSEL	I	Port Value	Pin that selects switching between number (4 or 5) of downstream ports (refer to Table 1-2). To make high level, pull up to 3.3 V.
42(5)	DGND	-	DGND (TS2)	Test pin of μPD72012 (corresponds to TS2 pin in μPD72011). Connect to GND.

Notes 1. QFP pin numbers are shown in ().

2. For details, refer to **Table 1-4 of 1.2 Tables by Pin Function**.

1.2 Tables by Pin Function

Table 1-1. Oscillator Circuit Switching Control (CLKSEL)

CLKSEL	Type of oscillator circuit
L	Input clocks from 48 MHz oscillator
H	Clock input using 4 MHz crystal resonator (drive circuit is incorporated)

Remark Directly connect to V_{DD} when using CLKSEL="H". Even 5 V is no trouble.

Table 1-2. Power Mode/Downstream Port Number Control (PSSEL, PVSEL)

PSSEL	PVSEL	Power mode	Port #1	Port #2	Port #3	Port #4	Port #5
L	L	Self-power ^{Note 1}	○	○	○	○	×
L	H	Self-power ^{Note 1}	○	○	○	○	○
H	L	Bus power ^{Note 2}	○	○	○	○	×
H	H	Prohibited ^{Note 3}	–	–	–	–	–

- Notes**
1. Do not cut-off clock input when using self-power. If it is cut-off, internal functions stop and operation may not be possible even if clocks are input again.
 2. When using bus power, up to four ports can be used.
 3. The combination PSSEL="H", PVSEL="H" is prohibited. Operation in this case is not guaranteed.

Remark Also set according to this table when setting the number of ports in a Mask ROM code product to up to 5 ports. Directly connect data lines of unused ports to GND.

Table 1-3. Handling of Pins $\overline{CS1}$ to $\overline{CS5}$ According to Setting of wHubCharacteristics Field of HUB Class Descriptor

wHubCharacteristics Bits 4, 3	$\overline{CS1}$	$\overline{CS2}$	$\overline{CS3}$	$\overline{CS4}$	$\overline{CS5}$
0b00	Common in all ports				
0b01	Port #1	Port #2	Port #3	Port #4	Port #5
0b10 or 0b11	Not available	Not available	Not available	Not available	Not available

Remark Connect pins $\overline{CS1}$ to $\overline{CS5}$ to the Over Current Detect output pin of the power switch IC. Clamp an unused or unavailable $\overline{CS1}$ to $\overline{CS5}$ pin to 3.3 V.

★ Table 1-4. Handling of Pins $\overline{PP1}$ to $\overline{PP5}$ According to Setting of wHubCharacteristics Field of HUB Class Descriptor

wHubCharacteristics Bits 1, 0	$\overline{PP1}$	$\overline{PP2}$	$\overline{PP3}$	$\overline{PP4}$	$\overline{PP5}$
0b00	Common in all ports				
0b01	Port #1	Port #2	Port #3	Port #4	Port #5

Remark Connect pins $\overline{PP1}$ to $\overline{PP5}$ to the Port Power Control input pin of the power switch IC. Leave an unused or unavailable $\overline{PP1}$ to $\overline{PP5}$ pin open.

1.3 Equivalent Circuits of Pins

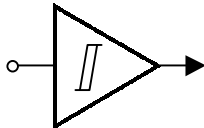
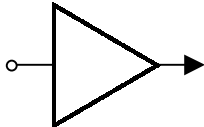
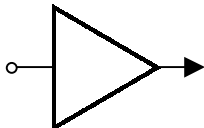
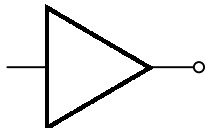
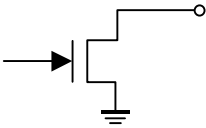
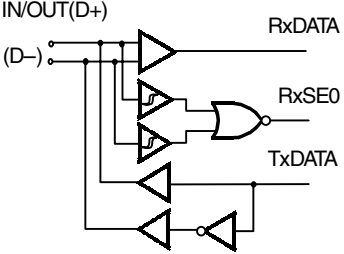
Type	Equivalent Circuit	Pins	Function
★ 5 V tolerant input pin (Schmitt)	 <p>5 V Schmitt on-chip</p>	\overline{RST} , $\overline{CS1}$ to $\overline{CS5}$	3.3 V Schmitt input pin with 5 V tolerant.
★ 5 V tolerant input pin	 <p>5 V</p>	CLKSEL, PSSEL, PVSEL	3.3 V input pin with 5 V tolerant.
★ 5 V tolerant clock input pin	 <p>5 V</p>	X1, CLK/X2	3.3 V dedicated clock input pin with 5 V tolerant.
★ 5 V tolerant 3.3 V output pin	 <p>3.3 V, $I_{OL}=6$ mA</p>	OSL	3.3 V output pin with 5 V tolerant. Pull-up to 5 V line is possible.
Open-drain output pin		$\overline{PP1}$ to $\overline{PP5}$	Open-drain structure pin.
USB buffer		UD0, UD1, D10 to D50, D11 to D51	USB buffer. The two kinds of receiver are DATA receiver and SE0 (single end 0) receiver on the receiving side. On the sending side, rise and fall times are managed in the last stage of the buffer in order to create a difference between low-speed and full-speed.

2. DESCRIPTORS

★ **Caution** For a Mask ROM code product, we release the software to make a data for Mask ROM option. Please contact to Local NEC to get the software if you would like to make Mask ROM code product.

2.1 Standard Device Descriptor

(1/2)

No.	Field	Size (Bytes)	Contents	Value		
				Standard ROM code product		Mask ROM code product
				003	004	
0	bLength	1	Shows the size in bytes of the standard device descriptor.	0x12	0x12	0x12
1	bDescriptorType	1	Shows that this is a standard device descriptor.	0x01	0x01	0x01
2	bcdUSB	2	Shows that the μPD72012 compliant with USB Specifications Revision 1.1.	0x0110	0x0110	0x0110
4	bDeviceClass	1	HUB class code defined by USB (HUB_CLASSCODE="0x09").	0x09	0x09	0x09
5	bDeviceSubClass	1	HUB subclass code defined by USB. Not defined in HUB class.	0x00	0x00	0x00
6	bDeviceProtocol	1	Protocol code defined by USB. Not defined in HUB class.	0x00	0x00	0x00
7	bMaxPacketSize0	1	Shows the maximum packet size in bytes of endpoint 0 of the μPD72012.	0x08	0x08	0x08
8	idVendor	2	Shows the vendor ID code registered in USB standards. For a standard ROM code product (003, 004), this is "0x0409" (NEC vendor ID). When using in a Mask ROM code product, set a vendor ID for each manufacturer registered in USB standards.	0x0409	0x0409	<u>0xXXXX</u>
10	IdProduct	2	Shows the product ID code registered in USB standards. For a standard ROM code product (003, 004), this is "0x55AB" (Generic_HUB). In a Mask ROM code product, this value can be set as you wish.	0x55AB	0x55AB	<u>0xXXXX</u>
12	bcdDevice	2	Shows the version number of the μPD72012 using decimal notation in XX.XX format. For a standard ROM code product (003, 004), this is "0x0200" (Ver. 2.0). When using in a Mask ROM code product, manage by varying the number for each ROM code.	0x0200	0x0200	<u>0xXXXX</u>

(2/2)

No.	Field	Size (Bytes)	Contents	Value		
				Standard ROM code product		Mask ROM code product
				003	004	
14	iManufacture	1	Shows the index of the string descriptor for a comment about a manufacturer using the HUB. Since not used for a standard ROM code product (003, 004), its value is "0x00". When using this for a Mask ROM code product, set it to "0x01".	0x00	0x00	<u>0x00</u> or <u>0x01</u>
15	iProduct	1	Shows the index of the string descriptor for a comment about a product using the HUB. Since not used for a standard ROM code product (003, 004), its value is "0x00". When using this for a Mask ROM code product, set it to "0x02".	0x00	0x00	<u>0x00</u> or <u>0x02</u>
16	iSerialNumber	1	Shows the index of the string descriptor for the serial number of a product using the HUB. Since not used for a standard ROM code product (003, 004), its value is "0x00". When using this for a Mask ROM code product, set it to "0x03".	0x00	0x00	<u>0x00</u> or <u>0x03</u>
17	bNumConfiguration	1	Shows the number of configurations that can be set for this HUB. Its value is fixed at "0x01" for the μPD72012	0x01	0x01	0x01

2.2 Standard Configuration Descriptor

(1/2)

No.	Field	Size (Bytes)	Contents	Value		
				Standard ROM code product		Mask ROM code product
				003	004	
0	bLength	1	Shows the size in bytes of the standard configuration descriptor.	0x09	0x09	0x09
1	bDescriptorType	1	Shows that this is a standard configuration descriptor.	0x02	0x02	0x02
2	wTotalLength	2	Shows the total length of descriptors returned on a host Get_Descriptor (Configuration) request (standard configuration, standard interface, each standard endpoint, and HUB class descriptors).	0x0019	0x0019	0x0019
4	bNumInterface	1	Shows the number of interfaces that can be set in this configuration. Its value is fixed at "0x01" for the μPD72012.	0x01	0x01	0x01
5	bConfigurationValue	1	Specifying this value in a Set_Configuration request from the host sets this configuration in the μPD72012.	0x01	0x01	0x01
6	iConfiguration	1	Shows the index of the string descriptor for a comment about the configuration of a product using the HUB. Since not used for a standard ROM code product (003, 004), its value is "0x00". When using this for a Mask ROM code product, set it to "0x04".	0x00	0x00	<u>0x00</u> or <u>0x04</u>
7	bmAttributes	1	Uses a bitmap to show the power supply attributes of this configuration of the μPD72012. Caution Since the information "Self-power" in the status returned on a Get_Status request from the host reflects the level input to the PSEL pin, be sure that there are no inconsistencies. "0xE0": Corresponds to both "bus power" and "self-power" modes and shows that "Remote Wakeup" is supported. A standard ROM code product has this setting. Use this setting when using in "self-power" mode only or when switching between "bus power" and "self-power" by performing a PSEL pin function. "0xA0": Corresponds to "bus power" mode only and shows that "Remote Wakeup" is supported. Make this setting when using in "bus power" mode only.	0xE0	0xE0	<u>0xE0</u> or <u>0xA0</u>

(2/2)

No.	Field	Size (Bytes)	Contents	Value		
				Standard ROM code product		Mask ROM code product
				003	004	
8	MaxPower	1	<p>Shows the maximum current the HUB consumes in normal operation in hexadecimal notation using units of 2 mA.</p> <p>Since it provides 1 UnitLoad (= 100 mA) to each port downstream, this is not included in MaxPower. However, if a non-removable device is connected downstream, this is included (for details inquire in the USB-IF).</p> <p>Switching the input level of the PSSEL pin changes the value that is returned. In short, two-way setting of the μPD72012 is possible for “self-power” and “bus power”.</p> <p>Mask ROM code product</p> <p>For a “bus power” setting (PSSEL=“H”), normally set this to 0x32 (100 mA). However, when making a subordinate port a non-removable port, add the current consumed by the device connected to that port when you set the MaxPower value. On the other hand, For a “self-power” setting (PSSEL=“L”), 0x32 (100 mA) is fixed.</p>	<p>0x32 (PSSEL=“L”)</p> <p>or</p> <p>0x32 (PSSEL=“H”)</p>	<p>0x32 (PSSEL=“L”)</p> <p>or</p> <p>0x32 (PSSEL=“H”)</p>	<p><u>0x32</u> (PSSEL=“L”)</p> <p>or</p> <p><u>0x32</u> (PSSEL=“H”)</p> <p>(recommended value)</p>

★

2.3 Standard Interface Descriptor

No.	Field	Size (Bytes)	Contents	Value		
				Standard ROM code product		Mask ROM code product
				003	004	
0	bLength	1	Shows the size in bytes of the standard interface descriptor.	0x09	0x09	0x09
1	bDescriptorType	1	Shows that this is a standard interface descriptor.	0x04	0x04	0x04
2	bInterfaceNumber	1	If there are multiple interfaces, the host specifying this value in a Set_Interface request selects this interface. This is "0x00" for the μPD72012.	0x00	0x00	0x00
3	bAlternateSetting	1	This value is used if there is an alternate setting of the interface. It is "0x00" for the μPD72012.	0x00	0x00	0x00
4	bNumEndpoints	1	Shows the number of endpoints defined in this interface.	0x01	0x01	0x01
5	bInterfaceClass	1	HUB class code defined by USB (HUB_CLASSCODE="0x09").	0x09	0x09	0x09
6	bInterfaceSubClass	1	HUB subclass code defined by USB.	0x00	0x00	0x00
7	bInterfaceProtocol	1	Protocol code defined by USB. Not defined in HUB class.	0x00	0x00	0x00
8	iInterface	1	Shows the index of the string descriptor for a comment about the interface of a product using the HUB. Since not used for a standard ROM code product (003, 004), its value is "0x00". When using this for a Mask ROM code product, set it to "0x05".	0x00	0x00	<u>0x00</u> or <u>0x05</u>

2.4 Standard Endpoint Descriptor 1

No.	Field	Size (Bytes)	Contents	Value		
				Standard ROM code product		Mask ROM code product
				003	004	
0	bLength	1	Shows the size in bytes of standard endpoint descriptor 1.	0x07	0x07	0x07
1	bDescriptorType	1	Shows that this is a standard endpoint descriptor.	0x05	0x05	0x05
2	bEndpointAddress	1	Shows the EndpointAddress of endpoint 1.	0x81	0x81	0x81
3	bmAttributes	1	Shows the attributes of endpoint 1 (Interrupt="0x03").	0x03	0x03	0x03
4	wMaxPacketSize	2	Shows the maximum packet size of endpoint 1.	0x0001	0x0001	0x0001
6	bInterval	1	For an Interrupt attribute endpoint, shows the polling time in milliseconds using hexadecimal notation. For a HUB, the maximum value that can be set ("0xFF") is entered.	0xFF	0xFF	0xFF

2.5 HUB Class Descriptor

(1/4)

No.	Field	Size (Bytes)	Contents	Value		
				Standard ROM code product		Mask ROM code product
				003	004	
0	bDescLength	1	Shows the size in bytes of the HUB class descriptor.	0x09	0x09	0x09
1	bDescriptorType	1	Shows that this is a HUB class descriptor.	0x29	0x29	0x29
2	bNbrPort	1	Shows the number of downstream ports the HUB supports in a set. For a standard ROM code product (003, 004), the value varies according to the PVSEL pin setting. It is "0x05" for a 5-port HUB (PVSEL="H"), and "0x04" for a 4-port HUB (PVSEL="L"). For a Mask ROM code product, the value in this field can be set arbitrarily. Since two-way setting by switching the PVSEL input level is possible for these values, perform two-way specification. Note that the values that are set for PVSEL="H" are from "0x01" to "0x05", and the values that are set for PVSEL="L" are from "0x01" to "0x04". The μPD72012 enables ports in turn starting from the smallest port number.	0x04 (PVSEL="L") or 0x05 (PVSEL="H")	0x04 (PVSEL="L") or 0x05 (PVSEL="H")	0xXX (PVSEL="L") or 0xYY (PVSEL="H")

(2/4)

No.	Field	Size (Bytes)	Contents	Value		
				Standard ROM code product		Mask ROM code product
				003	004	
3	wHubCharacteristics	2	<p>Uses a bitmap to show attributes of the μPD72012. The meaning of each bit is as follows.</p> <p>Bits 1,0: Show the power switch switching attribute. “0b00”: Enable all power switches at once. This is the value for a standard ROM code product (004). If this value is set for a Mask ROM code product, all of pins $\overline{PP1}$ to $\overline{PP5}$ operate at once.</p> <p>“0b01”: Enable power switches individually for each port. This is the value for a standard ROM code product (003). If this value is set for a Mask ROM code product, pins $\overline{PP1}$ to $\overline{PP5}$ operate individually.</p> <p>“0b1X”: Reserved. Used only on 1.0 compliant hubs that implement no power switching. You can not use this setting for μPD72012.</p> <p>Bit 2: Identifier of a compound device. Set this to “0b0” when using the μPD72012 as a unit HUB and to “0b1” when using it as compound devices. “0b0”: Shows that the μPD72012 is standalone HUB unit. “0b1”: Shows that μPD72012 is a part of compound devices.</p> <p>Bits 4,3: Show the overcurrent protection switching attribute. “0b00”: Monitor overcurrent for all ports in a batch. Since this is the value for a standard ROM code product (004), a circuit that can control all overcurrent protection functions at once externally is needed. If this value is set for a Mask ROM code product, when one of the pins $\overline{CS1}$ to $\overline{CS5}$ detect overcurrent, Hub reports overcurrent on per- hub basis.</p>	0x0009	0x0000	<u>0x00XX</u>

★

★

★

★

★

(3/4)

No.	Field	Size (Bytes)	Contents	Value		
				Standard ROM code product		Mask ROM code product
				003	004	
3	wHubCharacteristics	2	<p>“0b01”: Monitor overcurrent for each port individually. Since this is the setting for a standard ROM code product (003), a circuit that can individually control overcurrent protection functions externally is needed. If this value is set for a Mask ROM code when one of the pins $\overline{CS1}$ to $\overline{CS5}$ detect overcurrent, Hub reports overcurrent on per- port basis.</p> <p>“0b1X”: Shows that there is no overcurrent protection function. This setting is allowed only for bus-powered hubs that do not implement over-current protection. If this value is set for a Mask ROM code product, clamp all of the pins $\overline{CS1}$ to $\overline{CS5}$ to 3.3 V.</p> <p>Bits 15-5: These bits are reserved in the USB standard for future extended functions. For a Mask ROM code product, be sure to set these bits to “0”.</p> <p>Caution Be sure to set the values in bits 3 and 0 the same in Mask ROM code product settings.</p>	0x0009	0x0000	<u>0x00XX</u>
5	bPowerOn2PwrGood	1	<p>Shows the time from detecting a device at a port and starting the power-on sequence until the power supply stabilizes. Two milliseconds are taken as one unit. This is 100 ms for the μPD72012.</p>	0x32	0x32	0x32
6	bHubContrCurrent	1	<p>Shows the maximum current consumption of the HUB in mA. Note that this value does not show the rated current consumption value for the μPD72012 itself. For a standard ROM code product, “0x50” is applied for compatibility with the μPD72011. This value can be defined for a Mask ROM code product. However, this value should not be less than the current consumption value of the μPD72012 that is described in 3. ELECTRICAL SPECIFICATIONS.</p>	0x50	0x50	<u>0xXX</u>

★

★

★

(4/4)

No.	Field	Size (Bytes)	Contents	Value		
				Standard ROM code product		Mask ROM code product
				003	004	
★ 7	bDeviceRemovable	1	<p>Uses a bitmap to show whether or not removable devices are connected to HUB ports. "1" shows that the connected device is non-removable, and "0" shows that it is removable. Set "1" if a port that is used cannot be connected nor disconnected using an external circuit. Note that, if a non-removable device is connected to a downstream port of the HUB, bit 2 of wHubCharacteristics field should be set to "1". When the number of ports that can be port enabled is limited by the PVSEL pin setting or Mask ROM code product settings, set "0" for all ports that are not port enabled. The meaning of the bitmap is as follows.</p> <p>Bit 0: Always set to "0". Bit 1: If "1", the device connected to port 1 is non-removable. Bit 2: If "1", the device connected to port 2 is non-removable. Bit 3: If "1", the device connected to port 3 is non-removable. Bit 4: If "1", the device connected to port 4 is non-removable. Bit 5: If "1", the device connected to port 5 is non-removable. Bits 7,6: Always set to "0".</p> <p>For a standard ROM code product (003, 004), all ports are removable.</p>	0x00	0x00	<u>0xXX</u>
★ 8	bPortPwrCtrlMask	1	<p>This field exists for reasons of compatibility with software written for 1.0 compliant devices. All bits in this field should be set to 1B.</p>	0xFF	0xFF	0xFF

2.6 Standard String Descriptor 0

Standard string descriptor 0 cannot be used in a standard ROM code product.

No.	Field	Size (Bytes)	Contents	Value		
				Standard ROM code product		Mask ROM code product
				003	004	
0	bLength	1	Shows the size of standard string descriptor 0.	0x00	0x00	<u>0x04</u>
1	bDescriptorType	1	Shows that this is a standard string descriptor.	0x00	0x00	<u>0x03</u>
2	wLANGID[0]	2	Shows the LanguageID of standard string descriptor 0. The LanguageID used is "0x0409" (Generic). The μPD72012 uses this LanguageID in common for all string descriptors.	0x0000	0x0000	<u>0x0409</u>

2.7 Standard String Descriptors 1 Through 5

Standard string descriptors 1 through 5 cannot be used in a standard ROM code product.

This format is the common format for standard string descriptors #1 through #5 of the μPD72012.

No.	Field	Size (Bytes)	Contents	Value		
				Standard ROM code product		Mask ROM code product
				003	004	
0	bLength	1	Shows the size of standard string descriptors 1 through 5. Its value is fixed at 66 bytes (0x42). The string itself is this size -2 (64 bytes).	0x00	0x00	<u>0x42</u>
1	bDescriptorType	1	Shows that this is a standard string descriptor.	0x00	0x00	<u>0x03</u>
2	bString	64	Stores the standard string descriptor in UNICODE. A string requires 2 bytes for each character. Strings of up to 32 characters can be specified. If there are white space characters, pad using NULL characters (0x0000).	All 0	All 0	-

Remark Five kinds of standard string descriptors can be defined and these describe the following contents using 32 UNICODE characters.

Index	Contents
1	Comment about manufacturer (Manufacture) that uses HUB
2	Comment about product (Product) that uses HUB
3	Serial number (SerialNumber) of product that uses HUB
4	Comment about configuration (Configuration) of product that uses HUB
5	Comment about interface (Interface) of product that uses HUB

Refer to "The Unicode Standard, Worldwide Character Encoding, Version 1.0, Volume 1 and 2", The Unicode Consortium, Addison-Wesley Publishing Company, Reading, Massachusetts regarding UNICODE.

3. ELECTRICAL SPECIFICATIONS

Absolute Maximum Ratings

Parameter	Symbol	Conditions	Rating	Unit
Power supply voltage	V _{DD}		-0.5 to +4.6	V
Input voltage	V _I	USB buffer UD0, UD1, D10 to D50, D11 to D51	-0.5 to +4.6	V
		Clock input buffer X1, CLK/X2	-0.5 to +6.6	V
		5 V Schmitt input buffer RST, CS1 to CS5	-0.5 to +6.6	V
		5 V input buffer CLKSEL, PSSEL, PVSEL	-0.5 to +4.6	V
Output voltage	V _O	USB buffer UD0, UD1, D10 to D50, D11 to D51	-0.5 to +4.6	V
		Open drain output buffer PP1 to PP5	-0.5 to +6.6	V
		5 V output buffer OSL	-0.5 to +6.6	V
Output current	I _O		100	mA
Operating ambient temperature	T _A		0 to +70	°C
Storage temperature	T _{stg}		-65 to +150	°C

Caution Product quality may suffer if the absolute maximum rating is exceeded even momentarily for any parameter. That is, the absolute maximum ratings are rated values at which the product is on the verge of suffering physical damage, and therefore the product must be used under conditions that ensure that the absolute maximum ratings are not exceeded.

Recommended Operating Conditions (T_A = 0 to +70°C)

Parameter	Symbol	Conditions	MIN.	TYP.	MAX.	Unit
Power supply voltage	V _{DD}		3.0	3.3	3.6	V
High level input voltage	V _{IH}	USB pin UD0, UD1, D10 to D50, D11 to D51	2.0		V _{DD}	V
Low level input voltage	V _{IL}		0		0.8	V
High level input voltage	V _{IH}	5 V Schmitt input pin RST, CS1 to CS5	2.3		5.5	V
Low level input voltage	V _{IL}		0		0.8	V
★ Input rise time for $\overline{\text{RST}}$	t _r	0.3 V to 2.7 V			10	ms
High level input voltage	V _{IH}	5 V input pin CLKSEL, PSSEL, PVSEL	2.0		5.5	V
Low level input voltage	V _{IL}		0		0.8	V
High level input voltage	V _{IH}	Clock input pin (at 48 MHz input) X1, CLK/X2	2.3		5.5	V
Low level input voltage	V _{IL}		0		0.8	V
Clock input frequency	f _{CK}	Oscillator input (±100 ppm)		48.00		MHz
		Oscillator input (±50 ppm)		4.0		MHz

Recommended Oscillator Circuit Constants

Crystal oscillator (T_A = 0 to +70°C)

Manufacturer	Product name	Frequency (MHz)	Oscillator circuit constant (pF)	
			C1	C2
DAISHINKU CORP.	AT-49	4.000	10	10
	HC-49/U	4.000	9	9

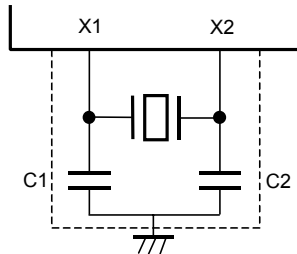

- Cautions**
1. The oscillator circuit constants, which show the conditions for stabilizing and oscillating, do not guarantee oscillation frequency accuracy. If the mounting circuit requires oscillation frequency accuracy, it must be possible to adjust the oscillation frequency of the oscillator in the mounting circuit. Therefore, ask the manufacturer of the oscillator you use about this directly.
 2. When using an oscillator circuit, wire portions shown using broken lines in the figure as follows to avoid affecting wire capacitance.
 - Keep the wiring length as short as possible.
 - Do not cross the wiring with the other signal lines.
 - Do not route the wiring near a signal line through which a high fluctuating current flows.
 - Always keep the ground point of the oscillator capacitor to the same potential as V_{SS}.
 - Do not ground the capacitor to a ground pattern in which a high current flows.
 - Do not fetch signals from the oscillator.

DC Characteristics ($V_{DD} = 3.3\text{ V} \pm 0.3\text{ V}$, $T_A = 0\text{ to }+70^\circ\text{C}$)

(1) Current consumption

Parameter	Symbol	Conditions	MIN.	TYP.	MAX.	Unit
Current consumption	I_{DD}	$f_{CK} = 48\text{ MHz}, 4\text{ MHz}$			40	mA
Current consumption (during suspend)	$I_{DD(SUS)}$				120	μA

(2) USB input/output buffer

Parameter	Symbol	Conditions	MIN.	TYP.	MAX.	Unit
High level output voltage	V_{OH}	14.2 kΩ R_H for GND	2.8		3.6	V
Low level output voltage	V_{OL}	1.42 kΩ R_L for 3.6 V	0		0.3	V
Differential common mode range	V_{CM}	Includes V_{DI} range Absolute value of (D+) – (D–) 0.2 Vmin	0.8		2.5	V
Data line leakage current in input pin high impedance state	I_{LO}	$0\text{ V} < V_{IN} < 3.3\text{ V}$			±10	μA
Crossover output voltage	V_{CRS}		1.3		2.0	V

(3) 5 V output buffer

Parameter	Symbol	Conditions	MIN.	TYP.	MAX.	Unit
High level output voltage	V_{OH}	$I_{OH} = -6\text{ mA}$			2.4	V
Low level output voltage	V_{OL}	$I_{OH} = 6\text{ mA}$			0.4	V

(4) Open drain output buffer

Parameter	Symbol	Conditions	MIN.	TYP.	MAX.	Unit
Low level output voltage	V_{OL}	$I_{OL} = 6\text{ mA}$			0.4	V

AC Characteristics ($V_{DD} = 3.3\text{ V} \pm 0.3\text{ V}$, $T_A = 0\text{ to }+70^\circ\text{C}$)

(1) Full-speed output driver characteristics

Parameter	Symbol	Conditions	MIN.	TYP.	MAX.	Unit
Output rise time (FS) Output fall time (FS)	t_{FR}, t_{FF}	UD0, UD1 $C_L = 50\text{ pF}$, $T_A = 25^\circ\text{C}$, 10% to 90%	4		20	ns
Crossover output voltage	V_{CRS}		1.3		2.0	V
Driver output resistance	Z_{DRV}		28		44	Ω
Full-speed data rate	t_{FDRATE}	12Mbps $\pm 0.25\%$	11.97		12.03	Mbps
Differential driver jitter (FS)	t_{DJ1}	Continuous transition			± 3.5	ns
	t_{DJ2}	Pair transition			± 4.0	ns
Source jitter on SE0 transition from differential transition (FS)	t_{FDEOP}		-2		+5	ns
Receiver jitter (FS)	t_{JR1}	Continuous transition			± 18.5	ns
	t_{JR2}	Pair transition			± 9	ns
One-way propagation delay	t_{FPROP}				26	ns
EOP source SE0 interval	t_{FEOPT}		160		175	ns
EOP receiver SE0 interval	t_{FEOPR}	Accept as effective EOP.	82			ns
SE0 time interval on differential transition	t_{FST}				14	ns

(2) HUB repeater characteristics (Full-speed)

Parameter	Symbol	Conditions	MIN.	TYP.	MAX.	Unit
Output rise time (LS) Output fall time (LS)	t_r, t_f	D10 to D50, D11 to D51 $C_L = 50\text{ pF}$, $T_A = 25^\circ\text{C}$, 10% to 90%	4		20	ns
Differential data delay (LS)	t_{HDD1}	With cable			70	ns
	t_{HDD2}	Without cable			44	ns
Differential driver jitter (LS)	t_{HDJ1}	Continuous transition			± 3	ns
	t_{HDJ2}	Pair transition			± 1	ns
Data bit length distortion after SOP (LS)	t_{FSOP}				+5	ns
HUB EOP delay for t_{HDD1}	t_{FEOPD}		0		15	ns
EOP output width skew (LS)	t_{FHESK}				± 15	ns

(3) HUB event timing

Parameter	Symbol	Conditions	MIN.	TYP.	MAX.	Unit
Time to detect downstream port connection event (wake-up HUB)	t _{DCNN}		2.5		2000	μs
Time to detect downstream port connection event (suspend HUB)			2.5		12000	μs
Time to detect disconnect event at downstream port (wake-up HUB)	t _{DDIS}		2		2.5	μs
Time to detect disconnect event at downstream port (suspend HUB)			2		10000.0	μs
Period to drive resume at downstream port (from control HUB only)	t _{DRSMON}		20			ms
Time from detecting downstream resume to re-broadcasting	t _{URSM}				100	μs
Time to detect long K state from upstream	t _{URLK}		2.5		5.5	μs
Time to detect long SE0 from upstream	t _{URLSE0}		2.5		10000	μs
Period to repeat SE0 upstream	t _{URPSE0}				23	FS Bit time
Period to transmit SE0 upstream after EOF1	t _{UDEOP}	Optional			2	FS Bit time

(4) Device event timing

Parameter	Symbol	Conditions	MIN.	TYP.	MAX.	Unit
Time from internal power becoming effective until device pulls D+/D- above VIHZ (MIN.) (signal attach)	tSIGATT				100	ms
Time for USB system software to perform debounce after attach	tATTDB				100	ms
Time for which bus is continuously in idling state, maximum time device draws more power than suspend power	t2SUSP				10	ms
Maximum value of average suspend time	tSUSAVGI				1	s
Period to drive upstream on resume	tDRSMUP		1		15	ms
Resume restore period	tRSMRCY	Supplied by USB system software	10			ms
Time to detect reset from upstream	tDETRST	Same as tURLSE0	2.5		10000	μs
Reset restore time	tRSTRCY				10	ms
Inter-packet delay	tIPD		2			Bit time
Inter-packet delay of device responses using detachable cable	tPDRSP1				6.5	Bit time
Inter-packet delay of device responses using captive cable	tPDRSP2				7.5	Bit time
SetAddress() completion time	tDSETADDR				50	ms
Time to complete standard request without data stage	tDRQCPLTND				50	ms
Time to deliver first and subsequent data (excluding last) for standard request	tDRETDATA1				500	ms
Time to deliver last data for standard request	tDRETDATAN				50	ms

Measurement Conditions

(1) Differential data jitter

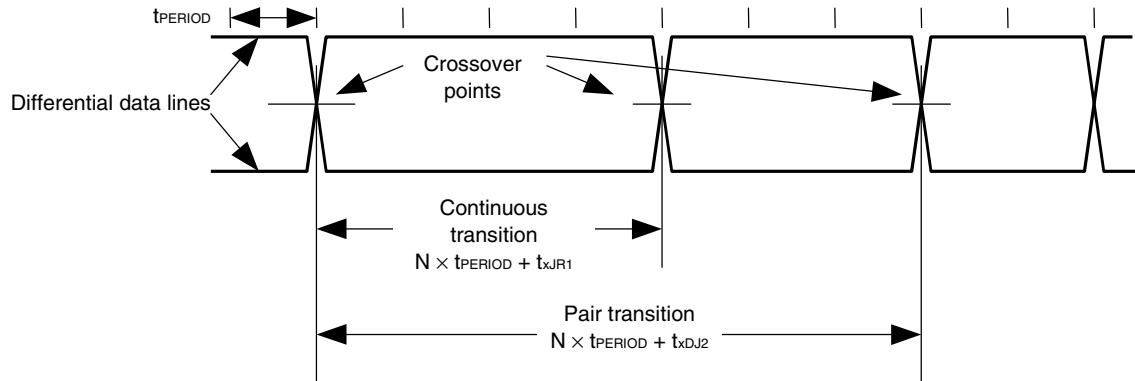

(2) EOP transition skew and EOP length differential

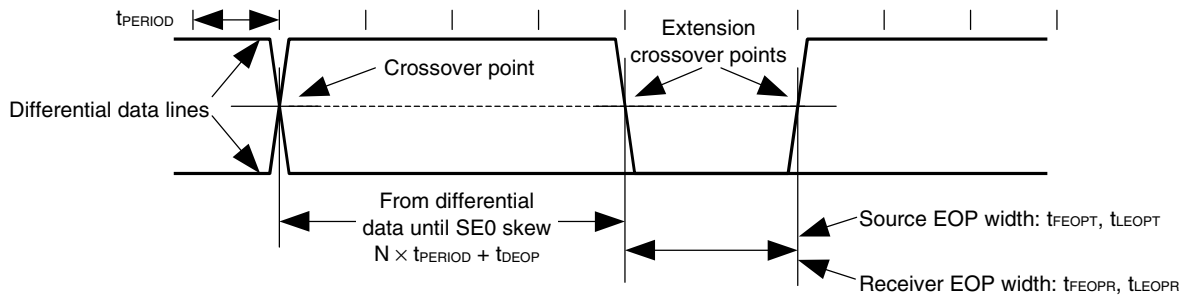

(3) Permissible range of receiver jitter

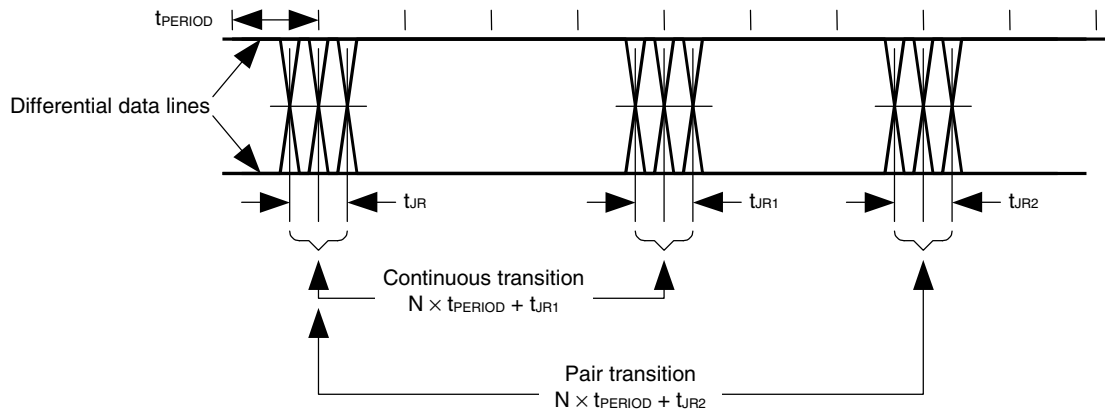

Remark t_{PERIOD} is the data rate of a receiver that has the range that is defined in paragraph 7.1.11 of USB Specification Revision 1.1.

(4) HUB differential delay, differential jitter, and SOP distortion

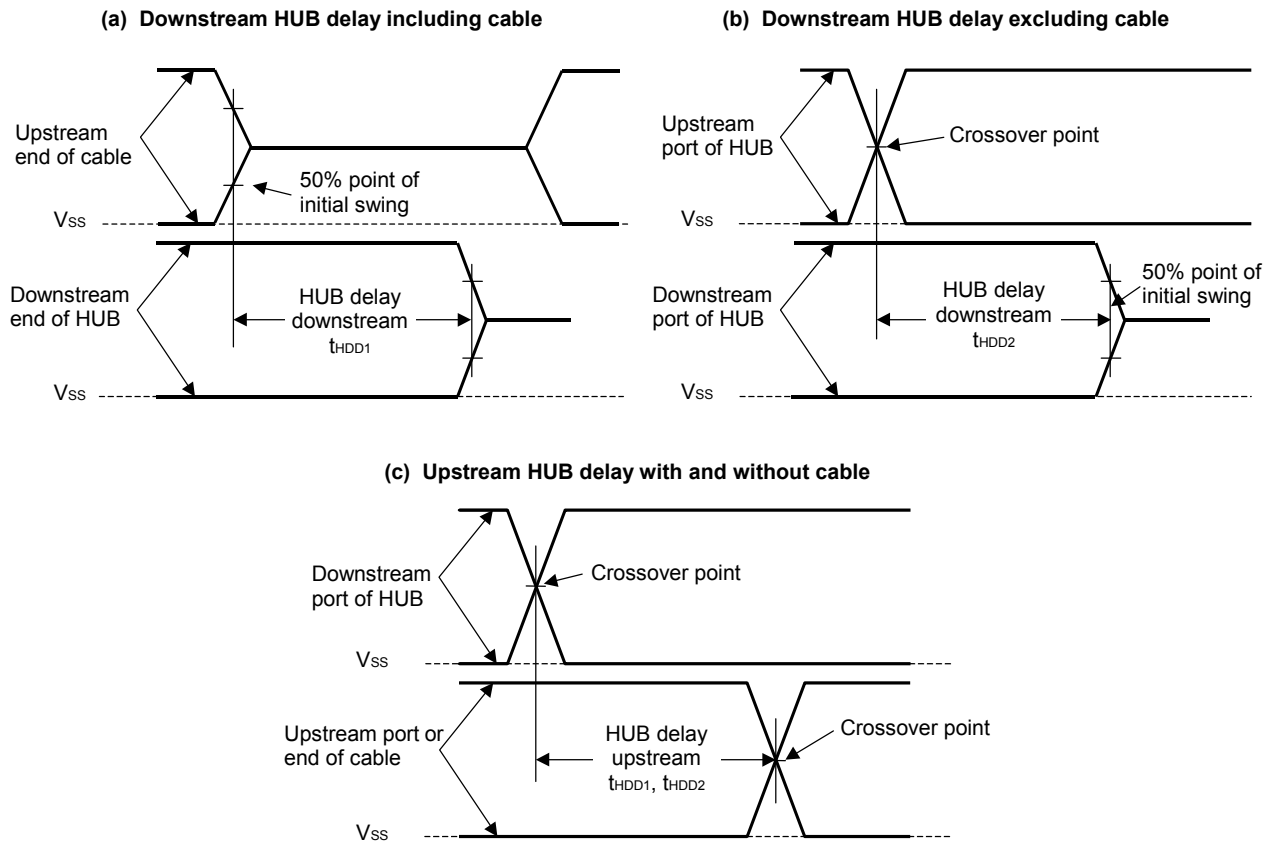

HUB operation jitter:

$t_{HDJ1} = t_{HDDx}(J) - t_{HDDx}(K)$ or $t_{HDDx}(K) - t_{HDDx}(J)$ Continuous transition

$t_{HDJ2} = t_{HDDx}(J) - t_{HDDx}(J)$ or $t_{HDDx}(K) - t_{HDDx}(K)$ Pair transition

Bit after SOP width distortion (same as data jitter of next transition of SOP):

$t_{FSOP} = t_{HDDx}(\text{next J}) - t_{HDDx}(\text{SOP})$

The low-speed timing below is determined by the same method.

t_{LHDD} , t_{LDHJ1} , t_{LDJH2} , t_{LUHJ1} , t_{LUJH2} , and t_{LSOP}

(5) HUB EOP delay and EOP skew

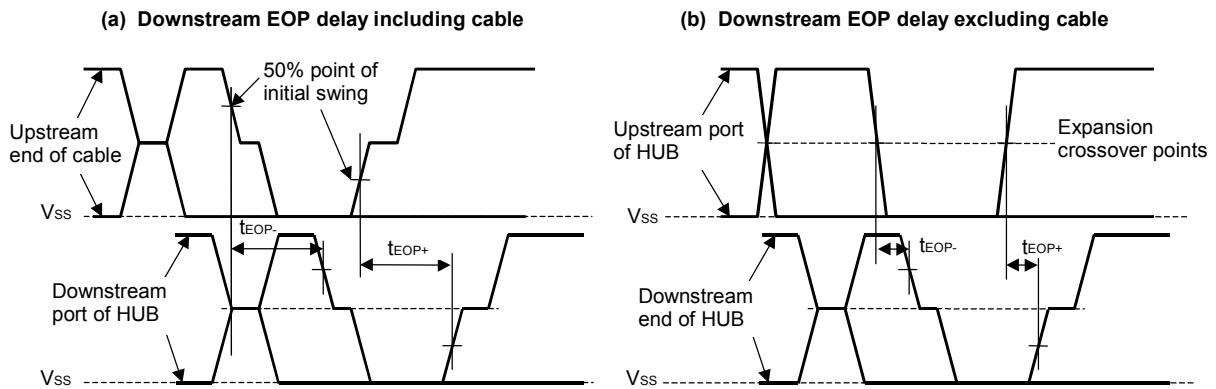

(c) Downstream EOP delay with and without cable

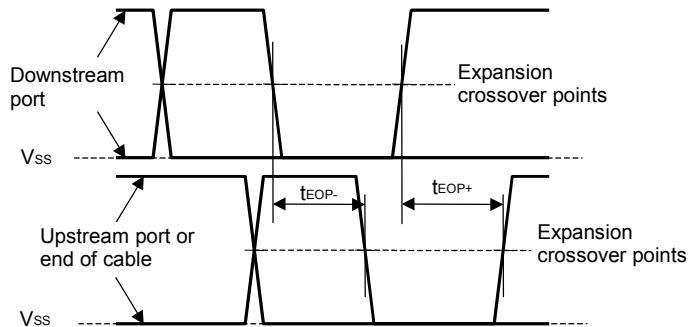

EOP delay:
 $t_{EOPD} = t_{EOPy} - t_{EHDDx}$
 (t_{EOPy} means apply this expression to t_{EOP-} and t_{EOP+} .)

EOP skew:
 $t_{HESK} = t_{EOP+} - t_{EOP-}$

The low speed timing below is determined by the same method.
 t_{LEOPD} , t_{LHESK}

CS Timing Chart

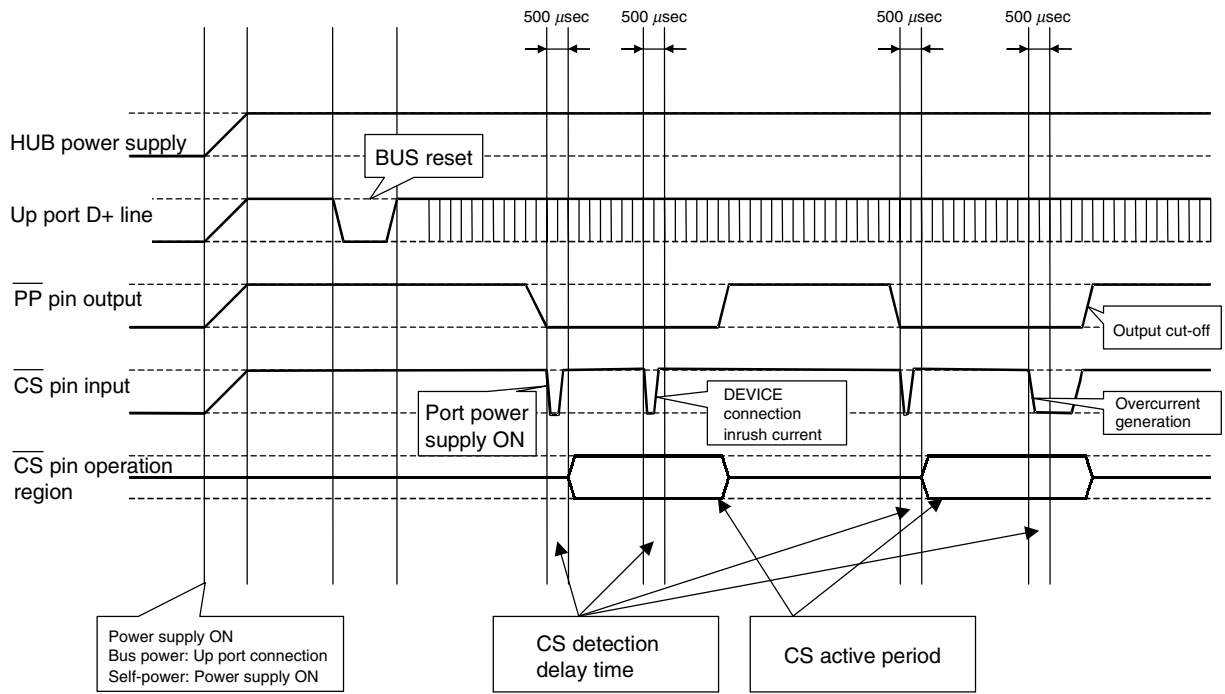

Remark The active period of the \overline{CS} pin is in effect only when the \overline{PP} pin is ON.
 There is a delay time of approximately 500 μsec duration at the \overline{CS} pin.

4. PACKAGE DRAWINGS

★ 42-PIN PLASTIC SDIP (15.24mm(600))

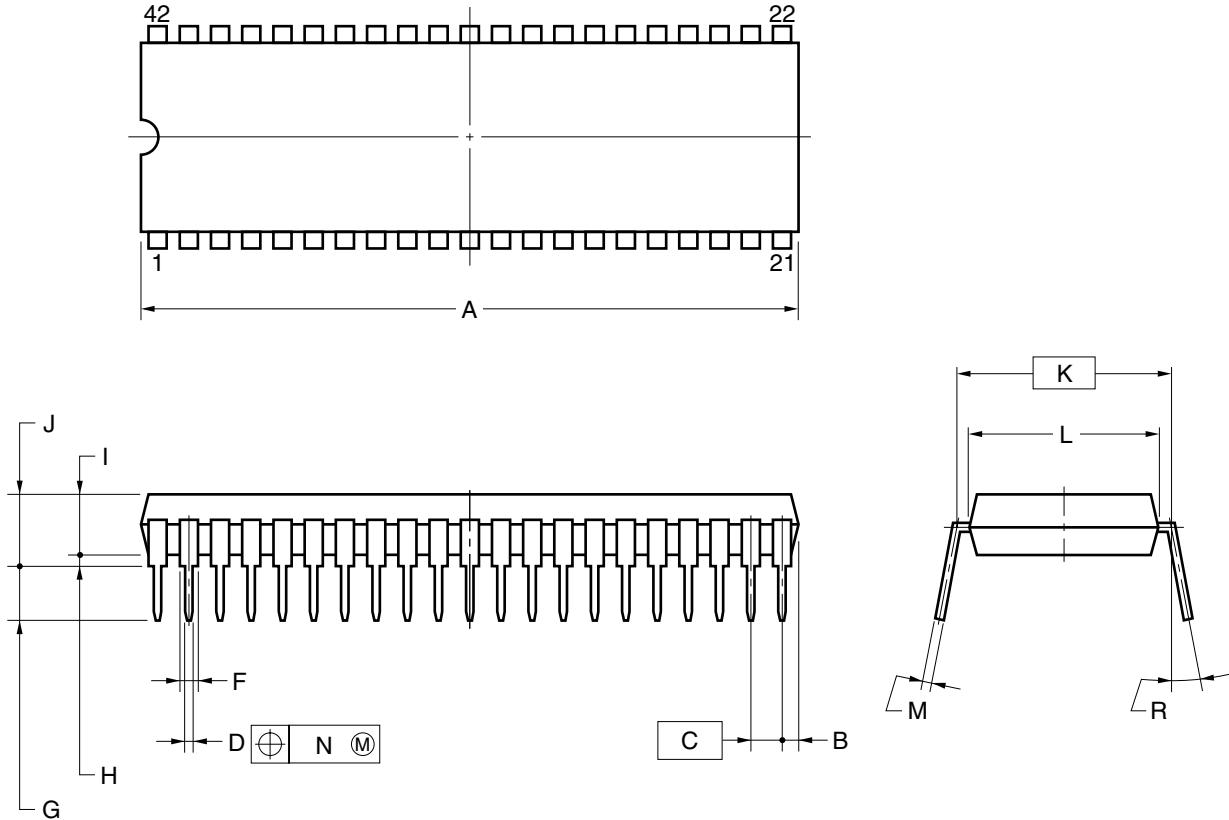

NOTES

1. Each lead centerline is located within 0.17 mm of its true position (T.P.) at maximum material condition.
2. Item "K" to center of leads when formed parallel.

ITEM	MILLIMETERS
A	39.13 MAX.
B	1.78 MAX.
C	1.778 (T.P.)
D	0.50±0.10
F	0.9 MIN.
G	3.2±0.3
H	0.51 MIN.
I	4.31 MAX.
J	5.08 MAX.
K	15.24 (T.P.)
L	13.2
M	0.25 ^{+0.10} _{-0.05}
N	0.17
R	0-15°

P42C-70-600A-2

★ 44-PIN PLASTIC QFP (10x10)

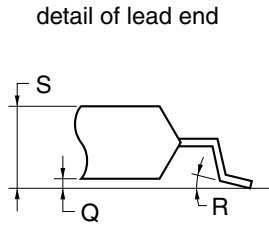
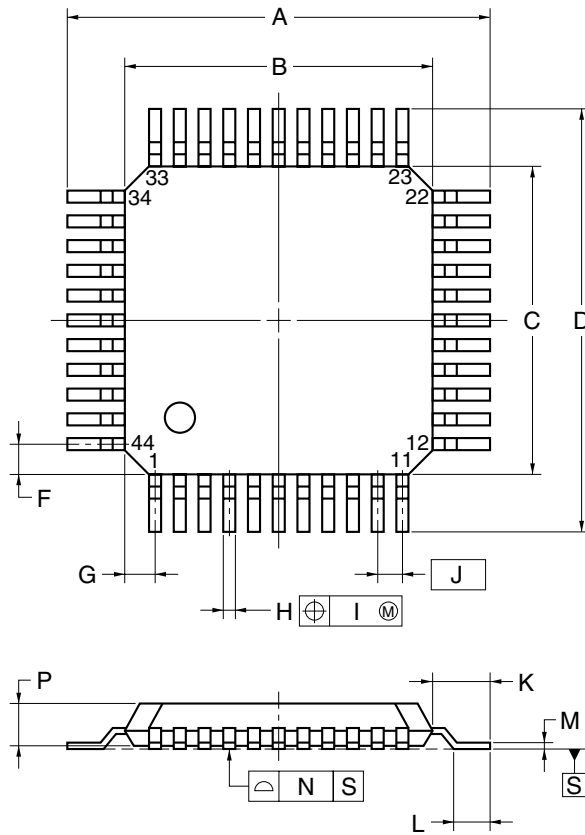

NOTE

Each lead centerline is located within 0.15 mm of its true position (T.P.) at maximum material condition.

ITEM	MILLIMETERS
A	13.6±0.4
B	10.0±0.2
C	10.0±0.2
D	13.6±0.4
F	1.0
G	1.0
H	0.35 ^{+0.08} _{-0.07}
I	0.15
J	0.8 (T.P.)
K	1.8±0.2
L	0.8±0.2
M	0.17 ^{+0.08} _{-0.07}
N	0.10
P	2.7±0.1
Q	0.1±0.1
R	5°±5°
S	3.0 MAX.

P44GB-80-3B4-5

5. RECOMMENDED SOLDERING CONDITIONS

The μPD72012 should be soldered and mounted under the following recommended conditions. For the details of the recommended soldering conditions, refer to the document **Semiconductor Device Mounting Technology Manual (C10535E)**.

For soldering methods and conditions other than those recommended below, contact your NEC sales representative.

Surface mount type soldering conditions

μPD72012GB-XXX-3B4: 44-pin plastic QFP (10 × 10)

Soldering Method	Soldering Conditions	Recommended Condition Code
Infrared reflow	Peak package temperature: 235°C, Time: 30 sec. max. (210°C min.), Count: three times or less	IR35-00-3
VPS	Peak package temperature: 215°C, Time: 40 sec. max. (200°C min.), Count: three times or less	VP15-00-3
Wave soldering	Solder bath temperature: 260°C max., Time: 10 sec. max., Count: once, Preheating temperature: 120°C max. (package surface temperature)	WS60-00-1
Pin partial heating	Pin temperature: 300°C max., Time: 3 sec. max. (per device side)	—

Caution Avoid using different soldering methods together. (However, the pin partial heating method is excluded.)

Through-hole type soldering conditions

μPD72012CU-XXX: 42-pin plastic SDIP (15.24 mm (600))

Soldering Method	Soldering Conditions
Wave soldering (pins only)	Solder bath temperature: 260°C max., Time: 10 sec. max.
Pin partial heating	Pin temperature: 300°C max., Time: 3 sec. max. (per pin)

Caution Apply wave soldering only to the pins, and exercise care that solder does not directly contact the package.

NOTES FOR CMOS DEVICES**① PRECAUTION AGAINST ESD FOR SEMICONDUCTORS**

Note:

Strong electric field, when exposed to a MOS device, can cause destruction of the gate oxide and ultimately degrade the device operation. Steps must be taken to stop generation of static electricity as much as possible, and quickly dissipate it once, when it has occurred. Environmental control must be adequate. When it is dry, humidifier should be used. It is recommended to avoid using insulators that easily build static electricity. Semiconductor devices must be stored and transported in an anti-static container, static shielding bag or conductive material. All test and measurement tools including work bench and floor should be grounded. The operator should be grounded using wrist strap. Semiconductor devices must not be touched with bare hands. Similar precautions need to be taken for PW boards with semiconductor devices on it.

② HANDLING OF UNUSED INPUT PINS FOR CMOS

Note:

No connection for CMOS device inputs can be cause of malfunction. If no connection is provided to the input pins, it is possible that an internal input level may be generated due to noise, etc., hence causing malfunction. CMOS devices behave differently than Bipolar or NMOS devices. Input levels of CMOS devices must be fixed high or low by using a pull-up or pull-down circuitry. Each unused pin should be connected to V_{DD} or GND with a resistor, if it is considered to have a possibility of being an output pin. All handling related to the unused pins must be judged device by device and related specifications governing the devices.

③ STATUS BEFORE INITIALIZATION OF MOS DEVICES

Note:

Power-on does not necessarily define initial status of MOS device. Production process of MOS does not define the initial operation status of the device. Immediately after the power source is turned ON, the devices with reset function have not yet been initialized. Hence, power-on does not guarantee out-pin levels, I/O settings or contents of registers. Device is not initialized until the reset signal is received. Reset operation must be executed immediately after power-on for devices having reset function.

The export of this product from Japan is prohibited without governmental license. To export or re-export this product from a country other than Japan may also be prohibited without a license from that country. Please call an NEC sales representative.

- **The information in this document is current as of April, 2001. The information is subject to change without notice. For actual design-in, refer to the latest publications of NEC's data sheets or data books, etc., for the most up-to-date specifications of NEC semiconductor products. Not all products and/or types are available in every country. Please check with an NEC sales representative for availability and additional information.**
- No part of this document may be copied or reproduced in any form or by any means without prior written consent of NEC. NEC assumes no responsibility for any errors that may appear in this document.
- NEC does not assume any liability for infringement of patents, copyrights or other intellectual property rights of third parties by or arising from the use of NEC semiconductor products listed in this document or any other liability arising from the use of such products. No license, express, implied or otherwise, is granted under any patents, copyrights or other intellectual property rights of NEC or others.
- Descriptions of circuits, software and other related information in this document are provided for illustrative purposes in semiconductor product operation and application examples. The incorporation of these circuits, software and information in the design of customer's equipment shall be done under the full responsibility of customer. NEC assumes no responsibility for any losses incurred by customers or third parties arising from the use of these circuits, software and information.
- While NEC endeavours to enhance the quality, reliability and safety of NEC semiconductor products, customers agree and acknowledge that the possibility of defects thereof cannot be eliminated entirely. To minimize risks of damage to property or injury (including death) to persons arising from defects in NEC semiconductor products, customers must incorporate sufficient safety measures in their design, such as redundancy, fire-containment, and anti-failure features.
- NEC semiconductor products are classified into the following three quality grades:
"Standard", "Special" and "Specific". The "Specific" quality grade applies only to semiconductor products developed based on a customer-designated "quality assurance program" for a specific application. The recommended applications of a semiconductor product depend on its quality grade, as indicated below. Customers must check the quality grade of each semiconductor product before using it in a particular application.
"Standard": Computers, office equipment, communications equipment, test and measurement equipment, audio and visual equipment, home electronic appliances, machine tools, personal electronic equipment and industrial robots
"Special": Transportation equipment (automobiles, trains, ships, etc.), traffic control systems, anti-disaster systems, anti-crime systems, safety equipment and medical equipment (not specifically designed for life support)
"Specific": Aircraft, aerospace equipment, submersible repeaters, nuclear reactor control systems, life support systems and medical equipment for life support, etc.

The quality grade of NEC semiconductor products is "Standard" unless otherwise expressly specified in NEC's data sheets or data books, etc. If customers wish to use NEC semiconductor products in applications not intended by NEC, they must contact an NEC sales representative in advance to determine NEC's willingness to support a given application.

(Note)

- (1) "NEC" as used in this statement means NEC Corporation and also includes its majority-owned subsidiaries.
- (2) "NEC semiconductor products" means any semiconductor product developed or manufactured by or for NEC (as defined above).