

General Description

DCX100NS is best suited for applications where the load needs to be turned on and off using control circuits like micro-controllers, comparators etc. particularly at a point of load. It features a discrete PNP pass transistor which can support continuous maximum current up to 100 mA. It also contains an NPN transistor which can be used as a control switch and also it can be biased using higher supply. The component devices can be used as part of a circuit or as stand alone discrete devices.

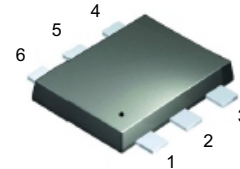

Fig. 1: SOT-563

Features

- Built in Biasing Resistors
- Epitaxial Planar Die Construction
- Lead Free By Design/ROHS Compliant (Note 1)**
- "Green" Device (Note 2)**
- Ideally Suited for Automated Assembly Processes**

Mechanical Data

- Case: SOT-563
- Case Material: Molded Plastic. "Green Molding" Compound. UL Flammability Classification Rating 94V-0
- Moisture Sensitivity: Level 1 per J-STD-020C
- Terminal Connections: See Fig. 2
- Terminals: Finish - Matte Tin annealed over Alloy 42 leadframe. Solderable per MIL-STD-202, Method 208
- Marking & Type Code Information: See Page 5
- Ordering Information: See Page 5 and 6
- Weight: 0.005 grams (approximate)

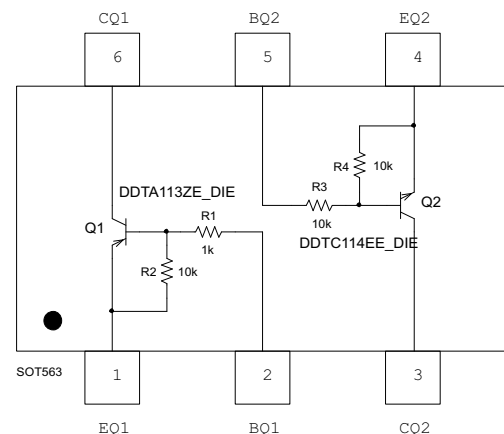

Fig. 2: Schematic and Pin Configuration

Sub-Component P/N	Reference	Device Type	R1 (NOM)	R2 (NOM)	R3, R4 (NOM)	Figure
DDTA113ZE_DIE	Q1	PNP	1K	10K		2
DDTC114EE_DIE	Q2	NPN			10K	2

Maximum Ratings: Total Device @ T_A = 25 C unless otherwise specified

Characteristic	Symbol	Value	Unit
Power Dissipation (Note 3)	P _d	150	mW
Thermal Resistance, Junction to Ambient Air (Note 3)	R _{JA}	833	C/W
Operating and Storage Junction Temperature Range	T _j , T _{stg}	-55 to +150	°C
Collector Current (using PNP as Pass Transistor)	I _{C(max)}	100	mA

Sub-Component Device - Pre-Biased PNP Transistor @ T_A = 25 C unless otherwise specified

Characteristic	Symbol	Value	Unit
Supply Voltage	V _{CC}	-50	V
Input Voltage	V _{in}	+5 to -10	V
Output Current	I _c	-100	mA

- Notes:
1. No purposefully added lead.
 2. Diodes Inc.'s "Green" policy can be found on our website at http://www.diodes.com/products/lead_free/index.php.
 3. Device mounted on FR-4 PCB, 1 inch x 0.85 inch x 0.062 inch; please see page 6 or as per Diodes Inc. suggested pad layout document AP02001 on our website at <http://www.diodes.com/datasheets/ap02001.pdf>.

Sub-Component Device - Pre-Biased NPN Transistor @ $T_A = 25\text{ C}$ unless otherwise specified

Characteristic	Symbol	Value	Unit
Supply Voltage	V_{CC}	50	V
Input Voltage	V_{in}	-10 to +40	V
Output Current	I_c	50	mA

Electrical Characteristics: Pre-Biased PNP Transistor @ $T_A = 25\text{ C}$ unless otherwise specified

Characteristic	Symbol	Min	Typ	Max	Unit	Test Condition
Input Voltage	$V_{I(off)}$	-0.3			V	$V_{CC} = -5V, I_O = -100\mu A$
	$V_{I(on)}$			-3.0	V	$V_O = -0.3V, I_O = -20mA$
Output Voltage	$V_{O(on)}$		-0.1	-0.3	V	$I_O/I_I = -10mA / -0.5mA$
Input Current	I_I			-7.2	mA	$V_I = -5V$
Output Current	$I_{O(off)}$			-0.5	μA	$V_{CC} = -50V, V_I = 0V$
DC Current Gain	G_I	33				$V_O = -5V, I_O = -5mA$
Input Resistor Tolerance	R1	-30		+30	%	
Resistor Ratio Tolerance	R2/R1	0.8	1	1.2	%	
Gain-Bandwidth Product	f_T		250		MHz	$V_{CE} = -10V, I_E = -5mA, f = 100\text{ MHz}$

Electrical Characteristics: Pre-Biased NPN Transistor @ $T_A = 25\text{ C}$ unless otherwise specified

Characteristic	Symbol	Min	Typ	Max	Unit	Test Condition
Input Voltage	$V_{I(off)}$	0.5	1.18		V	$V_{CC} = 5V, I_O = 100\mu A$
	$V_{I(on)}$		1.85	3	V	$V_O = 0.3V, I_O = 10mA$
Output Voltage	$V_{O(on)}$		0.1	0.3	V	$I_O/I_I = 10mA / 0.5mA$
Input Current	I_I			0.88	mA	$V_I = 5V$
Output Current	$I_{O(off)}$			0.5	μA	$V_{CC} = 50V, V_I = 0V$
DC Current Gain	G_I	30				$V_O = 5V, I_O = 5mA$
Input Resistor Tolerance	R1	-30		+30	%	
Resistor Ratio Tolerance	R2/R1	0.8	1	1.2	%	
Gain-Bandwidth Product	f_T		250		MHz	$V_{CE} = 10V, I_E = 5mA, f = 100\text{ MHz}$

Typical Characteristics @ $T_{amb} = 25\text{ C}$ unless otherwise specified

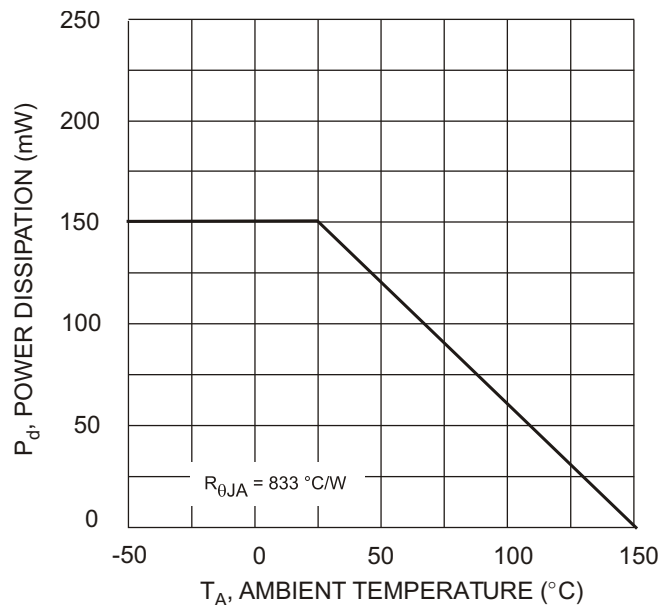

Fig. 3 Power Derating Curve (Total Device)

Characteristics Curves of PNP Transistor (Q1) @ $T_{amb} = 25\text{ C}$ unless otherwise specified

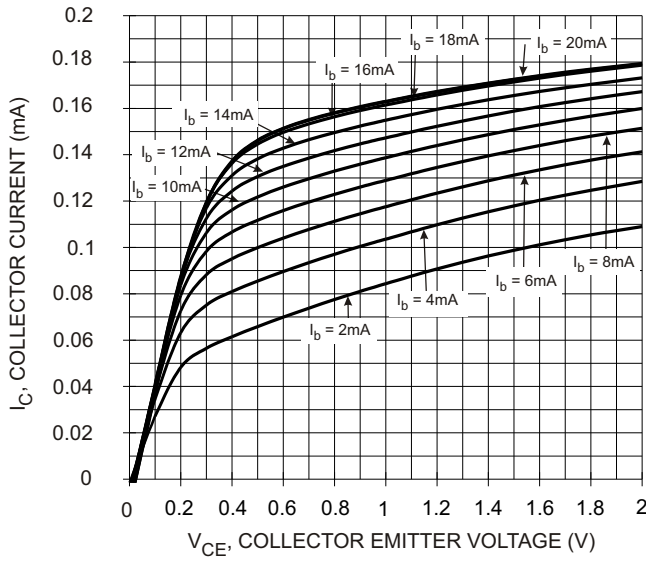

Fig. 4 $V_{CE(SAT)}$ vs. I_C

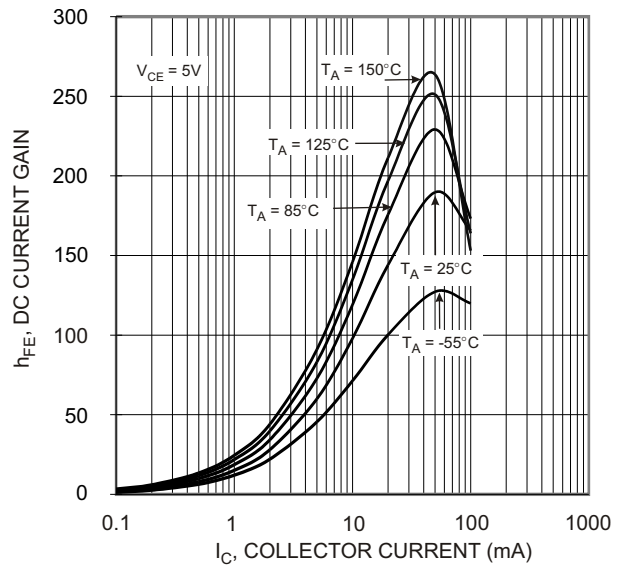

Fig. 5 DC Current Gain

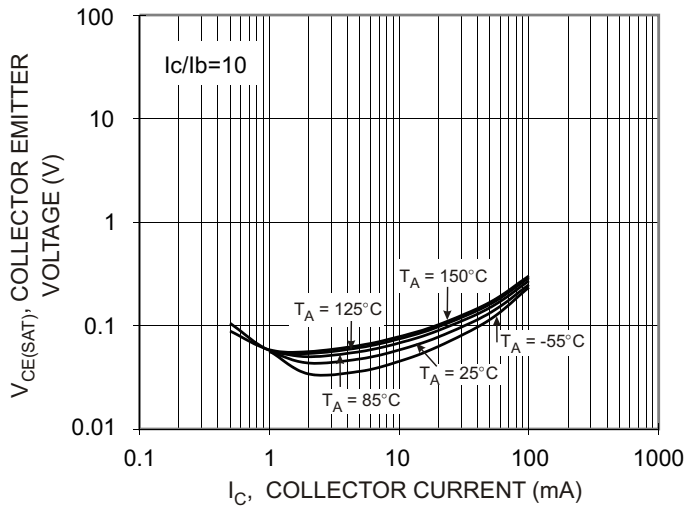

Fig. 6 $V_{CE(SAT)}$ vs I_C

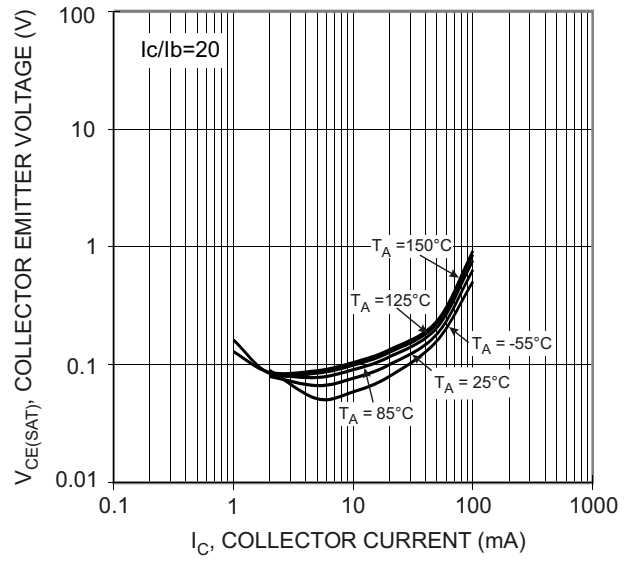

Fig. 7 $V_{CE(SAT)}$ vs I_C

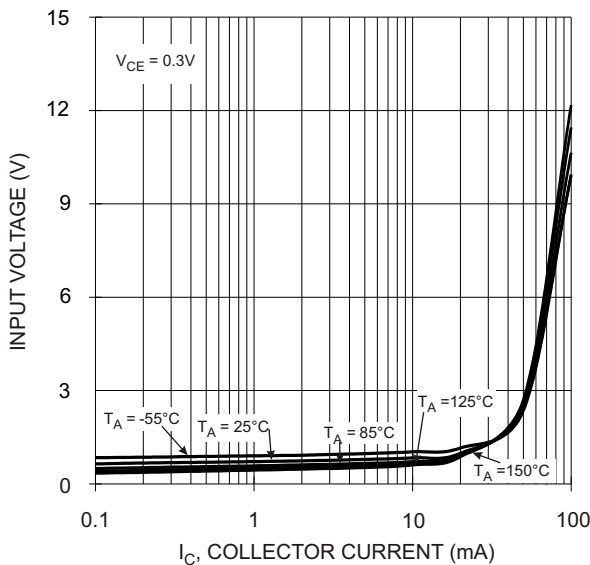

Fig. 8 Input Voltage vs. Output Current

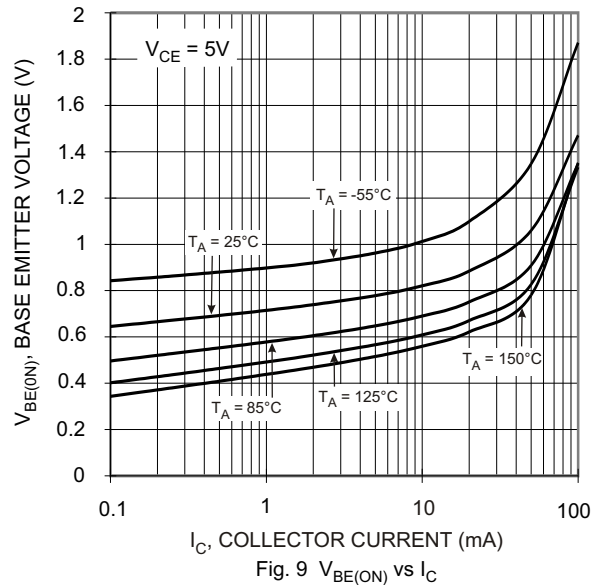

Fig. 9 $V_{BE(ON)}$ vs I_C

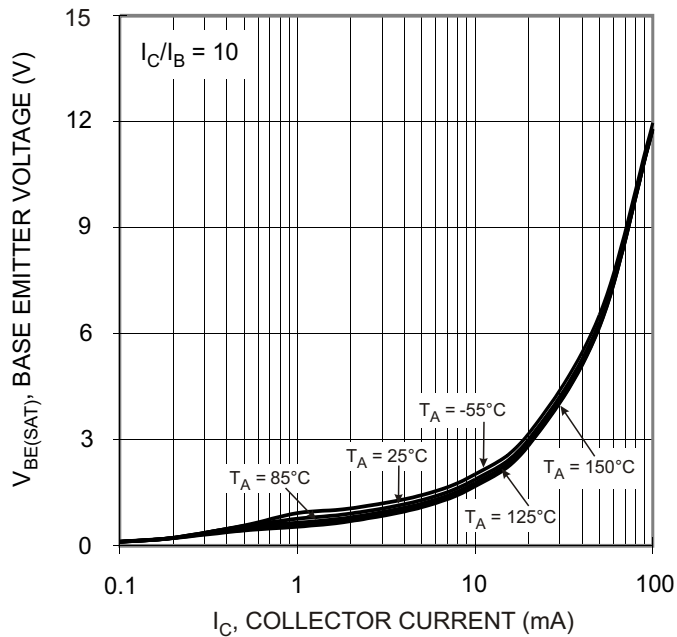

Fig. 10 $V_{BE(SAT)}$ vs I_C

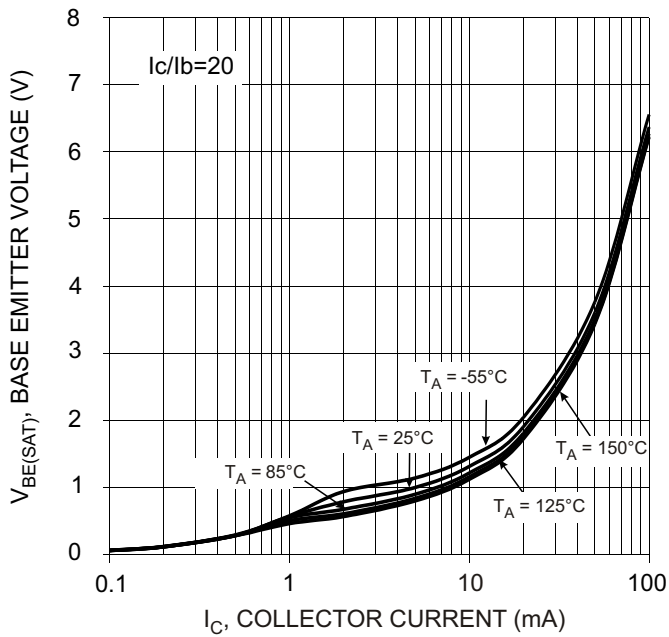

Fig. 11 $V_{BE(SAT)}$ vs I_C

Characteristics Curves of NPN Transistor (Q2)

@ $T_{amb} = 25^\circ\text{C}$ unless otherwise specified

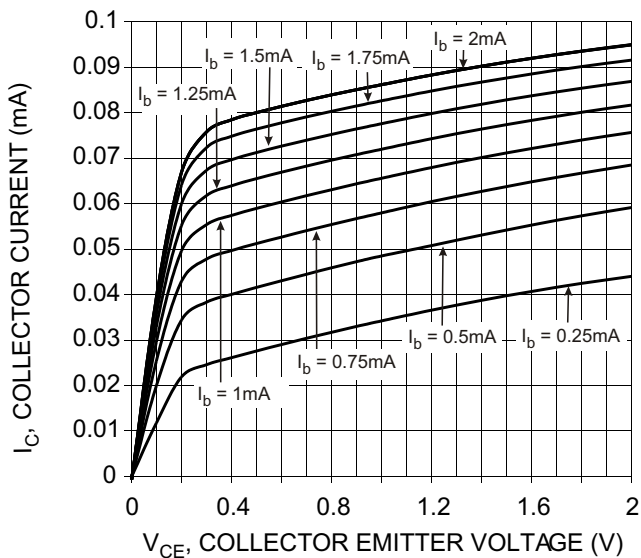

Fig. 12 V_{CE} vs I_C

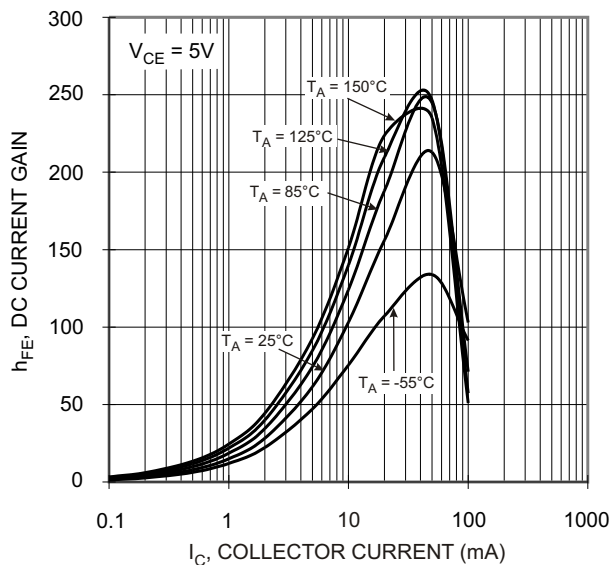

Fig. 13 DC Current Gain

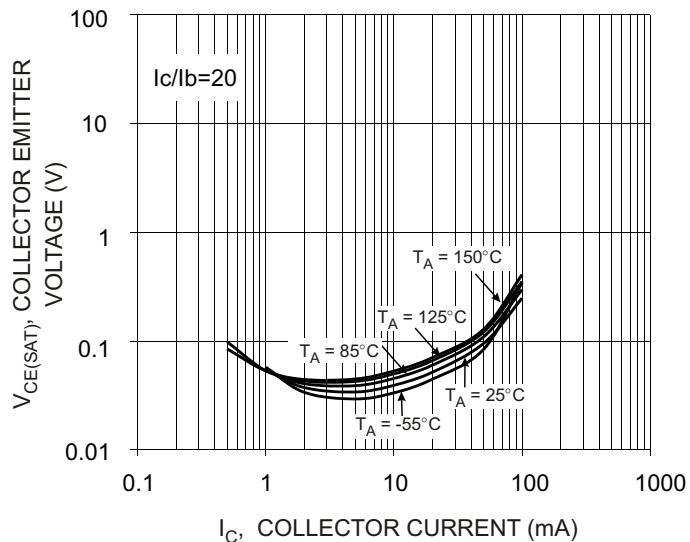

Fig. 14 $V_{CE(SAT)}$ vs I_C

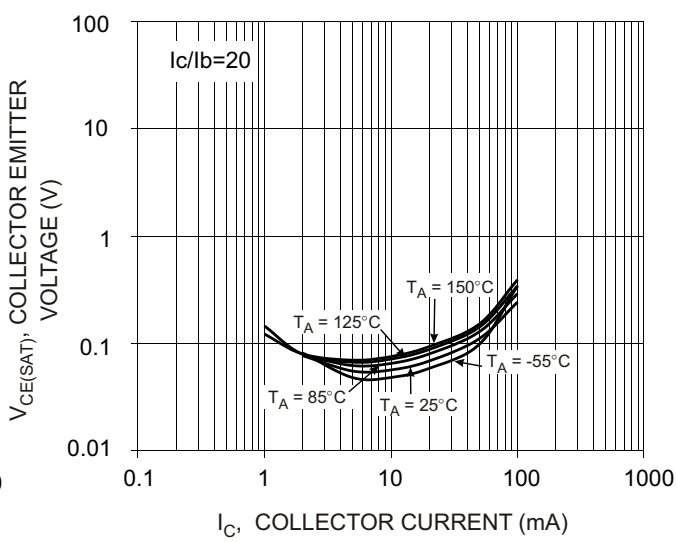

Fig. 15 $V_{CE(SAT)}$ vs I_C

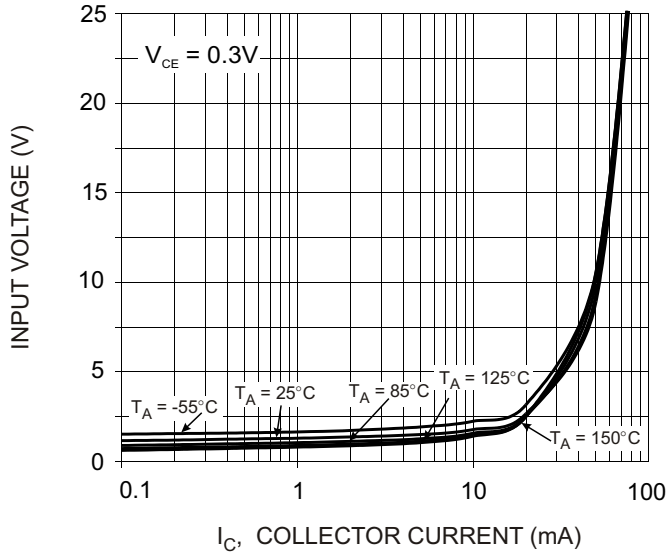

Fig. 16 Input Voltage vs Output Current

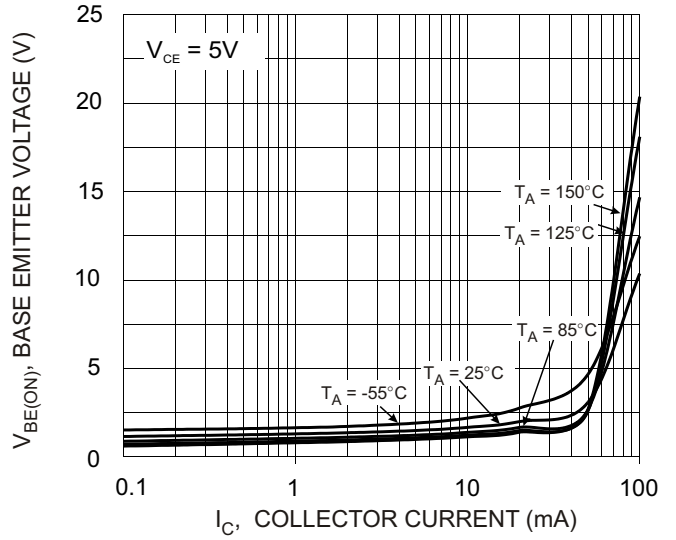

Fig. 17 V_{BE(ON)} vs I_C

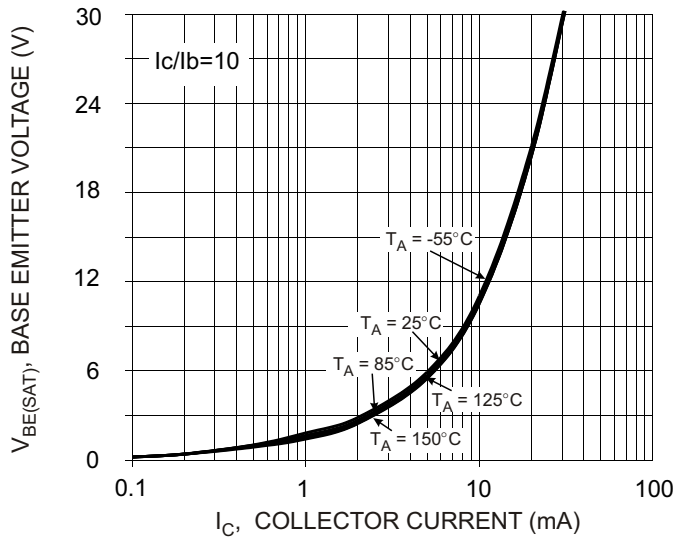

Fig. 18 V_{BE(SAT)} vs I_C

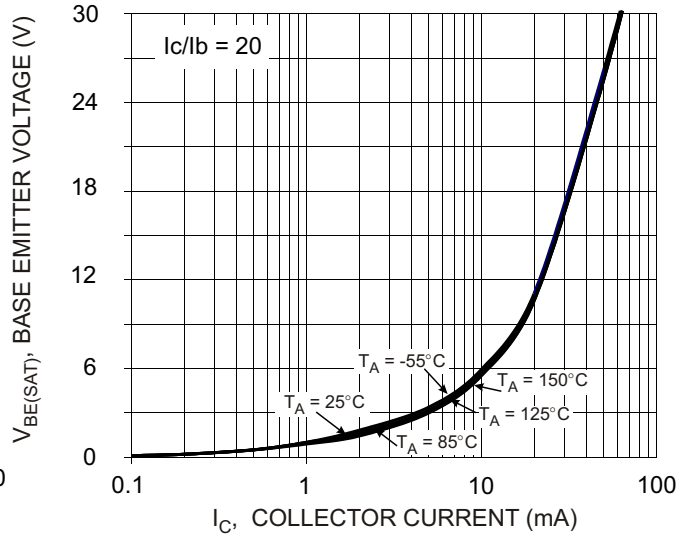

Fig. 19 V_{BE(SAT)} vs I_C

Ordering Information (Note 4)

Device	Marking Code	Packaging	Shipping
DCX100NS-7	C01	SOT-563	3000/Tape & Reel

Notes: 4. For Packaging Details, please see page 6 or go to our website at <http://www.diodes.com/datasheets/ap02007.pdf>.

Marking Information

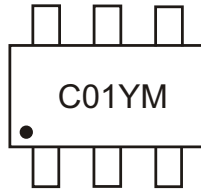

C01 = Product Type Marking Code
 YM = Date Code Marking
 Y = Year e.g., T = 2006
 M = Month e.g., 9 = September

Fig. 20

Date Code Key

Year	2005	2006	2007	2008	2009	2010	2011	2012
Code	S	T	U	V	W	X	Y	Z

Month	Jan	Feb	March	Apr	May	Jun	Jul	Aug	Sep	Oct	Nov	Dec
Code	1	2	3	4	5	6	7	8	9	O	N	D

Mechanical Details

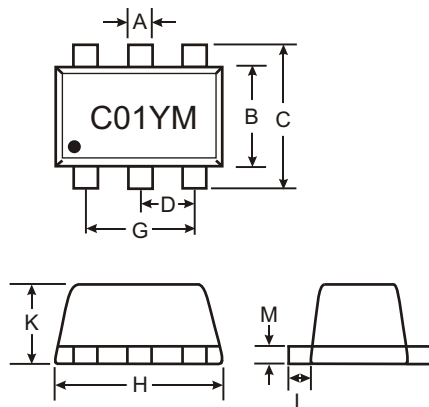

Fig. 21

SOT-563			
Dim	Min	Max	Typ
A	0.15	0.3	0.25
B	1.1	1.25	1.2
C	1.55	1.7	1.6
D	0.5		
G	0.90	1.1	1.00
H	1.5	1.7	1.6
K	0.56	0.6	0.6
L	0.15	0.25	0.2
M	0.1	0.18	0.11
All Dimensions in mm			

Suggested Pad Layout: (Based on IPC-SM-782)

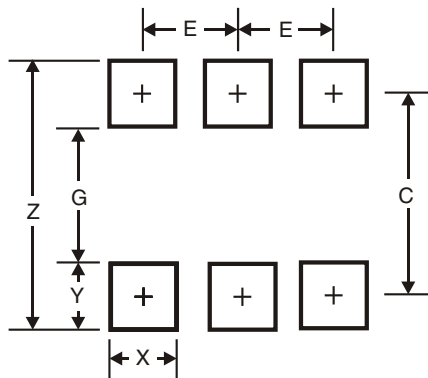

Fig. 22

Figure 22 Dimensions	SOT-563
Z	2.2
G	1.2
X	0.375
Y	0.5
C	1.7
E	0.5

IMPORTANT NOTICE

Diodes Incorporated and its subsidiaries reserve the right to make modifications, enhancements, improvements, corrections or other changes without further notice to any product herein. Diodes Incorporated does not assume any liability arising out of the application or use of any product described herein; neither does it convey any license under its patent rights, nor the rights of others. The user of products in such applications shall assume all risks of such use and will agree to hold Diodes Incorporated and all the companies whose products are represented on our website, harmless against all damages.

LIFE SUPPORT

Diodes Incorporated products are not authorized for use as critical components in life support devices or systems without the expressed written approval of the President of Diodes Incorporated.