

MOS INTEGRATED CIRCUIT
 μ PD4382162, 4382182, 4382322, 4382362**8M-BIT CMOS SYNCHRONOUS FAST SRAM**
PIPELINED OPERATION**Description**

The μ PD4382162 is a 524,288-word by 16-bit, the μ PD4382182 is a 524,288-word by 18-bit, μ PD4382322 is a 262,144-word by 32-bit and the μ PD4382362 is a 262,144-word by 36-bit synchronous static RAM fabricated with advanced CMOS technology using N-channel four-transistor memory cell.

The μ PD4382162, μ PD4382182, μ PD4382322 and μ PD4382362 integrates unique synchronous peripheral circuitry, 2-bit burst counter and output buffer as well as SRAM core. All input registers are controlled by a positive edge of the single clock input (CLK).

The μ PD4382162, μ PD4382182, μ PD4382322 and μ PD4382362 are suitable for applications which require synchronous operation, high speed, low voltage, high density and wide bit configuration, such as cache and buffer memory.

ZZ has to be set LOW at the normal operation. When ZZ is set HIGH, the SRAM enters Power Down State ("Sleep"). In the "Sleep" state, the SRAM internal state is preserved. When ZZ is set LOW again, the SRAM resumes normal operation.

The μ PD4382162, μ PD4382182, μ PD4382322 and μ PD4382362 are packaged in 100-pin plastic LQFP with a 1.4 mm package thickness for high density and low capacitive loading.

Features

- 3.3 V (Chip) / 3.3 V or 2.5 V (I/O) Supply
 - Synchronous Operation
 - Internally self-timed Write control
 - Burst Read / Write: Interleaved Burst and Linear Burst Sequence
 - Fully Registered Inputs and Outputs for Pipelined operation
 - All Registers triggered off Positive Clock Edge
 - 3.3 V or 2.5 V LVTTTL Compatible: All Inputs and Outputs
 - Fast Clock Access Time: 3.8 ns (150 MHz), 4.2 ns (133 MHz)
 - Asynchronous Output Enable: /G
 - Burst Sequence Selectable: MODE
 - Sleep Mode: ZZ (ZZ = Open or Low: Normal Operation)
 - Separate Byte Write Enable: /BW1 - /BW4 (μ PD4382322 and μ PD4382362),
/BW1 - /BW2 (μ PD4382162 and μ PD4382182), /BWE
- Global Write Enable: /GW
- Three Chip Enables for Easy Depth Expansion
 - Common I/O Using Three State Outputs

The information in this document is subject to change without notice. Before using this document, please confirm that this is the latest version.
Not all devices/types available in every country. Please check with local NEC representative for availability and additional information.

Ordering Information

Part number	Access Time	Clock Frequency	Core Supply Voltage	I/O Interface	Package
μPD4382162GF-A67	3.8 ns	150 MHz	3.3 ± 0.165V	3.3V LVTTTL	100-pin plastic LQFP (14 x 20 mm)
μPD4382162GF-A75	4.2 ns	133 MHz			
μPD4382182GF-A67	3.8 ns	150 MHz			
μPD4382182GF-A75	4.2 ns	133 MHz			
μPD4382322GF-A67	3.8 ns	150 MHz			
μPD4382322GF-A75	4.2 ns	133 MHz			
μPD4382362GF-A67	3.8 ns	150 MHz			
μPD4382362GF-A75	4.2 ns	133 MHz			
μPD4382162GF-A67B	3.8 ns	150 MHz	3.3 ± 0.165V	2.5V LVTTTL	
μPD4382162GF-A75B	4.2 ns	133 MHz			
μPD4382182GF-A67B	3.8 ns	150 MHz			
μPD4382182GF-A75B	4.2 ns	133 MHz			
μPD4382322GF-A67B	3.8 ns	150 MHz			
μPD4382322GF-A75B	4.2 ns	133 MHz			
μPD4382362GF-A67B	3.8 ns	150 MHz			
μPD4382362GF-A75B	4.2 ns	133 MHz			

Pin Configuration (Marking Side)

/xxx indicates active low signal.

100-pin plastic LQFP (14 x 20 mm)
[μPD4382162GF, 4382182GF]

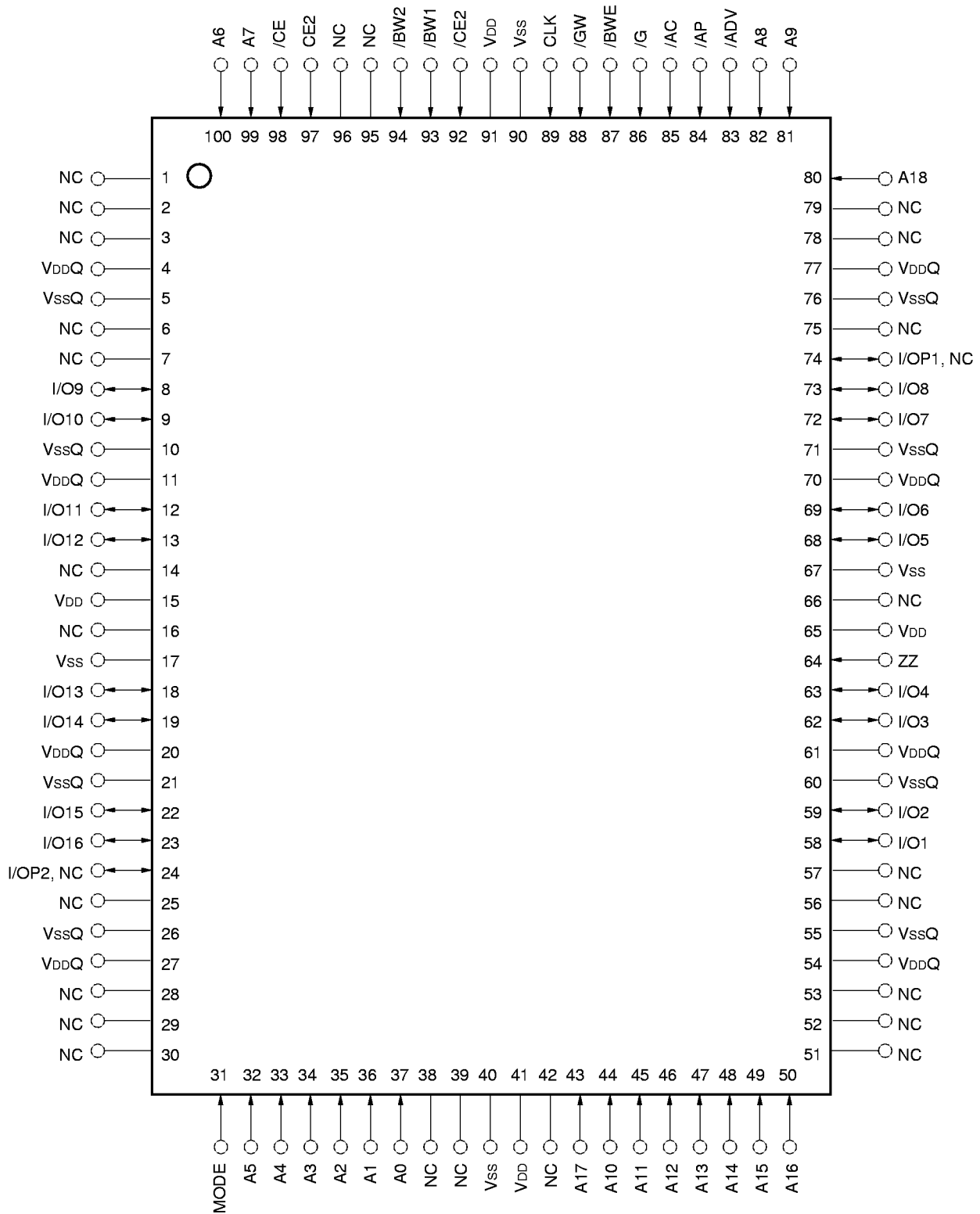

Pin Identification

[μPD4382162GF, 4382182GF]

Symbol	Pin No.	Description
A0 - A18	37, 36, 35, 34, 33, 32, 100, 99, 82, 81, 44, 45, 46, 47, 48, 49, 50, 43, 80	Synchronous Address Input
I/O1 - I/O16	58, 59, 62, 63, 68, 69, 72, 73, 8, 9, 12, 13, 18, 19, 22, 23	Synchronous Data In, Synchronous / Asynchronous Data Out
I/OP1 - I/OP2 NC ^{Note}	74, 24	Synchronous Data In (Parity), Synchronous / Asynchronous Data Out (Parity)
/ADV	83	Synchronous Burst Address Advance Input
/AP	84	Synchronous Address Status Processor Input
/AC	85	Synchronous Address Status Controller Input
/CE,CE2, /CE2	98, 97, 92	Synchronous Chip Enable Input
/BW1, /BW2, /BWE	93, 94, 87	Synchronous Byte Write Enable Input
/GW	88	Synchronous Global Write Input
/G	86	Asynchronous Output Enable Input
CLK	89	Clock Input
MODE	31	Asynchronous Burst Sequence Select Input Do not change state during normal operation
ZZ	64	Asynchronous Power Down State Input
V _{DD}	15, 41, 65, 91	Power Supply
V _{SS}	17, 40, 67, 90	Ground
V _{DDQ}	4, 11, 20, 27, 54, 61, 70, 77	Output Buffer Power Supply
V _{SSQ}	5, 10, 21, 26, 55, 60, 71, 76	Output Buffer Ground
NC	1, 2, 3, 6, 7, 14, 16, 25, 28, 29, 30, 38, 39, 42, 51, 52, 53, 56, 57, 66, 75, 78, 79, 95, 96	No Connection

Note No Connect (NC) is used in the μPD4382162GF.

I/OP1 - I/OP2 is used in the μPD4382182GF.

100-pin plastic LQFP (14 x 20 mm)
[μPD4382322GF, 4382362GF]

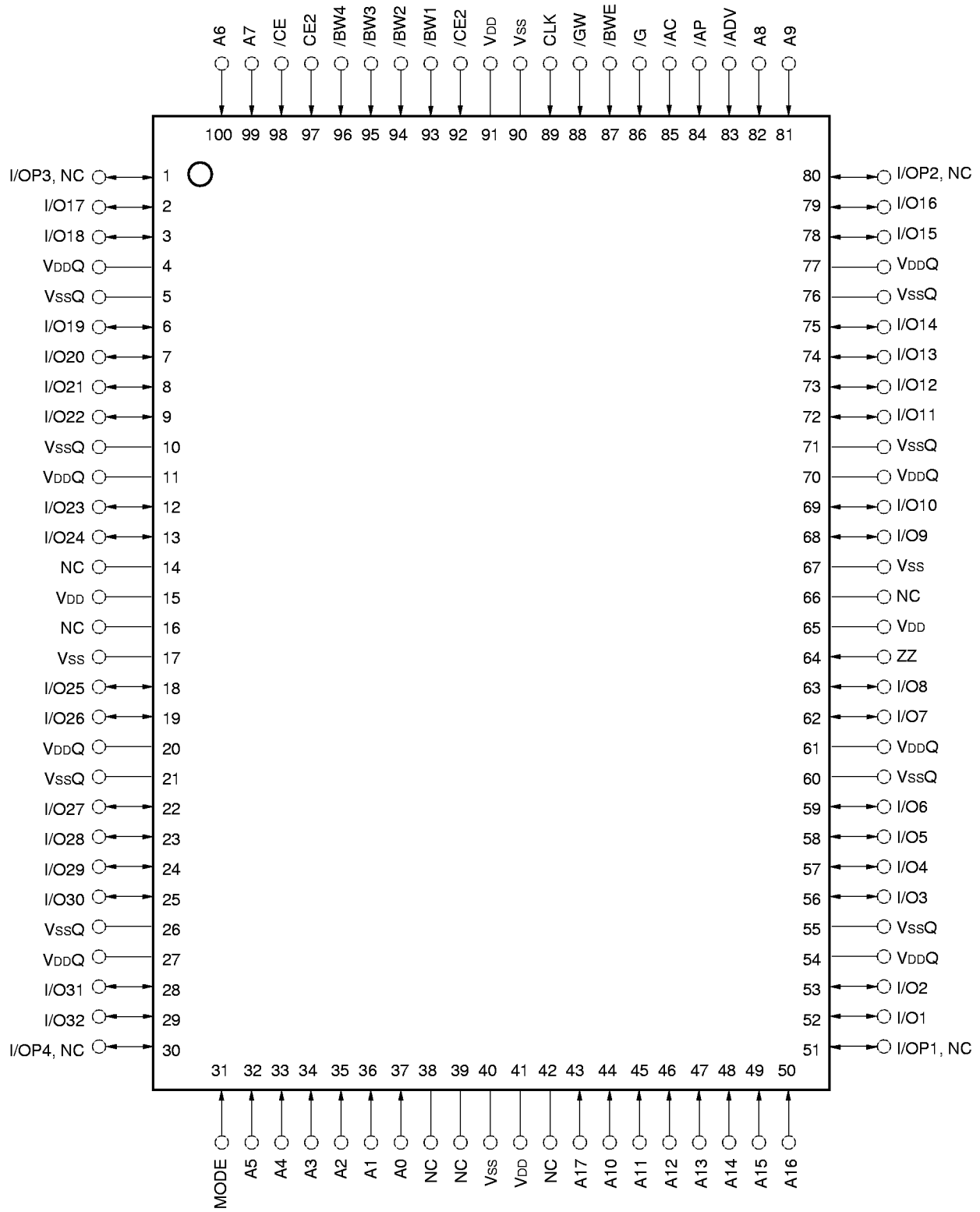

[μPD4382322GF, 4382362GF]

Symbol	Pin No.	Description
A0 - A17	37, 36, 35, 34, 33, 32, 100, 99, 82, 81, 44, 45, 46, 47, 48	Synchronous Address Input
I/O1 - I/O32	52, 53, 56, 57, 58, 59, 62, 63, 68, 69, 72, 73, 74, 75, 78, 79, 2, 3, 6, 7, 8, 9, 12, 13, 18, 19, 22, 23, 24, 25, 28, 29	Synchronous Data In, Synchronous / Asynchronous Data Out
I/OP1 - I/OP4 NC ^{Note}	1, 30, 51, 80	Synchronous Data In (Parity), Synchronous / Asynchronous Data Out (Parity)
/ADV	83	Synchronous Burst Address Advance Input
/AP	84	Synchronous Address Status Processor Input
/AC	85	Synchronous Address Status Controller Input
/CE, CE2, /CE2	98, 97, 92	Synchronous Chip Enable Input
/BWE1 - /BWE4, /BWE	93, 94, 95, 96, 87	Synchronous Byte Write Enable Input
/GW	88	Synchronous Global Write Input
/G	86	Asynchronous Output Enable Input
CLK	89	Clock Input
MODE	31	Asynchronous Burst Sequence Select Input Do not change state during normal operation
ZZ	64	Asynchronous Power Down State Input
VDD	15, 41, 65, 91	Power Supply
VSS	17, 40, 67, 90	Ground
VDDQ	4, 11, 20, 27, 54, 61, 70, 77	Output Buffer Power Supply
VSSQ	5, 10, 21, 26, 55, 60, 71, 76	Output Buffer Ground
NC	14, 16, 38, 39, 42, 43, 49, 50, 66	No Connection

Note No Connect (NC) is used in the μPD4382322GF.

I/OP1 - I/OP4 is used in the μPD4382362GF

Block Diagram

[μPD4382162, 4382182]

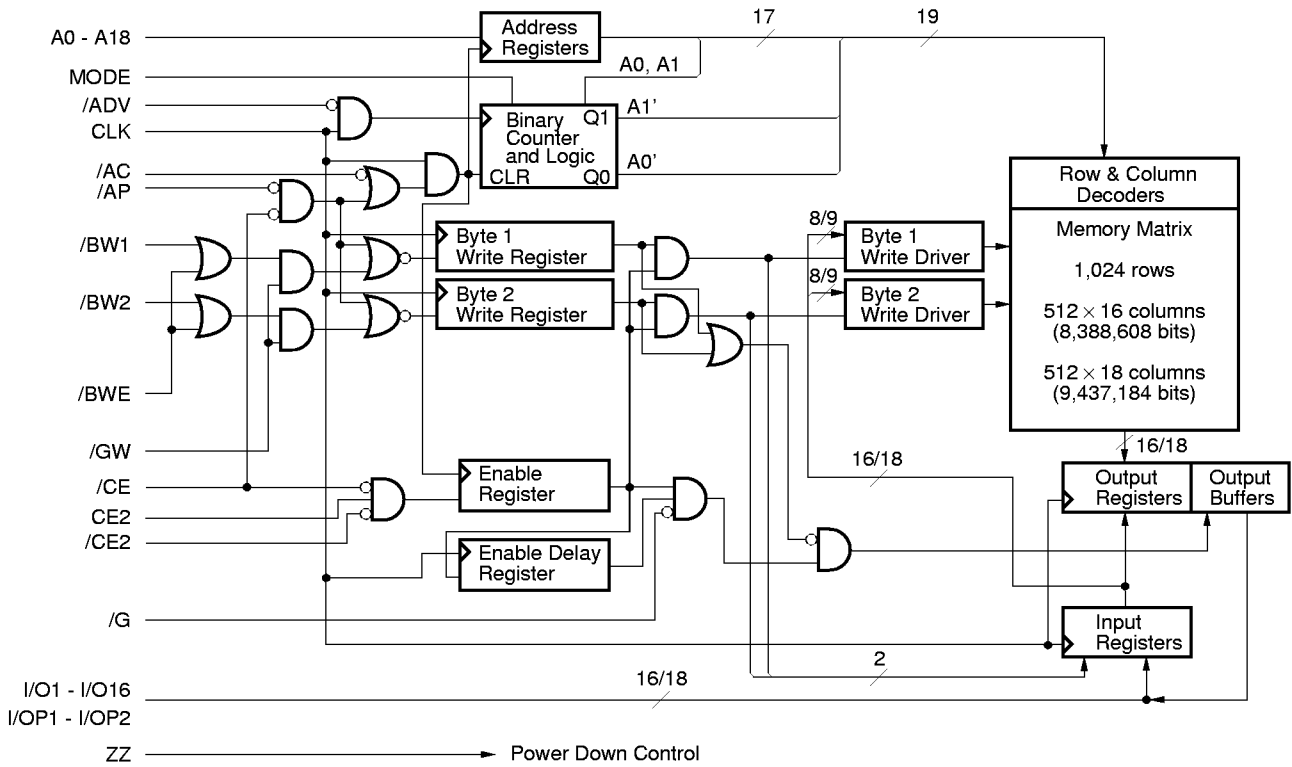

Burst Sequence

[μPD4382162, 4382182]

Interleaved Burst Sequence Table (MODE = Open or VDD)

External Address	A18 - A2, A1, A0
1st Burst Address	A18 - A2, A1, /A0
2nd Burst Address	A18 - A2, /A1, A0
3rd Burst Address	A18 - A2, /A1, /A0

Linear Burst Sequence Table (MODE = VSS)

External Address	A18 - A2, 0, 0	A18 - A2, 0, 1	A18 - A2, 1, 0	A18 - A2, 1, 1
1st Burst Address	A18 - A2, 0, 1	A18 - A2, 1, 0	A18 - A2, 1, 1	A18 - A2, 0, 0
2nd Burst Address	A18 - A2, 1, 0	A18 - A2, 1, 1	A18 - A2, 0, 0	A18 - A2, 0, 1
3rd Burst Address	A18 - A2, 1, 1	A18 - A2, 0, 0	A18 - A2, 0, 1	A18 - A2, 1, 0

[μPD4382322, 4382362]

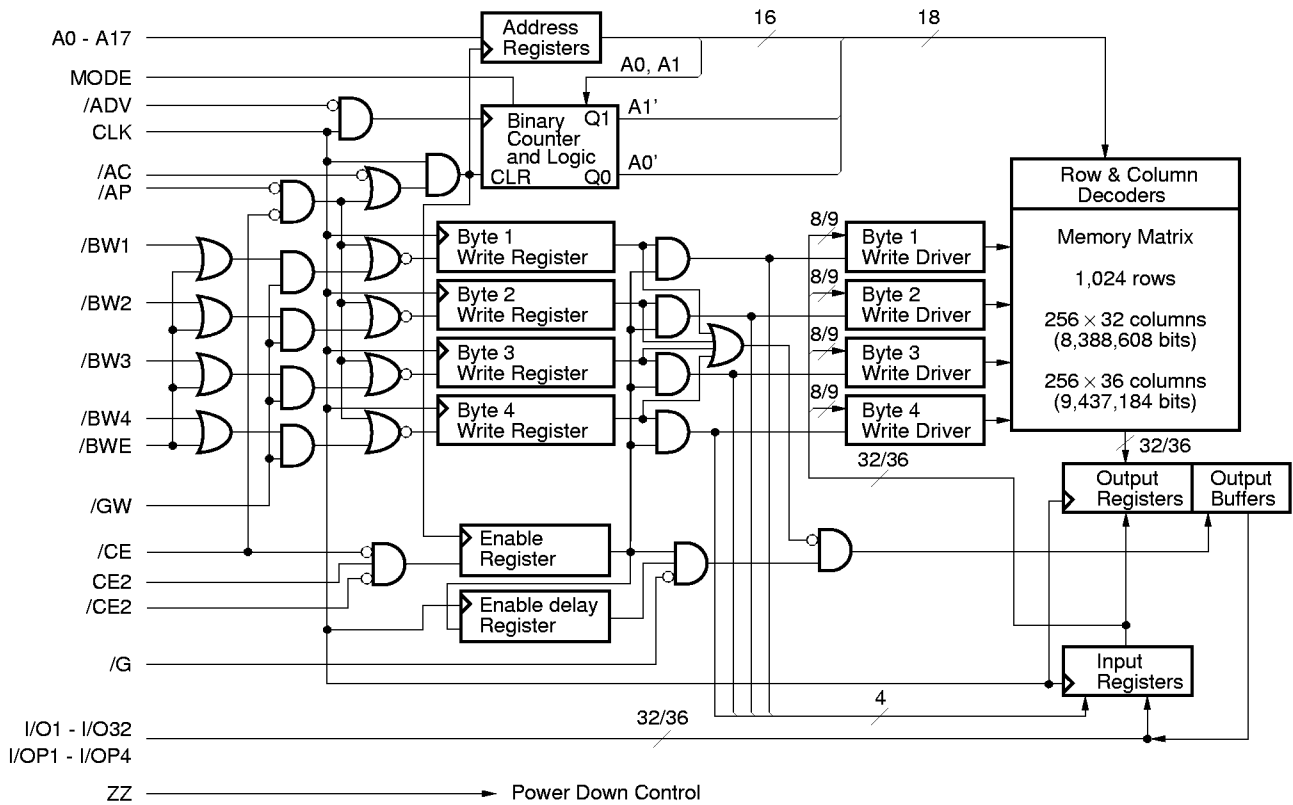

[μPD4382322, 4382362]

Interleaved Burst Sequence Table (MODE = Open or VDD)

External Address	A17 - A2, A1, A0
1st Burst Address	A17 - A2, A1, /A0
2nd Burst Address	A17 - A2, /A1, A0
3rd Burst Address	A17 - A2, /A1, /A0

Linear Burst Sequence Table (MODE = Vss)

External Address	A17 - A2, 0, 0	A17 - A2, 0, 1	A17 - A2, 1, 0	A17 - A2, 1, 1
1st Burst Address	A17 - A2, 0, 1	A17 - A2, 1, 0	A17 - A2, 1, 1	A17 - A2, 0, 0
2nd Burst Address	A17 - A2, 1, 0	A17 - A2, 1, 1	A17 - A2, 0, 0	A17 - A2, 0, 1
3rd Burst Address	A17 - A2, 1, 1	A17 - A2, 0, 0	A17 - A2, 0, 1	A17 - A2, 1, 0

Asynchronous Truth Table

Operation	/G	I/O
Read Cycle	L	Dout
Read Cycle	H	Hi-Z
Write Cycle	X	Hi-Z, Din
Deselected	X	Hi-Z

Remark X means “don’t care.”

Synchronous Truth Table

Operation	/CE	CE2	/CE2	/AP	/AC	/ADV	/WRITE	CLK	Address
Deselected ^{Note}	H	X	X	X	L	X	X	L → H	None
Deselected ^{Note}	L	L	X	L	X	X	X	L → H	None
Deselected ^{Note}	L	X	H	L	X	X	X	L → H	None
Deselected ^{Note}	L	L	X	H	L	X	X	L → H	None
Deselected ^{Note}	L	X	H	H	L	X	X	L → H	None
Read Cycle / Begin Burst	L	H	L	L	X	X	X	L → H	External
Read Cycle / Begin Burst	L	H	L	H	L	X	H	L → H	External
Read Cycle / Continue Burst	X	X	X	H	H	L	H	L → H	Next
Read Cycle / Continue Burst	H	X	X	X	H	L	H	L → H	Next
Read Cycle / Suspend Burst	X	X	X	H	H	H	H	L → H	Current
Read Cycle / Suspend Burst	H	X	X	X	H	H	H	L → H	Current
Write Cycle / Begin Burst	L	H	L	H	L	X	L	L → H	External
Write Cycle / Continue Burst	X	X	X	H	H	L	L	L → H	Next
Write Cycle / Continue Burst	H	X	X	X	H	L	L	L → H	Next
Write Cycle / Suspend Burst	X	X	X	H	H	H	L	L → H	Current
Write Cycle / Suspend Burst	H	X	X	X	H	H	L	L → H	Current

Note Deselect status is held until new “Begin Burst” entry.

Remarks 1. X means “don’t care.”

2. /WRITE = L means any one or more byte write enables (/BW1, /BW2, /BW3 or /BW4) and /BWE are LOW or /GW is LOW.

/WRITE = H means the following two cases.

(1) /BWE and /GW are HIGH.

(2) /BW1, /BW2 and /GW are HIGH, and /BWE is LOW. [μPD4382162, 4382182]

/BW1, /BW2, /BW3, /BW4 and /GW are HIGH, and /BWE is LOW. [μPD4382322, 4382362]

Partial Truth Table for Write Enables

[μPD4382162, 4382182]

Operation	/GW	/BWE	/BW1	/BW2
Read Cycle	H	H	X	X
Read Cycle	H	L	H	H
Write Cycle / Byte 1 Only	H	L	L	H
Write Cycle / All Bytes	H	L	L	L
Write Cycle / All Bytes	L	X	X	X

Remark X means “don’t care.”

[μPD4382322, 4382362]

Operation	/GW	/BWE	/BW1	/BW2	/BW3	/BW4
Read Cycle	H	H	X	X	X	X
Read Cycle	H	L	H	H	H	H
Write Cycle / Byte 1 Only	H	L	L	H	H	H
Write Cycle / All Bytes	H	L	L	L	L	L
Write Cycle / All Bytes	L	X	X	X	X	X

Remark X means “don’t care.”

Pass-Through Truth Table

Previous Cycle				Present Cycle						Next Cycle
Operation	Add	/WRITE	I/O	Operation	Add	/CEs	/WRITE	/G	I/O	Operation
Write Cycle	Ak	L	Dn(Ak)	Read Cycle (Begin Burst)	Am	L	H	L	Q1(Ak)	Read Q1(Am)
				Deselected	-	H	X	X	Hi-Z	No Carry Over from Previous Cycle

Remarks 1. X means “don’t care.”

2. /WRITE = L means any one or more byte write enables (/BW1, /BW2, /BW3 or /BW4) and /BWE are LOW or /GW is LOW.

/WRITE = H means the following two cases.

(1) /BWE and /GW are HIGH.

(2) /BW1, /BW2 and /GW are HIGH, and /BWE is LOW. [μPD4382162, 4382182]

/BW1, /BW2, /BW3, /BW4 and /GW are HIGH, and /BWE is LOW. [μPD4382322, 4382362]

/CEs = L means /CE is LOW, /CE2 is LOW and CE2 is HIGH.

/CEs = H means /CE is HIGH or /CE2 is HIGH or CE2 is LOW.

ZZ (Sleep) Truth Table

ZZ	Chip Status
≤ 0.2V	Active
Open	Active
≥ V _{DD} - 0.2V	Sleep

Electrical Specifications

Absolute Maximum Ratings

Parameter	Symbol	Conditions	MIN.	TYP.	MAX.	Unit	Note
Supply voltage	V _{DD}		-0.5		+4.0	V	
Output supply voltage	V _{DDQ}		-0.5		V _{DD}	V	
Input voltage	V _{IN}		-0.5		V _{DD} + 0.5	V	1, 2
Input / Output voltage	V _{I/O}		-0.5		V _{DDQ} + 0.5	V	1, 2
Power dissipation	P _d		-		1.6	W	
Operating ambient temperature	T _A		0		70	°C	
Storage temperature	T _{stg}		-55		+125	°C	

- Notes** 1. -2.0 V (MIN.) (Pulse width : 2 ns)
 2. V_{DDQ} + 2.3 V (MAX.) (Pulse width : 2 ns)

Caution Exposing the device to stress above those listed in Absolute Maximum Ratings could cause permanent damage. The device is not meant to be operated under conditions outside the limits described in the operational section of this specification. Exposure to Absolute Maximum Rating conditions for extended periods may affect device reliability.

Recommended DC Operating Conditions (T_A = 0 to 70 °C)

Parameter	Symbol	Conditions	MIN.	TYP.	MAX.	Unit
Supply voltage	V _{DD}		3.135	3.3	3.465	V
2.5 V LVTTTL Interface						
Output supply voltage	V _{DDQ}		2.375	2.5	2.9	V
High level input voltage	V _{IH}		1.7		V _{DDQ} + 0.3	V
Low level input voltage	V _{IL}		-0.3 ^{Note}		+0.7	V
3.3 V LVTTTL Interface						
Output supply voltage	V _{DDQ}		3.135	3.3	3.465	V
High level input voltage	V _{IH}		2.0		V _{DDQ} + 0.3	V
Low level input voltage	V _{IL}		-0.3 ^{Note}		+0.8	V

Note -0.8 V (MIN.) (Pulse Width : 2 ns)

Capacitance (T_A = 25 °C, f = 1MHz)

Parameter	Symbol	Test conditions	MIN.	TYP.	MAX.	Unit
Input capacitance	C _{IN}	V _{IN} = 0 V			4	pF
Input / Output capacitance	C _{I/O}	V _{I/O} = 0 V			7	pF
Clock Input capacitance	C _{clk}	V _{clk} = 0 V			4	pF

Remark These parameters are periodically sampled and not 100% tested.

DC Characteristics (TA = 0 to 70°C, VDD = 3.3 ± 0.165 V)

Parameter	Symbol	Test condition	MIN.	TYP.	MAX.	Unit	Note
Input leakage current	ILI	VIN(except ZZ, MODE) = 0 V to VDD	-2		+2	μA	
I/O leakage current	ILO	V/I/O = 0 V to VDDQ, Output disabled	-2		+2	μA	
Operating supply current	Icc	Device selected, Cycle = MAX. VIN ≤ VIL or VIN ≥ VIH, I/I/O = 0 mA	-A67		440	mA	
			-A67B				
			-A75		400		
			-A75B				
	Icc1	Suspend cycle, Cycle = MAX. /AC, /AP, /ADV, /GW, /BWEs ≥ VIH, VIN ≤ VIL or VIN ≥ VIH, I/I/O = 0 mA	-A67		170		
			-A67B				
			-A75		150		
			-A75B				
Standby supply current	ISB	Device deselected, Cycle = 0 MHz VIN ≤ VIL or VIN ≥ VIH, All inputs static			30	mA	
					10		
	ISB1	Device deselected, Cycle = 0 MHz VIN ≤ 0.2V or VIN ≥ VDD - 0.2V, V/I/O ≤ 0.2 V, All inputs static	-A67		180		
			-A67B				
			-A75		170		
			-A75B				
ISB2	Device deselected, Cycle = MAX. VIN ≤ VIL or VIN ≥ VIH						
Power down supply current	ISBZZ	ZZ ≥ VDD - 0.2V, V/I/O ≤ VDDQ + 0.2V			10	mA	
2.5 V LVTTTL Interface							
High level output voltage	VOH	I _{OH} = -2.0 mA	2.1			V	
Low level output voltage	VOL	I _{OL} = +2.0 mA			0.3	V	
3.3 V LVTTTL Interface							
High level output voltage	VOH	I _{OH} = -4.0 mA	2.4			V	
Low level output voltage	VOL	I _{OL} = +8.0 mA			0.4	V	

AC Characteristics (TA = 0 to 70 °C, VDD = 3.3 ± 0.165 V)

AC Test Conditions

2.5 V LVTTTL Interface

Input waveform (Rise / Fall time \leq 2.4 ns)

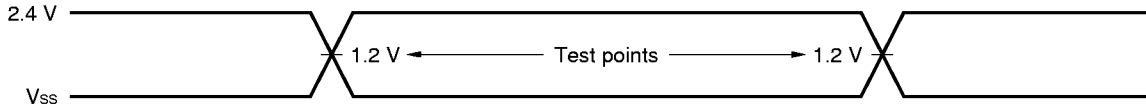

Output waveform

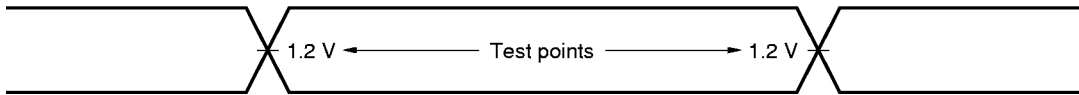

3.3 V LVTTTL Interface

Input waveform (Rise / Fall time \leq 3.0 ns)

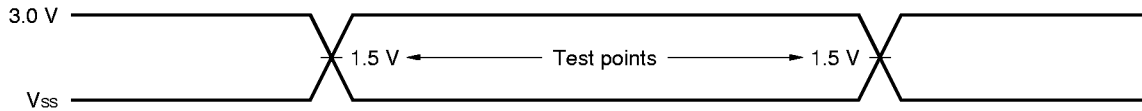

Output waveform

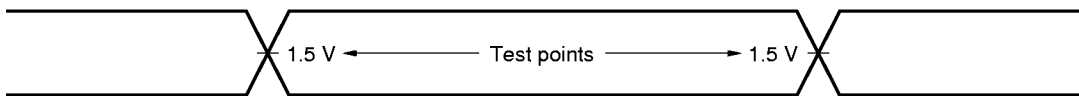

Output load condition

- CL : 30 pF
- 5 pF (TDC1, TDC2, TOLZ, TOHZ, TCZ)

Figure1 External load at test

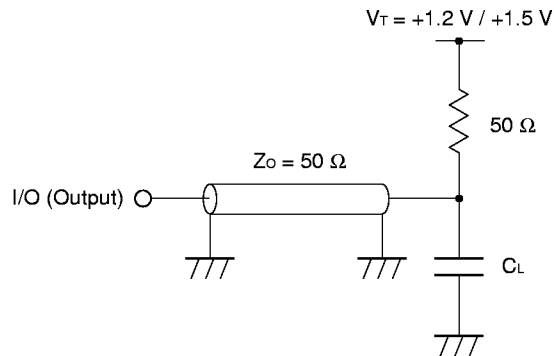

Remark CL includes capacitances of the probe and jig, and stray capacitances.

Read and Write Cycle (2.5 V LVTTTL Interface)

Parameter	Symbol		-A67B (150 MHz)		-A75B (133 MHz)		Unit	Note
	Standard	Alias	MIN.	MAX.	MIN.	MAX.		
Cycle time	TKHKH	TCYC	6.66	–	7.5	–	ns	
Clock access time	TKHQV	TCD	–	3.8	–	4	ns	
Output enable access time	TGLQV	TOE	–	3.8	–	4	ns	
Clock high to output active	TKHQX1	TDC1	0	–	0	–	ns	
Clock high to output change	TKHQX2	TDC2	1.5	–	1.5	–	ns	
Output enable to output active	TGLQX	TOLZ	0	–	0	–	ns	
Output disable to output high-Z	TGHQZ	TOHZ	0	3.5	0	3.5	ns	
Clock high to output high-Z	TKHQZ	TCZ	1.5	3.8	1.5	4	ns	
Clock high pulse width	TKHKL	TCH	2	–	2	–	ns	
Clock low pulse width	TKLKH	TCL	2	–	2	–	ns	
Setup times	Address	TAVKH	TAS	2	–	2	–	ns
	Address status	TADSVKH	TSS					
	Data in	TDVKH	TDS					
	Write enable	TWVKH	TWS					
	Address advance	TADVVKH	–					
	Chip enable	TEVKH	–					
Hold times	Address	TKHAX	TAH	0.5	–	0.5	–	ns
	Address status	TKHADSX	TSH					
	Data in	TKHDX	TDH					
	Write enable	TKHWX	TWH					
	Address advance	TKHADVX	–					
	Chip enable	TKHEX	–					
Power down entry setup	TZZES	TZZES	5	–	5	–	ns	1
Power down entry hold	TZZEH	TZZEH	1	–	1	–	ns	1
Power down recovery setup	TZZRS	TZZRS	6	–	6	–	ns	1
Power down recovery hold	TZZRH	TZZRH	0	–	0	–	ns	1

Note 1. Although ZZ signal input is asynchronous, the signal must meet specified setup and hold times in order to be recognized.

Read and Write Cycle (3.3 V LVTTL Interface)

Parameter	Symbol		-A67 (150 MHz)		-A75 (133 MHz)		Unit	Note
	Standard	Alias	MIN.	MAX.	MIN.	MAX.		
Cycle time	TKHKKH	TCYC	6.66	–	7.5	–	ns	
Clock access time	TKHQV	TCD	–	3.8	–	4	ns	
Output enable access time	TGLQV	TOE	–	3.8	–	4	ns	
Clock high to output active	TKHQX1	TDC1	0	–	0	–	ns	
Clock high to output change	TKHQX2	TDC2	1.5	–	1.5	–	ns	
Output enable to output active	TGLQX	TOLZ	0	–	0	–	ns	
Output disable to output high-Z	TGHQZ	TOHZ	0	3.5	0	3.5	ns	
Clock high to output high-Z	TKHQZ	TCZ	1.5	3.8	1.5	4	ns	
Clock high pulse width	TKHKL	TCH	2	–	2	–	ns	
Clock low pulse width	TKLKH	TCL	2	–	2	–	ns	
Setup times	Address	TAVKH	TAS	2	–	2	–	ns
	Address status	TADSVKH	TSS					
	Data in	TDVKH	TDS					
	Write enable	TWVKH	TWS					
	Address advance	TADVVKH	–					
	Chip enable	TEVKH	–					
Hold times	Address	TKHAX	TAH	0.5	–	0.5	–	ns
	Address status	TKHADSX	TSH					
	Data in	TKHDX	TDH					
	Write enable	TKHWX	TWH					
	Address advance	TKHADVX	–					
	Chip enable	TKHEX	–					
Power down entry setup	TZZES	TZZES	5	–	5	–	ns	1
Power down entry hold	TZZEH	TZZEH	1	–	1	–	ns	1
Power down recovery setup	TZZRS	TZZRS	6	–	6	–	ns	1
Power down recovery hold	TZZRH	TZZRH	0	–	0	–	ns	1

Note 1. Although ZZ signal input is asynchronous, the signal must meet specified setup and hold times in order to be recognized.

READ CYCLE

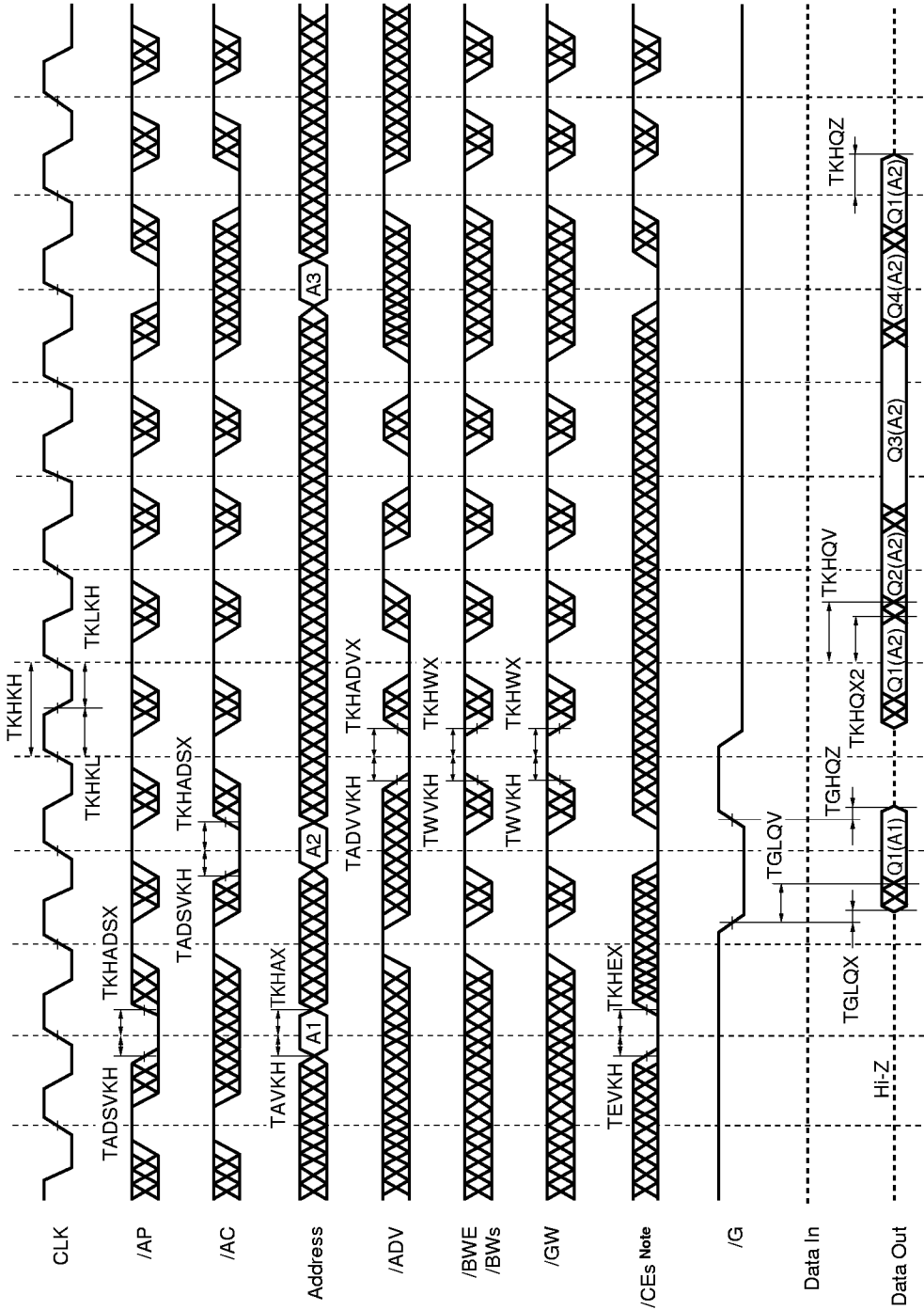

Note /CEs refers to /CE, CE2 and /CE2. When /CEs is LOW, /CE and /CE2 are LOW and CE2 is HIGH.
When /CEs is HIGH, /CE and /CE2 are HIGH and CE2 is LOW.

Remark Qn(A2) refers to output from address A2. Q1-Q4 refer to outputs according to burst sequence.

WRITE CYCLE

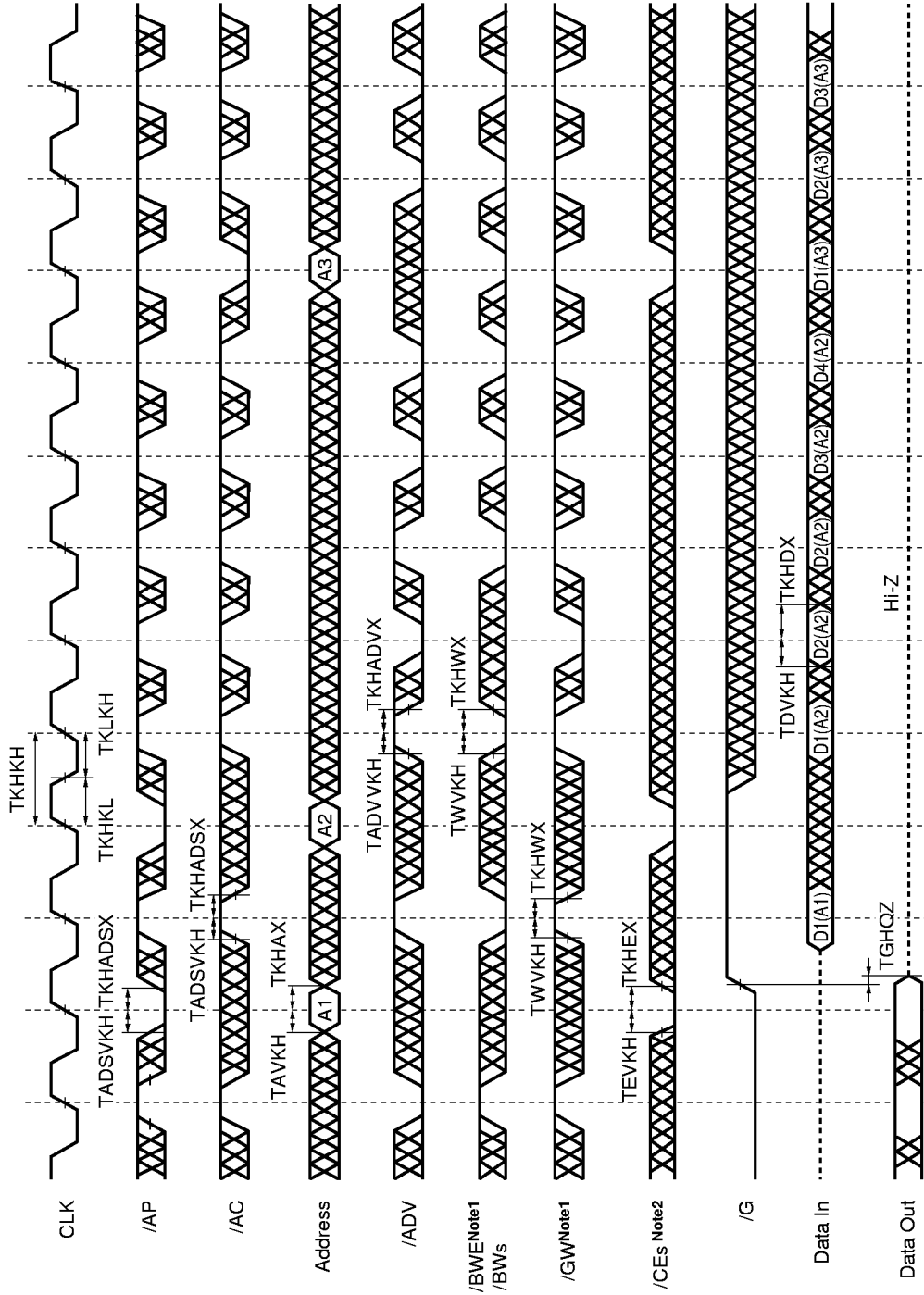

- Notes**
1. All bytes WRITE can be initiated by /GW LOW or /GW HIGH and /BWE, /BW1-/BW4 LOW.
 2. /CEs refers to /CE, CE2 and /CE2. When /CEs is LOW, /CE and /CE2 are LOW and CE2 is HIGH. When /CEs is HIGH, /CE and /CE2 are HIGH and CE2 is LOW.

READ / WRITE CYCLE

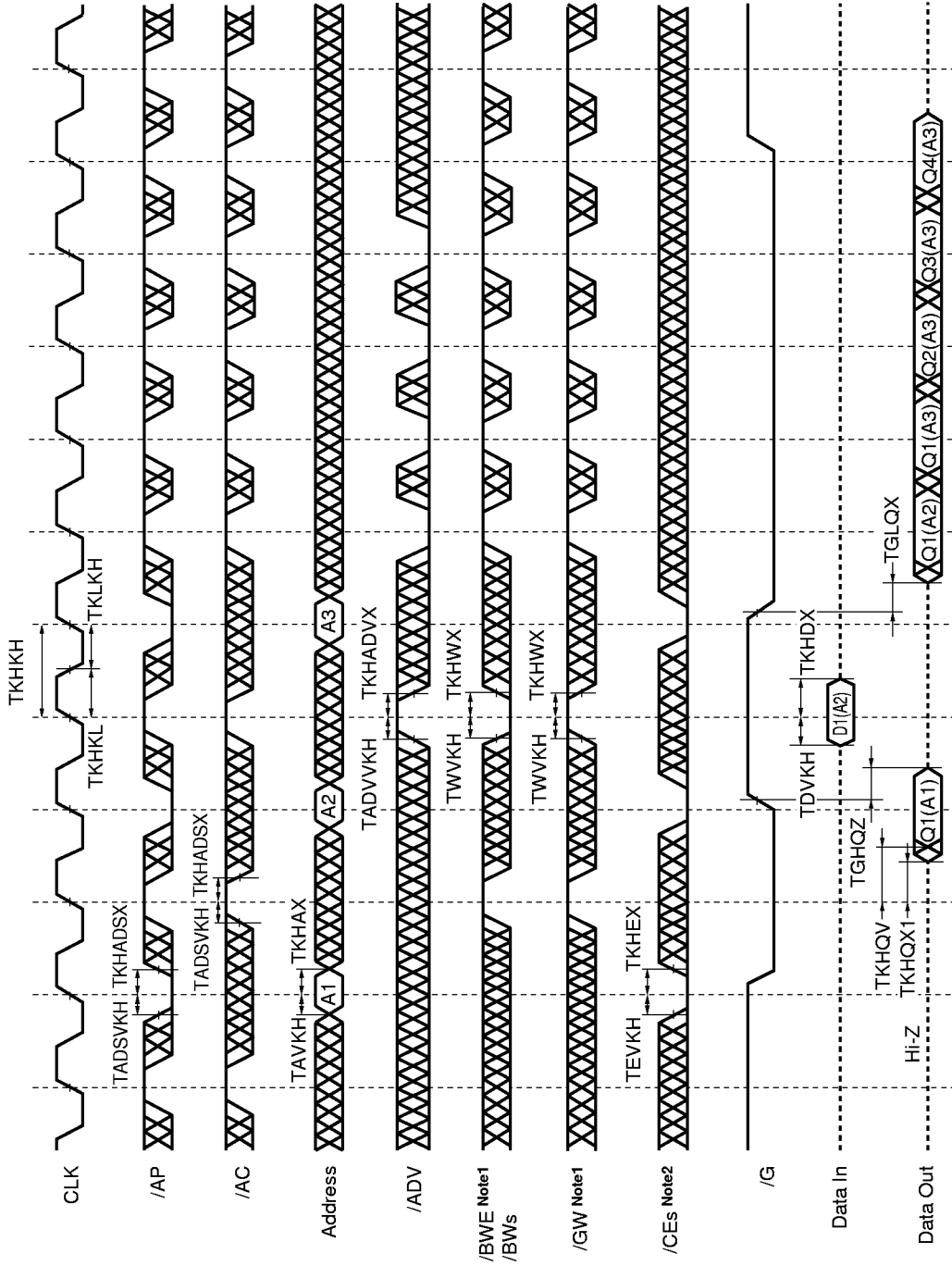

- Notes**
1. All bytes WRITE can be initiated by /GW LOW or /GW HIGH and /BWE, /BW1-/BW4 LOW.
 2. /CEs refers to /CE1, CE2 and /CE2. When /CEs is LOW, /CE and /CE2 are LOW and CE2 is HIGH. When /CEs is HIGH, /CE and /CE2 are HIGH and CE2 is LOW.

POWER DOWN (ZZ) CYCLE

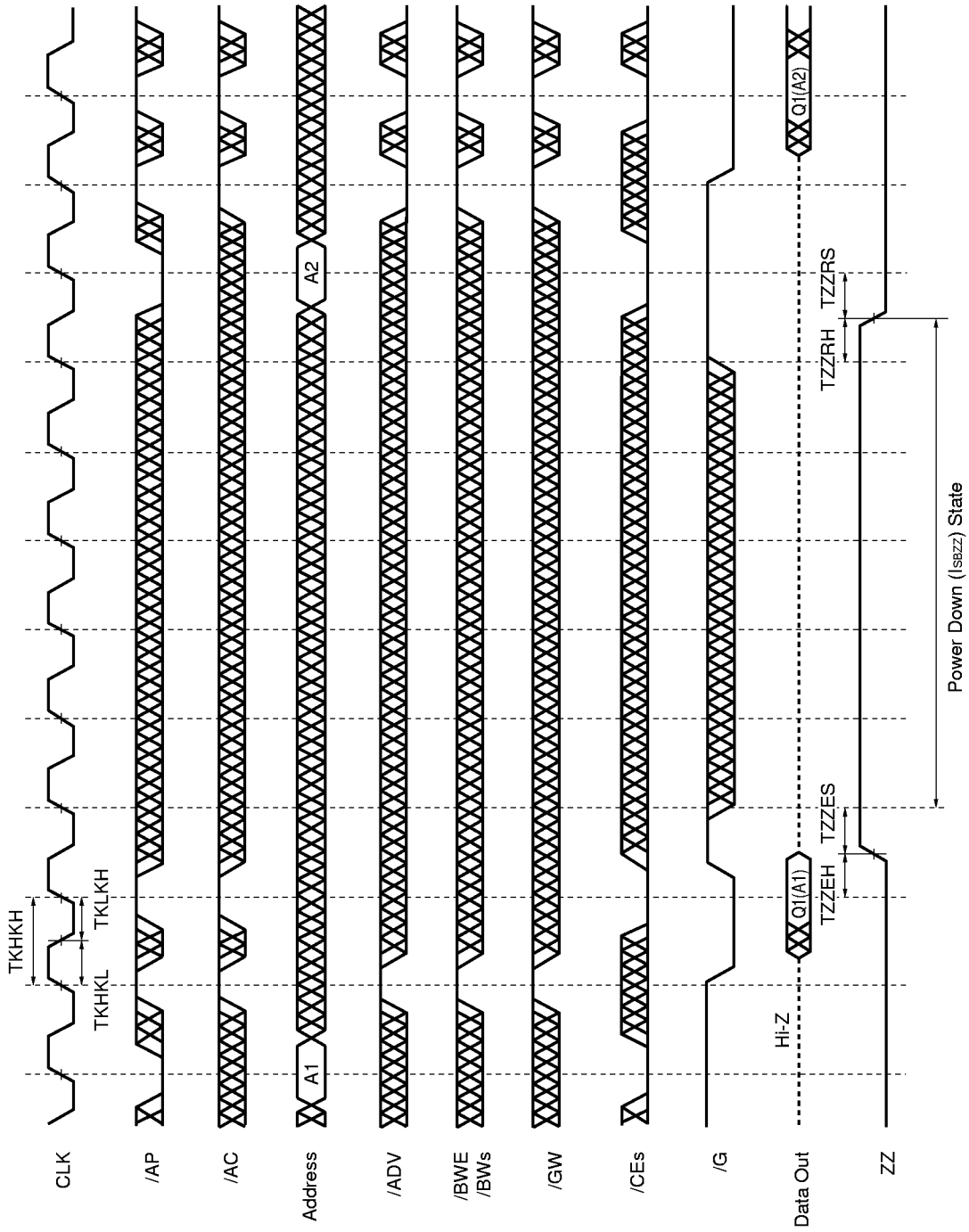

STOP CLOCK CYCLE

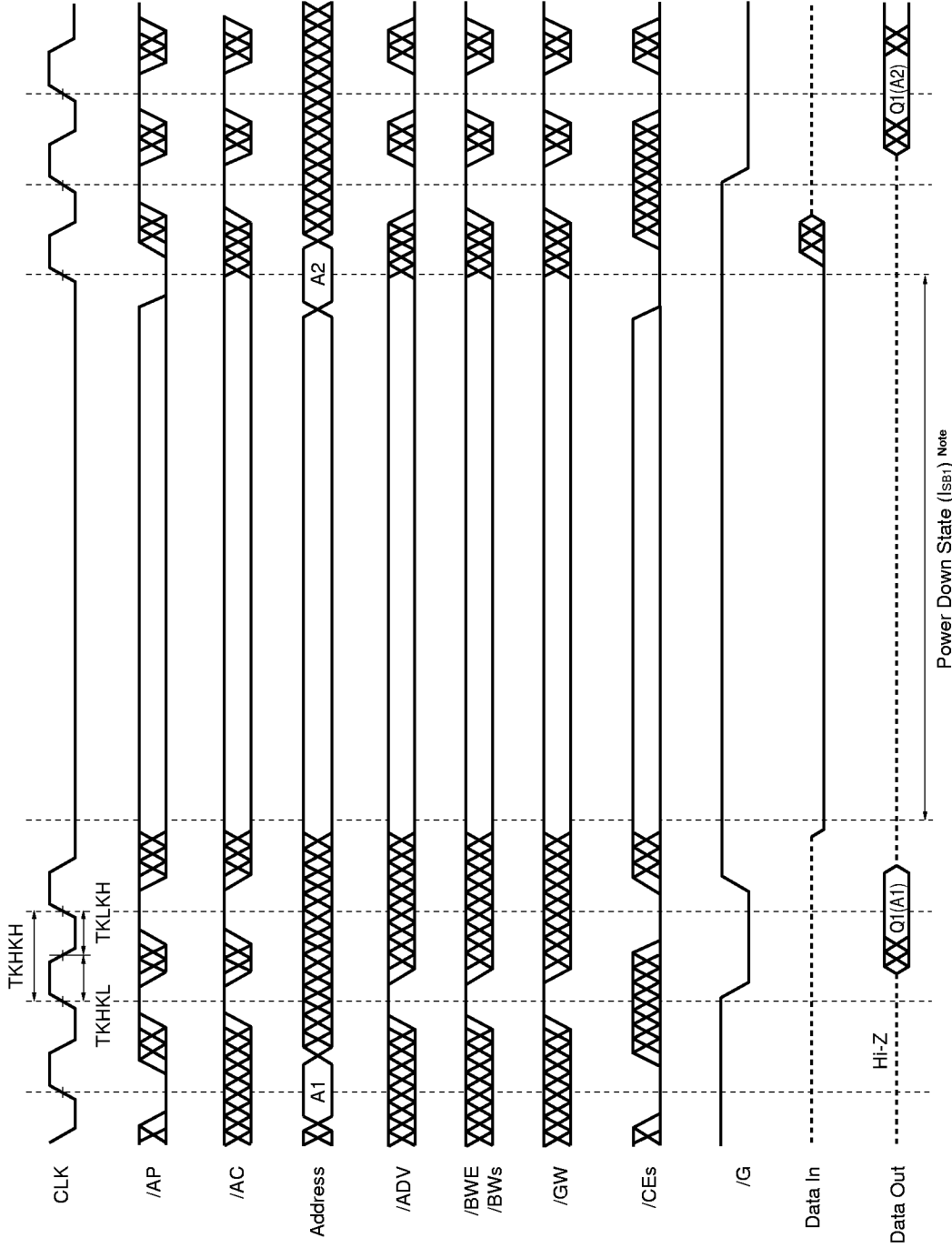

Note $V_{IN} \leq 0.2 V$ or $V_{IN} \geq V_{DD} - 0.2 V$, $V_{IO} \leq 0.2 V$

Package Drawing

100 PIN PLASTIC LQFP (14×20)

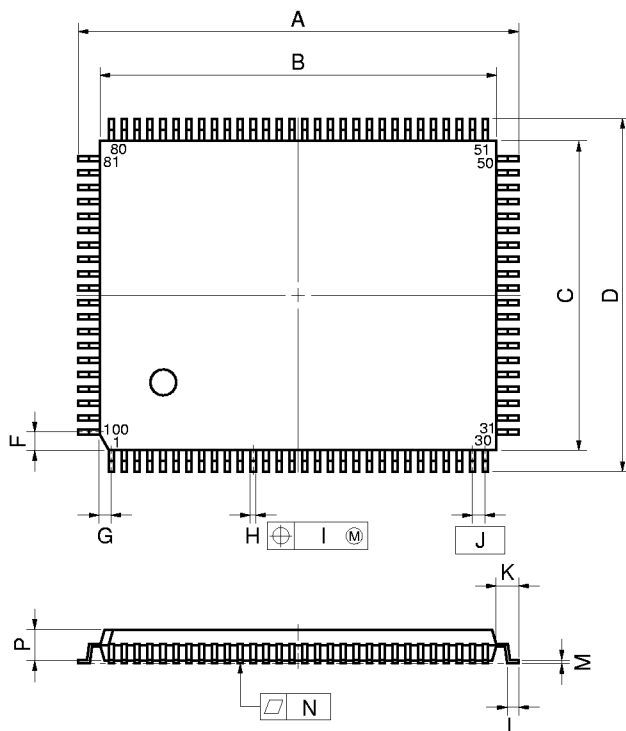

detail of lead end

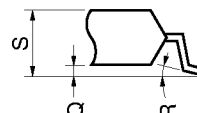

NOTE

Each lead centerline is located within 0.13 mm (0.005 inch) of its true position (T.P.) at maximum material condition.

ITEM	MILLIMETERS	INCHES
A	22.0±0.2	0.866±0.008
B	20.0±0.2	0.787 ^{+0.009} _{-0.008}
C	14.0±0.2	0.551 ^{+0.009} _{-0.008}
D	16.0±0.2	0.630±0.008
F	0.825	0.032
G	0.575	0.023
H	0.32 ^{+0.08} _{-0.07}	0.013±0.003
I	0.13	0.005
J	0.65 (T.P.)	0.026 (T.P.)
K	1.0±0.2	0.039 ^{+0.009} _{-0.008}
L	0.5±0.2	0.020 ^{+0.008} _{-0.009}
M	0.17 ^{+0.06} _{-0.05}	0.007±0.002
N	0.10	0.004
P	1.4	0.055
Q	0.125±0.075	0.005±0.003
R	3° ^{+7°} _{-3°}	3° ^{+7°} _{-3°}
S	1.7 MAX.	0.067 MAX.

S100GF-65-8ET

Recommended Soldering Condition

Please consult with our sales offices for soldering conditions of the μ PD4382162, 4382182, 4382322 and 4382362.

Type of Surface Mount Devices

μ PD4382162GF : 100-pin plastic LQFP (14 x 20 mm)

μ PD4382182GF : 100-pin plastic LQFP (14 x 20 mm)

μ PD4382322GF : 100-pin plastic LQFP (14 x 20 mm)

μ PD4382362GF : 100-pin plastic LQFP (14 x 20 mm)

NOTES FOR CMOS DEVICES

① PRECAUTION AGAINST ESD FOR SEMICONDUCTORS

Note:

Strong electric field, when exposed to a MOS device, can cause destruction of the gate oxide and ultimately degrade the device operation. Steps must be taken to stop generation of static electricity as much as possible, and quickly dissipate it once, when it has occurred. Environmental control must be adequate. When it is dry, humidifier should be used. It is recommended to avoid using insulators that easily build static electricity. Semiconductor devices must be stored and transported in an anti-static container, static shielding bag or conductive material. All test and measurement tools including work bench and floor should be grounded. The operator should be grounded using wrist strap. Semiconductor devices must not be touched with bare hands. Similar precautions need to be taken for PW boards with semiconductor devices on it.

② HANDLING OF UNUSED INPUT PINS FOR CMOS

Note:

No connection for CMOS device inputs can be cause of malfunction. If no connection is provided to the input pins, it is possible that an internal input level may be generated due to noise, etc., hence causing malfunction. CMOS devices behave differently than Bipolar or NMOS devices. Input levels of CMOS devices must be fixed high or low by using a pull-up or pull-down circuitry. Each unused pin should be connected to V_{DD} or GND with a resistor, if it is considered to have a possibility of being an output pin. All handling related to the unused pins must be judged device by device and related specifications governing the devices.

③ STATUS BEFORE INITIALIZATION OF MOS DEVICES

Note:

Power-on does not necessarily define initial status of MOS device. Production process of MOS does not define the initial operation status of the device. Immediately after the power source is turned ON, the devices with reset function have not yet been initialized. Hence, power-on does not guarantee out-pin levels, I/O settings or contents of registers. Device is not initialized until the reset signal is received. Reset operation must be executed immediately after power-on for devices having reset function.