

Bussed Resistor Network

Features

- Stable thin film resistor network
- High speed termination network
- 7, 13, 15, 19, or 23 terminating lines/package
- Saves board space & reduces assembly cost
- Offered in SOIC and QSOP packages

www.DataSheet4U.com

Applications¹

- Parallel termination
- Pull up / Pull down
- Digital pulse squaring
- Coding and decoding
- Telemetry

1. Refer to AP-201 Termination Application Note for further information on applications of this device.

Product Description

California Micro Devices' PRN101/111 Bused Resistor Networks offer high integration and performance in a miniature QSOP or SOIC package, which saves critical board area and provides manufacturing cost and reliability efficiencies. This part is well-suited as a general purpose replacement for all popular discrete resistor chips and larger size thick film technology packages.

Why thin film resistor networks? A terminating resistor is used to reduce or eliminate unwanted reflections on a transmission line or in some cases provide DC pull-up/pull-down. It can perform this function only when its resistance value is closely matched to the characteristic impedance of the transmission line. The resistors used for terminating transmission lines must be noiseless, stable, and functional at high frequencies. Unlike thin film-based resistor networks, conventional thick film resistors used for this purpose are not stable over temperature and time, and may have functional limitations when used in high frequency applications.

Electrical Schematic Configurations

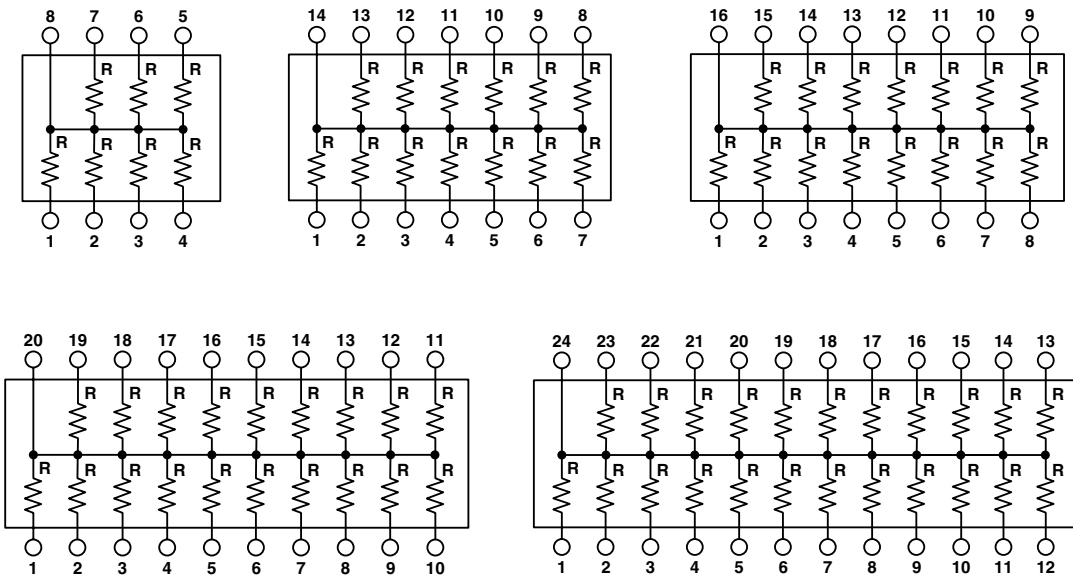

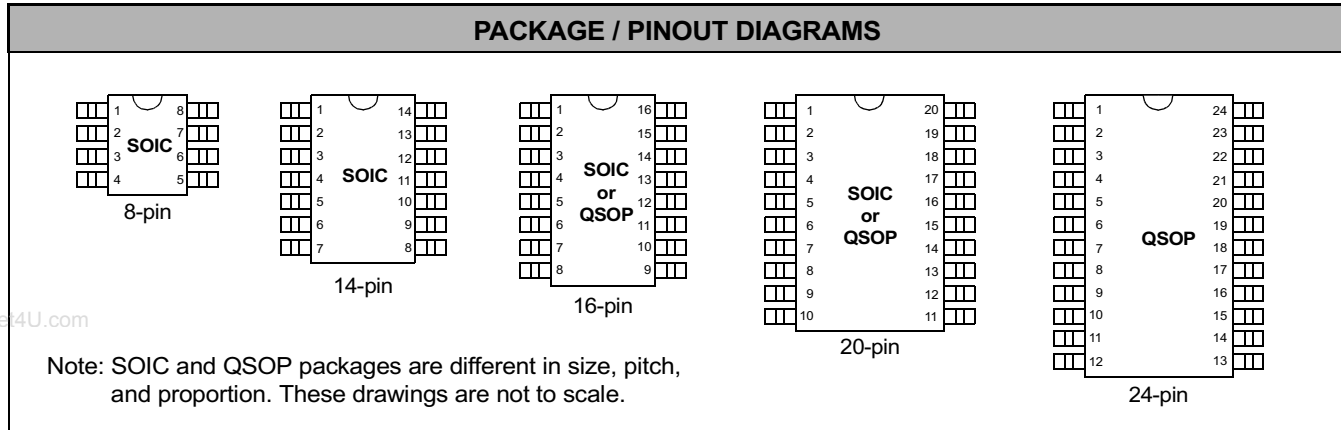

Ordering Information

PRN101/111 part ordering options are presented in the Part Ordering Information table below. For standard and non-standard resistor values and part numbers by parameter values, see the Part Values table and Part Number Key, respectively.

STANDARD AND NON-STANDARD PART ORDERING INFORMATION								
Package			Parameters				Ordering Part Number ²	Part Marking
Style	Pins	Package Width	Resistance Code ¹	Tolerance	TCR	Ratio Tolerance		
Standard Parts:								
SOIC	16	Narrow	xxxx (standard values)	±5%	±250ppm/°C	±0.5%	PRN10116NxxxxJP	PRN10116NxxxxJP
QSOP	24	--	xxxx (standard values)	±5%	±250ppm/°C	±0.5%	PRN11124xxxxJP	PRN11124xxxxJP
Non-Standard Parts ³ :								
SOIC	8 14 16 20	Narrow or Wide	xxxx (within non-std value ranges)	±1% ±2% ±5%	±250ppm/°C ±100ppm/°C ±50ppm/°C ±25ppm/°C	±0.05% ±0.1% ±0.2% ±0.5% ±1%	See Part Number Key in Figure 1 .	See Part Number Key in Figure 1 .
QSOP	16 20 24	--	xxxx (within non-std value ranges)	±1% ±2% ±5%	±250ppm/°C ±100ppm/°C ±50ppm/°C ±25ppm/°C	±0.05% ±0.1% ±0.2% ±0.5% ±1%	See Part Number Key in Figure 1 .	See Part Number Key in Figure 1 .

Note 1: xxxx resistance code format follows guideline defined in [Figure 1](#) for standard or non-standard parts.

Note 2: Parts are shipped in Tape & Reel form unless otherwise specified.

Note 3: A Non-Recurring Engineering (NRE) charge and a minimum order/lot size may apply for all fully customized requirements.



Ordering Information (continued)

PRN101/111 standard and non-standard resistor values are presented in the Part Values table below.

PART VALUES			
STANDARD RESISTOR VALUES		NON-STANDARD RESISTOR VALUE RANGE	
Code	R (Ω) Isolated	Code	Resistance Range (Ω)
51R0	51	xxxx (see Figure 1)	10Ω to 47kΩ
56R0	56		
3300	330		
3900	390		
6800	680		
1001	1K		
1101	1.1K		
2001	2K		
2201	2.2K		
2701	2.7K		
4701	4.7K		
6801	6.8K		
1002	10K		
2002	20K		
4702	47K		

Ordering Information (continued)

A guide for constructing part numbers from desired device parameters is presented in the Part Number Key below.

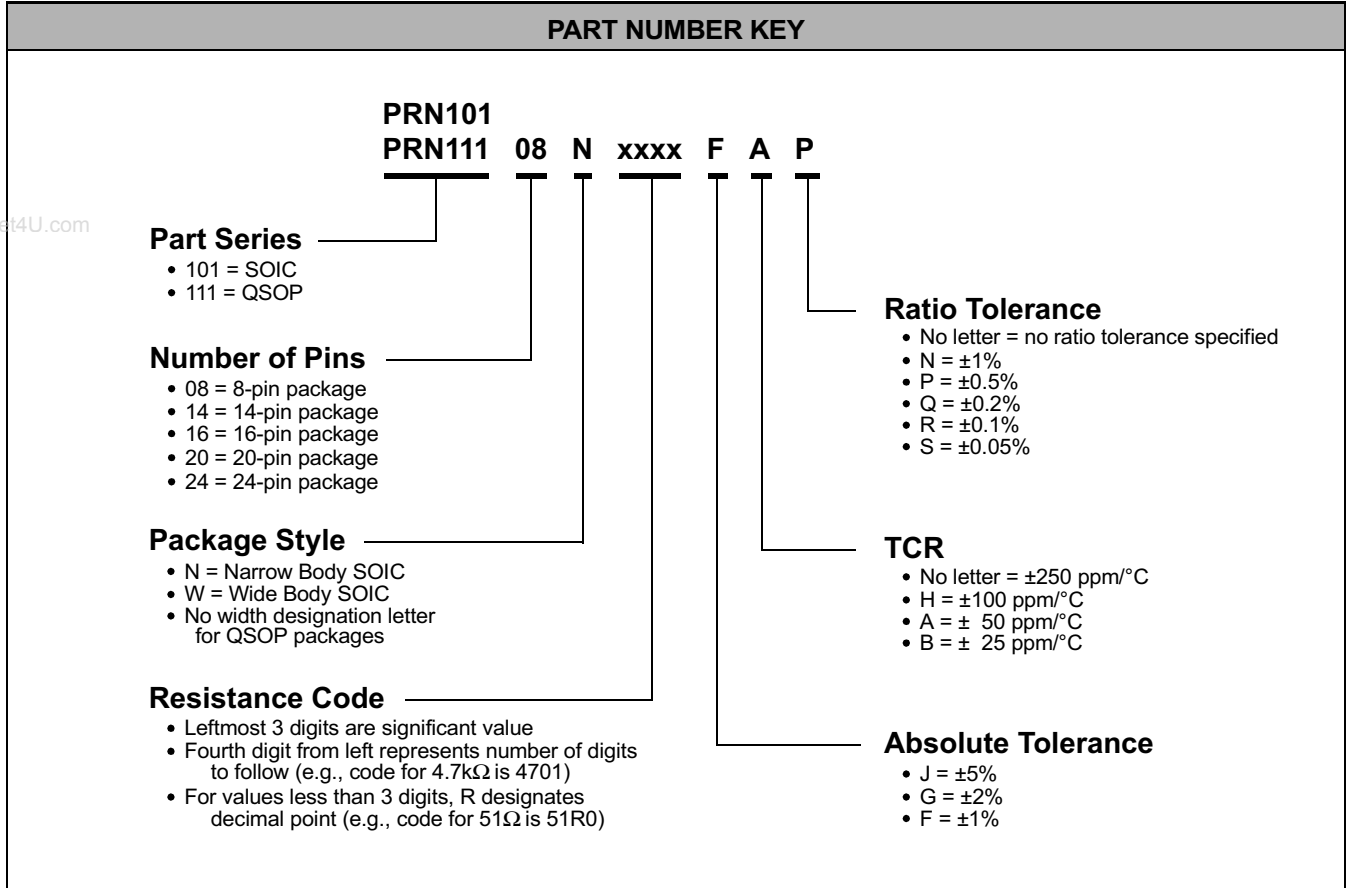

Figure 1. Part Number Key

Specifications

ABSOLUTE MAXIMUM RATINGS		
PARAMETER	RATING	UNITS
Operating Temperature Range	-55 to +125	°C
Storage Temperature Range	-65 to +150	°C
Max DC Power to each Resistor: for R < 1kΩ	100	mW
for R ≥ 1kΩ	25	mW

Specifications (continued)
STANDARD OPERATING CONDITIONS

PARAMETER	RATING	UNITS
Ambient Operating Temperature Range	-55 to +125	°C

STANDARD ELECTRICAL OPERATING CHARACTERISTICS

SYMBOL	PARAMETER	CONDITIONS	MIN	TYP	MAX	UNITS
TOL _R	Absolute Resistor Tolerance				±5	%
TOL _{RR}	Ratio Resistance Tolerance			±0.5		%
TCR	Temperature Coefficient of Resistance				±250	ppm/°C
TTCR	Tracking Temperature Coefficient of Resistance				±5	ppm/°C
R _{INS}	Insulation Resistance		10,000			MΩ

NON-STANDARD ELECTRICAL OPERATING CHARACTERISTICS

SYMBOL	PARAMETER	AVAILABLE VALUES	UNITS
TOL _R	Absolute Resistor Tolerance	±2, ±1	%
TOL _{RR}	Ratio Resistance Tolerance	±0.05, ±0.1, ±0.2, ±0.5, ±1.0,	%
TCR	Ratio Resistance Tolerance	±250, ±100, ±50, ±25	ppm/°C

Performance Information

Power dissipation figures for the various package options at 70°C are presented below.

POWER DISSIPATION

PACKAGE	PIN COUNT	POWER RATING ¹ (W)
SOIC	8 Pin	0.4
	14 Pin	0.8
	16 Pin Narrow	0.8
	16 Pin Wide	1.0
	20 Pin	1.2
QSOP	16 Pin	0.75
	20 Pin	1.0
	24 Pin	1.0

Note 1: Power ratings are specified at 70°C.



Mechanical Details

PRN101/111 devices are packaged in either SOIC packages (8, 14, 16-narrow, 16-wide, or 20 pins) or QSOP packages (16, 20, or 24 pins).

SOIC-8 Mechanical Specifications:

Dimensions for PRN101/111 devices packaged in 8-pin SOIC packages are presented below.

For complete information on the SOIC-8 package, see the California Micro Devices SOIC Package Information document.

PACKAGE DIMENSIONS				
Package	SOIC			
Pins	8			
Dimensions	Millimeters		Inches	
	Min	Max	Min	Max
A	1.35	1.75	0.053	0.069
A ₁	0.10	0.25	0.004	0.010
B	0.33	0.51	0.013	0.020
C	0.19	0.25	0.007	0.010
D	4.80	5.00	0.189	0.197
E	3.80	4.19	0.150	0.165
e	1.27 BSC		0.050 BSC	
H	5.80	6.20	0.228	0.244
L	0.40	1.27	0.016	0.050
# per tube	100 pieces*			
# per tape and reel	2500 pieces			
Controlling dimension: inches				

* This is an approximate amount which may vary.

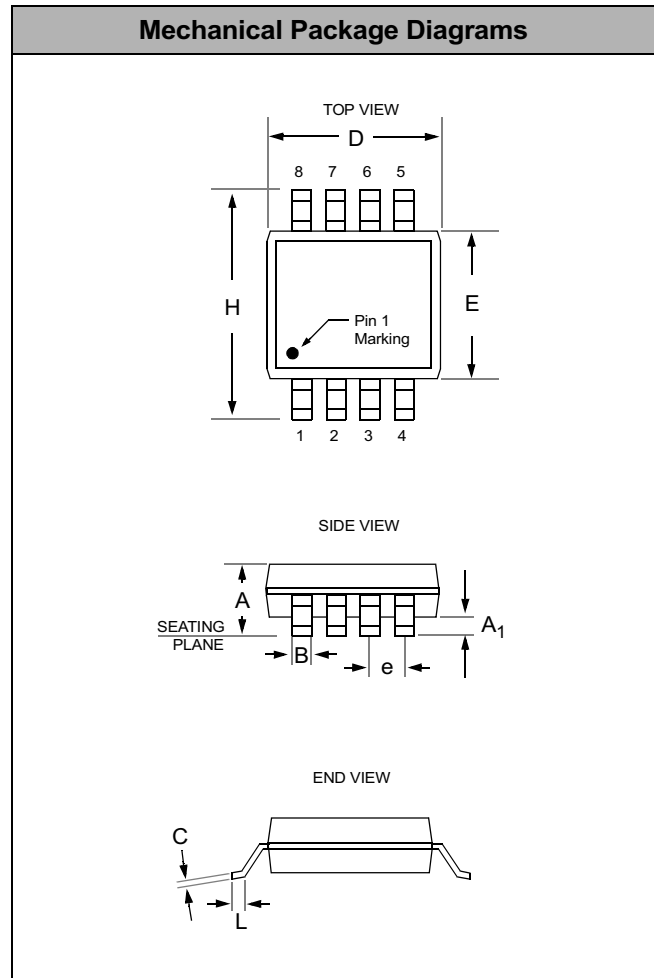

Package Dimensions for SOIC-8

Mechanical Details (continued)

SOIC-14 Mechanical Specifications:

Dimensions for PRN101/111 devices packaged in 14-

pin SOIC packages are presented below.



For complete information on the SOIC-14 package, see the California Micro Devices SOIC Package Information document.

PACKAGE DIMENSIONS				
Package	SOIC			
Pins	14			
Dimensions	Millimeters		Inches	
	Min	Max	Min	Max
A	1.35	1.75	0.053	0.069
A ₁	0.10	0.25	0.004	0.010
B	0.33	0.51	0.013	0.020
C	0.19	0.25	0.007	0.010
D	8.55	8.75	0.337	0.344
E	3.80	4.19	0.150	0.165
e	1.27 BSC		0.050 BSC	
H	5.80	6.20	0.228	0.244
L	0.40	1.27	0.016	0.050
# per tube	55 pieces*			
# per tape and reel	2500 pieces			
Controlling dimension: inches				

* This is an approximate amount which may vary.

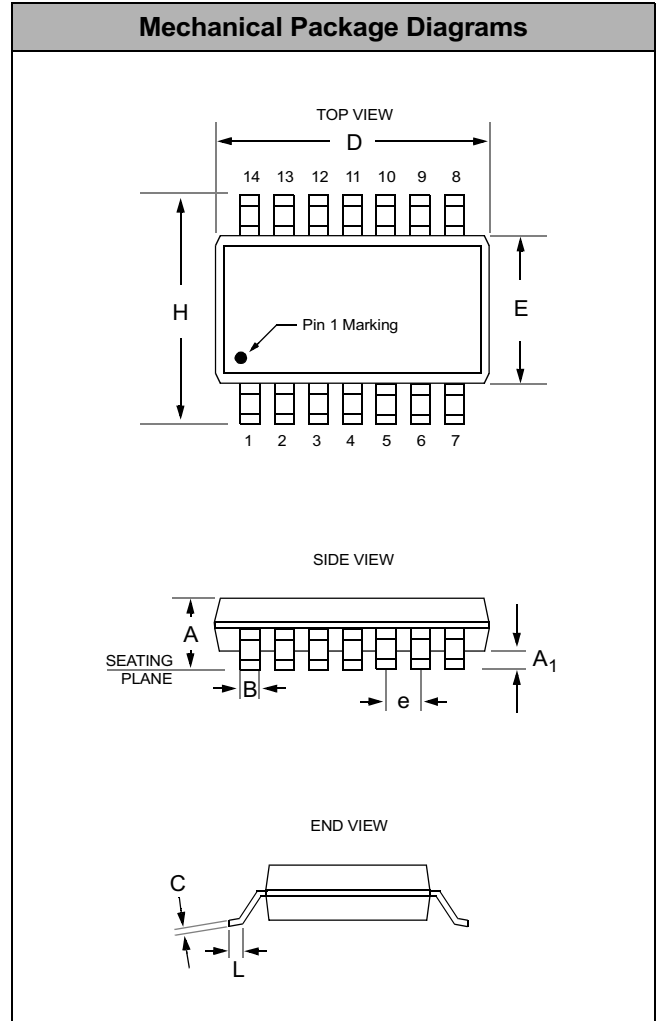

Package Dimensions for SOIC-14



Mechanical Details (continued)

SOIC-16 (Narrow) Mechanical Specifications

Dimensions for PRN101/111 devices packaged in 16-pin SOIC (Narrow) packages are presented below.

For complete information on the SOIC-16 (Narrow) package, see the California Micro Devices SOIC Package Information document.

PACKAGE DIMENSIONS				
Package	SOIC Narrow			
Pins	16			
Dimensions	Millimeters		Inches	
	Min	Max	Min	Max
A	1.35	1.75	0.053	0.069
A1	0.10	0.25	0.004	0.010
B	0.33	0.51	0.013	0.020
C	0.19	0.25	0.007	0.010
D	9.80	10.29	0.385	0.405
E	3.80	4.19	0.150	0.165
e	1.27 BSC		0.050 BSC	
H	5.80	6.20	0.228	0.244
L	0.40	1.27	0.016	0.050
# per tube	50 pieces*			
# per tape and reel	2500 pieces			
Controlling dimension: inches				

* This is an approximate amount which may vary.

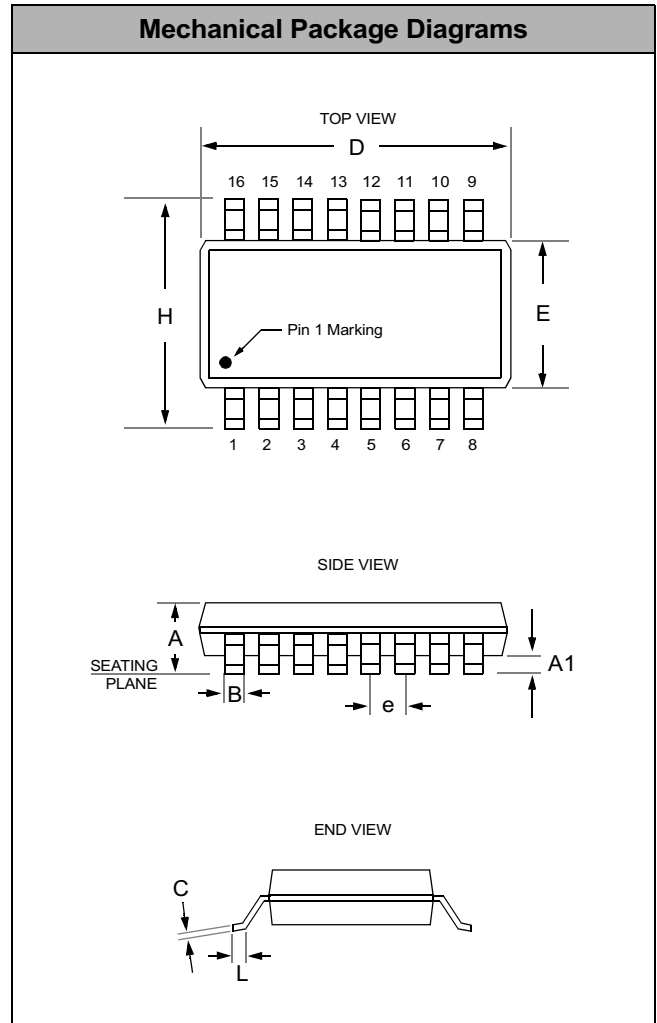

Package Dimensions for SOIC-16 (Narrow)

Mechanical Details (continued)

SOIC-16 (Wide) Mechanical Specifications

Dimensions for PRN101/111 devices packaged in 16-pin SOIC (Wide) packages are presented below.

For complete information on the SOIC-16 (Wide) package, see the California Micro Devices SOIC Package Information document.

PACKAGE DIMENSIONS				
Package	SOIC Wide			
Pins	16			
Dimensions	Millimeters		Inches	
	Min	Max	Min	Max
A	2.35	2.65	0.093	0.104
A1	0.10	0.30	0.004	0.012
B	0.33	0.51	0.013	0.020
C	0.23	0.32	0.009	0.013
D	10.11	10.50	0.398	0.413
E	7.40	7.87	0.291	0.310
e	1.27 BSC		0.050 BSC	
H	10.00	10.65	0.394	0.419
L	0.40	1.27	0.015	0.050
# per tube	48 pieces*			
# per tape and reel	1000 pieces			
Controlling dimension: inches				

* This is an approximate amount which may vary.

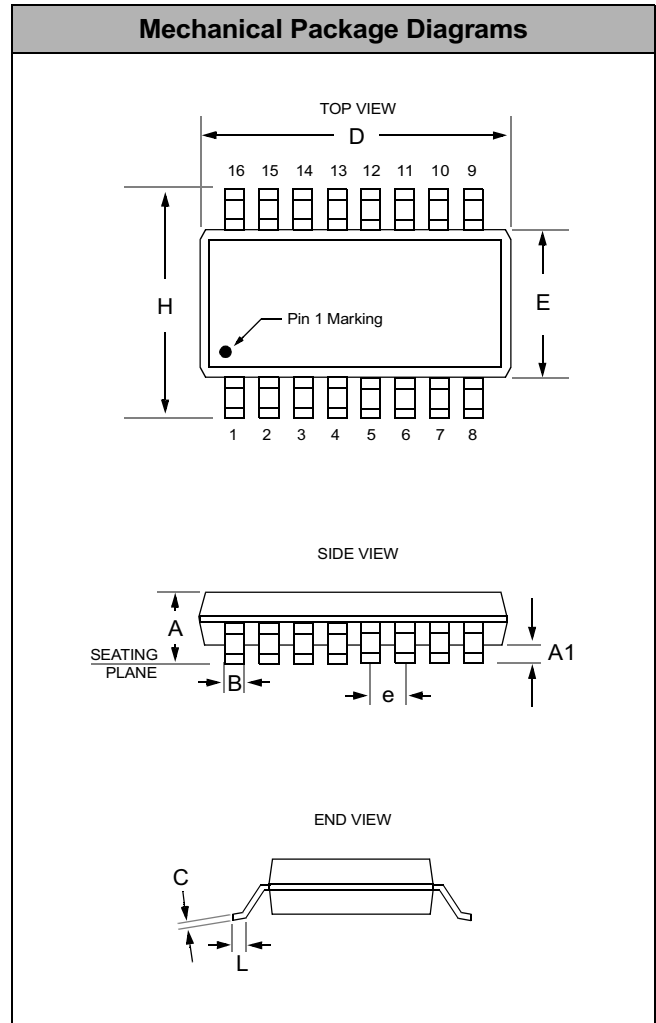

Package Dimensions for SOIC-16 (Wide)



Mechanical Details (continued)

SOIC-20 Mechanical Specifications

Dimensions for PRN101/111 devices packaged in 20-pin SOIC packages are presented below.

For complete information on the SOIC-20 package, see the California Micro Devices SOIC Package Information document.

PACKAGE DIMENSIONS				
Package	SOIC			
Pins	20			
Dimensions	Millimeters		Inches	
	Min	Max	Min	Max
A	2.35	2.85	0.093	0.104
A1	0.10	0.30	0.004	0.012
B	0.33	0.51	0.013	0.020
C	0.23	0.32	0.009	0.013
D	12.60	13.21	0.496	0.520
E	7.40	7.87	0.291	0.310
e	1.27 BSC		0.050 BSC	
H	10.00	10.65	0.394	0.419
L	0.40	1.27	0.015	0.050
# per tube	38 pieces*			
# per tape and reel	1000 pieces			
Controlling dimension: inches				

* This is an approximate amount which may vary.

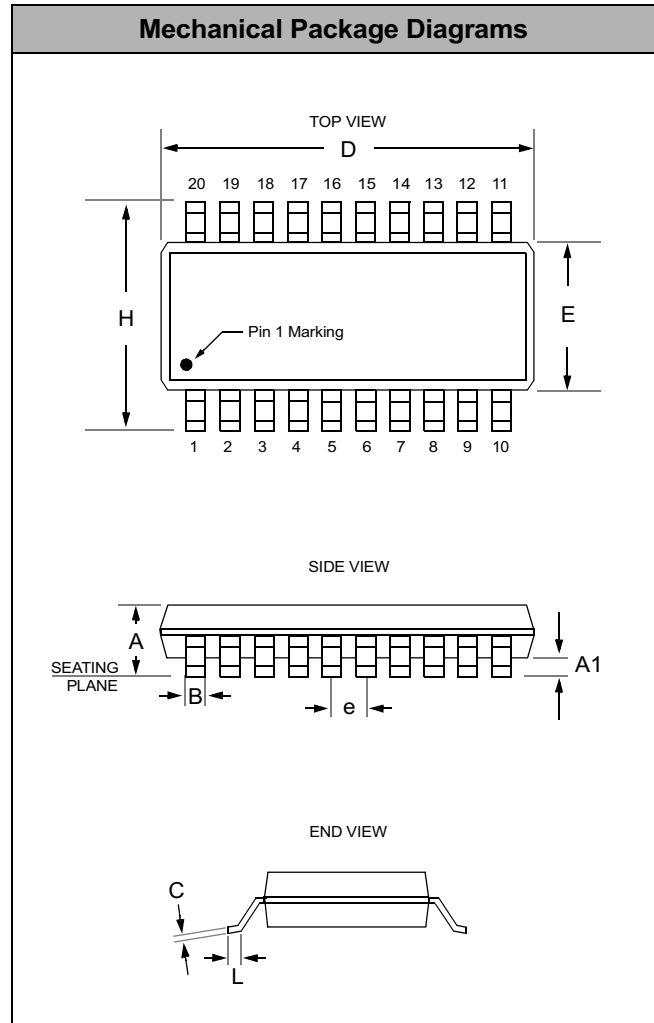

Package Dimensions for SOIC-20

Mechanical Details (continued)

QSOP-16 Mechanical Specifications

Dimensions for PRN101/111 devices packaged in 16-pin QSOP packages are presented below.

For complete information on the QSOP-16 package, see the California Micro Devices QSOP Package Information document.

PACKAGE DIMENSIONS				
Package	QSOP (JEDEC name is SSOP)			
Pins	16			
Dimensions	Millimeters		Inches	
	Min	Max	Min	Max
A	1.35	1.75	0.053	0.069
A1	0.10	0.25	0.004	0.010
B	0.20	0.30	0.008	0.012
C	0.18	0.25	0.007	0.010
D	4.80	5.00	0.189	0.197
E	3.81	3.98	0.150	0.157
e	0.64 BSC		0.025 BSC	
H	5.79	6.19	0.228	0.244
L	0.40	1.27	0.016	0.050
# per tube	100 pieces*			
# per tape and reel	2500 pieces			
Controlling dimension: inches				

* This is an approximate amount which may vary.

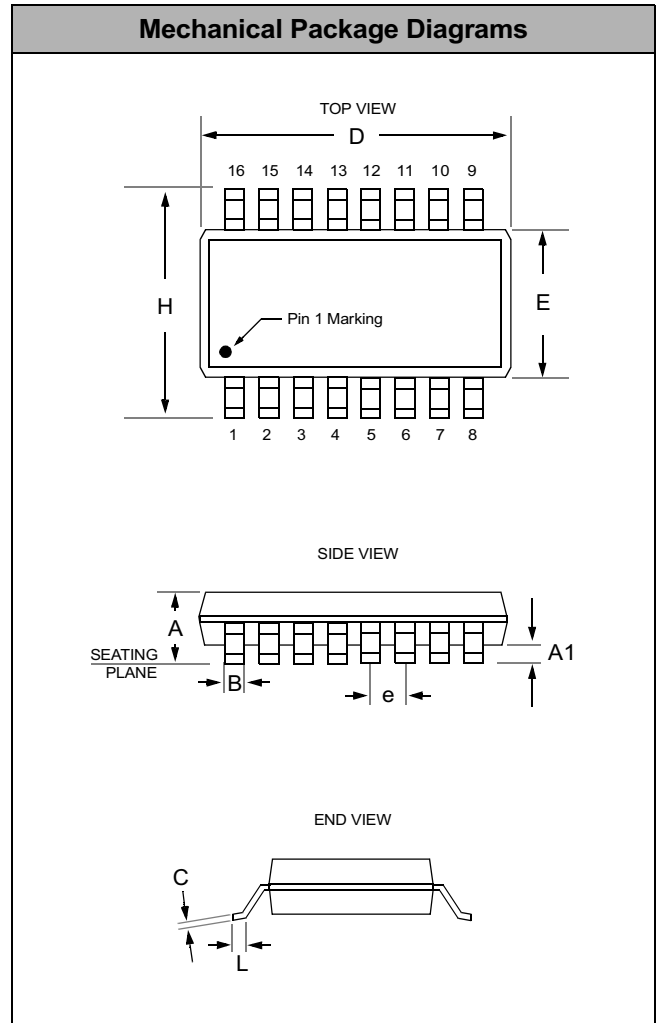

Package Dimensions for QSOP-16

Mechanical Details (continued)

QSOP-20 Mechanical Specifications

Dimensions for PRN101/111 devices packaged in 20-pin QSOP packages are presented below.

For complete information on the QSOP-20 package, see the California Micro Devices QSOP Package Information document.

PACKAGE DIMENSIONS				
Package	QSOP (JEDEC name is SSOP)			
Pins	20			
Dimensions	Millimeters		Inches	
	Min	Max	Min	Max
A	1.35	1.75	0.053	0.069
A1	0.10	0.25	0.004	0.010
B	0.20	0.30	0.008	0.012
C	0.18	0.25	0.007	0.010
D	8.56	8.73	0.337	0.344
E	3.81	3.98	0.150	0.157
e	0.64 BSC		0.025 BSC	
H	5.79	6.19	0.228	0.244
L	0.40	1.27	0.016	0.050
# per tube	57 pieces*			
# per tape and reel	2500 pieces			
Controlling dimension: inches				

* This is an approximate amount which may vary.

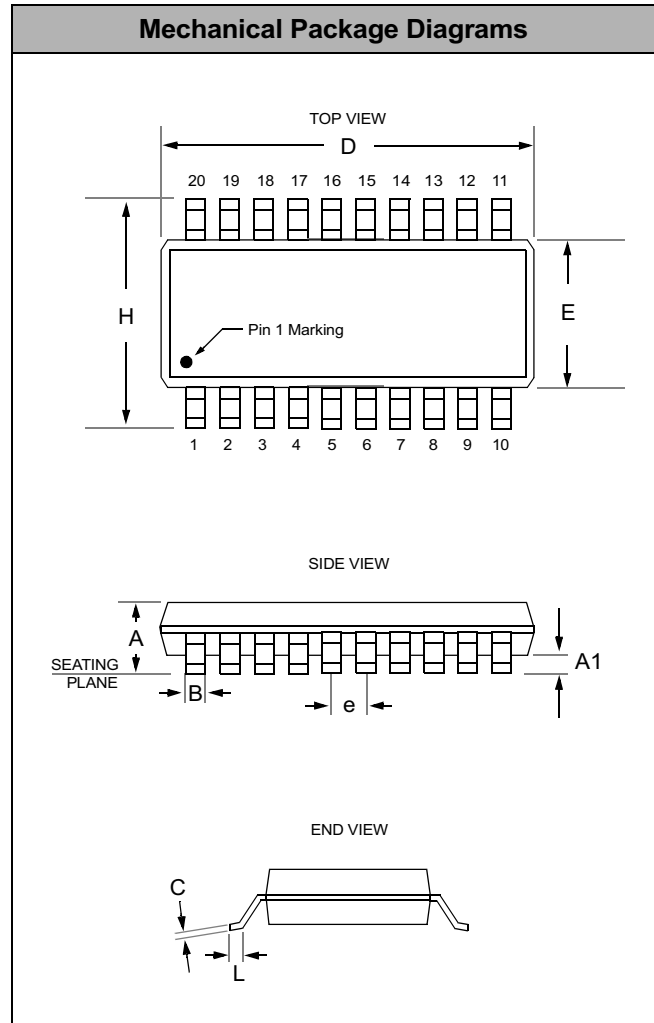

Package Dimensions for QSOP-20



Mechanical Details (continued)

QSOP-24 Mechanical Specifications

Dimensions for PRN101/111 devices packaged in 24-pin QSOP packages are presented below.

For complete information on the QSOP-24 package, see the California Micro Devices QSOP Package Information document.

PACKAGE DIMENSIONS				
Package	QSOP (JEDEC name is SSOP)			
Pins	24			
Dimensions	Millimeters		Inches	
	Min	Max	Min	Max
A	1.35	1.75	0.053	0.069
A1	0.10	0.25	0.004	0.010
B	0.20	0.30	0.008	0.012
C	0.18	0.25	0.007	0.010
D	8.56	8.73	0.337	0.344
E	3.81	3.98	0.150	0.157
e	0.64 BSC		0.025 BSC	
H	5.79	6.19	0.228	0.244
L	0.40	1.27	0.016	0.050
# per tube	55 pieces*			
# per tape and reel	2500 pieces			
Controlling dimension: inches				

* This is an approximate amount which may vary.

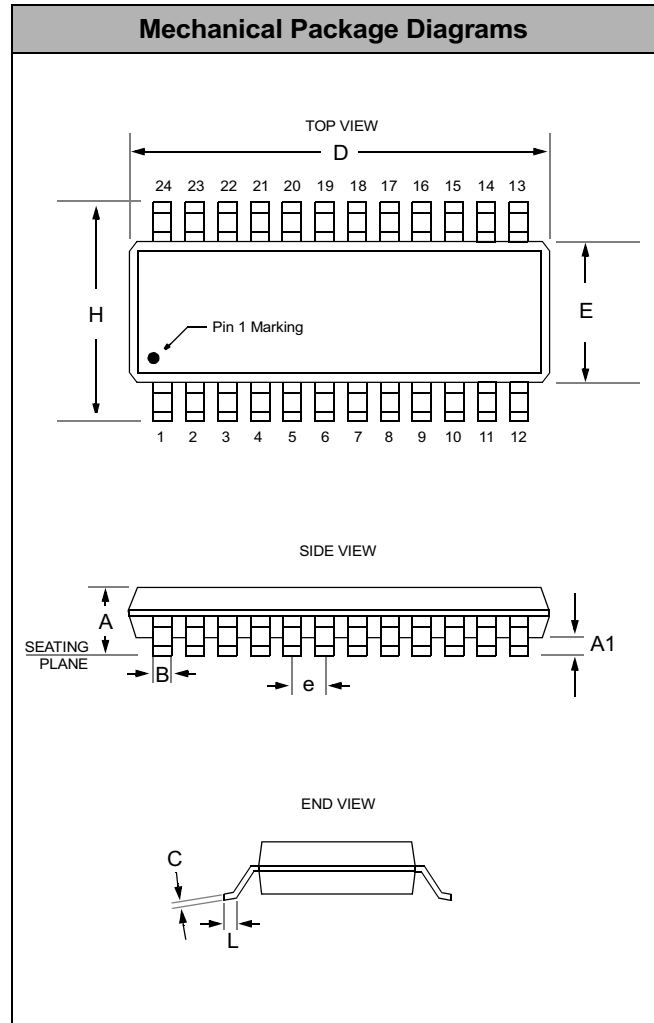

Package Dimensions for QSOP-24