

GMCR100-6

SENSITIVE GATE SILICON CONTROLLED RECTIFIERS REVERSE BLOCKING THYRISTORS 0.8A, 400V

Description

The GMCR100-6 PNP device is designed for high volume, line-powered applications such as relay and lamp drivers, small motor controls, gate drivers for larger thyristors, and sensing and detection circuits.

Supplied in an inexpensive plastic TO-92 package which is readily adaptable for use in automatic insertion equipment.

Features

- Sensitive Gate Allows Triggering by Microcontrollers and Other Logic Circuits
- On-state Current Rating of 0.8A RMS at 80°C
- High Surge Current Capability 10A
- Minimum and Maximum Values of IGT, VGT and IH Specified for Ease of Design
- Immunity to dV/dt - 20 V/μsec Minimum at 110°C
- Glass-Passivated Surface for Reliability and Uniformity

Package Dimensions

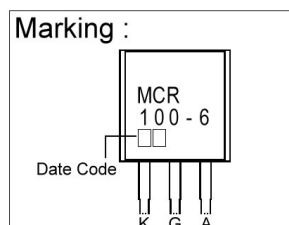
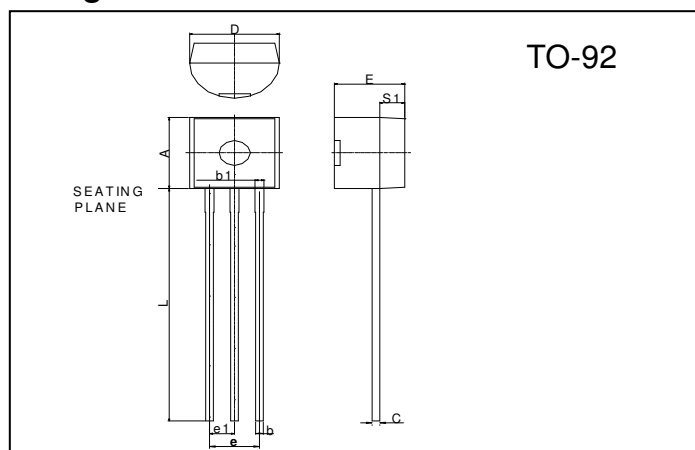

REF.	Millimeter		REF.	Millimeter	
	Min.	Max.		Min.	Max.
A	4.45	4.7	D	4.44	4.7
S1	1.02	-	E	3.30	3.81
b	0.36	0.51	L	12.70	-
b1	0.36	0.76	e1	1.150	1.390
C	0.36	0.51	e	2.42	2.66

Absolute Maximum Ratings (T_J=25°C unless otherwise noted)

Rating	Symbol	Value	Unit
Peak Repetitive Off-State Voltage(Note1) (T _J =-40 to 110°C, Sine Wave, 50 to 60Hz; Gate open)	V _{DRM} V _{RDM}	400	V
On-state RMS Current, (T _C =80°C) 180° Conduction Angles	I _{T(RMS)}	0.8	A
Peak Non-Repetitive Surge Current (1/2 Cycle, Sine Wave, 60Hz, T _J =25°C)	I _{TSM}	10	A
Circuit Fusing Consideration (t=8.3ms)	I ² _t	0.415	A ² s
Forward Peak Gate Power (T _A =25°C, Pulse Width ≤ 1.0μs)	P _{GM}	100	mW
Forward Average Gate Power (T _A =25°C, t=8.3ms)	P _{G(AV)}	10	mW
Forward Peak Gate Current (T _A =25°C, Pulse Width ≤ 1.0μs)	I _{GM}	1.0	A
Reverse Peak Gate Voltage (T _A =25°C, Pulse Width ≤ 1.0μs)	V _{GRM}	5.0	V
Operating Junction Temperature Rang @ Rate V _{RDM} and V _{DRM}	T _J	-40 ~ +110	°C
Storage Temperature Range	T _{stg}	-40 ~ +150	°C

Maximum ratings are those values beyond which device damage can occur. Maximum ratings applied to the device are individual stress limit values (not normal operating conditions) and are not valid simultaneously. If these limits are exceeded, device function operation is not implied, damage may occur and reliability may be affected.

Note 1. V_{DRM} and V_{RDM} for all types can be applied on a continuous basis. Ratings apply for zero or negative gate voltage; however, positive gate voltage shall not be applied concurrent with negative potential on the anode. Blocking voltages shall not be tested with a constant current source such that the voltage ratings of the devices are exceeded.

Thermal Characteristics

Characteristic	Symbol	Max	Unit
Thermal Resistance, Junction-to-case	$R_{\theta JC}$	75	$^{\circ}C/W$
Junction-to-Ambient	$R_{\theta JA}$	200	$^{\circ}C/W$
Lead Solder Temperature (< 1/16" from case, 10 secs max)	TL	260	$^{\circ}C$

Electrical Characteristics ($T_C = 25^{\circ}C$ unless otherwise noted)

Characteristic	Symbol	Min	Typ	Max	Unit
Off Characteristics					
Peak Repetitive Forward or Reverse Blocking Current (Note2) ($V_{DRM}=400V$ and $V_{RRM}=400V$; $R_{GK}=1k\Omega$)	I_{DRM}, I_{RRM}	-	-	10 100	μA
					$T_C=25^{\circ}C$ $T_C=110^{\circ}C$
On Characteristics					
Peak Forward On-State Voltage* ($I_{TM}=1A$ Peak @ $T_A=25^{\circ}C$)	V_{TM}	-	-	1.7	V
Gate Trigger Current (Continuous dc) (Note3) ($V_{AK}=7.0$ Vdc, $R_L=100\Omega$)	I_{GT}	-	50	100	μA
Holding Current (Note2) ($V_{AK}=7.0$ Vdc, Initiating Current=20mA)	I_H	-	0.5 -	5.0 10	mA
Latch Current ($V_{AK}=7.0$ Vdc, $I_g=200\mu A$)	I_L	-	0.6 -	10 15	mA
Gate Trigger Voltage (Continuous dc) (Note3) ($V_{AK}=7.0$ Vdc, $R_L=100\Omega$)	V_{GT}	-	0.62 -	0.8 1.2	V
					$T_C=25^{\circ}C$ $T_C=-40^{\circ}C$
Dynamic Characteristics					
Critical Rate of Rise of Off-State Voltage ($V_D=400V$, Exponential Waveform, $R_{GK}=1000\Omega$, $T_J=110^{\circ}C$)	dV/dt	20	35	-	$V/\mu s$
Critical Rate of Rise of Off-State Current ($I_{PK}=20AV$, $PW=10\mu sec$; $di/dt=1A/\mu sec$, $I_{gt}=20mA$)	di/dt	-	-	50	$A/\mu s$

*Indicates Pulse Test: Pulse Width $\leq 1.0ms$, Duty Cycle $\leq 1\%$.

Note 2. $R_{GK}=1000\Omega$ included in measurement.

Note 3. Dose not include R_{GK} in measurement.

Voltage Current Characteristic of SCR

Symbol	Parameter
V_{DRM}	Peak Repetitive Off State Forward Voltage
I_{DRM}	Peak Forward Blocking Current
V_{RRM}	Peak Repetitive Off State Reverse Voltage
I_{RRM}	Peak Reverse Blocking Current
V_{TM}	Peak On State Voltage
I_H	Holding Current

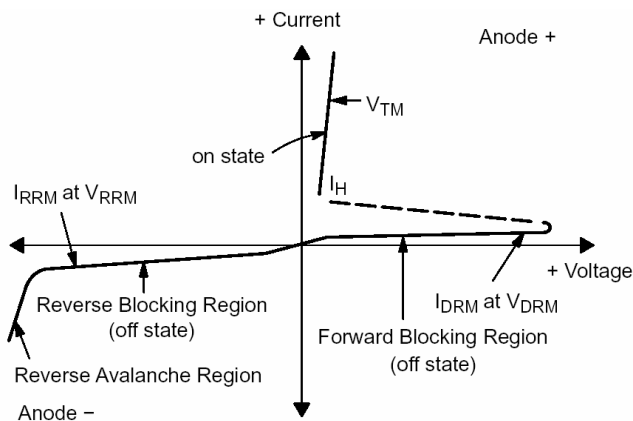

Characteristics Curve

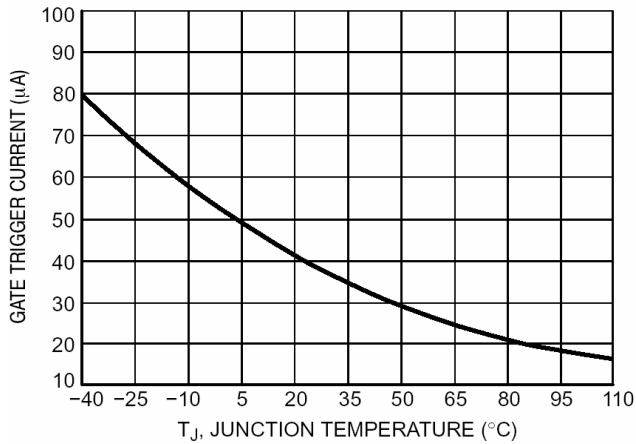

Fig 1. Typical Gate Trigger Current v.s. Junction Temperature

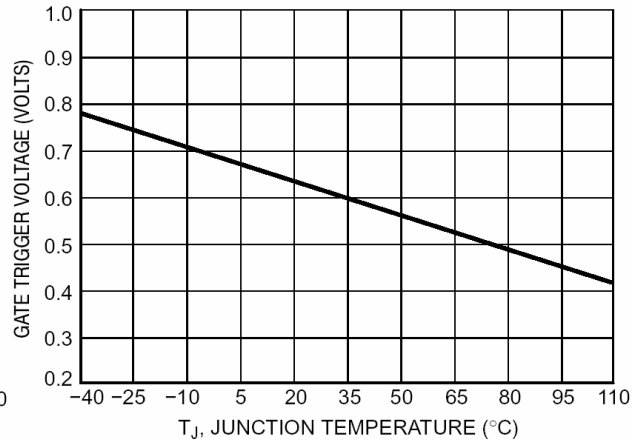

Fig 2. Typical Gate Trigger Voltage v.s. Junction Temperature

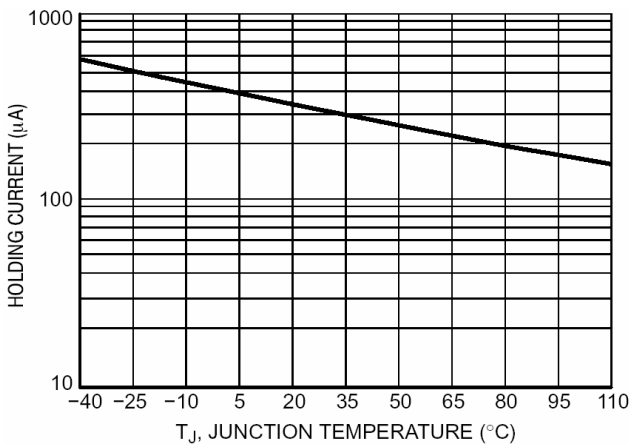

Fig 3. Typical Holding Current v.s. Junction Temperature

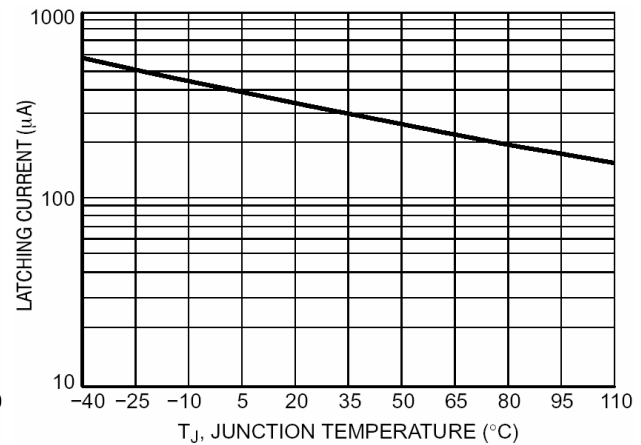

Fig 4. Typical Latching Current v.s. Junction Temperature

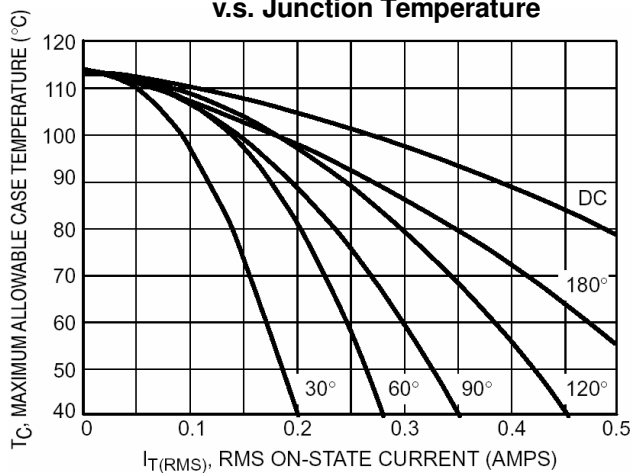

Fig 5. Typical RMS Current Derating

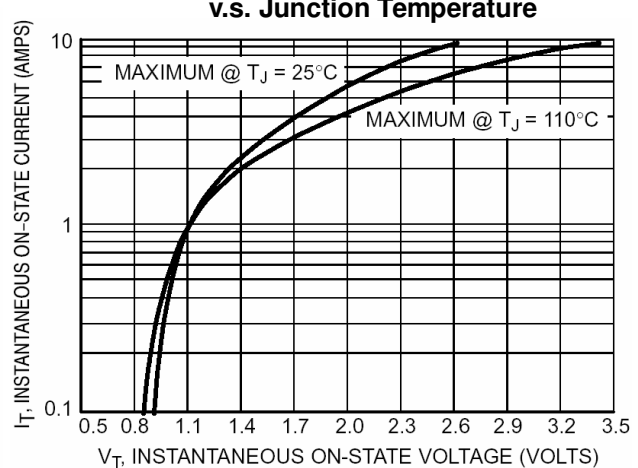

Fig 6. Typical On-State Characteristic

Important Notice:

- All rights are reserved. Reproduction in whole or in part is prohibited without the prior written approval of GTM.
- GTM reserves the right to make changes to its products without notice.
- GTM semiconductor products are not warranted to be suitable for use in life-support Applications, or systems.
- GTM assumes no liability for any consequence of customer product design, infringement of patents, or application assistance.

Head Office And Factory:

- Taiwan:** No. 17-1 Tatung Rd. Fu Kou Hsin-Chu Industrial Park, Hsin-Chu, Taiwan, R. O. C.
- TEL : 886-3-597-7061 FAX : 886-3-597-9220, 597-0785
- China:** (201203) No.255, Jang-Jiang Tsai-Lueng RD. , Pu-Dung-Hsin District, Shang-Hai City, China
- TEL : 86-21-5895-7671 ~ 4 FAX : 86-21-38950165