

MITSUBISHI TRANSISTOR MODULES  
**QM30E2Y/E3Y-H**

MEDIUM POWER SWITCHING USE  
 INSULATED TYPE

QM30E2Y/E3Y-H



- **IC** Collector current ..... **30A**
- **VCEX** Collector-emitter voltage ..... **600V**
- **hFE** DC current gain ..... **75**
- **Insulated Type**
- **UL Recognized**

Yellow Card No. E80276 (N)  
 File No. E80271

**APPLICATION**

DC chopper, DC motor controllers, Inverters

**OUTLINE DRAWING & CIRCUIT DIAGRAM**

Dimensions in mm

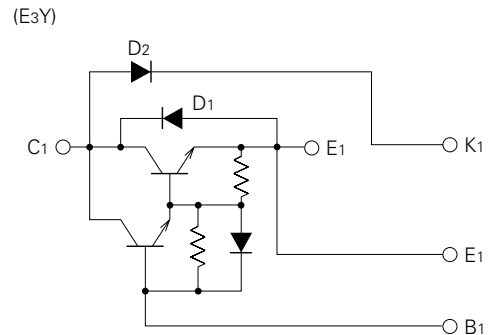
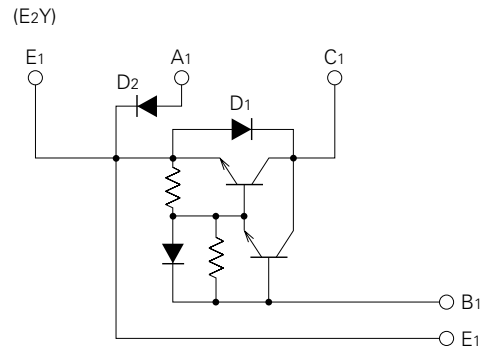
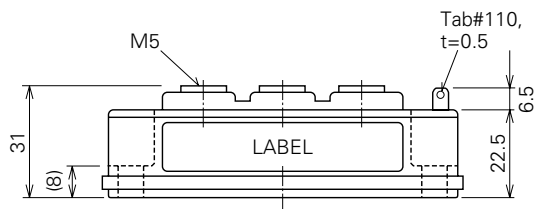
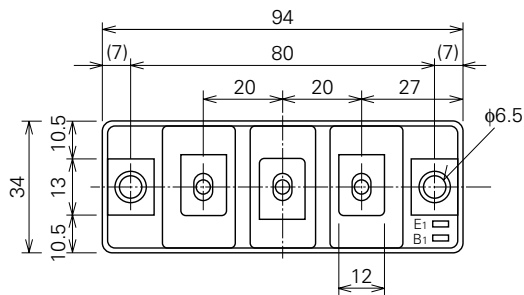

**QM30E2Y/E3Y-H**

**MEDIUM POWER SWITCHING USE  
INSULATED TYPE**

**ABSOLUTE MAXIMUM RATINGS** (Transistor part including D1,  $T_j=25^\circ\text{C}$ )

| Symbol     | Parameter   | Conditions                                  | Ratings | Unit |
|------------|---|---|---------|------|
| VCEX (SUS) | Collector-emitter voltage                               | $I_C=1\text{A}$ , $V_{EB}=2\text{V}$        | 600     | V    |
| VCEX       | Collector-emitter voltage                               | $V_{EB}=2\text{V}$                          | 600     | V    |
| VCBO       | Collector-base voltage                                  | Emitter open                                | 600     | V    |
| VEBO       | Emitter-base voltage                                    | Collector open                              | 7       | V    |
| $I_C$      | Collector current                                       | DC  | 30      | A    |
| $-I_C$     | Collector reverse current                               | DC (forward diode current)                  | 30      | A    |
| PC         | Collector dissipation                                   | $T_c=25^\circ\text{C}$                      | 250     | W    |
| $I_B$      | Base current  | DC  | 1.8     | A    |
| $-I_{CSM}$ | Surge collector reverse current (forward diode current) | Peak value of one cycle of 60Hz (half wave) | 300     | A    |

**ABSOLUTE MAXIMUM RATINGS** (Diode part (D2),  $T_j=25^\circ\text{C}$ )

| Symbol    | Parameter                              | Conditions                                  | Ratings           | Unit                 |
|-----------|--|---|-------------------|----------------------|
| VRRM      | Repetitive peak reverse voltage        |   | 600               | V                    |
| VRSM      | Non-repetitive peak reverse voltage    |   | 720               | V                    |
| VR (DC)   | DC reverse voltage                     |   | 480               | V                    |
| $I_{DC}$  | DC current                             | DC circuit, resistive, inductive load       | 30                | A                    |
| $I_{FSM}$ | Surge (non-repetitive) forward current | Peak value of one cycle of 60Hz (half wave) | 600               | A                    |
| $I^2t$    | $I^2t$ for fusing                      | Value for one cycle of surge current        | $1.5 \times 10^3$ | $\text{A}^2\text{s}$ |

**ABSOLUTE MAXIMUM RATINGS** (Common)

| Symbol    | Parameter            | Conditions                            | Ratings        | Unit             |
|-----------|----------------------|---------------------------------------|----------------|------------------|
| $T_j$     | Junction temperature |                                       | $-40 \sim 150$ | $^\circ\text{C}$ |
| $T_{stg}$ | Storage temperature  |                                       | $-40 \sim 125$ | $^\circ\text{C}$ |
| $V_{iso}$ | Isolation voltage    | Charged part to case, AC for 1 minute | 2500           | V                |
| —         | Mounting torque      | Main terminal screw M5                | 1.47~1.96      | N·m              |
|           |                      |                                       | 15~20          | kg·cm            |
|           |                      | Mounting screw M6                     | 1.96~2.94      | N·m              |
|           |                      |                                       | 20~30          | kg·cm            |
| —         | Weight               | Typical value                         | 210            | g                |

**ELECTRICAL CHARACTERISTICS** (Transistor part including D1,  $T_j=25^\circ\text{C}$ )

| Symbol         | Parameter                                | Test conditions  | Limits |      |      | Unit                      |
|----------------|--|--|--------|------|------|---------------------------|
|                |  |  | Min.   | Typ. | Max. |                           |
| $I_{CEX}$      | Collector cutoff current                 | $V_{CE}=600\text{V}$ , $V_{EB}=2\text{V}$                              | —      | —    | 1.0  | mA                        |
| $I_{CBO}$      | Collector cutoff current                 | $V_{CB}=600\text{V}$ , Emitter open                                    | —      | —    | 1.0  | mA                        |
| $I_{EBO}$      | Emitter cutoff current                   | $V_{EB}=7\text{V}$   | —      | —    | 200  | mA                        |
| $V_{CE(sat)}$  | Collector-emitter saturation voltage     | $I_C=30\text{A}$ , $I_B=0.4\text{A}$                                   | —      | —    | 2.0  | V                         |
| $V_{BE(sat)}$  | Base-emitter saturation voltage          |  | —      | —    | 2.5  | V                         |
| $-V_{CEO}$     | Collector-emitter reverse voltage        | $-I_C=30\text{A}$ (diode forward voltage)                              | —      | —    | 1.85 | V                         |
| hFE            | DC current gain                          | $I_C=30\text{A}$ , $V_{CE}=2\text{V}/5\text{V}$                        | 75/100 | —    | —    | —                         |
| $t_{on}$       | Switching time                           | $V_{CC}=300\text{V}$ , $I_C=30\text{A}$ , $I_{B1}=-I_{B2}=0.6\text{A}$ | —      | —    | 1.5  | $\mu\text{s}$             |
| $t_s$          |  |  | —      | —    | 12   | $\mu\text{s}$             |
| $t_f$          |  |  | —      | —    | 3.0  | $\mu\text{s}$             |
| $R_{th(j-c)Q}$ | Thermal resistance (junction to case)    | Transistor part  | —      | —    | 0.5  | $^\circ\text{C}/\text{W}$ |
| $R_{th(j-c)R}$ |  | Diode part   | —      | —    | 2.0  | $^\circ\text{C}/\text{W}$ |
| $R_{th(c-f)}$  | Contact thermal resistance (case to fin) | Conductive grease applied  | —      | —    | 0.15 | $^\circ\text{C}/\text{W}$ |

**QM30E2Y/E3Y-H**

MEDIUM POWER SWITCHING USE  
INSULATED TYPE

**ELECTRICAL CHARACTERISTICS** (Diode part (D2),  $T_j=25^\circ\text{C}$ )

| Symbol        | Parameter                       | Test conditions   | Limits |      |      | Unit                      |
|---------------|---------------------------------|---|--------|------|------|---------------------------|
|               |                                 |   | Min.   | Typ. | Max. |                           |
| $I_{RRM}$     | Repetitive peak reverse current | $V_R=V_{RRM}, T_j=150^\circ\text{C}$  | —      | —    | 5.0  | mA                        |
| $V_{FM}$      | Forward voltage                 | $I_F=30\text{A}$  | —      | —    | 1.5  | V                         |
| $t_{rr}$      | Reverse recovery time           | $I_F=30\text{A}, di/dt=-60\text{A}/\mu\text{s}, V_R=600\text{V}, T_j=150^\circ\text{C}$ | —      | —    | 0.9  | $\mu\text{s}$             |
| $Q_{rr}$      | Reverse recovery charge         |   | —      | —    | 15   | $\mu\text{C}$             |
| $R_{th(j-c)}$ | Thermal resistance              | Junction to case  | —      | —    | 1.3  | $^\circ\text{C}/\text{W}$ |
| $R_{th(c-f)}$ | Contact thermal resistance      | Conductive grease applied (case to fin)   | —      | —    | 0.15 | $^\circ\text{C}/\text{W}$ |

**PERFORMANCE CURVES**

**COMMON EMITTER OUTPUT CHARACTERISTICS (TYPICAL)**

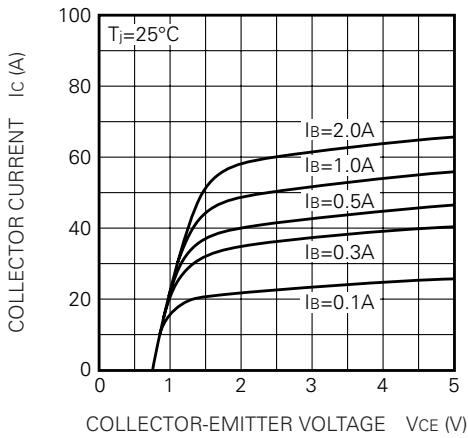

**DC CURRENT GAIN VS. COLLECTOR CURRENT (TYPICAL)**

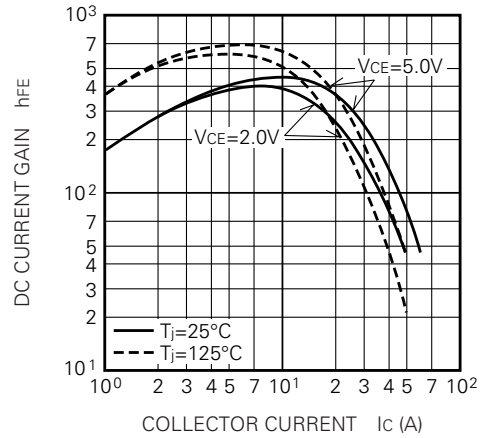

**COMMON EMITTER INPUT CHARACTERISTIC (TYPICAL)**

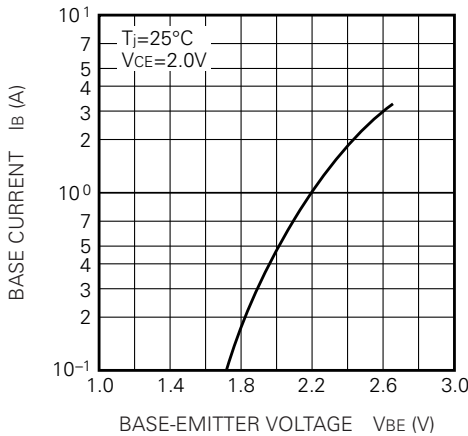

**SATURATION VOLTAGE CHARACTERISTICS (TYPICAL)**

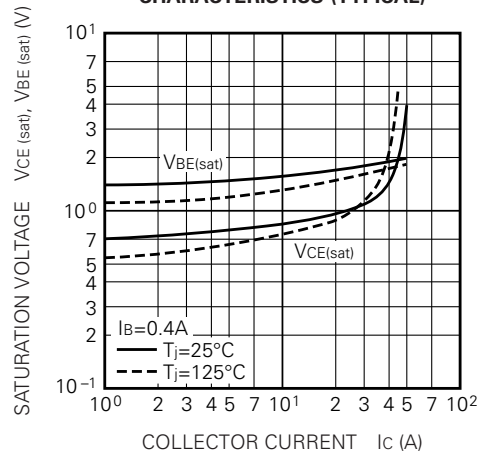

# QM30E2Y/E3Y-H

MEDIUM POWER SWITCHING USE  
INSULATED TYPE

**COLLECTOR-EMITTER SATURATION VOLTAGE (TYPICAL)**

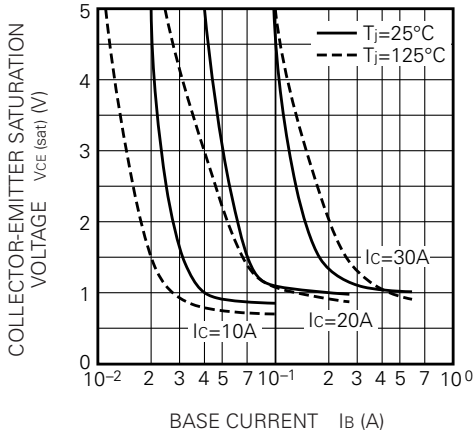

**SWITCHING TIME VS. COLLECTOR CURRENT (TYPICAL)**

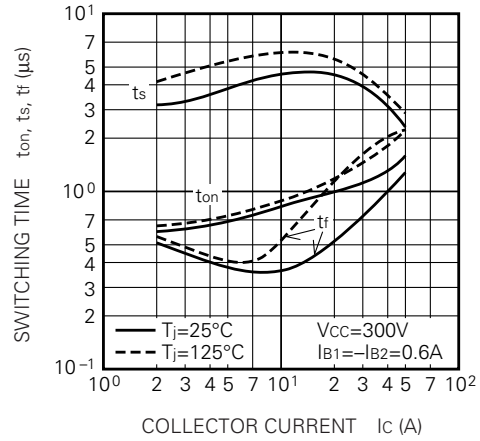

**SWITCHING TIME VS. BASE CURRENT (TYPICAL)**

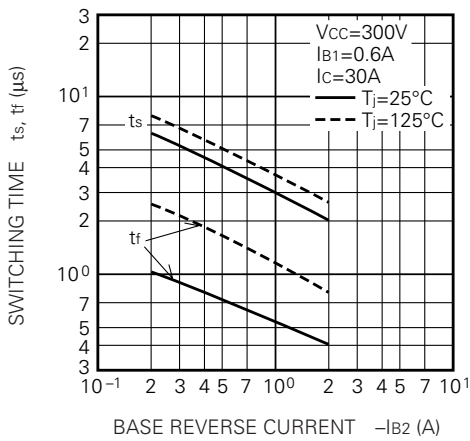

**REVERSE BIAS SAFE OPERATING AREA**

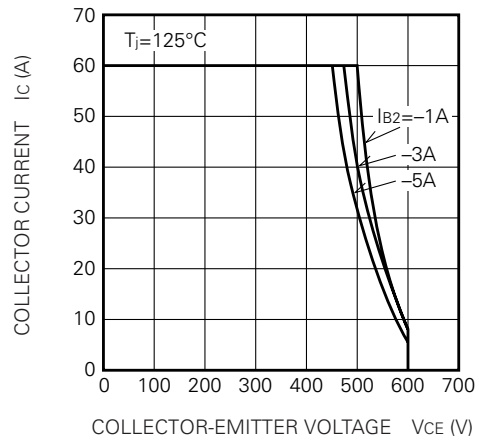

**FORWARD BIAS SAFE OPERATING AREA**

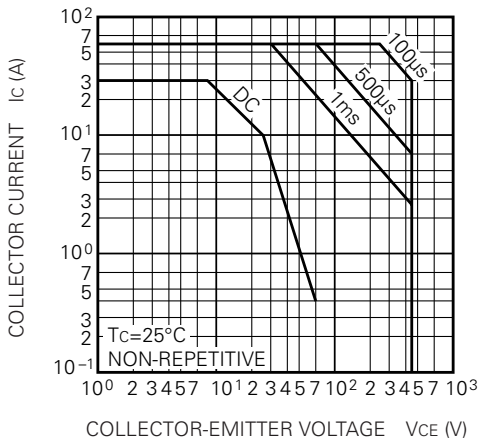

**DERATING FACTOR OF F. B. S. O. A.**

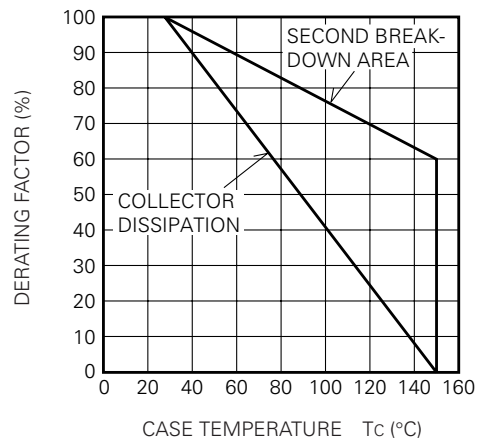

QM30E2Y/E3Y-H

MEDIUM POWER SWITCHING USE  
INSULATED TYPE

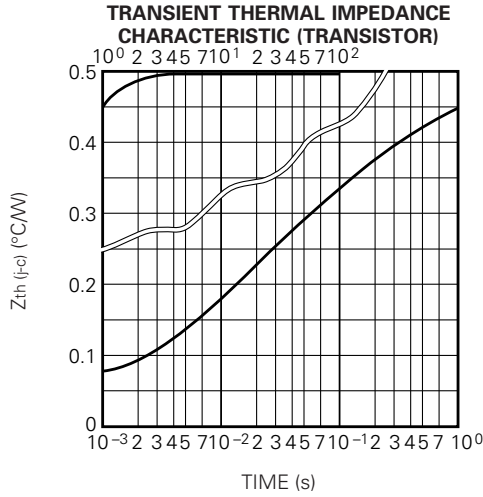

**PERFORMANCE CURVES (Diode part (D1))**

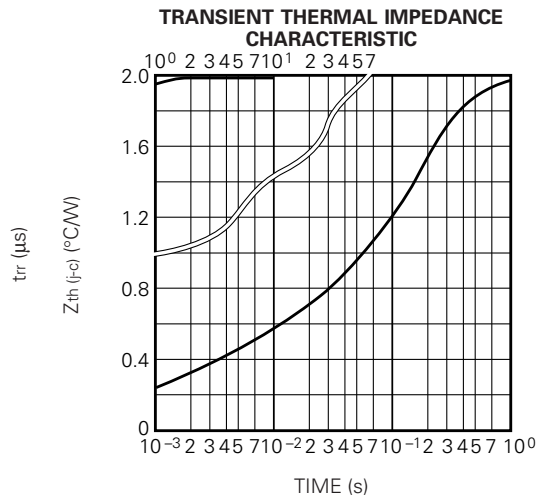
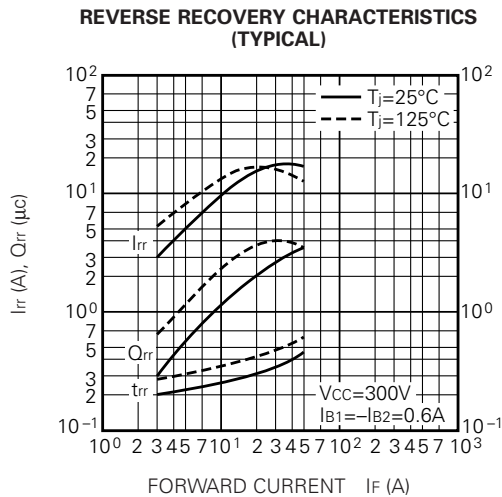
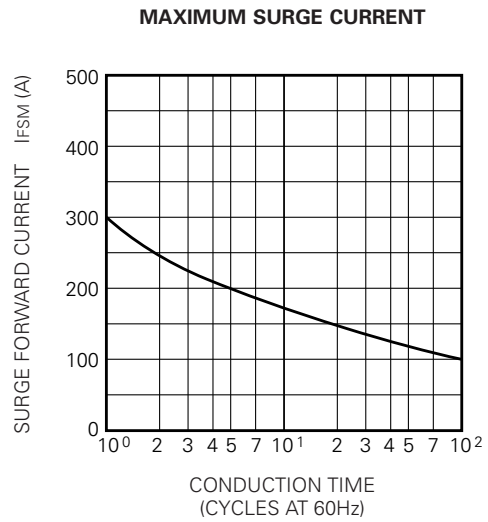
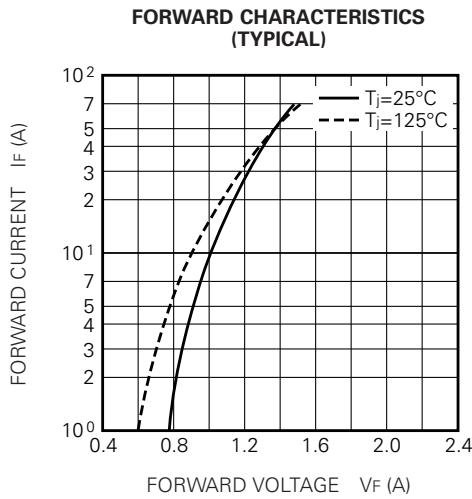

QM30E2Y/E3Y-H

MEDIUM POWER SWITCHING USE  
INSULATED TYPE

PERFORMANCE CURVES (Diode part (D2))

MAXIMUM FORWARD CHARACTERISTIC

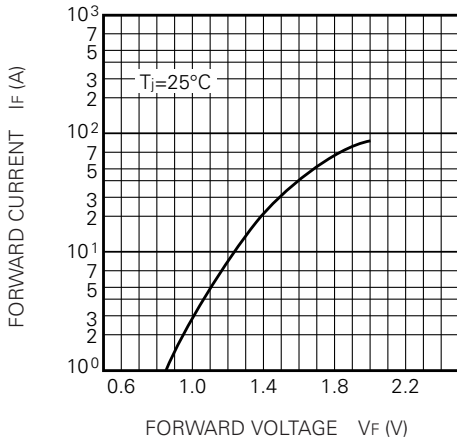

TRANSIENT THERMAL IMPEDANCE CHARACTERISTIC

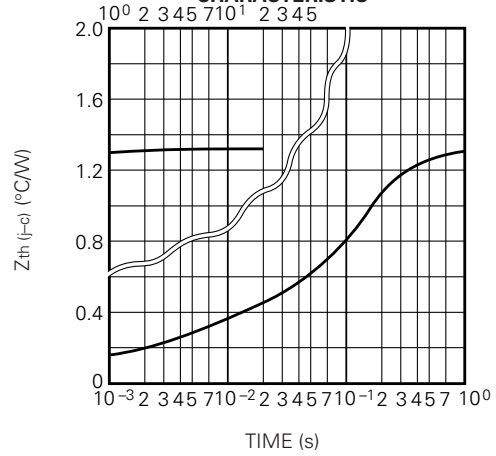

MAXIMUM SURGE CURRENT

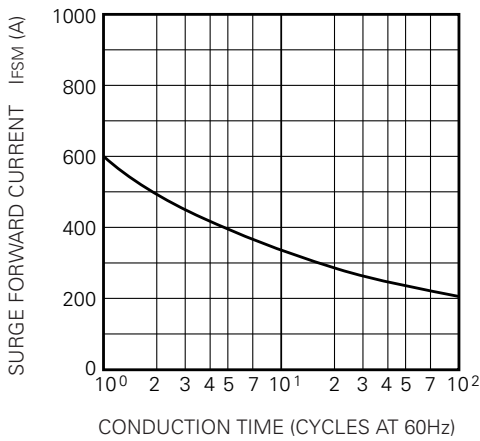

REVERSE RECOVERY CHARACTERISTICS (VS. IF) (TYPICAL)

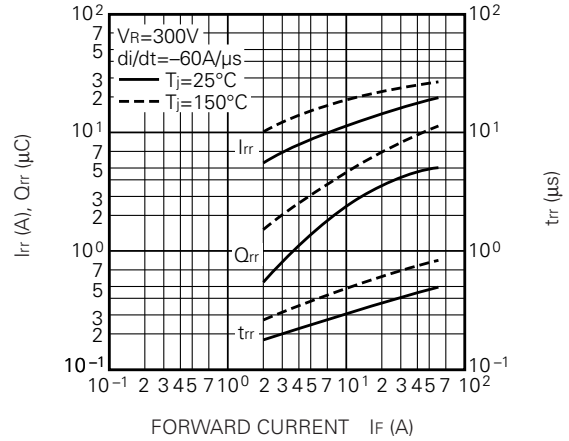

REVERSE RECOVERY CHARACTERISTICS (VS. di/dt) (TYPICAL)

