

2MBI150SC-120

IGBT Module

1200V / 150A 2 in one-package

■ Features

- High speed switching
- Voltage drive
- Low inductance module structure

■ Applications

- Inverter for Motor drive
- AC and DC Servo drive amplifier
- Uninterruptible power supply
- Industrial machines, such as Welding machines

■ Maximum ratings and characteristics

● Absolute maximum ratings (at Tc=25°C unless otherwise specified)

Item	Symbol	Rating	Unit	
Collector-Emitter voltage	V _{CEs}	1200	V	
Gate-Emitter voltage	V _{GES}	±20	V	
Collector current	Continuous	T _c =25°C	200	A
		T _c =80°C	150	A
	1ms	T _c =25°C	400	A
		T _c =80°C	300	A
	1ms	-I _c	150	A
	-I _c pulse	300	A	
Max. power dissipation	P _c	1000	W	
Operating temperature	T _j	+150	°C	
Storage temperature	T _{stg}	-40 to +125	°C	
Isolation voltage *1	V _{is}	AC 2500 (1min.)	V	
Screw torque	Mounting *2	3.5	N·m	
	Terminals *2	3.5	N·m	

*1 : All terminals should be connected together when isolation test will be done

*2 : Recommendable value : 2.5 to 3.5 N·m(M5)

● Electrical characteristics (at Tj=25°C unless otherwise specified)

Item	Symbol	Characteristics			Conditions	Unit
		Min.	Typ.	Max.		
Zero gate voltage collector current	I _{CEs}	–	–	2.0	V _{GE} =0V, V _{CE} =1200V	mA
Gate-Emitter leakage current	I _{GES}	–	–	0.4	V _{CE} =0V, V _{GE} =±20V	μA
Gate-Emitter threshold voltage	V _{GE(th)}	5.5	7.2	8.5	V _{CE} =20V, I _c =150mA	V
Collector-Emitter saturation voltage	V _{CE(sat)}	–	2.3	2.6	T _c =25°C, V _{GE} =15V, I _c =150A	V
		–	2.8	–	T _c =125°C	
Input capacitance	C _{ies}	–	18000	–	V _{GE} =0V	pF
Output capacitance	C _{oes}	–	3750	–	V _{CE} =10V	
Reverse transfer capacitance	C _{res}	–	3300	–	f=1MHz	
Turn-on time	t _{on}	–	0.35	1.2	V _{CC} =600V	μs
	t _r	–	0.25	0.6	I _c =150A	
	t _{r(i)}	–	0.1	–	V _{GE} =±15V	
Turn-off time	t _{off}	–	0.45	1.0	R _G =5.6 ohm	μs
	t _f	–	0.08	0.3		
Forward on voltage	V _F	–	2.3	3.0	T _j =25°C, I _F =150A, V _{GE} =0V	V
		–	2.0	–	T _j =125°C	
Reverse recovery time	t _{rr}	–	–	0.35	I _F =150A	μs

● Thermal resistance characteristics

Item	Symbol	Characteristics			Conditions	Unit
		Min.	Typ.	Max.		
Thermal resistance	R _{th(j-c)}	–	–	0.125	IGBT	°C/W
	R _{th(j-c)}	–	–	0.26	Diode	°C/W
	R _{th(c-f)*2}	–	0.025	–	the base to cooling fin	°C/W

*2 : This is the value which is defined mounting on the additional cooling fin with thermal compound



■ Equivalent Circuit Schematic

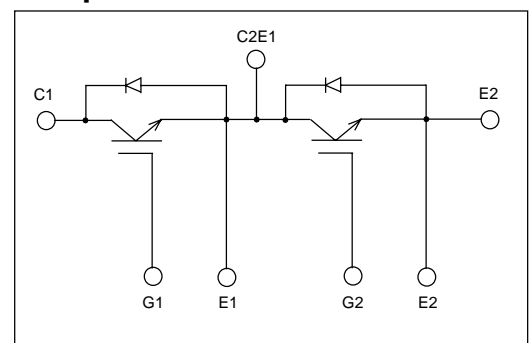

Characteristics (Representative)

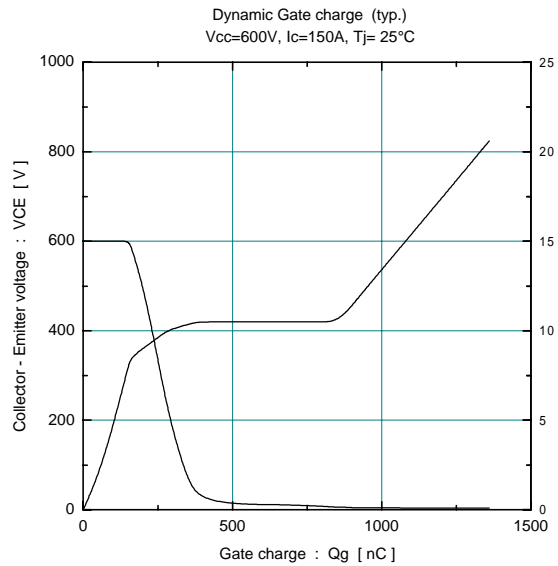
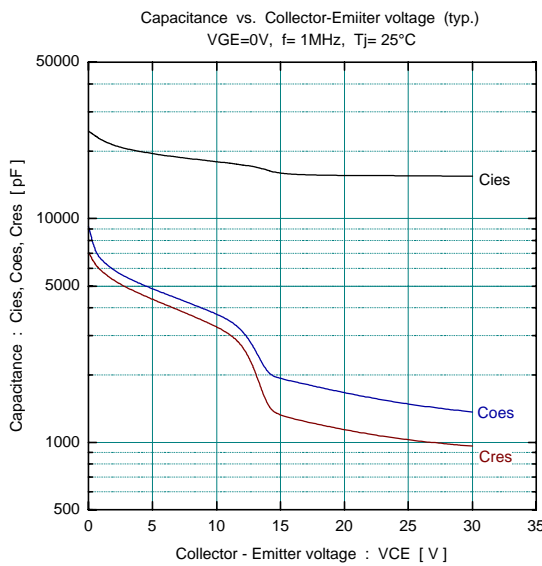
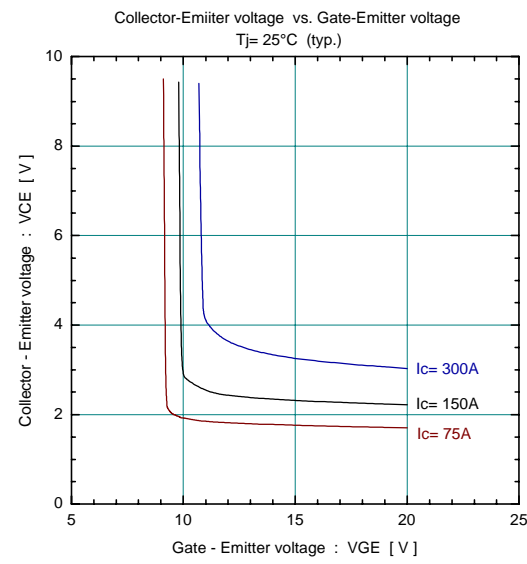
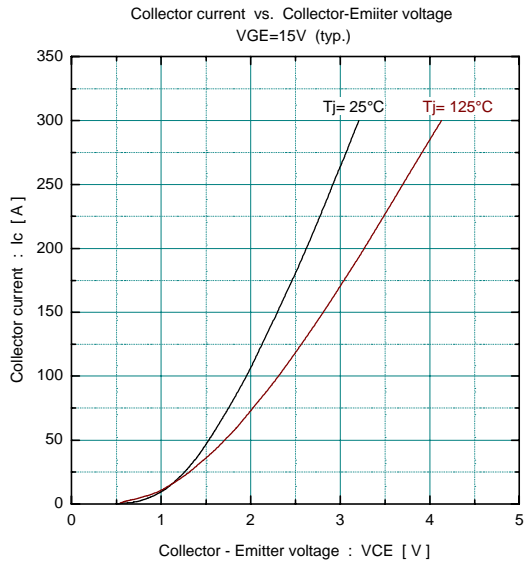
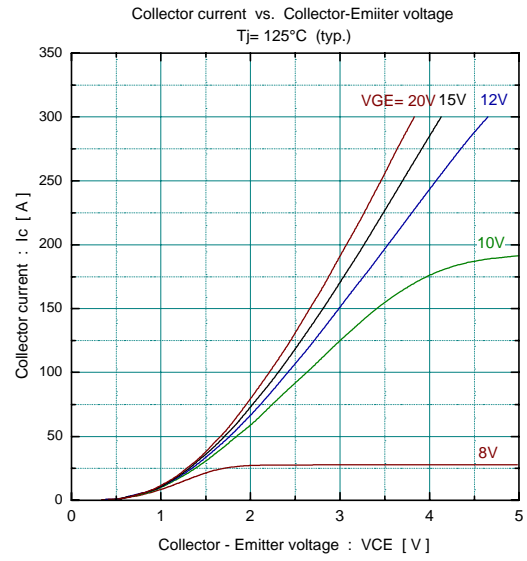
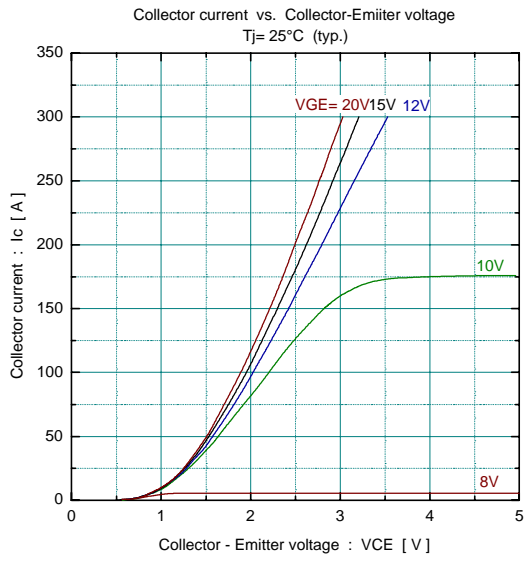

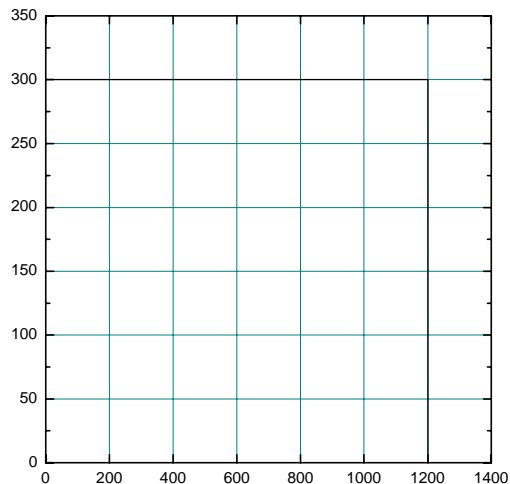
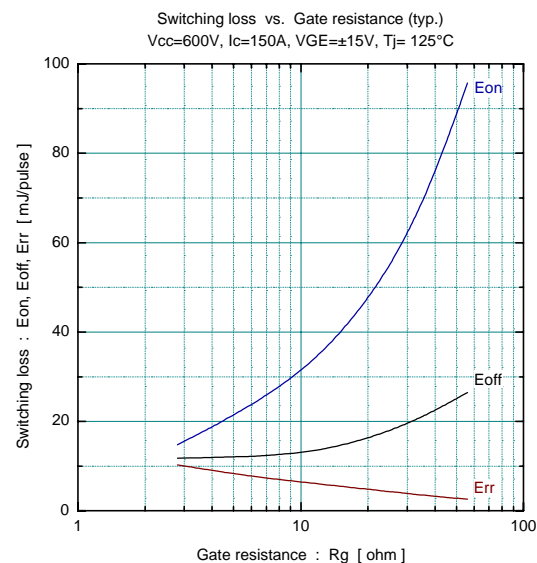
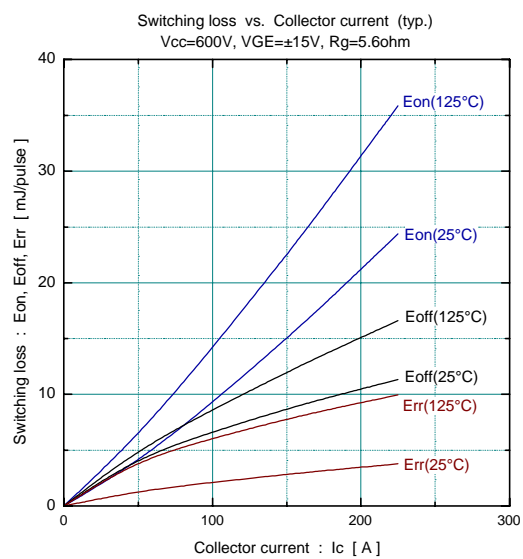
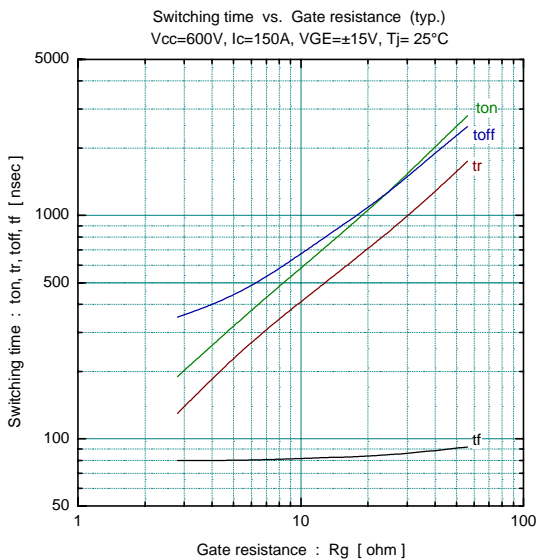
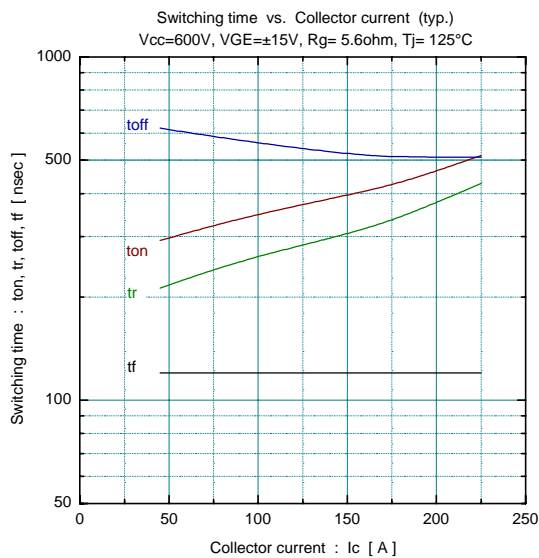
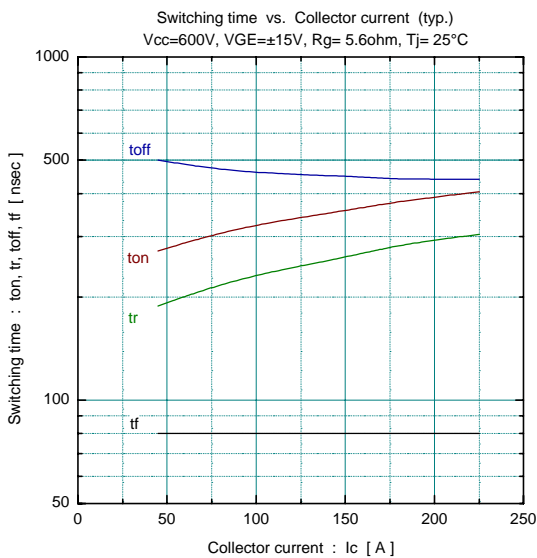

Forward current vs. Forward on voltage (typ.)

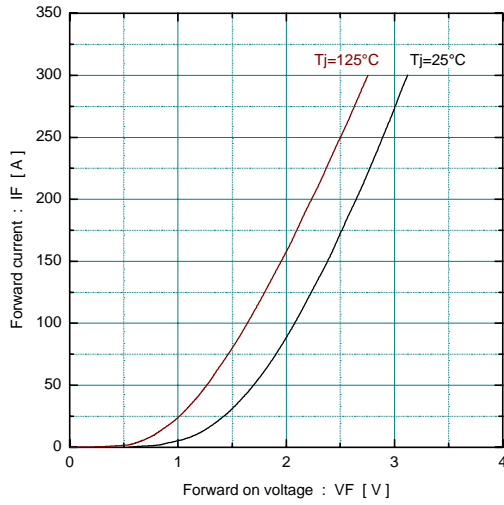

Reverse recovery characteristics (typ.)

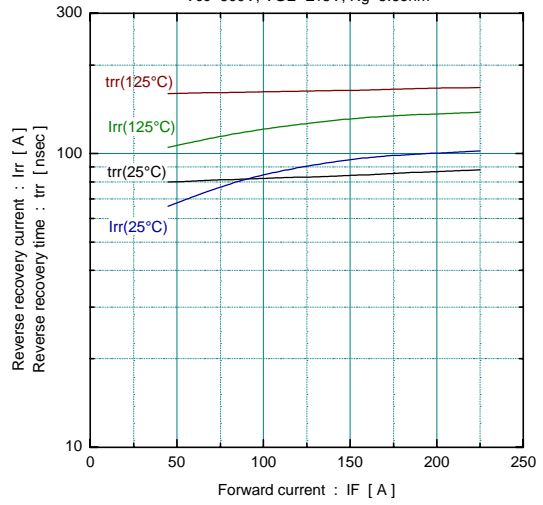

Transient thermal resistance

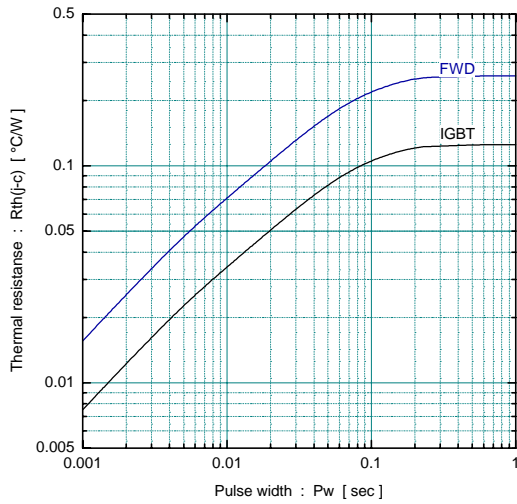

■ Outline Drawings, mm

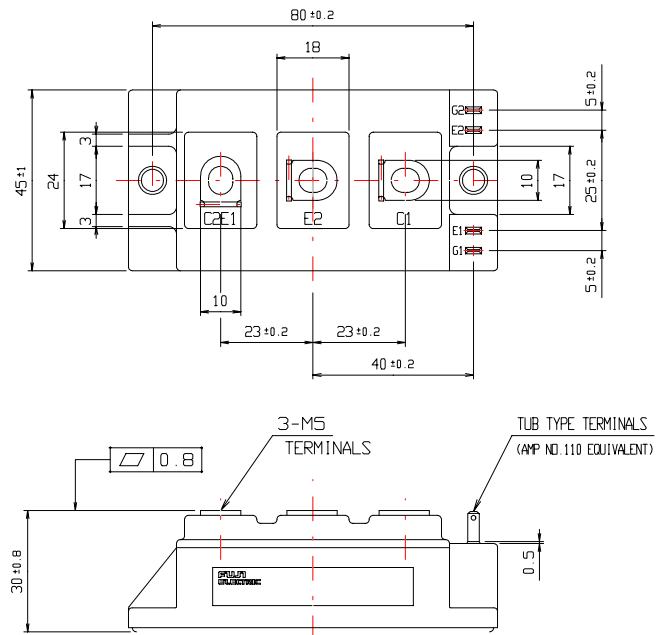

mass : 240g