

SLC100 1.8V

40 Amp Single Output Quarter Brick DC/DC Converter

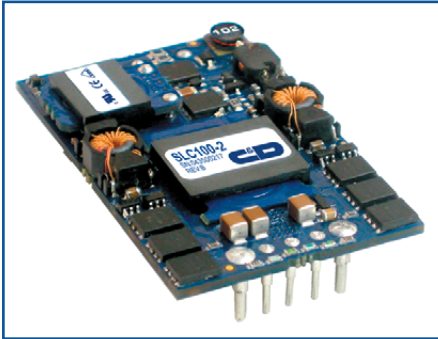

- Industry Standard Footprint & Size - 2.28" x 1.45"
- High Efficiency
- Wide Input Voltage Range: 36 – 75VDC
- Series Output Voltages: 1.0V, 1.2V, 1.5V, 1.8V, 2.0V, 2.5V, 3.3V, 5.0V & 12V
- Output Voltage Trim Function
- Remote Sense for output compensation
- Remote ON/OFF control referenced to input side (Positive or Negative Logic)
- Output Current Limit
- No Minimum Load Requirement
- SMD Models with Position Perfect™ Interconnects
- Isolation Voltage of 2000 VDC
- Fixed Frequency Operation
- UL/CUL 60950 recognized (US & Canada), VDE EN60950, basic insulation rating
- Meets TNV-SELV Isolation Requirements
- Meets Conducted Emissions Requirements of FCC Class B and EN55022 Class B with External Filter
- No Heatsink Required
- Thermal Shutdown
- Input Undervoltage Lockout



The SLC100 Series is a 40 Amp single output, low-profile DC-DC converter in an industry standard package of 2.28" x 1.45" x 0.40". The SLC100 uses unique proprietary technologies to deliver ultra-high efficiencies and excellent thermal performance. It includes extensive control and protection features for maximum flexibility and satisfies the power requirements for a whole range of

applications with its input voltage range of 36-75 VDC and output voltages between 1.0VDC and 12.0VDC

The power dissipation of the SLC100 series is so low that a heat sink is not required. Thermal derating curves are provided indicating maximum allowable output current versus airflow and ambient temperature. The product features fast dynamic response characteristics and

low output ripple critical for low voltage applications. SLC DC-DC converter modules are certified to UL/CUL 60950, and VDE EN60950. It meets CISPR22/EN55022/FCC15J Class B specs for EMI levels with external filtering.

This high quality and highly reliable product is competitively priced and an ideal solution for distributed power, telecoms and datacom applications.

PRODUCT SELECTION CHART

MODEL	NOMINAL INPUT VOLTAGE (Vdc)	RATED OUTPUT VOLTAGE (VDC)	OUTPUT CURRENT		INPUT CURRENT AT RATED LOAD (A) (48Vin)	EFFICIENCY TYPICAL (%)
			MIN LOAD(A)	RATED OUTPUT (A) ¹		
SLC100-4,13,22,31	48	1.8	0.0	40	1.90	84

* Note 1: Maximum output current for SMD Models is 25A.

ABSOLUTE MAXIMUM RATINGS, ALL MODELS

PARAMETER	CONDITIONS	MIN	TYP	MAX	UNITS
Input Voltage-Operating	Continuous			75	Vdc
Input Voltage-Operating	Transient (100 mS)			TBD	Vdc
Operating Ambient Temperature		-40		85	°C
Storage Temperature		-40		+125	°C
Output Short Circuit Duration			Continuous		
Lead Temperature (Soldering, 10 sec max)				+300	°C

COMMON ELECTRICAL SPECIFICATIONS, ALL MODELS

Specifications are at $T_A = +25^{\circ}\text{C}$, Airflow = 300LFM (1.5m/s) at nominal input voltage unless otherwise specified.

PARAMETER	CONDITIONS	MIN	TYP	MAX	UNITS
INPUT					
Voltage Range		36	48	75	VDC
ISOLATION					
Input/Output Isolation Voltage		2000			VDC
Capacitance	Input to Output		2000		pF
Resistance	Input to Output	10			MΩ
FEATURES					
Turn On Time	Output to within 1% of Vnom			5.00	mS
Remote Sense Compensation				5	% of V _{NOM}
Output Voltage Trim Range		-10		+10	% of V _{NOM}
Output Over Voltage Protection		+120		+140	% of V _{NOM}
Over Temperature Shutdown					
Shutdown			TBD		°C
Turn On			TBD		°C
Input Under Voltage Protection					
Turn Off		30.00		32.00	VDC
Turn On		32.00		34.00	VDC
Lockout Hysteresis Voltage		0		2.0	VDC
ON/OFF Logic Function					
Logic Low Ion/off				TBD	mA
Logic Low Von/off				TBD	VDC
Logic High Ion/off				TBD	μA
Logic High Von/off			Open Collector	TBD	VDC
GENERAL					
Switching Frequency			200		KHz
MTTF (per Telcordia TR-NWT-332)		1,497,000			Hrs

COMMON ELECTRICAL SPECIFICATIONS

MECHANICAL (THROUGH HOLE)

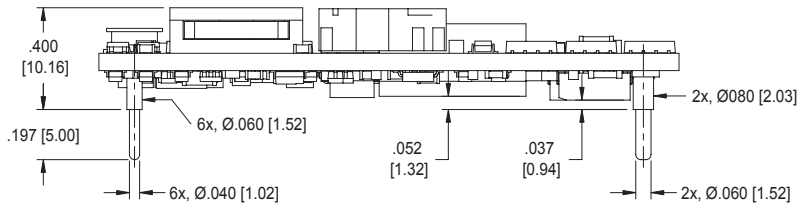

PIN FUNCTIONS	
1	+Vin
2	Remote On/Off
3	-Vin
4	-Vout
5	- Sense
6	Trim
7	+ Sense
8	+Vout

NOTES:

General Tolerance: ± 0.015
 Pin Locations/Diameters: ± 0.005
 Dimensions are in inches
 [Millimeters]
 Pin material: Copper
 Pin Finish: Matte Tin over Nickel
 Converter weight: [30.8g]

UL/TUV Standards require a clearance greater than 0.04" between input and output for Basic insulation. This should be considered if copper traces are used on the top side of the board under the converter unit. Ferrite cores are considered part of the input/primary circuit.

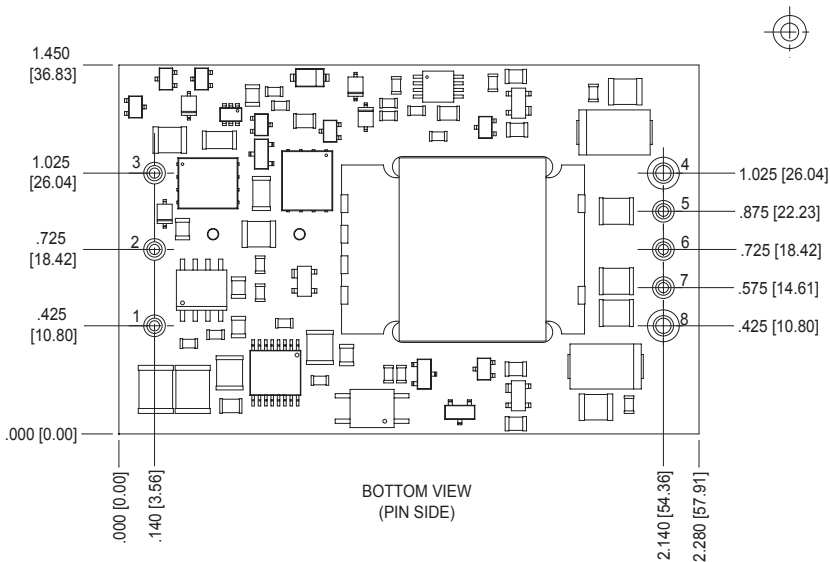

BOTTOM VIEW
(PIN SIDE)

MECHANICAL (SMT)



Interconnect FUNCTIONS	
1	+Vin
2	Remote On/Off
3	-Vin
4	-Vout
5	- Sense
6	Trim
7	+ Sense
8	+Vout

NOTES:

General Tolerance: ± 0.015
 Interconnect Locations/
 Diameters: ± 0.005
 Dimensions are in inches
 [Millimeters]
 Pin material: Copper
 Pin Finish: Matte Tin over Nickel
 Converter weight: [30.8g]

UL/TUV Standards require a clearance greater than 0.04" between input and output for Basic insulation. This should be considered if copper traces are used on the top side of the board under the converter unit. Ferrite cores are considered part of the input/primary circuit.

* Interconnect co-planarity within 0.004"

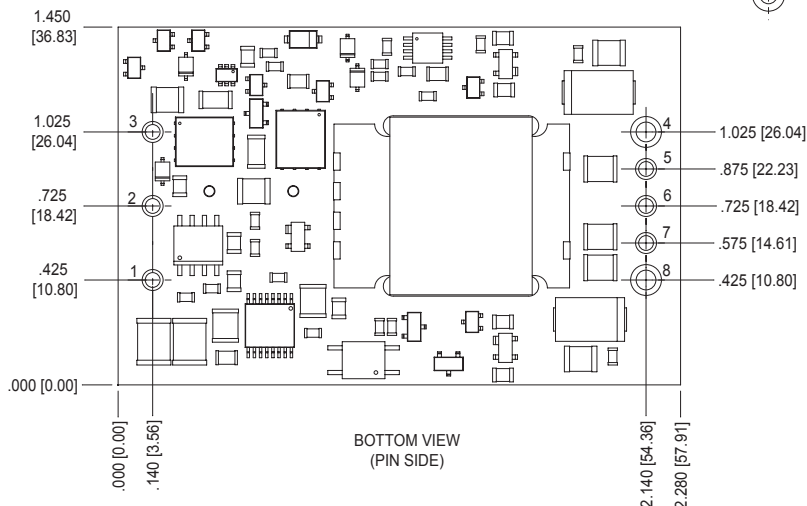

BOTTOM VIEW
(PIN SIDE)

ORDERING INFORMATION

MODEL NUMBER	Vout (Vdc)	PINOUT	LOGIC
SLC100 - 1	1.0	Through Hole	Positive
SLC100 - 2	1.2	Through Hole	Positive
SLC100 - 3	1.5	Through Hole	Positive
SLC100 - 4	1.8	Through Hole	Positive
SLC100 - 5	2.0	Through Hole	Positive
SLC100 - 6	2.5	Through Hole	Positive
SLC100 - 7	3.3	Through Hole	Positive
SLC100 - 8	5.0	Through Hole	Positive
SLC100 - 9	12.0	Through Hole	Positive
SLC100 - 10	1.0	SMD	Positive
SLC100 - 11	1.2	SMD	Positive
SLC100 - 12	1.5	SMD	Positive
SLC100 - 13	1.8	SMD	Positive
SLC100 - 14	2.0	SMD	Positive
SLC100 - 15	2.5	SMD	Positive
SLC100 - 16	3.3	SMD	Positive
SLC100 - 17	5.0	SMD	Positive
SLC100 - 18	12.0	SMD	Positive

MODEL NUMBER	Vout (Vdc)	PINOUT	LOGIC
SLC100 - 19	1.0	Through Hole	Negative
SLC100 - 20	1.2	Through Hole	Negative
SLC100 - 21	1.5	Through Hole	Negative
SLC100 - 22	1.8	Through Hole	Negative
SLC100 - 23	2.0	Through Hole	Negative
SLC100 - 24	2.5	Through Hole	Negative
SLC100 - 25	3.3	Through Hole	Negative
SLC100 - 26	5.0	Through Hole	Negative
SLC100 - 27	12.0	Through Hole	Negative
SLC100 - 28	1.0	SMD	Negative
SLC100 - 29	1.2	SMD	Negative
SLC100 - 30	1.5	SMD	Negative
SLC100 - 31	1.8	SMD	Negative
SLC100 - 32	2.0	SMD	Negative
SLC100 - 33	2.5	SMD	Negative
SLC100 - 34	3.3	SMD	Negative
SLC100 - 35	5.0	SMD	Negative
SLC100 - 36	12.0	SMD	Negative

Operation

Remote Sense

The remote sense feature of the SLC100 can be used to compensate for voltage drops in the output power lines by sensing output voltage directly at the point of load. To enable this feature, connect the +Sense and -Sense pins to the +Vout and -Vout pins, respectively, at the point in the circuit where the tightest regulation is required (Figure 1). The sense leads conduct very little current compared with the power leads and therefore provide a more accurate indication of load voltage for regulation purposes. This enables the converter to increase (or decrease) its output voltage to compensate for any load distribution losses, allowing for a more precise load voltage. Refer to the product data sheet for the maximum output voltage compensation range of the sense function.

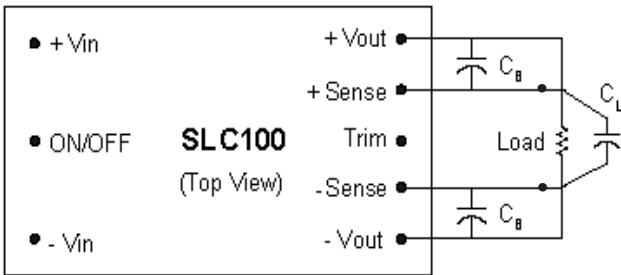

Figure 1 – Remote Sensing Circuit

In general, the line resistance, or load drop, between the output pins of the converter and load should be minimized. Using remote sense, a large line resistance, with a regulated load voltage, will result in a higher output voltage at the output of the DC/DC Converter. To prevent exceeding the converter’s output power limits, a higher output voltage will require a reduction in the maximum allowable output current in accordance with the voltage/current power relationship. To minimize the line resistance between the converter and the load, the converter should be placed as close to the load as possible. Line resistance can further be decreased by using heavy gauge wire or by increasing the cross sectional area of the PC board traces.

When using remote sense with dynamic loads, the transient response at the point of load may be limited by the inductance present in the power lines. Severe load steps may require the addition of a capacitor C_L across the output lines. When the load demands an immediate increase in load current, this capacitor helps to supply a portion of the current and reduces the burden on the converter.

When the load is physically distanced from the converter, the inductance of the power leads, and any bypass conductance at the load, can result in increased phase shift in the converter’s feedback loop, causing instability. This situation can be eliminated by inserting bypass capacitors (C_B) from the outputs to the sense leads directly at the output pins. These capacitors de-couple any AC on the power lines and assure that only the DC voltage is sensed.

If remote sensing is not desired then +Sense and -Sense must be tied to their respective outputs for proper operation.

Output Voltage Trim

The SLC100’s output voltage may be adjusted high or low by an amount indicated on the product data sheet. As shown in Figure 2, to raise the converter’s output voltage a resistor must be placed between the Trim pin and +Vout pin.

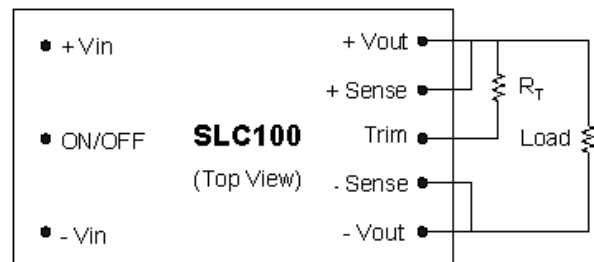

Figure 2 – Trim Up Circuit

To lower the converter output voltage a resistor must be placed between the Trim pin and -Vout pin as shown in **Figure 3**.

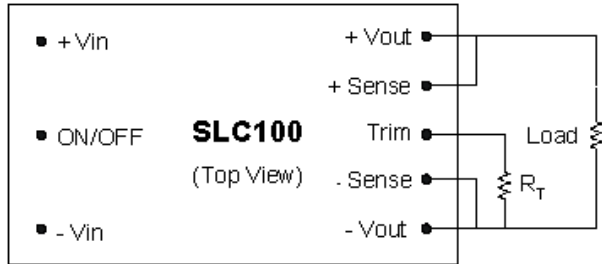

Figure 3 – Trim Down Circuit

The resistance value required to achieve the desired amount of positive/negative trim can be determined by referring to the trim table for each model. If trimming is not desired then the Trim pin may be left open. In addition to the resistor values provided in the trim tables, the following equations can be used to calculate the required resistor value for a desired output voltage. These equations apply for the 1.5V and above models. *For 1.2V models the trim tables must be used.*

$$R_{\text{trim_up}} = \left(\frac{5.11V_{\text{out}} (100 + \Delta\%) - 511 - 10.22}{\Delta\%} \right) \text{ k}\Omega$$

$$V_{\text{ref}} = 1.225$$

$$R_{\text{trim_down}} = \left[\frac{5.11}{\Delta\%} - 10.22 \right] \text{ k}\Omega$$

Remote ON/OFF Control Function

The SLC100 is equipped with a primary ON/OFF pin used to remotely turn the converter on or off via a system signal. The input is TTL open-collector and/or FET open-drain compatible. For the positive logic model a system logic low signal will turn the unit off. For negative logic models a system logic high signal will turn the converter off. For negative logic models where no control signal will be used the ON/OFF pin should be connected directly to -Vin to ensure proper operation. For positive logic models where no control signal will be used the ON/OFF pin should be left open.

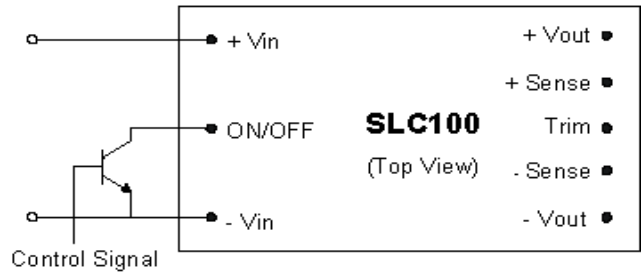

Figure 4 – Remote ON/OFF Control Circuit

Protective Functions

Temperature Shutdown

The over temperature shutdown feature of the SLC100 will cause the unit to shutdown at a typical pwb temperature of TBD. This protective feature is comprised of a thermistor in the units control loop. At a temperature of TBD this circuit will cause the PWM to go into an idle mode, resulting in no output from the converter and preventing damage to the converter components. When the temperature of the unit drops below TBD the fault condition will clear and the converter will resume normal operation. If the cause of the over temperature condition is not identified and corrected the unit will continue to cycle on and off indefinitely.

Input Under-Voltage Shutdown

The nominal input voltage for the SLC100 is 48Vdc. Once turned on reducing the input voltage to 32.0 Vdc nominal will shut down the device. At an input voltage less than 32.0V the under-voltage sensing circuit will send a signal to the PWM causing it to go into idle mode. This will result in no output from the converter, protecting the unit from a high input current condition. When the input voltage returns to a level above 32.0V the unit will return to normal operation. The unit will typically turn on at an input voltage of between 32.0V and 34.0V nominal as indicated on the Product Data Sheet. This is due to hysteresis designed into the protective circuit to prevent excessive cycling of the converter.

Brick Wall Current Limiting

To protect against fault or short-circuit conditions on the output, each module is equipped with current-limiting circuitry designed to provide continuous protection. After reaching the current limit point (typically 20% above the rated output current), the voltage will range between its rated value and zero, depending upon the amount of overload. The unit will remain in operation continuously during this period down to a short-circuit condition. Once the short or overload has been eliminated, the output voltage will return to normal without cycling the input power.

Output Over-Voltage Protection

The SLC100 has an output over voltage protection (OVP) circuit which monitors its own output voltage. If the output voltage of the converter exceeds between 120% and 140% of the nominal rating, the OVP circuit will shut down the converter. Once the OVP has been tripped the unit will need to be reset by cycling the input power or by toggling the ON/OFF power before normal operation can resume.

SLC100 units with a non-latching OVP feature are available on request. Please contact the factory for further details.

Safety

The SLC100 meets safety requirements per UL/CUL 60950 and VDE EN60950, basic insulation rating.

EMC/EMI Considerations

Analysis pending.

Performance Characterization

Thermal Derating

Maximum output current vs. ambient temperature at various airflow rates has been determined for each model of the SLC100. Each model was analyzed over an ambient temperature range of 0 to 85°C and at air flows up to 700LFM. Temperature limits for thermal derating curves were TBD C for semiconductor junction temperature and TBD C for board temperature.

Start-Up, ON/OFF and Transient Response

For each model, waveforms are provided showing output voltage response and timing of input voltage power up/down, remote ON/OFF state change and load current transient responses. Output voltage transient responses are provided for step load changes of 50% to 75% & 75% to 50% of rated load current. Waveforms for each model are provided in their respective section.

Efficiency Performance

Efficiency data for each model was determined as a function of both load current and input voltage. Efficiency vs. Input Voltage was measured at full load, ambient temperature of 25°C and airflow of 300LFM. Efficiency vs. Load Current was measured at 25°C, a nominal input voltage of 48Vdc and airflow of 300LFM. Graphs are provided for each model in their respective section.

SLC100 1.8VOUT ELECTRICAL SPECIFICATIONS

Specifications are at $T_A = +25^\circ\text{C}$, Airflow = 300LFM (1.5m/s) at nominal input voltage unless otherwise specified.

PARAMETER		CONDITIONS	MIN	TYP	MAX	UNITS
ELECTRICAL SPECIFICATIONS	INPUT					
	Maximum Input Current	Full Load; $V_{in} = 36\text{Vdc}$			2.40	A
	Inrush Charge	$V_{in} = 75\text{Vdc}$			0.180	mC
	Reflected Ripple Current	Full Load, XXMHz Bandwidth			TBD	Apk-pk
	Input Voltage Ripple Rejection	Full Load (100Hz-1KHz)	-30			dB
	No Load Input Current	No Load			85	mA
	Disabled Input Current				2.0	mA
	Recommended Input Fuse	Fast blow external fuse			7	A
	OUTPUT					
	Voltage Setpoint		1.773	1.8	1.827	Vdc
	Voltage Range	Over all conditions of line, load and temperature	TBD		TBD	Vdc
	Line Regulation			0.05	0.10	% of V_{nom}
	Load Regulation			0.25	0.50	% of V_{nom}
	Output Ripple			100	180	mVpk-pk
	Output Current Range		0		40 ¹	A
	Output Current Limit Inception		42		46	A
	Efficiency			84		%
	Transient Response	50% to 75% Load Step at $di/dt = 0.1\text{ A}/\mu\text{S}$; $C_{ext} = \text{None}$				
Peak Deviation				160	mV	
Settling Time				320	μS	
External Load Capacitance				50,000	μF	
Rated Power				72	W	

* Note 1: Maximum output current for SMD Models is 25A.

TRIM RESISTANCE VALUES FOR 1.8V MODULE

Trim Up		Trim Down	
Trim (%)	Rtrim (Kohm)	Trim (%)	Rtrim (Kohm)
1	237.15	1	500.78
2	117.22	2	245.28
3	57.25	3	160.11
4	57.25	4	117.53
5	45.26	5	91.98
6	37.26	6	74.95
7	31.55	7	62.78
8	27.27	8	53.66
9	23.94	9	46.56
10	21.27	10	40.88

PERFORMANCE CURVES: SLC100 (1.8 VOUT)

Efficiency vs. Output Current
@ $T_A = +25^\circ\text{C}$; $V_{in} = 48\text{Vdc}$



Efficiency vs. Input Voltage
@ $T_A = +25^\circ\text{C}$; $I_o = 40\text{A}$



Turn On Time (V_{in} to V_{out})

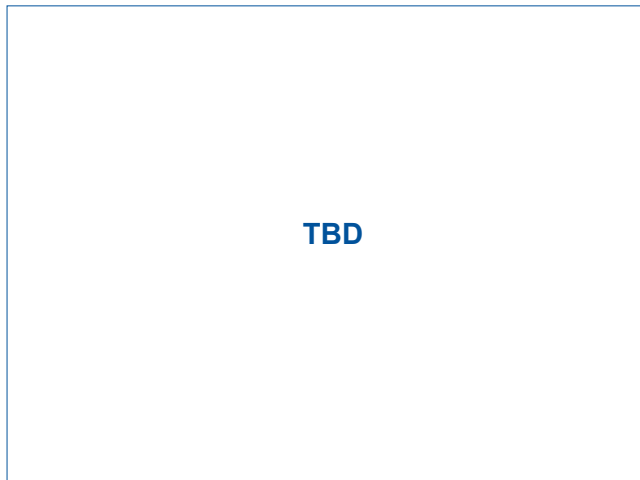

Turn Off Time (V_{in} to V_{out})

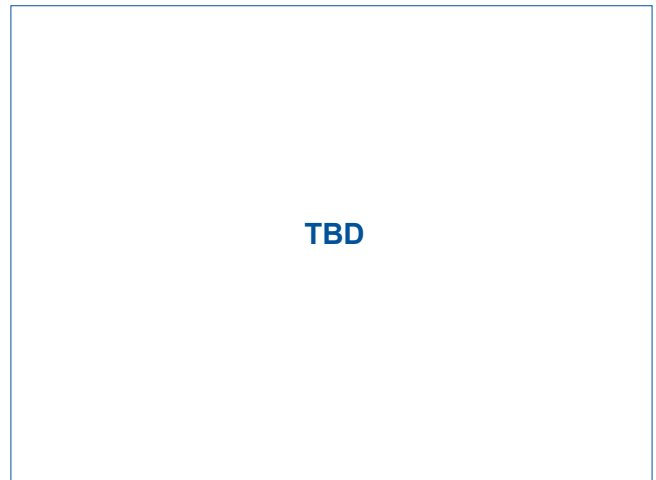

Primary On Time (Primary Remote to V_{out})



Primary Off Time (Primary Remote to V_{out})

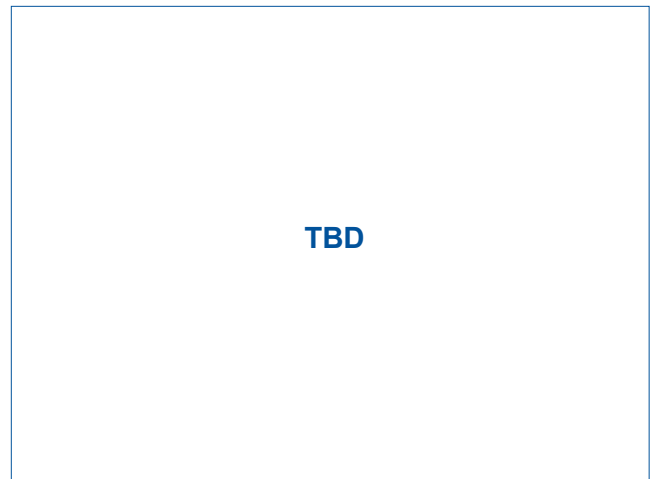

PERFORMANCE CURVES: SLC100 (1.8 VOUT) continued

Transient Response, 50% to 75% Load Step

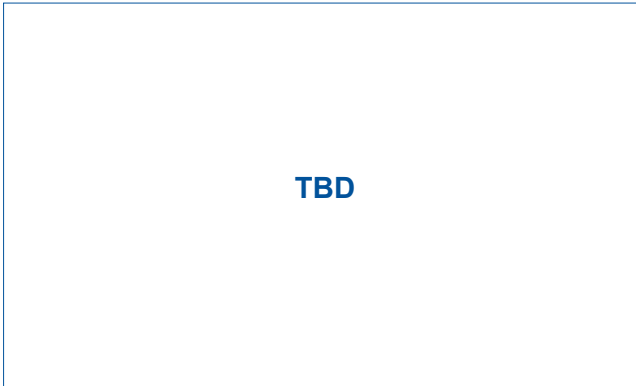

Transient Response, 75% to 50% Load Step

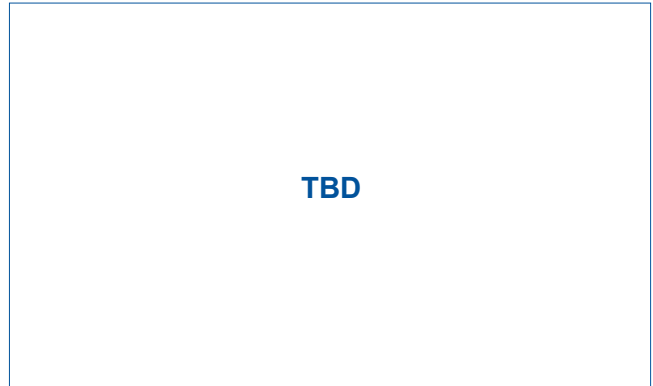

For additional technical support or ordering information please visit our website at www.CDpoweronline.com or call your local representative.

Power Electronics Division, Americas
3400 E Britannia Drive, Tucson, Arizona 85706
Tel: 800.547.2537
Fax: 520.295.4197

C&D Technologies, EMEA/Asia/Pacific
Milton Keynes MK14 5BU UK
Tel: +44 (0)1908 615232
Fax: +44 (0)1908 617545

Any data, prices, descriptions or specifications presented herein are subject to revision by C&D Technologies, Inc. without notice. While such information is believed to be accurate as indicated herein, C&D Technologies, Inc. makes no warranty and hereby disclaims all warranties, express or implied, with regard to the accuracy or completeness of such information. Further, because the product(s) featured herein may be used under conditions beyond its control, C&D Technologies, Inc. hereby disclaims all warranties, either express or implied, concerning the fitness or suitability of such product(s) for any particular use or in any specific application or arising from any course of dealing or usage of trade. The user is solely responsible for determining the suitability of the product(s) featured herein for user's intended purpose and in user's specific application. C&D Technologies, Inc. does not warrant or recommend that any of its products be used in any life support or aviation or aerospace applications.