

PLEASE CHECK WWW.MOLEX.COM FOR LATEST PART INFORMATION

Part Number: [0901362303](#)
Status: **Active**
Overview: [cgrid_iii](#)
Description: 2.54mm (.100") Pitch C-Grid III™ Header, Single Row, Right Angle, Shrouded, 3 Circuits, 0.76µm (30µ") Gold (Au) Selective Plating

Documents:

[3D Model](#) [RoHS Certificate of Compliance \(PDF\)](#)
[Drawing \(PDF\)](#)

General

| | |
|----------------|---------------------------|
| Product Family | PCB Headers |
| Series | 90136 |
| Application | Wire-to-Board |
| Overview | cgrid_iii |
| Product Name | C-Grid III™ |

Physical

| | |
|--------------------------------|-----------------|
| Breakaway | No |
| Circuits (Loaded) | 3 |
| Circuits (maximum) | 3 |
| Color - Resin | Black |
| First Mate / Last Break | No |
| Glow-Wire Compliant | No |
| Guide to Mating Part | No |
| Keying to Mating Part | None |
| Lock to Mating Part | Yes |
| Material - Metal | Brass |
| Material - Plating Mating | Gold |
| Material - Plating Termination | Tin |
| Material - Resin | Polyester |
| Number of Rows | 1 |
| Orientation | Right Angle |
| PC Tail Length (in) | 0.114 In |
| PC Tail Length (mm) | 2.90 mm |
| PCB Locator | No |
| PCB Retention | None |
| PCB Thickness Recommended (in) | 0.062 In |
| PCB Thickness Recommended (mm) | 1.60 mm |
| Packaging Type | Tray |
| Pitch - Mating Interface (in) | 0.100 In |
| Pitch - Mating Interface (mm) | 2.54 mm |
| Plating min: Mating (µin) | 30.48 |
| Plating min: Mating (µm) | 0.762 |
| Plating min: Termination (µin) | 120 |
| Plating min: Termination (µm) | 3 |
| Polarized to PCB | No |
| Shrouded | Fully |
| Stackable | No |
| Temperature Range - Operating | -55°C to +125°C |
| Termination Interface: Style | Through Hole |

Electrical

| | |
|-------------------------------|------|
| Current - Maximum per Contact | 3A |
| Voltage - Maximum | 350V |



EU RoHS

ELV and RoHS Compliant
REACH SVHC Contains SVHC: No
Halogen-Free Status

China RoHS



Not Reviewed

Need more information on product environmental compliance?

Email productcompliance@molex.com
 For a multiple part number RoHS Certificate of Compliance, [click here](#)

Please visit the [Contact Us](#) section for any non-product compliance questions.

Search Parts in this Series

[90136Series](#)

Mates With

[90123 C-Grid III™ Modular Crimp Housing.](#)
[90156 C-Grid III™ Crimp Housing](#)

Solder Process Data

Lead-free Process Capability

Wave Capable (TH only)

Material Info**Reference - Drawing Numbers**

Packaging Specification

PK-90136-001

Sales Drawing

SDA-90136

This document was generated on 05/26/2010

PLEASE CHECK WWW.MOLEX.COM FOR LATEST PART INFORMATION



1 TO 3 CIRCUITS

4 TO 32 CIRCUITS



SECTION K-K

| No. OF CKTS | DIM A | DIM B | DIM C |
|-------------|-------------------|-------------------|-------------------|
| 1 | | (5.89) / .232 | (4.06) / .160 |
| 2 | (2.54) / .100 | (8.43) / .332 | (6.60) / .260 |
| 3 | (5.08) / .200 | (10.97) / .432 | (9.14) / .360 |
| 4 | (7.62) / .300 | (13.51) / .532 | (11.68) / .460 |
| 5 | (10.16) / .400 | (16.05) / .632 | (14.22) / .560 |
| 6 | (12.70) / .500 | (18.59) / .732 | (16.76) / .660 |
| 7 | (15.24) / .600 | (21.13) / .832 | (19.30) / .760 |
| 8 | (17.78) / .700 | (23.67) / .932 | (21.84) / .860 |
| 9 | (20.32) / .800 | (26.21) / 1.032 | (24.38) / .960 |
| 10 | (22.86) / .900 | (28.75) / 1.132 | (26.92) / 1.060 |
| 11 | (25.4) / 1.000 | (31.29) / 1.232 | (29.46) / 1.160 |
| 12 | (27.94) / 1.100 | (33.83) / 1.332 | (32.00) / 1.260 |
| 13 | (30.48) / 1.200 | (36.37) / 1.432 | (34.54) / 1.360 |
| 14 | (33.02) / 1.300 | (38.91) / 1.532 | (37.08) / 1.460 |
| 15 | (35.56) / 1.400 | (41.45) / 1.632 | (39.62) / 1.560 |
| 16 | (38.10) / 1.500 | (43.99) / 1.732 | (42.16) / 1.660 |
| 17 | (40.64) / 1.600 | (46.53) / 1.832 | (44.70) / 1.760 |
| 18 | (43.18) / 1.700 | (49.07) / 1.932 | (47.24) / 1.860 |
| 19 | (45.72) / 1.800 | (51.61) / 2.032 | (49.78) / 1.960 |
| 20 | (48.26) / 1.900 | (54.15) / 2.132 | (52.32) / 2.060 |
| 21 | (50.80) / 2.000 | (56.69) / 2.232 | (54.86) / 2.160 |
| 22 | (53.34) / 2.100 | (59.23) / 2.332 | (57.40) / 2.260 |
| 23 | (55.88) / 2.200 | (61.77) / 2.432 | (59.94) / 2.360 |
| 24 | (58.42) / 2.300 | (64.31) / 2.532 | (62.48) / 2.460 |
| 25 | (60.96) / 2.400 | (66.85) / 2.632 | (65.02) / 2.560 |
| 26 | (63.50) / 2.500 | (69.39) / 2.732 | (67.56) / 2.660 |
| 27 | (66.04) / 2.600 | (71.93) / 2.832 | (70.10) / 2.760 |
| 28 | (68.58) / 2.700 | (74.47) / 2.932 | (72.64) / 2.860 |
| 29 | (71.12) / 2.800 | (77.01) / 3.032 | (75.18) / 2.960 |
| 30 | (73.66) / 2.900 | (79.55) / 3.132 | (77.72) / 3.060 |
| 31 | (76.20) / 3.000 | (82.09) / 3.232 | (80.26) / 3.160 |
| 32 | (78.74) / 3.100 | (84.63) / 3.332 | (82.80) / 3.260 |

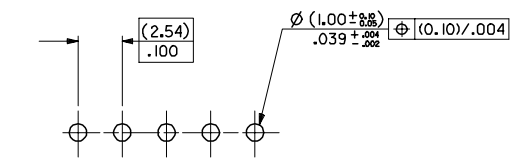

RECOMMENDED P.C. BOARD HOLE PATTERN

- NOTES
- MATERIAL:-
 - PIN:- (0.635) / .025 SQ.BRASS WIRE.
 - HOUSING:- 15% GLASS FILLED POLYESTER
 - UL 94 V-0 COLOUR BLACK
 - FOR PLATING VERSIONS SEE SHEET 2.
 - MEASUREMENT POINT FOR MINIMUM PLATING THICKNESS
 - PRODUCT SPEC: PS-99020-0001
 - RECOMMENDED PCB THICKNESS 1.6mm

| REV | DESCRIPTION | QUALITY SYMBOLS | GENERAL TOLERANCES (UNLESS SPECIFIED) | | DIMENSION STYLE | | SCALE | DESIGN UNITS | THIRD ANGLE PROJECTION | |
|--------|---------------------|-----------------|---|--------|-----------------|--------------|-------|--------------|--|--|
| | | | mm | INCH | MM/IN | DATE | TITLE | METRIC | | |
| ADDED | CIRCUIT 1 INDICATOR | ▽=0 | 4 PLACES | ± --- | ± --- | DRAWN BY | 5:1 | METRIC | C-GRID III SINGLE ROW STRAIGHT SHROUDED HEADER | |
| EC NO: | E2008-0112 | ▽=0 | 3 PLACES | ± --- | ± .004 | DATE | | | MOLEX INCORPORATED | |
| DRW: | NBB/BNES | | 2 PLACES | ± 0.10 | ± --- | 1987/10/30 | | | MOLEX INCORPORATED | |
| CHKD: | 2007/09/10 | | 1 PLACE | ± --- | ± --- | CHECKED BY | | | SDA-90136 | |
| APPR: | JMALLACE | | ANGULAR ±1/2° | | | DATE | | | 1 OF 100 | |
| | | | DRAFT WHERE APPLICABLE MUST REMAIN WITHIN DIMENSIONS | | | APPROVED BY | | | | |
| | | | SEE CHART | | | DATE | | | | |
| | | | THIS DRAWING CONTAINS INFORMATION THAT IS PROPRIETARY TO MOLEX INCORPORATED AND SHOULD NOT BE USED WITHOUT WRITTEN PERMISSION | | | MATERIAL NO. | | | | |
| | | | | | | DOCUMENT NO. | | | | |

13 12 11 10 9 8 7 6 5 4 3 2 1

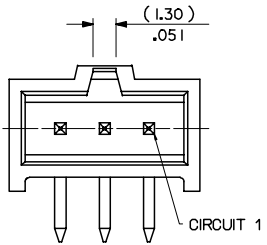

1 TO 3 CIRCUITS

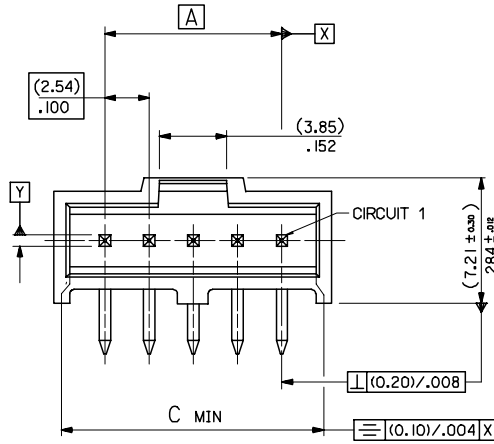

4 TO 32 CIRCUITS

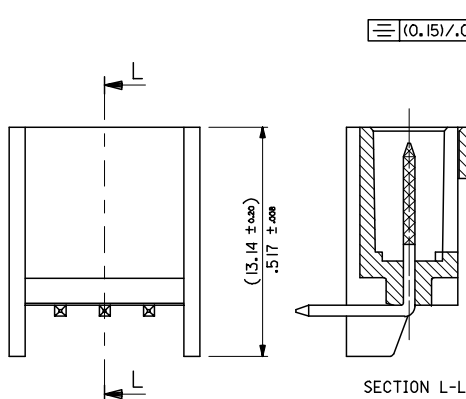

1 TO 6 CIRCUITS

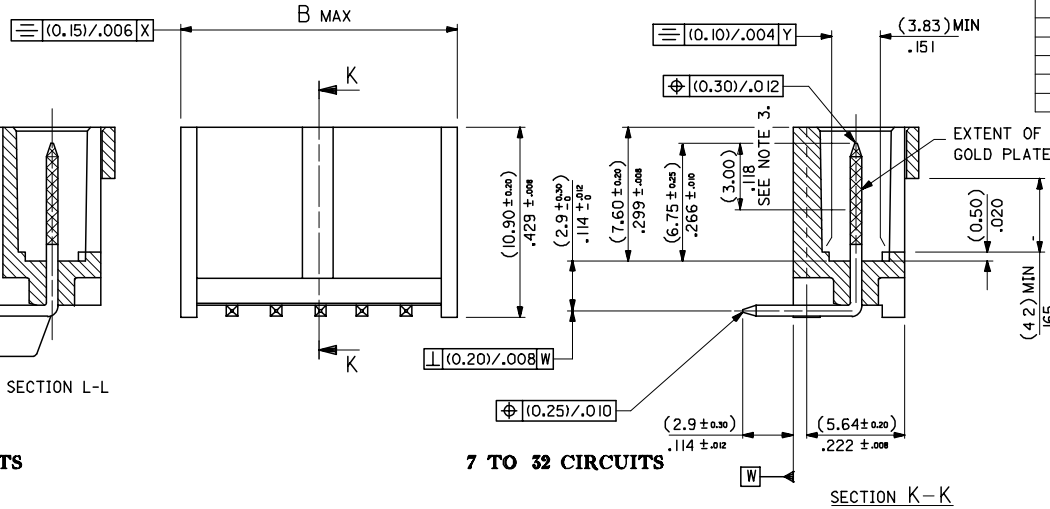

7 TO 32 CIRCUITS

SECTION K-K

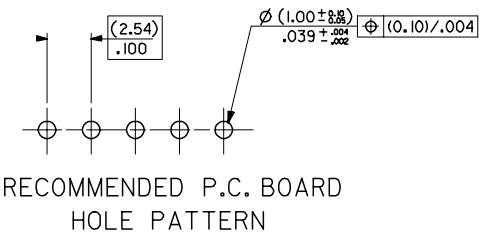

RECOMMENDED P.C. BOARD HOLE PATTERN

| No. OF CKTS | DIM A | DIM B | DIM C |
|-------------|-------------------|-------------------|-------------------|
| 1 | | (5.89) / .232 | (4.06) / .160 |
| 2 | (2.54) / .100 | (8.43) / .332 | (6.60) / .260 |
| 3 | (5.08) / .200 | (10.97) / .432 | (9.14) / .360 |
| 4 | (7.62) / .300 | (13.51) / .532 | (11.68) / .460 |
| 5 | (10.16) / .400 | (16.05) / .632 | (14.22) / .560 |
| 6 | (12.70) / .500 | (18.59) / .732 | (16.76) / .660 |
| 7 | (15.24) / .600 | (21.13) / .832 | (19.30) / .760 |
| 8 | (17.78) / .700 | (23.67) / .932 | (21.84) / .860 |
| 9 | (20.32) / .800 | (26.21) / 1.032 | (24.38) / .960 |
| 10 | (22.86) / .900 | (28.75) / 1.132 | (26.92) / 1.060 |
| 11 | (25.40) / 1.000 | (31.29) / 1.232 | (29.46) / 1.160 |
| 12 | (27.94) / 1.100 | (33.83) / 1.332 | (32.00) / 1.260 |
| 13 | (30.48) / 1.200 | (36.37) / 1.432 | (34.54) / 1.360 |
| 14 | (33.02) / 1.300 | (38.91) / 1.532 | (37.08) / 1.460 |
| 15 | (35.56) / 1.400 | (41.45) / 1.632 | (39.62) / 1.560 |
| 16 | (38.10) / 1.500 | (43.99) / 1.732 | (42.16) / 1.660 |
| 17 | (40.64) / 1.600 | (46.53) / 1.832 | (44.70) / 1.760 |
| 18 | (43.18) / 1.700 | (49.07) / 1.932 | (47.24) / 1.860 |
| 19 | (45.72) / 1.800 | (51.61) / 2.032 | (49.78) / 1.960 |
| 20 | (48.26) / 1.900 | (54.15) / 2.132 | (52.32) / 2.060 |
| 21 | (50.80) / 2.000 | (56.69) / 2.232 | (54.86) / 2.160 |
| 22 | (53.34) / 2.100 | (59.23) / 2.332 | (57.40) / 2.260 |
| 23 | (55.88) / 2.200 | (61.77) / 2.432 | (59.94) / 2.360 |
| 24 | (58.42) / 2.300 | (64.31) / 2.532 | (62.48) / 2.460 |
| 25 | (60.96) / 2.400 | (66.85) / 2.632 | (65.02) / 2.560 |
| 26 | (63.50) / 2.500 | (69.39) / 2.732 | (67.56) / 2.660 |
| 27 | (66.04) / 2.600 | (71.93) / 2.832 | (70.10) / 2.760 |
| 28 | (68.58) / 2.700 | (74.47) / 2.932 | (72.64) / 2.860 |
| 29 | (71.12) / 2.800 | (77.01) / 3.032 | (75.18) / 2.960 |
| 30 | (73.66) / 2.900 | (79.55) / 3.132 | (77.72) / 3.060 |
| 31 | (76.20) / 3.000 | (82.09) / 3.232 | (80.26) / 3.160 |
| 32 | (78.74) / 3.100 | (84.63) / 3.332 | (82.80) / 3.260 |

NOTES

- MATERIAL:-
 - PIN*- (0.635) / .025 SQ. BRASS WIRE.
 - HOUSING*- 15% GLASS FILLED POLYESTER
 - UL 94 V-0 COLOUR BLACK
2. FOR PLATING VERSIONS SEE SHEET 4.
 3. MEASUREMENT FOR MINIMUM PLATING THICKNESS
 4. PRODUCT SPEC: PS-99020-0001
 5. RECOMMENDED PCB THICKNESS 1.6mm

| | | | | | | |
|--|--|---|--------------------------|--------------------|--|------------------------|
| CIRCUIT 1 IDENTIFIED EC NO: E2008-0112 DRAWN: BIRNIES 2007/09/10 CHKD: 2007/09/10 APPR: WALLACE 2007/09/11 | QUALITY SYMBOLS ▽=0 ▽=0 | GENERAL TOLERANCES (UNLESS SPECIFIED) | DIMENSION STYLE MM/IN | SCALE 5:1 | DESIGN UNITS METRIC | THIRD ANGLE PROJECTION |
| | DESCRIPTION | 4 PLACES ± --- ± --- 3 PLACES ± --- ± .004 2 PLACES ± 0.10 ± --- 1 PLACE ± --- ± --- ANGULAR ± 1/2° | DRAWN BY KS | DATE 1987/09/29 | TITLE C-GRID 111 SINGLE ROW RIGHT ANGLE SHROUDED HEADER | |
| REV | DRAFT WHERE APPLICABLE MUST REMAIN WITHIN DIMENSIONS | SEE CHART | APPROVED BY | DATE | MOLEX MOLEX INCORPORATED | SHEET NO. 3 OF 100 |
| | | | MATERIAL NO. | DOCUMENT NO. | SDA-90136 | |

12 11 10 9 8 7 6 5 4 3 2 1

F

E

D

C

B

A

F

E

D

C

B

A

| NO. OF CKTS | PART NUMBERS | | |
|-------------|----------------|----------------|----------------|
| | PLATING TYPE A | PLATING TYPE E | PLATING TYPE F |
| 1 | 90136-2101 | 90136-2201 | 90136-2301 |
| 2 | ▲ -2102 | ▲ -2202 | ▲ -2302 |
| 3 | -2103 | -2203 | -2303 |
| 4 | -2104 | -2204 | -2304 |
| 5 | -2105 | -2205 | -2305 |
| 6 | -2106 | -2206 | -2306 |
| 7 | -2107 | -2207 | -2307 |
| 8 | -2108 | -2208 | -2308 |
| 9 | -2109 | -2209 | -2309 |
| 10 | -2110 | -2210 | -2310 |
| 11 | -2111 | -2211 | -2311 |
| 12 | -2112 | -2212 | -2312 |
| 13 | -2113 | -2213 | -2313 |
| 14 | -2114 | -2214 | -2314 |
| 15 | -2115 | -2215 | -2315 |
| 16 | -2116 | -2216 | -2316 |
| 17 | -2117 | -2217 | -2317 |
| 18 | -2118 | -2218 | -2318 |
| 19 | -2119 | -2219 | -2319 |
| 20 | -2120 | -2220 | -2320 |
| 21 | -2121 | -2221 | -2321 |
| 22 | -2122 | -2222 | -2322 |
| 23 | -2123 | -2223 | -2323 |
| 24 | -2124 | -2224 | -2324 |
| 25 | -2125 | -2225 | -2325 |
| 26 | -2126 | -2226 | -2326 |
| 27 | -2127 | -2227 | -2327 |
| 28 | -2128 | -2228 | -2328 |
| 29 | -2129 | -2229 | -2329 |
| 30 | -2130 | -2230 | -2330 |
| 31 | ▼ -2131 | ▼ -2231 | ▼ -2331 |
| 32 | 90136-2132 | 90136-2232 | 90136-2332 |

NOTES
 1.FOR ASSY SEE SHEET 3
 2.FOR PLATING DETAILS SEE SDES 99000-0003

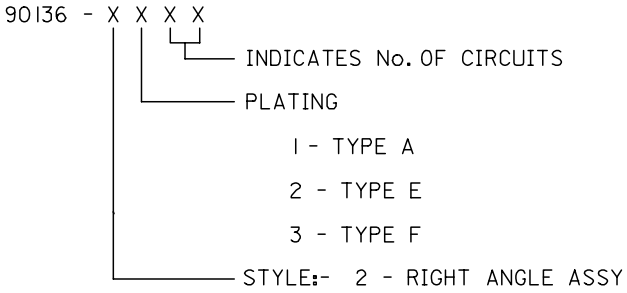

| UPDATED TABLE EC NO: E2007-1001 DRWN:DBYRNES CHKD: APPR:EDMAHONY 2007/06/07 2007/06/07 2007/06/07 | QUALITY SYMBOLS ▽=0 ◻=0 | GENERAL TOLERANCES (UNLESS SPECIFIED) <table border="1"> <tr><th colspan="2">mm</th><th colspan="2">INCH</th></tr> <tr><td>4 PLACES</td><td>±---</td><td>±---</td><td>±---</td></tr> <tr><td>3 PLACES</td><td>±---</td><td>±---</td><td>±---</td></tr> <tr><td>2 PLACES</td><td>±---</td><td>±---</td><td>±---</td></tr> <tr><td>1 PLACE</td><td>±---</td><td>±---</td><td>±---</td></tr> <tr><td colspan="2">ANGULAR</td><td colspan="2">±---°</td></tr> </table> | mm | | INCH | | 4 PLACES | ±--- | ±--- | ±--- | 3 PLACES | ±--- | ±--- | ±--- | 2 PLACES | ±--- | ±--- | ±--- | 1 PLACE | ±--- | ±--- | ±--- | ANGULAR | | ±---° | | DIMENSION STYLE MM ONLY DRAWN BY: KS DATE: 1987/09/28 CHECKED BY: RD DATE: 1991/10/16 APPROVED BY: NW DATE: 1991/10/17 | SCALE: --- DESIGN UNITS: METRIC THIRD ANGLE PROJECTION | TITLE: C-GRID SHRD HDR SR VT MOLEX INCORPORATED DOCUMENT NO. SDA-90136 SHEET NO. 4 OF 8 |
|--|-------------------------------|---|------|------|------|--|----------|------|------|------|----------|------|------|------|----------|------|------|------|---------|------|------|------|---------|--|-------|--|---|--|--|
| | mm | | INCH | | | | | | | | | | | | | | | | | | | | | | | | | | |
| | 4 PLACES | ±--- | ±--- | ±--- | | | | | | | | | | | | | | | | | | | | | | | | | |
| | 3 PLACES | ±--- | ±--- | ±--- | | | | | | | | | | | | | | | | | | | | | | | | | |
| 2 PLACES | ±--- | ±--- | ±--- | | | | | | | | | | | | | | | | | | | | | | | | | | |
| 1 PLACE | ±--- | ±--- | ±--- | | | | | | | | | | | | | | | | | | | | | | | | | | |
| ANGULAR | | ±---° | | | | | | | | | | | | | | | | | | | | | | | | | | | |
| DRAFT WHERE APPLICABLE MUST REMAIN WITHIN DIMENSIONS | SEE CHART | THIS DRAWING CONTAINS INFORMATION THAT IS PROPRIETARY TO MOLEX INCORPORATED AND SHOULD NOT BE USED WITHOUT WRITTEN PERMISSION | | | | | | | | | | | | | | | | | | | | | | | | | | | |