

PLEASE CHECK WWW.MOLEX.COM FOR LATEST PART INFORMATION

Part Number: [0758322104](#)
Status: **Active**
Overview: [gbx_backplane_connector_system](#)
Description: 1.85mm by 1.85mm (.073" by .073") Pitch 2-Pair GbX® Backplane Connector System, Right Guide Header, 40 Circuits, Pin Length 4.55mm (.179"), Lead Free

Documents:

[Drawing \(PDF\)](#) [RoHS Certificate of Compliance \(PDF\)](#)
[Product Specification PS-75221-999 \(PDF\)](#)

Agency Certification

UL E29179

General

Product Family Backplane Connectors
 Series [75832](#)
 Application Backplane
 Application Tooling Documents [Tooling Manual](http://www.molex.com/pdm_docs/ats/TM-622022099.pdf)
 Component Type PCB Header
 Overview [gbx_backplane_connector_system](#)
 Product Name GbX®
 Style N/A

Physical

Circuits (Loaded) 40
 Circuits (maximum) 40
 Color - Resin Gray
 Durability (mating cycles max) 200
 First Mate / Last Break No
 Flammability 94V-0
 Guide to Mating Part Yes
 Keying to Mating Part None
 Material - Metal High Performance Alloy (HPA), Stainless Steel
 Material - Plating Mating Gold
 Material - Plating Termination Tin
 Material - Resin High Temperature Thermoplastic
 Number of Columns 10
 Number of Pairs 2
 Number of Rows 4
 Orientation Vertical
 PC Tail Length (in) 0.091 In
 PC Tail Length (mm) 2.30 mm
 PCB Locator No
 PCB Retention Yes
 PCB Thickness Recommended (in) 0.063 In
 PCB Thickness Recommended (mm) 1.60 mm
 Packaging Type Tube
 Pitch - Mating Interface (in) 0.073 In
 Pitch - Mating Interface (mm) 1.85 mm
 Pitch - Term. Interface (in) 0.073 In
 Pitch - Term. Interface (mm) 1.85 mm
 Plating min: Mating (µin) 30
 Plating min: Mating (µm) 0.76
 Plating min: Termination (µin) 30
 Plating min: Termination (µm) 0.76

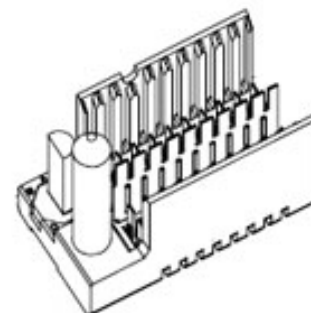

image - Reference only

Series

EU RoHS

ELV and RoHS Compliant
REACH SVHC
 Not Reviewed
Halogen-Free Status
Not Reviewed

China RoHS



Need more information on product environmental compliance?

Email productcompliance@molex.com
 For a multiple part number RoHS Certificate of Compliance, [click here](#)

Please visit the [Contact Us](#) section for any non-product compliance questions.

Search Parts in this Series

[75832Series](#)

Mates With

[75874 GbX® Daughtercard Lead-Free](#)

Application Tooling | FAQ

Tooling specifications and manuals are found by selecting the products below. Crimp Height Specifications are then contained in the Application Tooling Specification document.

Global

Description	Product #
GbX® 2 Pair by 10 Wide Differential Insertion Tool	0622022410

Polarized to PCB	No
Stackable	No
Surface Mount Compatible (SMC)	Yes
Temperature Range - Operating	105°C
Termination Interface: Style	Through Hole - Compliant Pin

Electrical

Current - Maximum per Contact	1A
Data Rate	8.0 Gbps
Shielded	No
Voltage - Maximum	120V AC (RMS)/DC

Material Info

Reference - Drawing Numbers

Packaging Specification	PK-70873-5058
Product Specification	PS-75221-999
Sales Drawing	SD-75832-210

GbX is a registered trademark of Amphenol Corporation.

This document was generated on 05/14/2010

PLEASE CHECK WWW.MOLEX.COM FOR LATEST PART INFORMATION

20 19 18 17 16 15 14 13 12 11 75832 9 8 7 6 5 4 3 2 1

L
K
J
I
H
G
F
E
D
C
B
A

L
K
J
I
H
G
F
E
D
C
B
A

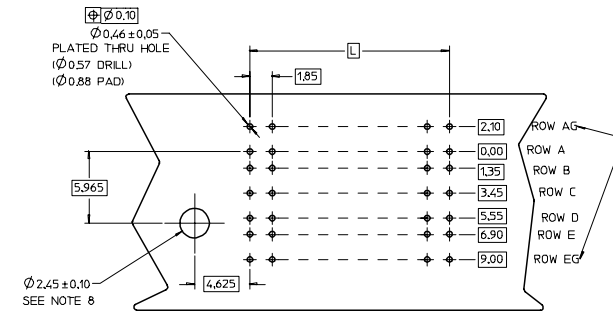
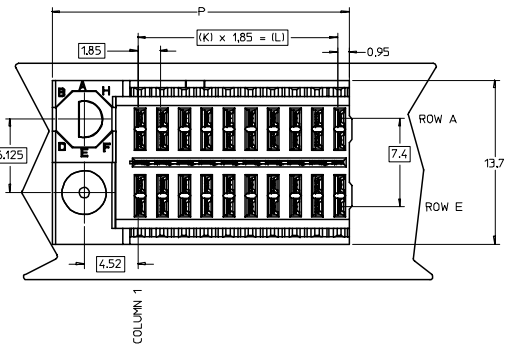

ROW AG & EG RECOMMENDED FOR ALL APPLICATIONS. THESE ROWS SHOULD BE CONNECTED TO GROUND.

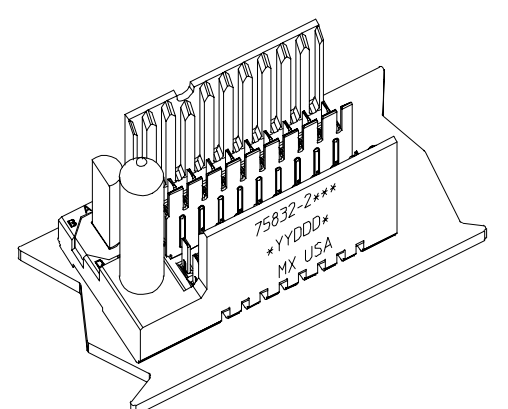

BACKPLANE HOLE PATTERN (COMPONENT SIDE-10 POS SHOWN)

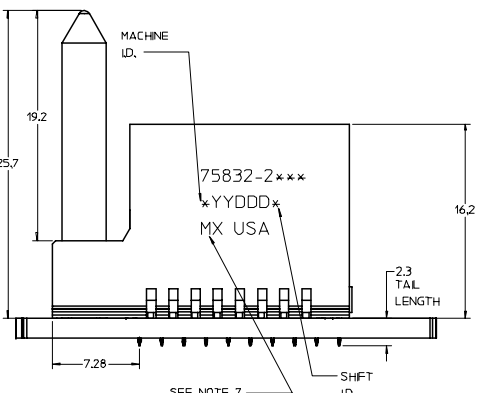

SEE NOTE 7

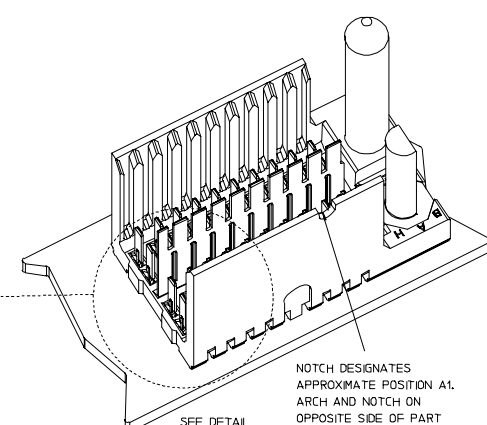
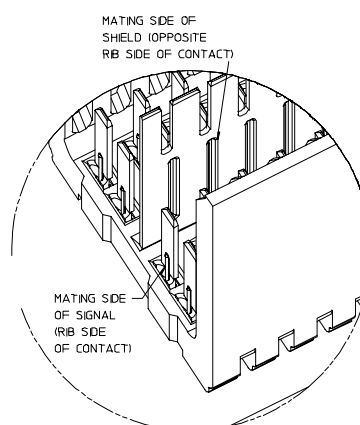
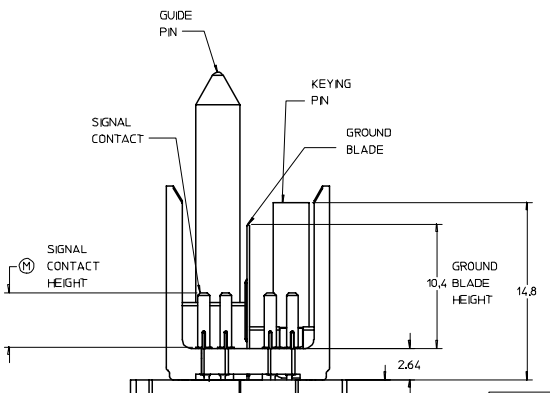

PART NUMBER TABLE				
ASSY PART NO.	K	L	P	TOTAL NO. OF DIFFERENTIAL PAIRS
75832-21**	9	16.65	24.78	20
75832-22**	24	44.40	52.53	50

- NOTES:
- MATERIAL: HOUSING - LIQUID CRYSTAL POLYMER (LCP) GLASS-FILLED. UL 94V-0. COLOR - gray. SIGNAL CONTACT AND GROUND BLADE - HIGH PERFORMANCE COPPER ALLOY.
 - FINISHES: SELECTIVE GOLD (Au) ON CONTACT AREA. SELECTIVE MATTE TIN (Sn) ON PCB TAILS. NICKEL (Ni) OVERALL.
 - THIS PART CONFORMS TO MOLEX PRODUCT SPECIFICATION PS-75221-999.
 - FOR MIXED CONTACT MATING LENGTHS CONSULT MOLEX FOR AVAILABILITY. CONTACT PAIRS MUST BE THE SAME LENGTH.
 - FOR SPECIFIC PART NUMBER AND MATING INFORMATION PLEASE REFER TO CHART.
 - PACKAGE PER PK-70873-5058.
 - EITHER MARK PART NUMBER AND DATE CODE APPROXIMATELY WHERE SHOWN OR PLACE A LABEL ON THE TUBE.
 - OPTIONAL HOLE LOCATION FOR GROUNDED GUIDE PIN OR ADDITIONAL GUIDE PIN SUPPORT. FOR GROUNDED GUIDE, HOLE TO BE PLATED, DRILL SIZE $\phi 2.58$, PAD SIZE $\phi 5.50$.
 - THESE PARTS CONFORM TO MOLEX COSMETIC SPECIFICATION PS-45499-002 CLASS B.

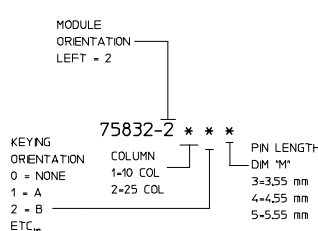

P/N	---0*	---1*	---2*	---3*	---4*	---5*	---6*	---7*	---8*
75832-1)	0	A	B	C	D	E	F	G	H

LEAD-FREE PLATING ON SIGNALS, & GROUNDS.

EC NO: UCP 2007-2580 DRWN: JBINGHAM 2007/05/02 CHKD: 2007/05/02 APPR: SPEED 2007/05/02 DESCRIPTION	QUALITY SYMBOLS	GENERAL TOLERANCES (UNLESS SPECIFIED)	SCALE 5:1	DESIGN UNITS METRIC	THIRD ANGLE PROJECTION	REVISE ON CAD ONLY
	4 PLACES ±--- 3 PLACES ±--- 2 PLACES ±--- 1 PLACE ±--- ANGULAR ±---°	mm INCH DIMENSION STYLE MM ONLY	DRAWN BY DATE CTHOMA 2005/01/13 CHECKED BY DATE KMULVEY 2006/01/16 APPROVED BY DATE JBINGHAM 2006/01/17	TITLE GBX 2-PAIR LEFT END BACKPLANE ASSEMBLY LEAD-FREE SALES DRAWING	MATERIAL NO. SEE CHART	DOCUMENT NO. SD-75832-210
DRAFT WHERE APPLICABLE MUST REMAIN WITHIN DIMENSIONS		THIS DRAWING CONTAINS INFORMATION THAT IS PROPRIETARY TO MOLEX INCORPORATED AND SHOULD NOT BE USED WITHOUT WRITTEN PERMISSION				

Rev. 01 2000/08/01 19 18 17 16 15 14 13 12 11 10 9 8 7 6 5 4 3 2 1