

Descriptions

- General purpose application
- Switching application

Features

- Low Leakage current
- Low collector saturation voltage enabling low voltage operation
- Complementary pair with MMBT2907A

Ordering Information

Type NO.	Marking	Package Code
MMBT2222A	$\frac{1P}{\text{① ②}}$	SOT-23

①Device Code ②Year& Week Code

PIN Connection

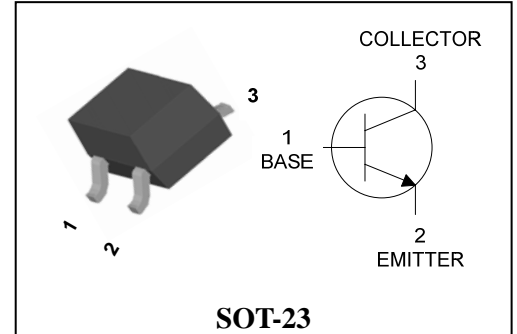

Absolute maximum ratings

T_a=25°C

Characteristic	Symbol	Ratings	Unit
Collector-Base voltage	V _{CBO}	75	V
Collector-Emitter voltage	V _{CEO}	40	V
Emitter-base voltage	V _{EBO}	5	V
Collector current	I _C	0.6	A(DC)
	I _{CP} [*]	1.2	A(Pulse)
Collector dissipation	P _C ^{**}	350	mW
Junction temperature	T _J	150	°C
Storage temperature range	T _{stg}	-55~150	°C

* : Single pulse, t_p= 300 μs

** : Package mounted on 99.5% alumina 10×8×0.6mm

Electrical Characteristics

Ta=25°C

Characteristic	Symbol	Test Condition	Min.	Typ.	Max.	Unit
Collector-Base breakdown voltage	BV_{CBO}	$I_C=10\mu A, I_E=0$	75	-	-	V
Collector-Emitter breakdown voltage	BV_{CEO}	$I_C=1mA, I_B=0$	40	-	-	V
Emitter-Base breakdown voltage	BV_{EBO}	$I_E=10\mu A, I_C=0$	5	-	-	V
Collector cut-off current	I_{CBO}	$V_{CB}=75V, I_E=0$	-	-	20	nA
DC current gain	h_{FE}	$V_{CE}=10V, I_C=10mA$	100	-	-	-
Collector-Emitter saturation voltage	$V_{CE(sat)}$	$I_C=150mA, I_B=15mA$	-	-	0.4	V
Transition frequency	f_T	$V_{CE}=20V, I_C=20mA,$ $f=100MHz$	250	-	-	MHz
Collector output capacitance	C_{ob}	$V_{CB}=10V, I_E=0, f=1MHz$	-	-	8	pF
Delay time	t_d	$V_{CC}=30V_{dc}, V_{BE(off)}=0.5V_{dc},$ $I_C=150mA_{dc}, I_{B1}=15mA_{dc}$	-	-	10	ns
Rise time	t_r		-	-	25	ns
Storage time	t_s	$V_{CC}=30V_{dc}, I_C=150mA_{dc},$ $I_{B1}=I_{B2}=15mA_{dc}$	-	-	225	ns
Fall Time	t_f		-	-	60	ns

Electrical Characteristic Curves

Fig. 1 $P_C - T_a$

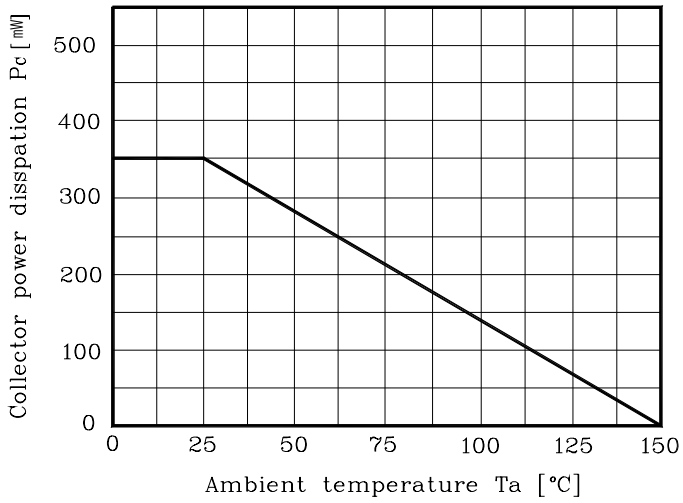

Fig. 2 $h_{FE} - I_C$

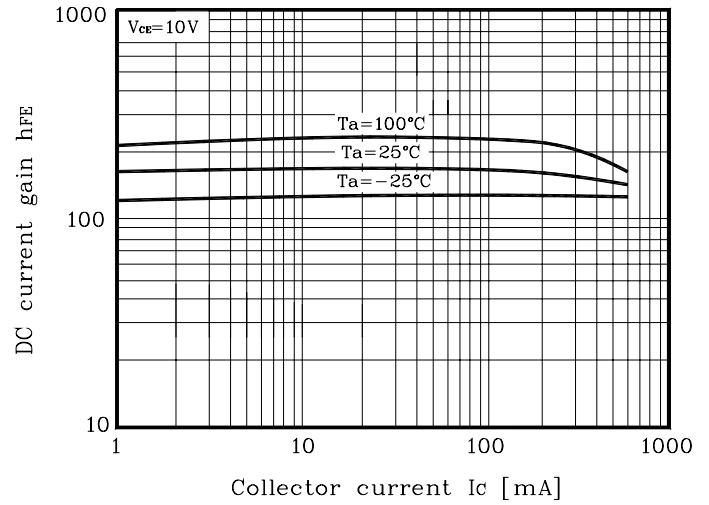

Fig. 3 $I_C - V_{CE(SAT)}$

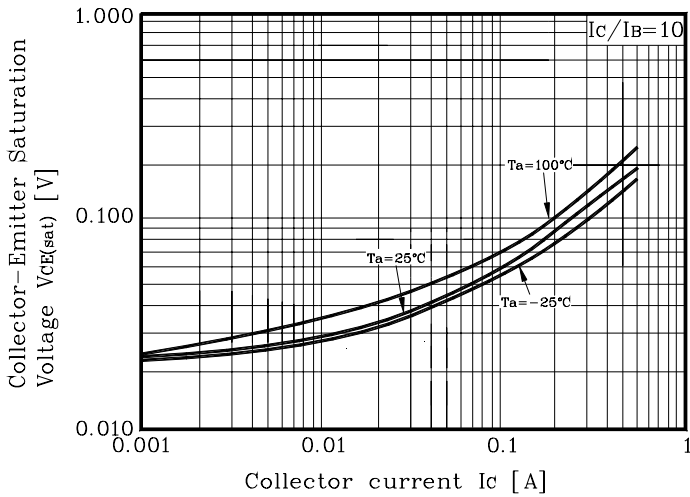

Fig. 4 $I_C - V_{BE(SAT)}$

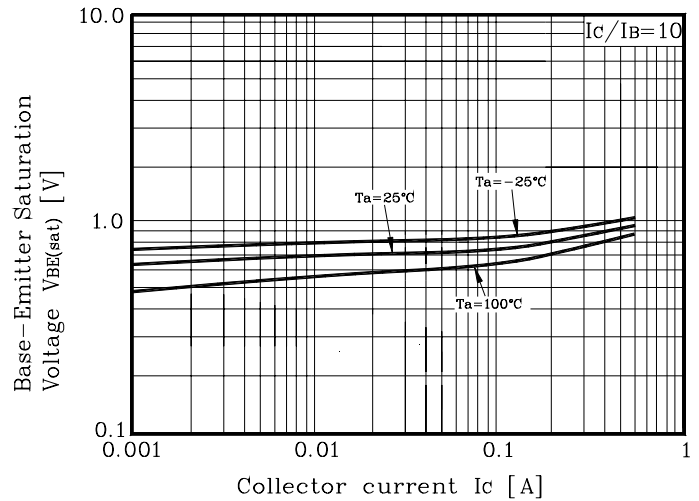
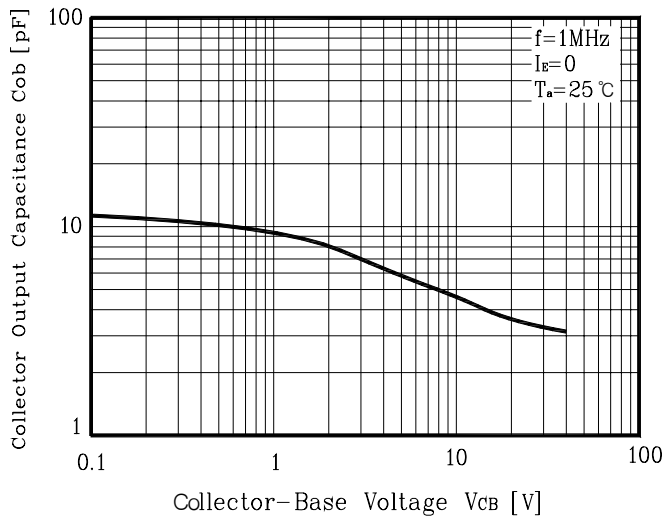
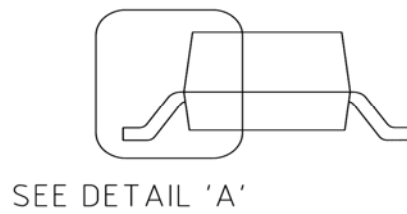
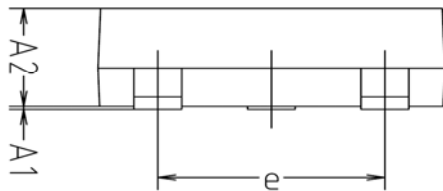
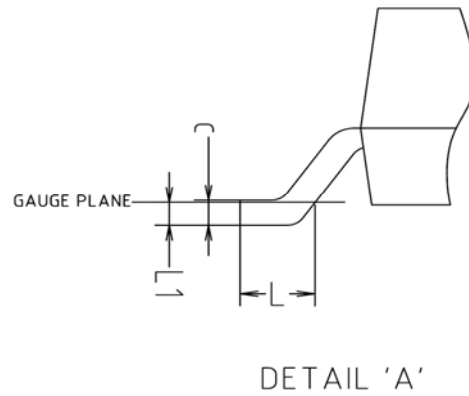
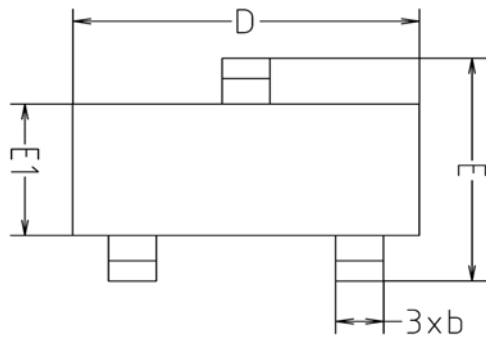

Fig. 5 $C_{ob} - V_{CB}$



Outline Dimension



SYMBOL	MILLIMETERS			NOTE
	MINIMUM	NOMINAL	MAXIMUM	
A1	0.00	-	0.10	
A2	0.82	-	1.02	
b	0.39	0.42	0.45	
c	0.09	0.12	0.15	
D	2.80	2.90	3.00	
E	2.20	2.40	2.60	
E1	1.20	1.30	1.40	
e	1.90BSC			
L	0.20	-	-	
L1	0.12BSC			

※Recommend PCB solder land [Unit: mm]

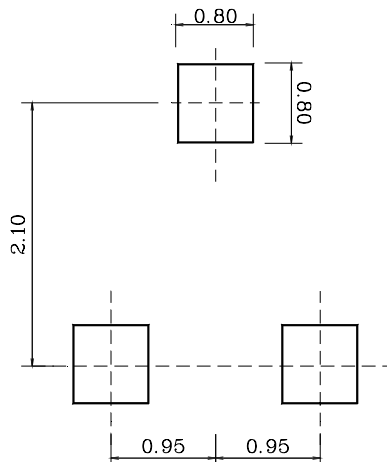

The AUK Corp. products are intended for the use as components in general electronic equipment (Office and communication equipment, measuring equipment, home appliance, etc.).

Please make sure that you consult with us before you use these AUK Corp. products in equipments which require high quality and / or reliability, and in equipments which could have major impact to the welfare of human life(atomic energy control, airplane, spaceship, transportation, combustion control, all types of safety device, etc.). AUK Corp. cannot accept liability to any damage which may occur in case these AUK Corp. products were used in the mentioned equipments without prior consultation with AUK Corp..

Specifications mentioned in this publication are subject to change without notice.