

ADVANCED ANALOG HIGH RELIABILITY RADIATION HARDENED DC/DC CONVERTER

G-SERIES

70V Input, Triple Output



Description

The G-Series of DC/DC converters are radiation hardened, high reliability converters designed for extended operation in hostile environments. Their small size and low weight make them ideal for applications such as geostationary earth orbit satellites and deep space probes. They exhibit a high tolerance to total ionizing dose, single event effects and environmental stresses such as temperature extremes, mechanical shock, and vibration. All components are fully derated to meet the requirements of MIL-STD-975, MIL-STD-1547 and GSFC PPL-21 Appendix B. Extensive documentation including Radiation Susceptibility, Thermal, Stress, Worst Case, Failure Modes and Effects analyses and MTBF are available for customer review and included with each order.

The converters incorporate a fixed frequency single ended forward topology with magnetic feedback and an internal EMI filter that utilizes multilayer ceramic capacitors that are subjected to extensive lot screening for optimum reliability. By using two stage filtering these converters produce low input and output noise. External inhibit and synchronization input and output allow these converters to be easily incorporated into larger power systems. They are enclosed in a hermetic 3" x 2" x 0.4" package constructed of an Aluminum/Silicon-Carbide (Al/SiC) base and an Alloy 48 ring frame and they weigh less than 90 grams. The package utilizes rugged ceramic feed-through copper core pins and is sealed using parallel seam welding.

Full environmental screening includes temperature cycling, constant acceleration, fine and gross leak, particle impact noise detection (PIND), radiographic and 320 hours burn-in.

Non-flight versions of the G-Series converters are available for system development purposes. Variations in electrical specifications and screening to meet custom requirements can be accommodated.

www.irf.com

Features

- Total Dose > 200 KRad(Si), typically usable to > 300 KRad(Si)
- SEE 82 MeV.cm²/mg
- Low Input & Output Noise
- Low Weight, < 90 grams
- Magnetically Coupled Feedback
- 60V to 120V DC Input Range
- Up to 40W Output Power
- Triple Output Models Include +5V and ±12V or ±15V
- Main Output Isolated from Dual Outputs
- High Efficiency - to 82%
- -55°C to +125°C Operating Temperature Range
- 100MΩ @ 500VDC Isolation
- Under-Voltage Lockout
- Synchronization Input and Output
- Short Circuit and Overload Protection
- Output Over Voltage Limiter
- External Inhibit
- > 5,000,000 Hour MTBF

Applications

- Geostationary Earth Orbit Satellites (GEO)
- Deep Space Satellites / Probes
- Strategic Weapons and Communication Systems

Circuit Description

The G-Series converters utilize a single-ended forward topology with resonant reset. The nominal switching frequency is 500kHz. Electrical isolation and tight output regulation are achieved through the use of a magnetically coupled feedback. Voltage feed-forward with duty factor limiting provides high line rejection and protection against output over voltage in the event of an internal control loop failure. This mechanism limits the maximum output voltage to approximately 20% over the nominal regardless of the line voltage.

An internal EMI filter reduces the conducted emissions to less than 5mA rms on the input power leads. A two-stage output filter reduces the typical output ripple to less than 20mV peak-to-peak.

The main (+5 volt) output is regulated by the control loop and typically exhibits better than 1% regulation. The auxiliary (±12 volt or ±15 volt) outputs are maintained through tight coupling in the power transformer and main output filter inductor and typically exhibit better than 5% regulation. The main output and auxiliary outputs are isolated from each other.

Output power is limited under any load fault condition to approximately 125% of rated. An overload condition causes the converter output to behave like a constant current source with the output voltage dropping below nominal. The converter will resume normal operation when the load current is reduced below the current limit point. This protects the converter from both overload and short circuit conditions. The current limit point exhibits a slightly negative temperature coefficient to reduce the possibility of thermal runaway.

An under-voltage lockout circuit prohibits the converter from operating when the line voltage is too low to maintain the output voltage. The converter will not start until the line voltage rises to approximately 58 volts and will shut down when the input voltage drops 54 volts. The four volt of hysteresis reduces

the possibility of line noise interfering with the converter's start-up and shut down.

An external inhibit port is provided to control converter operation. The nominal threshold relative to the input return (pin 2) is 1.4V. If 2.0 volts or greater are applied to the Inhibit pin (pin 3) then the converter will operate normally. A voltage of 0.8V or less will cause the converter to shut-down. The pin may be left open for normal operation and has a nominal open circuit voltage of 4.0V.

Synchronization input and output allow multiple converters to operate at a common switching frequency. Converters can be synchronized to one another or to an externally provided clock. This can be used to eliminate beat frequency noise or to avoid creating noise at certain frequencies for sensitive systems.

Design Methodology

The G-Series was developed using a proven conservative design methodology which includes selecting radiation tolerant and established reliability components and fully derating to the requirements of MIL-STD-975 and MIL-STD-1547. Careful sizing of decoupling capacitors and current limiting resistors minimizes the possibility of photo-current burn-out. Heavy derating of the radiation hardened power MOSFET virtually eliminates the possibility of SEGR and SEB. A magnetic feedback circuit is utilized instead of opto-couplers to minimize temperature, radiation and aging sensitivity. PSPICE and RadSPICE were used extensively to predict and optimize circuit performance for both beginning and end-of-life. Thorough design analyses include Radiation Susceptibility (TREE), Worst Case, Stress, Thermal, Failure Modes and Effects (FMEA) and Reliability (MTBF).

Absolute Maximum Ratings

Input voltage range - -0.5Vdc to +150Vdc
 Output power - Internally limited
 Lead temperature - +300°C for 10 seconds
 Operating temperature - -55°C to +135°C
 Storage temperature - -55°C to +135°C

Recommended Operating Conditions

Input voltage range - 60Vdc to +120Vdc
 Input voltage range¹ - 60Vdc to +100Vdc
 Output power - 0 to Max. Rated
 Operating temperature² - -55°C to +125°C
 Operating temperature¹ - -55°C to +70°C

¹ Meets derating per MIL-STD-975

² For operation at +125°C see table note 15

Electrical Performance Characteristics

Parameter	Group A Subgroup	Conditions -55°C ≤ T _C ≤ +85°C V _{IN} = 70V DC ± 5%, C _L = 0 unless otherwise specified	Limits			Unit
			Min	Nom	Max	
Input Voltage	1,2,3	Note 2	60	70	100	V
Output Voltage (V _{OUT}) (main) 700512T (aux.) 700515T (aux.)	1	I _{OUT} = 100% rated load, Note 5	4.98 ±11.50 ±14.60	5.00 ±11.80 ±14.90	5.02 ±12.10 ±15.20	V V V
(main) 700512T (aux.) 700515T (aux.)	2,3		4.93 ±11.30 ±14.40		5.07 ±12.30 ±15.40	V V V
Output power (P _{OUT})	1,2,3	V _{IN} = 60, 70, 100 Volts, Note 2	0		40	W
Output current (I _{OUT}) (main) 700512T (aux.) 700515T (aux.)	1,2,3	V _{IN} = 60, 70, 100 Volts, Notes 2,3,4,5	400 83 67		4000 ±833 ±667	mA mA mA
Line regulation (V _{RLINE}) (main) 700512T (aux.) 700515T (aux.)	1,2,3	V _{IN} = 60, 70, 100 Volts I _{OUT} = 10%, 50%, 100% rated Note 5, 14	-10 -120 -150		10 120 150	mV mV mV
Load regulation (V _{RLOAD}) (main) 700512T (aux.) 700515T (aux.)	1,2,3	I _{OUT} = 10%, 50%, 100% rated V _{IN} = 60, 70, 100 Volts Notes 5,13	-50 -400 -500		50 400 500	mV mV mV
Cross regulation (V _{RCROSS}) 700512T (aux.) 700515T (aux.)	1,2,3	V _{IN} = 60, 70, 100 Volts I _{OUT} = 2.5A to 1A and 2.5A to 4A on main and ±half rated on aux. outputs	-3.5 -3.0		3.5 3.0	% %
Total regulation (VR) (main) 700512T (aux.) 700515T (aux.)	1,2,3	All conditions of Line, Load, and Cross Regulation, and Temperature	4.90 ±11.00 ±13.50		5.10 ±13.20 ±16.50	V V V
Input current (I _{IN})	1,2,3	I _{OUT} = 0, Pin 3 open		35	50	mA
		Pin 3 shorted to pin 2		2	5	

For Notes to Specifications, refer to page 5

Electrical Performance Characteristics (continued)

Parameter	Group A Subgroup	Conditions -55°C ≤ T _C ≤ +125°C V _{IN} = 70V DC ± 5%, C _L = 0 unless otherwise specified	Limits			Unit
			Min	Nom	Max	
Input Ripple Current	1,2,3	I _{OUT} = 100% rated load		2	5	mA rms
Output ripple (V _{RIP}) (main) 700512T (aux.) 700515T (aux.)	1,2,3	V _{IN} = 60, 70, 100 Volts I _{OUT} = 100% rated load, Notes 5, 6		25 30 30	50 60 75	mV p-p mV p-p mV p-p
Switching frequency (F _S)	1,2,3	Sync. Input (Pin 4) open	450	500	550	KHz
Efficiency (E _{FF})	1,2,3	I _{OUT} = 100% rated load Note 5	78	82		%
Inhibit Input open circuit voltage drive current (sink) voltage range	1,2,3	Note 1	3.0 -0.5		5.0 100 50	V μA V
Synchronization Input frequency range pulse high level pulse low level pulse transition time pulse duty cycle	1,2,3	Ext. Clock on Sync. Input (Pin 4) Note 1	450 4.0 -0.5 40 20		600 10.0 0.5 80	Khz V V V/μS %
Current Limit Point Expressed as a percentage of full rated output power	1,2,3	V _{out} = 90% of Nominal, Note 5			135	%
Power dissipation, load fault (P _D)	1,2,3	Short Circuit, Overload, Note 8			18	W
Output response to step load changes (V _{TLD})	4,5,6	Half Load to/from Full Load, Notes 5,9	-300		300	mV pk
Recovery time, step load changes (T _{TLD})	4,5,6	Half Load to/from Full Load, Note 5,9,10		50	200	μS
Output response to step line changes (V _{TLN})	4,5,6	60V to/from 100V I _{OUT} = 100% rated load, Notes 5,11	-300		300	mV pk
Recovery time, step line changes (T _{TLN})	4,5,6	60V to/from 100V I _{OUT} = 100% rated load, Notes 5,10,11		50	200	μS
Turn-on Response Overshoot (V _{OS}) (main) (aux.) Turn-on Delay (T _{DLY})	4,5,6	No Load, Full Load Notes 5,12	1		500 750 5	mV mV mS
Capacitive Load (CL) (main) (Each aux. output)	1	I _{OUT} = 100% rated load, No effect on DC performance, Notes 1, 5, 7			1000 200	μF μF
Line Rejection	1	DC to 50KHz, Notes 1, 5 I _{OUT} = 100% rated load	40	60		dB
Isolation	1	Input to Output or Any Pin to Case except pin 10, test @ 500VDC	100			MΩ
Device Weight					90	gms
MTBF		MIL-HDBK-217F2, SF, 35°C	5 x 10 ⁶			Hours

For Notes to Specifications, refer to page 5

Electrical Performance Characteristics (continued)Table I. Electrical Performance Characteristics - notes

1. Parameter is tested as part of design characterization or after design changes. Thereafter, parameter shall be guaranteed to the limits specified.
2. Parameter verified during line and load regulation tests.
3. Although operation with no load is permissible, light loading on the main (+5 volt) output may cause the output voltage of the auxiliary outputs (± 12 volt or ± 15 volt) to drop out of regulation. It is therefore recommended that at least 200 mA or 20 percent of the total output power, whichever is greater, be taken from the main (+5 volt) output.
4. Although operation with no load is permissible, heavy loading on the main (+5 volt) output may cause the output voltage of the auxiliary outputs (± 12 volt or ± 15 volt) to rise out of regulation. It is therefore recommended that at least 50 mA or 20 percent of the total output power, whichever is greater, be taken from the auxiliary (± 12 volt or ± 15 volt) outputs.
5. Unless otherwise specified, "Rated" load is 20W on the main (+5 volt) output and 10 watts each on the auxiliary (± 12 volt or ± 15 volt) outputs. Load currents of up to 5A and ± 1 A on the main and auxiliary outputs respectively are acceptable as long as the total output power does not to exceed 40 watts.
6. Guaranteed for a D.C. to 20MHz bandwidth. Tested using a 20KHz to 10MHz bandwidth.
7. Capacitive load may be any value from 0 to the maximum limit without compromising dc performance. A capacitive load in excess of the maximum limit may interfere with the proper operation of the converter's overload protection, causing erratic behavior during turn-on.
8. Overload power dissipation is defined as the device power dissipation with the load set such that $V_{OUT} = 90\%$ of nominal.
9. Load step transition time $\leq 10 \mu\text{Sec}$.
10. Recovery time is measured from the initiation of the transient to where V_{OUT} has returned to within $\pm 1\%$ of its steady state value.
11. Line step transition time $\leq 100 \mu\text{Sec}$.
12. Turn-on delay time from either a step application of input power or a logic low to a logic high transition on the inhibit pin (pin 3) to the point where $V_{OUT} = 90\%$ of nominal.
13. Load Regulation relative to output voltage at 50% rated load.
14. Line Regulation relative to output voltage at 70Vdc input.
15. For operation at temperatures between $+85^{\circ}\text{C}$ and $+125^{\circ}\text{C}$, derate the maximum input voltage linearly from 120V to 80V.

Radiation Performance Characteristics

Test	Conditions	Min	Typ	Unit
Total Ionizing Dose (Gamma)	MIL-STD-883, Method 1019 Operating bias applied during exposure, Full Rated Load, $V_{IN} = 70V$	100	300	KRads (Si)
Dose Rate (Gamma Dot) Temporary Saturation Survival	MIL-STD-883, Method 1023 Operating bias applied during exposure, Full Rated Load, $V_{IN} = 70V$	1E8 4E10	1E11	Rads (Si)/sec
Neutron Fluence	MIL-STD-883, Method 1017	8E12	1E13	Neutrons /cm ²
Single Event Effects SEU, SEL, SEGR, SEB	Heavy ions (LET) Operating bias applied during exposure, Full Rated Load, $V_{IN} = 70V$	82		MeV•cm ² /mg

Device Screening

Test Inspection	Method	Condition
Element Evaluation	MIL-PRF-38534 Space Requirement	
Nondestructive Bond Pull	MIL-STD-883, Method 2023	
Internal Visual	MIL-STD-883, Method 2017	
Temperature Cycling	MIL-STD-883, Method 1010	C
Constant Acceleration	MIL-STD-883, Method 2001	A, Y1 axis only
PIND	MIL-STD-883, Method 2020	A
Electrical	In accordance with device specification	
Burn-in	MIL-STD-883, Method 1015	320 Hours
Final Electrical (Group A)	In accordance with device specification	
Seal Fine Leak Gross Leak	MIL-STD-883, Method 1014	A1 C
Radiographic	MIL-STD-883, Method 2012	
External Visual	MIL-STD-883, Method 2009	

Block Diagram - Triple Output

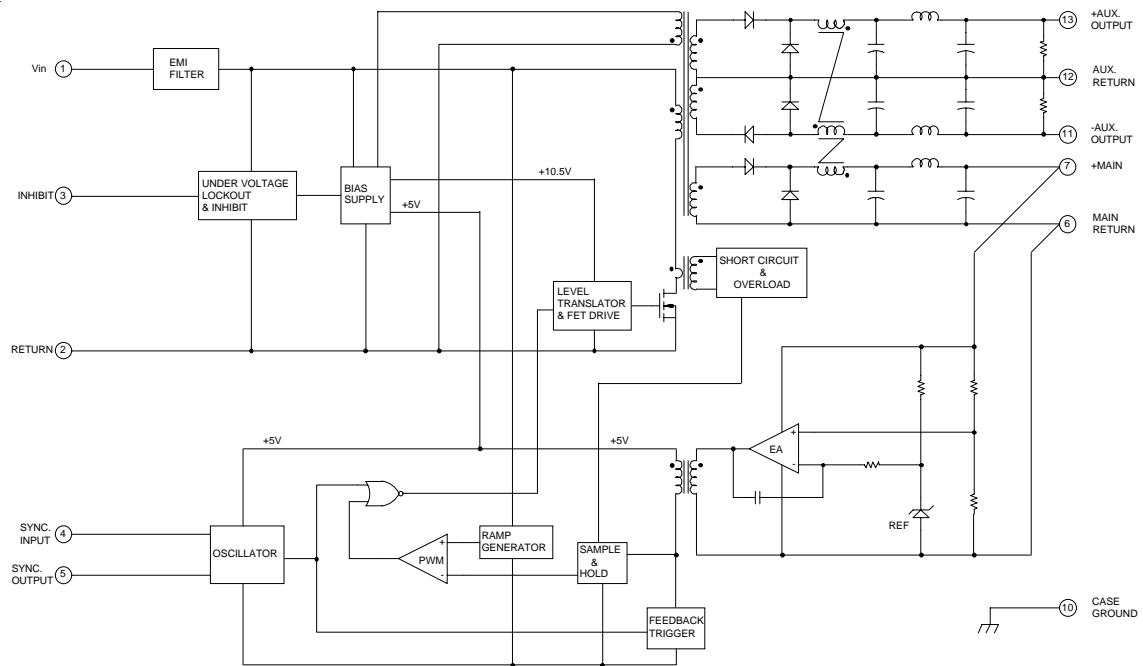

±12V Load Regulation vs 5V Load

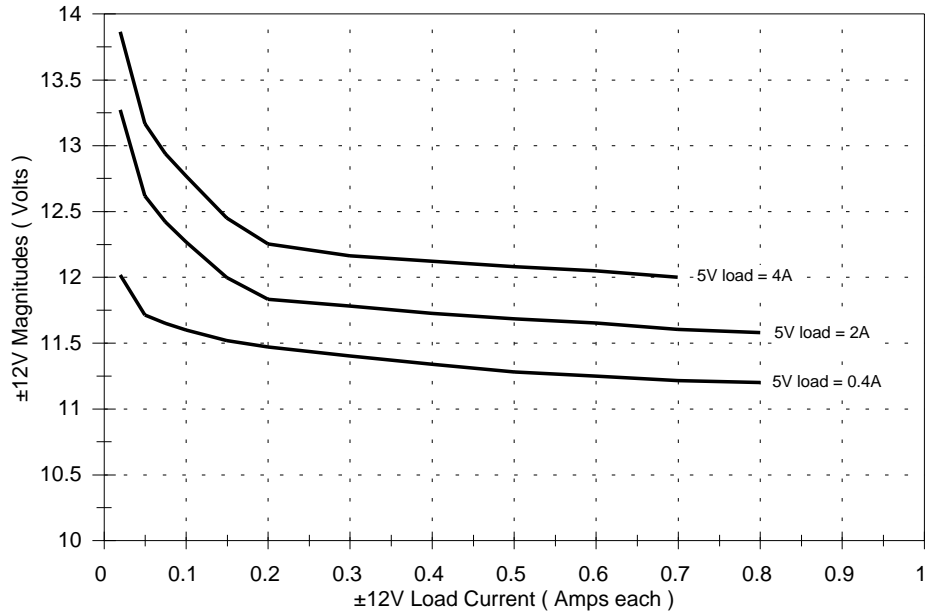

±15V Load Regulation vs 5V Load

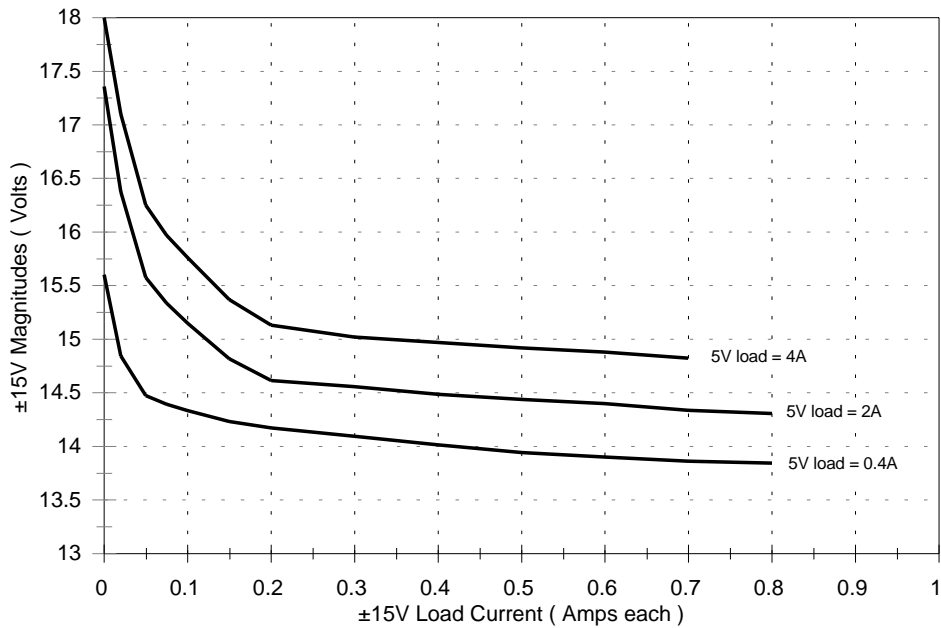

Line Rejection, Main Output

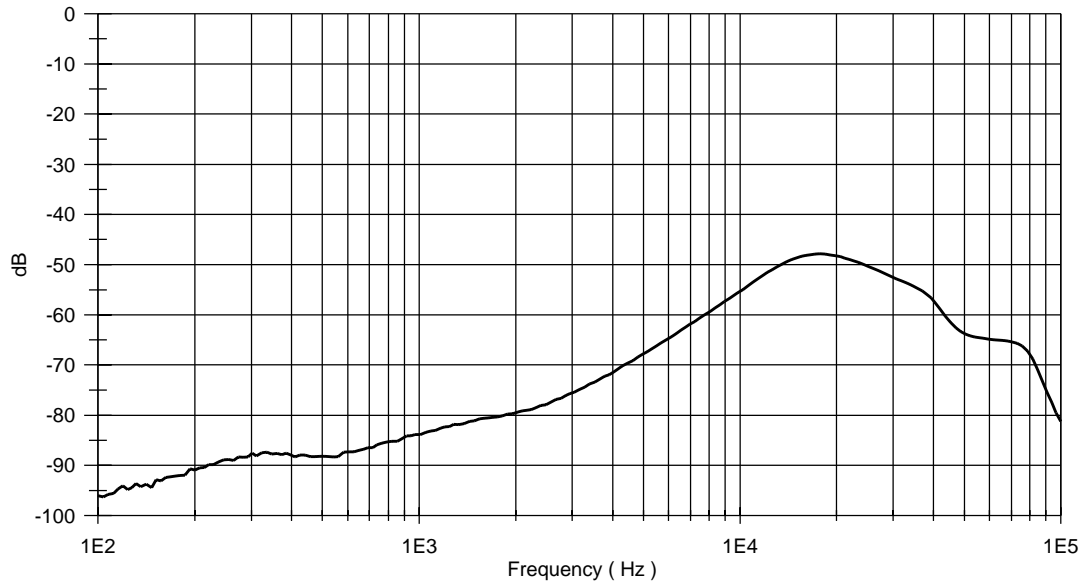

Line Rejection, Aux. Outputs

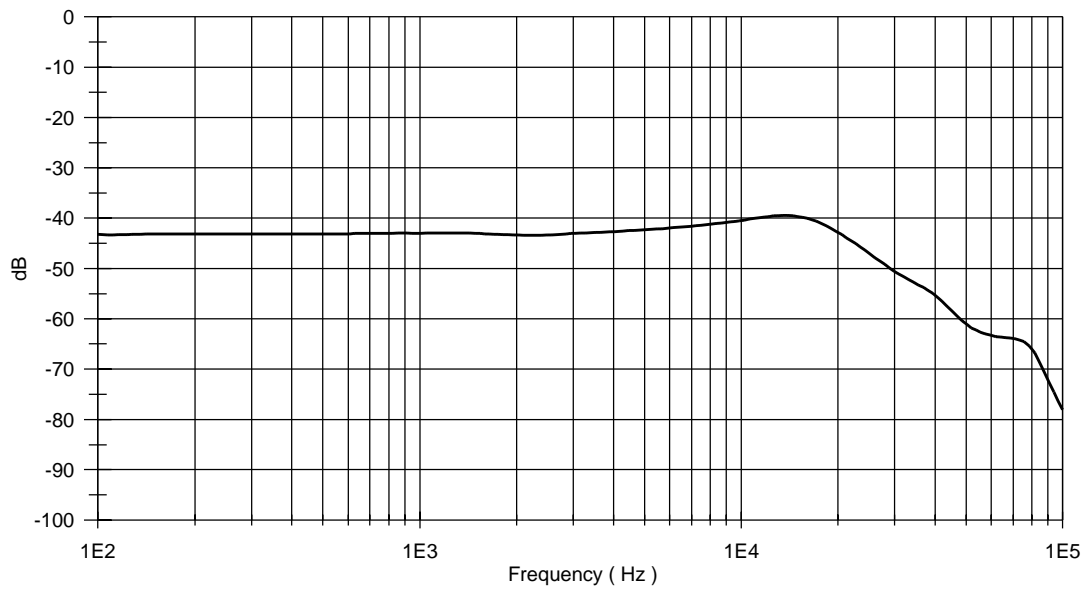

Conducted Emissions, Normal Mode

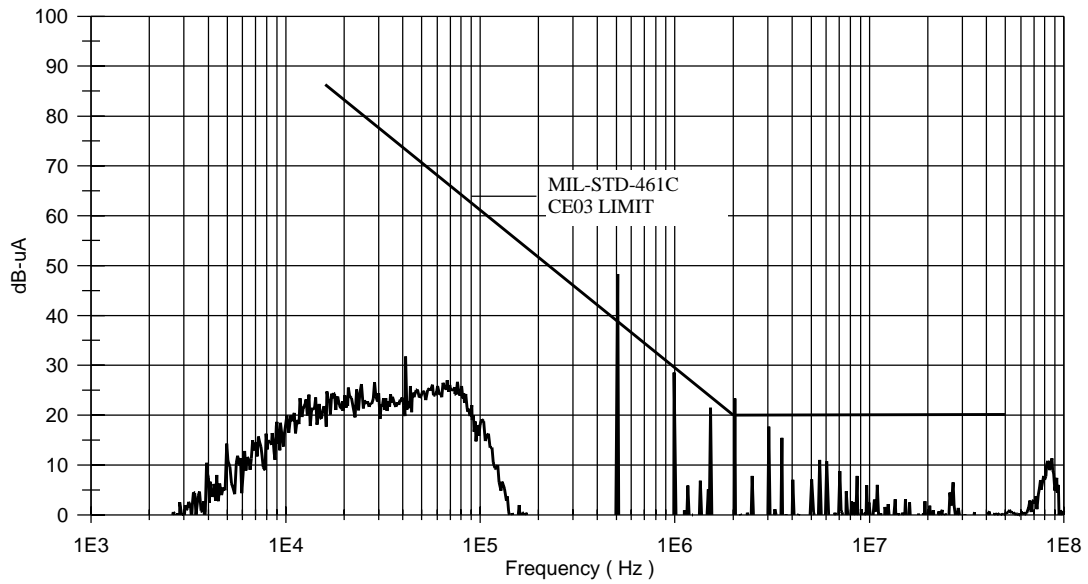

Conducted Emissions, Common Mode

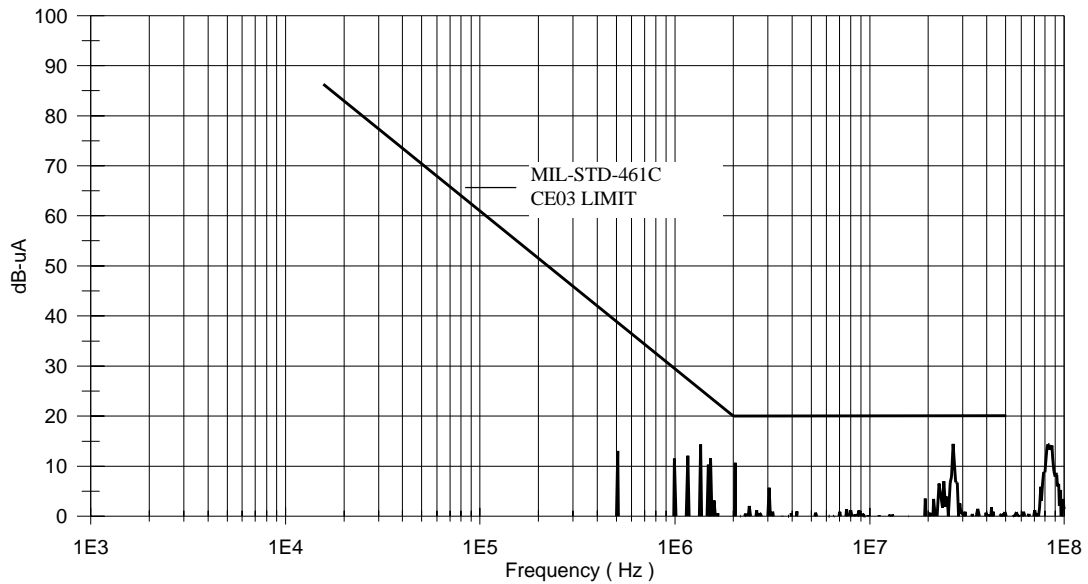

Mechanical Diagram

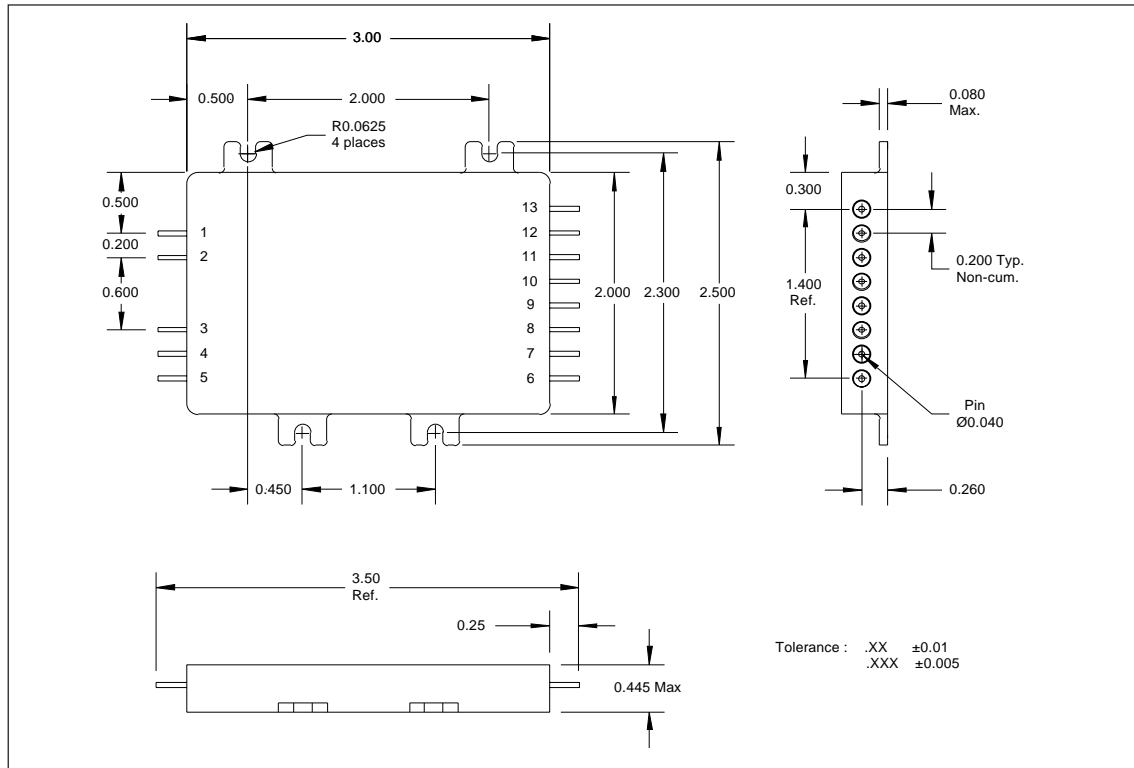

Pin Designation (Triple Output)

Pin	Signal	Pin	Signal
Pin 1	+V	Pin 8	N/C
Pin 2	Input Return	Pin 9	N/C
Pin 3	Inhibit	Pin 10	Case Ground
Pin 4	Sync. Input	Pin 11	-Aux. Output
Pin 5	Sync. Output	Pin 12	Aux. Output Return
Pin 6	Main Return	Pin 13	+Aux. Output
Pin 7	+Main Output		

Part Number

M3G 70 0515 T

Model ————
 Input Voltage ———— 70 = 70V Nominal
 Outputs ———— T = Triple
 Output Voltage ———— 0512 = 5V, ±12V
 0515 = 5V, ±15V