

PLEASE CHECK WWW.MOLEX.COM FOR LATEST PART INFORMATION

Part Number: [0355720600](#)
Status: **Active**
Description: 2.50mm (.098") Pitch Wire-to-Wire and Wire-to-Board Housing, Positive Lock, Nylon 6/6 Material, 6 Circuits, Natural

Documents:

[Drawing \(PDF\)](#) [RoHS Certificate of Compliance \(PDF\)](#)
[Product Specification PS-35572-001 \(PDF\)](#)

General

Product Family	Crimp Housings
Series	35572
Product Name	N/A

Physical

Breakaway	No
Circuits (maximum)	6
Color - Resin	Natural
Gender	Female
Glow-Wire Compliant	No
Keying to Mating Part	None
Lock to Mating Part	Yes
Material - Resin	Polyester
Number of Rows	1
Packaging Type	Bag
Panel Mount	No
Pitch - Mating Interface (in)	0.098 In
Pitch - Mating Interface (mm)	2.50 mm
Temperature Range - Operating	-40°C to +105°C

Material Info

Reference - Drawing Numbers

Product Specification	PS-35572-001
Sales Drawing	SD-35572-001

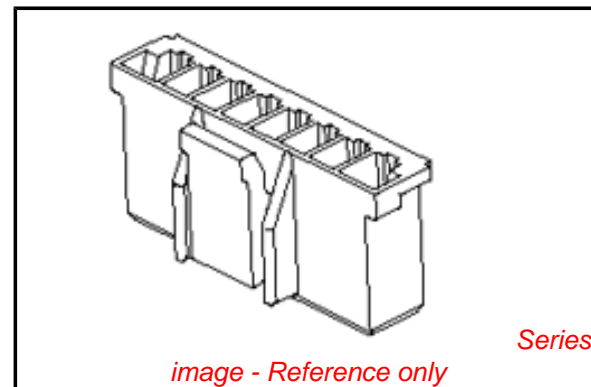

EU RoHS

ELV and RoHS Compliant
REACH SVHC Contains SVHC: No
Halogen-Free Status

China RoHS



Need more information on product environmental compliance?

Email productcompliance@molex.com
 For a multiple part number RoHS Certificate of Compliance, [click here](#)

Please visit the [Contact Us](#) section for any non-product compliance questions.

Search Parts in this Series

[35572Series](#)

Mates With

[35312](#) Vertical Shrouded Header, [35184](#) Plug Housing

Use With

[57915](#) Wire-to-Board Terminal

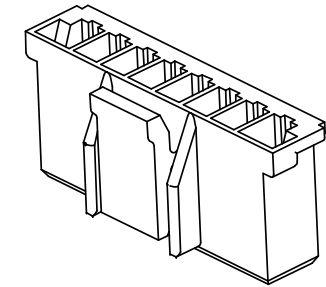
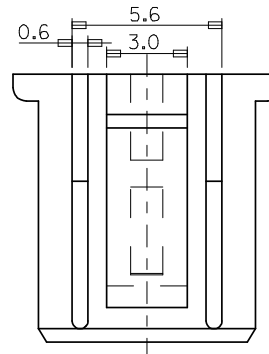
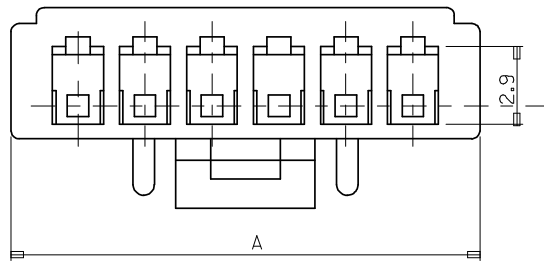

3 CKT ONLY

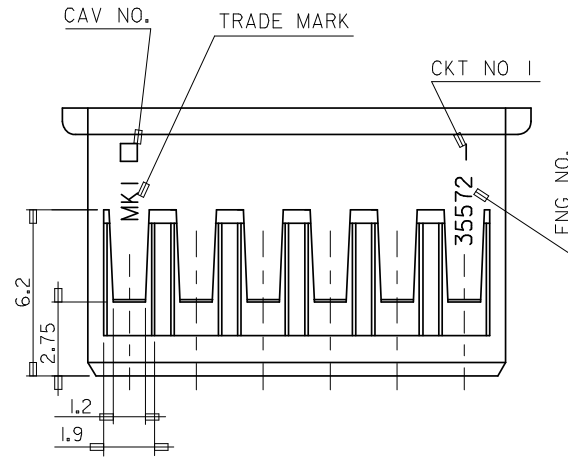
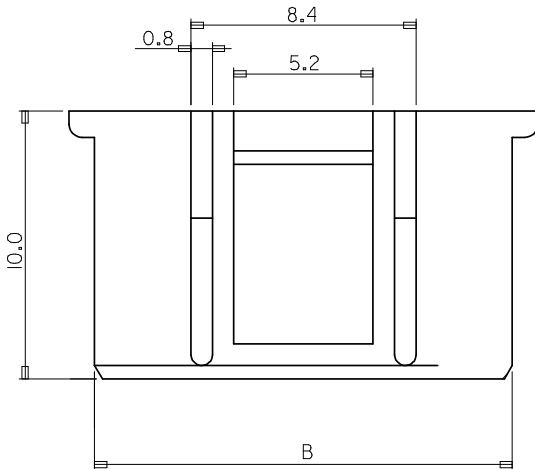
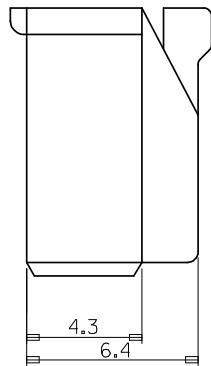

NOTE

1. MATERIAL : PBT UL94V-0 (VALOX 3IOSEO)
2. COLOR : 0 : NATURAL
2 : RED (ONLY 4P,6P,10P)
3. USED TERMINAL : 57915-9002/8001
4. MATED : 35312/35184

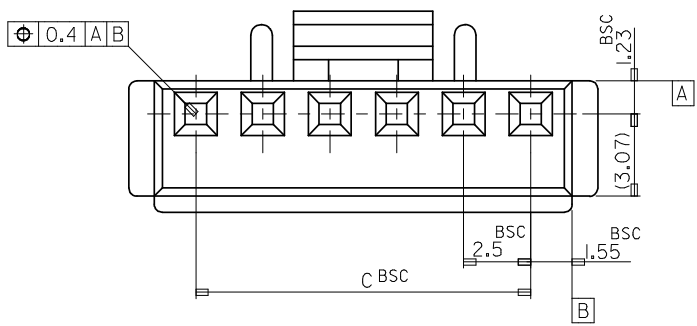

					20.0	23.1	25.0	35572-0900	9
35.0	38.1	40.0	35572-1500	15	17.5	20.6	22.5	35572-0800	8
32.5	35.6	37.5	35572-1400	14	15.0	18.1	20.0	35572-0700	7
30.0	33.1	35.0	35572-1300	13	12.5	15.6	17.5	35572-060*	6
27.5	30.6	32.5	35572-1200	12	10.0	13.1	15.0	35572-0500	5
25.0	28.1	30.0	35572-1100	11	7.5	10.6	12.5	35572-040*	4
22.5	25.6	27.5	35572-100*	10	5.0	8.1	10.0	35572-0300	3
C	B	A	ENG NO.	CKT	C	B	A	ENG NO.	CKT

REVISED EC NO: KOR2008-0109 DRWN: JHPARK01 2008/01/02 CHKD: WY. YANG 2008/01/02 APPR: YUNS IKK IM 2008/01/02	QUALITY SYMBOLS 	GENERAL TOLERANCES (UNLESS SPECIFIED)		DIMENSION STYLE MM ONLY		SCALE 5:1	DESIGN UNITS METRIC	THIRD ANGLE PROJECTION	
		4 PLACES ± --- ± --- 3 PLACES ± --- ± --- 2 PLACES ± --- ± --- 1 PLACE ± 0.2 ± --- ANGULAR ± 1°	mm INCH DRAWN BY DATE HS. SHIN 2000/02/17 CHECKED BY DATE JK. OH 2000/02/17 APPROVED BY DATE CW. LEE 2000/02/17	2.5 PITCH W/B CONN HOUSING			MOLEX INCORPORATED		
DRAFT WHERE APPLICABLE MUST REMAIN WITHIN DIMENSIONS	MATERIAL NO. SD35572.DGN		DOCUMENT NO. SD-35572-001		SHEET NO. 1 OF 01		THIS DRAWING CONTAINS INFORMATION THAT IS PROPRIETARY TO MOLEX INCORPORATED AND SHOULD NOT BE USED WITHOUT WRITTEN PERMISSION		