

**LH28F004SUB-Z9
4 Mbit (512 Kbit x 8)
3.3V (V_{pp}=5V) Flash Memory**

CONTENTS	PAGE	CONTENTS	PAGE
FEATURES	2	6.0 ELECTRICAL SPECIFICATIONS	24
1.0 INTRODUCTION	3	6.1 Absolute Maximum Ratings	24
1.1 Product Overview	3	6.2 Capacitance	24
2.0 DEVICE PINOUT	4	6.3 Timing Nomenclature	25
2.1 Lead Descriptions	6	6.4 DC Characteristics	27
3.0 MEMORY MAPS	8	6.5 AC Characteristics-Read Only Operations	29
4.0 BUS OPERATIONS, COMMANDS AND STATUS REGISTER DEFINITIONS	9	6.6 Power-Up and Reset Timings	32
4.1 Bus Operations	9	6.7 AC Characteristics for WE# - Controlled Command Write Operations	33
4.2 LH28F008SA-Compatible Mode Command Bus Definitions	10	6.8 AC Characteristics for CE# - Controlled Command Write Operations	35
4.3 LH28F004SUB-Z9 - Performance Enhancement Command Bus Definitions	11	6.9 Erase and Byte Write Performance	37
4.4 Compatible Status Register	12	7.0 PACKAGE AND PACKING SPECIFICATIONS	38
5.0 4M FLASH MEMORY SOFTWARE ALGORITHMS	13		
5.1 Overview	13		
5.2 4M Flash Memory Algorithm Flowcharts	14		

LH28F004SUB-Z9
4 MBIT (512 KBIT x 8)
3.3V ($V_{pp}=5V$) FLASH MEMORY

FEATURES

- 32 Independently Lockable Blocks
- 10,000 Erase Cycles per Block
- 2.7V Write/Erase Operation ($5V \pm 0.5V V_{pp}$, $3.0V \pm 0.3V V_{cc}$, $+15^{\circ}C$ to $+35^{\circ}C$)
 - No Requirement for DC/DC Converter to Write/Erase
- 512 Kbit x 8 Word Configuration
- 150 ns Maximum Access Time ($V_{cc}=3.3V \pm 0.3V$)
- Min. 2.7V Read Capability
 - 190 ns Maximum Access Time ($V_{cc}=2.7V$, $-20^{\circ}C$ to $+85^{\circ}C$)
 - 180 ns Maximum Access Time ($V_{cc}=2.7V$, $0^{\circ}C$ to $+70^{\circ}C$)
- Automated Byte Write/Block Erase
 - Command User Interface
 - Status Register
 - RY/BY# Status Output
- 42-Lead, 0.67mm x 8mm x 8mm CSP Package
- System Performance Enhancement
 - Erase Suspend for Read
 - Two-Byte Write
 - Full Chip Erase
- Data Protection
 - Hardware Erase/Write Lockout during Power Transitions
 - Software Erase/Write Lockout
- Independently Lockable for Write/Erase on Each Block (Lock Block & Protect Set/Reset)
- 4 μA (Typ.) I_{cc} in CMOS Standby
- 0.2 μA (Typ.) Deep Power-Down
- State-of-the-Art 0.45 μm ETOX™ Flash Technology
- Extended Temperature Operation
 - $-20^{\circ}C$ to $+85^{\circ}C$ (Read)
 - $+15^{\circ}C$ to $+35^{\circ}C$ (Write/Erase)
- Not designed or rated as radiation hardened

Sharp's LH28F004SUB-Z9 4-Mbit Flash Memory is a revolutionary architecture which enables the design of truly mobile, high performance, personal computing and communication products. With innovative capabilities, 3.3V low power operation and very high read/write performance, the LH28F004SUB-Z9 is also the ideal choice for designing embedded mass storage flash memory systems.

The LH28F004SUB-Z9's independently lockable 32 symmetrical blocked architecture (16-Kbyte each) extended cycling, low power operation, very fast write and read performance and selective block locking provide a highly flexible memory component suitable for Cellular phone, Facsimile, Game, PC, Printer and Handy terminal. The LH28F004SUB-Z9's 5.0V/3.3V power supply operation enables the design of memory cards which can be read in 3.3V system and written in 5.0V/3.3V systems. Its x8 architecture allows the optimization of memory to processor interface. The flexible block locking option enables bundling of executable application software in a Resident Flash Array or memory card. Manufactured on Sharp's 0.45 μm ETOX™ process technology, the LH28F004SUB-Z9 is the most cost-effective, high-density 3.3V flash memory.

* ETOX is a trademark of Intel corporation.

1.0 INTRODUCTION

The data sheet is intended to give an overview of the chip feature-set and of the operating AC/DC specifications.

1.1 Product Overview

The LH28F004SUB-Z9 is a high performance 4-Mbit (4,194,304 bit) block erasable non-volatile random access memory organized as 512 Kbyte x 8. The LH28F004SUB-Z9 includes thirty-two 16 KB (16,384) blocks. A chip memory map is shown in Figure 3.

The implementation of a new architecture, with many enhanced features, will improve the device operating characteristics and results in greater product reliability and ease of use.

Among the significant enhancements of the LH28F004SUB-Z9:

- 3V Read, 5V Write/Erase Operation (5V V_{PP} , 2.7V V_{CC})
- Low Power Capability (2.7V V_{CC} Read and Write/Erase)
- Improved Write Performance
- Dedicated Block Write/Erase Protection
- Command-Controlled Memory Protection Set/Reset Capability

The LH28F004SUB-Z9 will be available in a 42-lead, 0.67mm thick, 8mm x 8mm CSP package. This form factor and pinout allow for very high board layout densities.

A Command User Interface (CUI) serves as the system interface between the microprocessor or micro-controller and the internal memory operation.

Internal Algorithm Automation allows Byte Writes and Block Erase operations to be executed using a Two-Write command sequence to the CUI in the same way as the LH28F008SA 8-Mbit Flash memory.

A Superset of commands have been added to the basic LH28F008SA command-set to achieve higher write performance and provide additional capabilities. These new commands and features include:

- Software Locking of Memory Blocks
- Memory Protection Set/Reset Capability
- Two-Byte Serial Writes in 8-bit Systems
- Erase All Unlocked Blocks

Writing of memory data is performed typically within TBD μ sec. A Block Erase operation erases one of the 32 blocks in typically TBD sec, independent of the other blocks.

LH28F004SUB-Z9 allows to erase all unlocked blocks. It is desirable in case of which you have to implement Erase operation max. 32 times.

LH28F004SUB-Z9 enables Two-Byte serial Write which is operated by three times command input. Writing of memory data is performed typically within TBD μ sec per two-byte. This feature can improve system write performance by up to typically TBD μ sec per byte.

All operations are started by a sequence of Write commands to the device. Status Register (described in detail later) and a RY/BY# output pin provide information on the progress of the requested operation.

Same as the LH28F008SA, LH28F004SUB-Z9 requires an operation to complete before the next operation can be requested, also it allows to suspend block erase to read data from any other block, and allow to resume erase operation.

The LH28F004SUB-Z9 provides user-selectable block locking to protect code or data such as Device Drivers, PCMCIA card information, ROM-Executable OS or Application Code. Each block has an associated non-volatile lock-bit which determines the lock status of the block. In addition, the LH28F004SUB-Z9 has a software controlled master Write Protect circuit which prevents any modifications to memory blocks whose lock-bits are set.

When the device power-up or RP# turns High, Write Protect Set/Confirm command must be written. Otherwise, all lock bits in the device remain being locked, can't perform the Write to each block and single Block Erase. Write Protect Set/Confirm command must be written to reflect the actual lock status. However, when the device power-on or RP# turns High, Erase All Unlocked Blocks can be used. If used, Erase is performed with reflecting actual lock status, and after that Write and Block Erase can be used.

The LH28F004SUB-Z9 contains a Compatible Status Register (CSR) which is 100% compatible with the LH28F008SA Flash memory's Status Register. This register, when used alone, provides a straightforward upgrade capability to the LH28F004SUB-Z9 from a LH28F008SA-based design.

The LH28F004SUB-Z9 incorporates an open drain RY/BY# output pin. This feature allows the user to OR-tie many RY/BY# pins together in a multiple memory configuration such as a Resident Flash Array.

The LH28F004SUB-Z9 is specified for a maximum access time of 150 nsec (t_{ACC}) at 3.3V operation (3.0 to 3.6V) over the commercial temperature range (-20 to +85°C). A corresponding maximum access time of 190 nsec (t_{ACC}) at 2.7V (-20 to +85°C) and 180 nsec (t_{ACC}) at 2.7V (0 to +70°C) is achieved for reduced power consumption applications.

The LH28F004SUB-Z9 incorporates an Automatic Power Saving (APS) feature which substantially reduces the active current when the device is in static mode of operation (addresses not switching).

In APS mode, the typical I_{CC} current is 1 mA at 3.3V.

A Deep Power-Down mode of operation is invoked when the RP# (called PWD# on the LH28F008SA) pin transitions low, any current operation is aborted and the device is put into the deep power down mode. This mode brings the device power consumption to less than 8 μ A, and provides additional write protection by acting as a device reset pin during power transitions. When the power is turned on, RP# pin is turned to low in order to return the device to default configuration. When the power transition is occurred, or at the power on/off, RP# is required to stay low in order to protect data from noise. A recovery time of 750ns is required from RP# switching high until outputs are again valid. In the Deep Power-Down state, the WSM is reset (any current operation will abort) and the CSR register is cleared.

A CMOS Standby mode of operation is enabled when CE# transitions high and RP# stays high with all input control pins at CMOS levels. In this mode, the device draws an I_{CC} standby current of 15 μ A.

2.0 DEVICE PINOUT

The LH28F004SUB-Z9 42-Lead CSP pinout configuration is shown in Figure 2.

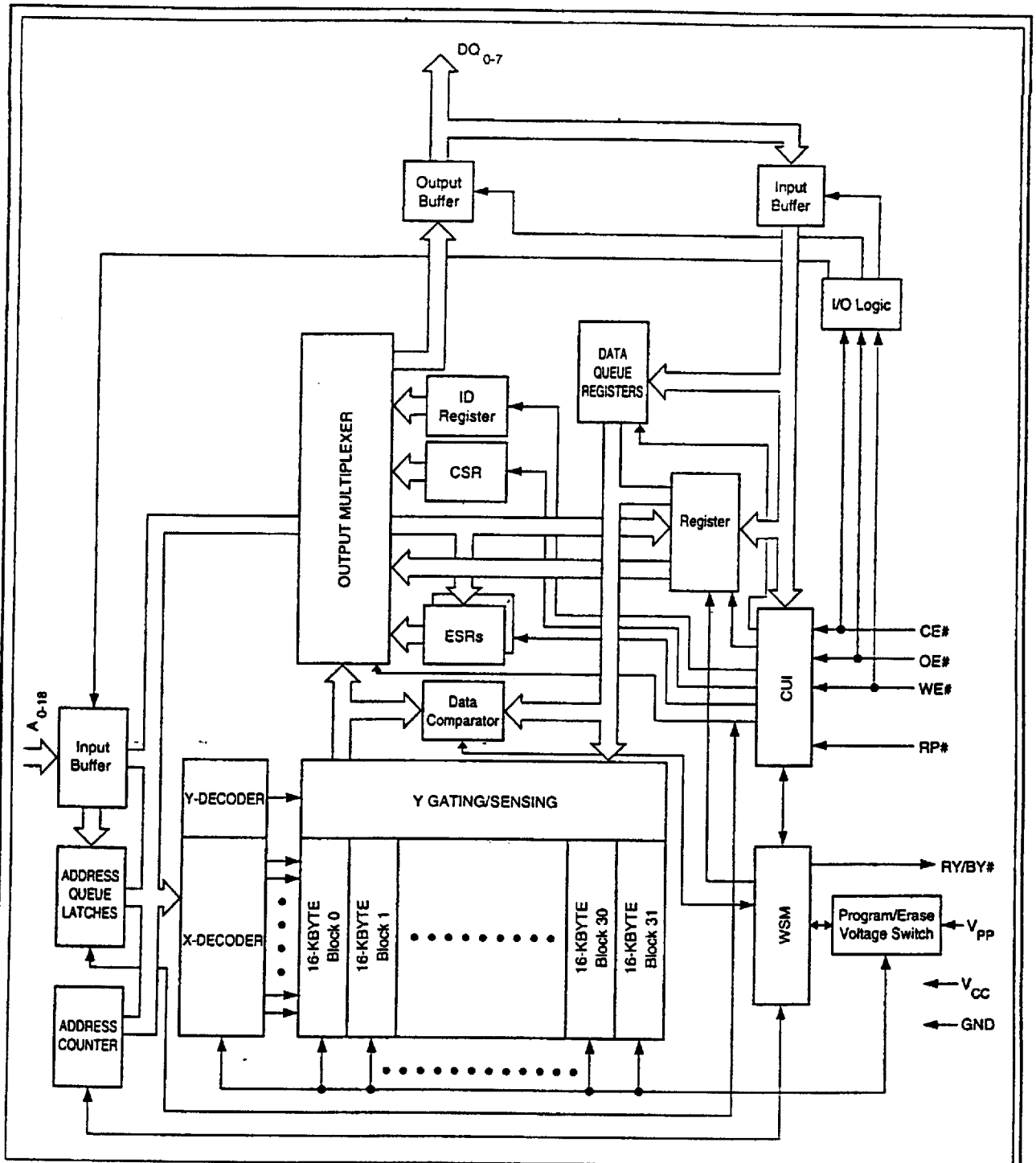
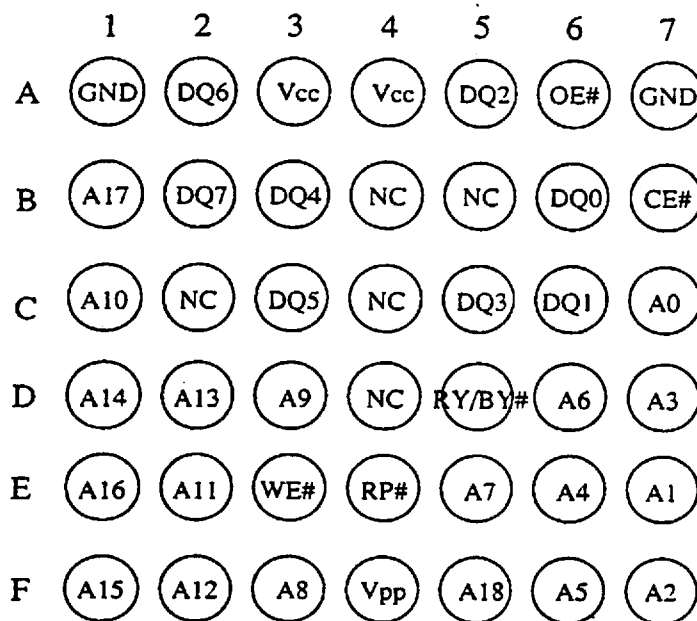

Figure 1. LH28F004SUB-Z9 Block Diagram

2.1 Lead Descriptions

Symbol	Type	Name and Function
A ₀ -A ₁₃	INPUT	WORD-SELECT ADDRESSES: Select a word within one 16-Kbyte block. These addresses are latched during Data Writes.
A ₁₄ -A ₁₈	INPUT	BLOCK-SELECT ADDRESSES: Select 1 of 32 Erase blocks. These addresses are latched during Data Writes, Erase and Lock-Block operations.
DQ ₀ -DQ ₇	INPUT/OUTPUT	DATA INPUT/OUTPUT: Inputs data and commands during CUI write cycles. Outputs array, buffer, identifier or status data in the appropriate Read mode. Floated when the chip is de-selected or the outputs are disabled.
CE#	INPUT	CHIP ENABLE INPUTS: Activate the device's control logic, input buffers, decoders and sense amplifiers. CE# must be low to select the device.
RP#	INPUT	RESET/POWER-DOWN: With RP# low, the device is reset, any current operation is aborted and device is put into the deep power down mode. When the power is turned on, RP# pin is turned to low in order to return the device to default configuration. When the power transition is occurred, or the power on/off, RP# is required to stay low in order to protect data from noise. When returning from Deep Power-Down, a recovery time of 750ns is required to allow these circuits to power-up. When RP# goes low, any current or pending WSM operation(s) are terminated, and the device is reset. All Status registers return to ready (with all status flags cleared). After returning, the device is in read array mode.
OE#	INPUT	OUTPUT ENABLE: Gates device data through the output buffers when low. The outputs float to tri-state off when OE# is high.
WE#	INPUT	WRITE ENABLE: Controls access to the CUI, Data Queue Registers and Address Queue Latches. WE# is active low, and latches both address and data (command or array) on its rising edge.
RY/BY#	OPEN DRAIN OUTPUT	READY/BUSY: Indicates status of the internal WSM. When low, it indicates that the WSM is busy performing an operation. When the WSM is ready for new operation or Erase is Suspended, or the device is in deep power-down mode RY/BY# pin is floated.
V _{PP}	SUPPLY	ERASE/WRITE POWER SUPPLY (5.0V ± 0.5V): For erasing memory array blocks or writing words/bytes into the flash array.
V _{CC}	SUPPLY	DEVICE POWER SUPPLY (Read 2.7V ~3.6V, Write/Erase 2.7V ~3.3V): Do not leave any power pins floating.
GND	SUPPLY	GROUND FOR ALL INTERNAL CIRCUITRY: Do not leave any ground pins floating.
NC		NO CONNECT: No internal connection to die, lead may be driven or left floating.



LH28F004SUB - Z9 (Top View)

Figure 2. CSP Configuration

3.0 MEMORY MAPS

7FFFFH	16 KByte Block	31
7C000H		
7BFFFH	16 KByte Block	30
78000H		
77FFFH	16 KByte Block	29
74000H		
73FFFH	16 KByte Block	28
70000H		
6FFFFH	16 KByte Block	27
6C000H		
6BFFFH	16 KByte Block	26
68000H		
67FFFH	16 KByte Block	25
64000H		
63FFFH	16 KByte Block	24
60000H		
5FFFFH	16 KByte Block	23
5C000H		
5BFFFH	16 KByte Block	22
58000H		
57FFFH	16 KByte Block	21
54000H		
53FFFH	16 KByte Block	20
50000H		
4FFFFH	16 KByte Block	19
4C000H		
4BFFFH	16 KByte Block	18
48000H		
47FFFH	16 KByte Block	17
44000H		
43FFFH	16 KByte Block	16
40000H		
3FFFFH	16 KByte Block	15
3C000H		
3BFFFH	16 KByte Block	14
38000H		
37FFFH	16 KByte Block	13
34000H		
33FFFH	16 KByte Block	12
30000H		
2FFFFH	16 KByte Block	11
2C000H		
2BFFFH	16 KByte Block	10
28000H		
27FFFH	16 KByte Block	9
24000H		
23FFFH	16 KByte Block	8
20000H		
1FFFFH	16 KByte Block	7
1C000H		
1BFFFH	16 KByte Block	6
18000H		
17FFFH	16 KByte Block	5
14000H		
13FFFH	16 KByte Block	4
10000H		
0FFFFH	16 KByte Block	3
0C000H		
0BFFFH	16 KByte Block	2
08000H		
07FFFH	16 KByte Block	1
04000H		
03FFFH	16 KByte Block	0
00000H		

Figure 3. LH28F004SUB-Z9 Memory Map (Byte-wide mode)

4.0 BUS OPERATIONS, COMMANDS AND STATUS REGISTER DEFINITIONS

4.1 Bus Operations

Mode	Notes	RP#	CE#	OE#	WE#	A ₀	DQ ₀₋₇	RY/BY#
Read	1,2,7	V _{IH}	V _{IL}	V _{IL}	V _{IH}	X	D _{OUT}	X
Output Disable	1,6,7	V _{IH}	V _{IL}	V _{IH}	V _{IH}	X	High Z	X
Standby	1,6,7	V _{IH}	V _{IH}	X	X	X	High Z	X
Deep Power-Down	1,3	V _{IL}	X	X	X	X	High Z	V _{OH}
Manufacturer ID	4	V _{IH}	V _{IL}	V _{IL}	V _{IH}	V _{IL}	B0H	V _{OH}
Device ID	4	V _{IH}	V _{IL}	V _{IL}	V _{IH}	V _{IH}	ID	V _{OH}
Write	1,5,6	V _{IH}	V _{IL}	V _{IH}	V _{IL}	X	D _{IN}	X

NOTES:

- X can be V_{IH} or V_{IL} for address or control pins except for RY/BY#, which is either V_{OL} or V_{OH}.
- RY/BY# output is open drain. When the WSM is ready, Erase is suspended or the device is in deep power-down mode, RY/BY# will be at V_{OH} if it is tied to V_{CC} through a resistor. When the RY/BY# at V_{OL} is independent of OE# while a WSM operation is in progress.
- RP# at GND ± 0.2V ensures the lowest deep power-down current.
- A₀ at V_{IL} provide manufacturer ID codes.
- A₀ at V_{IH} provide device ID codes. Device ID Code = 23H.
- All other addresses are set to zero.
- Commands for different Erase operations, Data Write operations, and Lock-Block operations can only be successfully completed when V_{PP} = V_{PPH}.
- While the WSM is running, RY/BY# in Level-Mode (default) stays at V_{OL} until all operations are complete. RY/BY# goes to V_{OH} when the WSM is not busy or in erase suspend mode.
- RY/BY# may be at V_{OL} while the WSM is busy performing various operations. For example, a status register read during a write operation.

4.2 LH28F008SA-Compatible Mode Command Bus Definitions

Command	Notes	First Bus Cycle			Second Bus Cycle		
		Oper	Addr	Data	Oper	Addr	Data
Read Array		Write	X	FFH	Read	AA	AD
Intelligent Identifier	1	Write	X	90H	Read	IA	ID
Read Compatible Status Register	2	Write	X	70H	Read	X	CSRD
Clear Status Register	3	Write	X	50H			
Word Write		Write	X	40H	Write	WA	WD
Alternate Word Write		Write	X	10H	Write	WA	WD
Block Erase/Confirm	4	Write	X	20H	Write	BA	D0H
Erase Suspend/Resume	4	Write	X	B0H	Write	X	D0H

ADDRESS

AA = Array Address
 BA = Block Address
 IA = Identifier Address
 WA = Write Address
 X = Don't Care

DATA

AD = Array Data
 CSRD = CSR Data
 ID = Identifier Data
 WD = Write Data

NOTES:

- Following the intelligent identifier command, two Read operations access the manufacturer and device signature codes.
- The CSR is automatically available after device enters Data Write, Erase, or Suspend operations.
- Clears CSR.3, CSR.4 and CSR.5. See Status register definitions.
- While device performs Block Erase, if you issue Erase Suspend command (B0H), be sure to confirm ESS (Erase-Suspend-Status) is set to 1 on compatible status register. In the case, ESS bit was not set to 1, also completed the Erase (ESS=0, WSMS=1), be sure to issue Resume command (D0H) after completed next Erase command. Beside, when the Erase Suspend command is issued, while the device is not in Erase, be sure to issue Resume command (D0H) after the next erase completed.

4.3 LH28F004SUB-Z9 -Performance Enhancement Command Bus Definitions

Command	Mode	Notes	First Bus Cycle			Second Bus Cycle			Third Bus Cycle		
			Oper	Addr	Data	Oper	Addr	Data	Oper	Addr	Data
Protect Set/Confirm		1,2	Write	X	57H	Write	0FFH	D0H			
Protect Reset /Confirm		3	Write	X	47H	Write	0FFH	D0H			
Lock Block/Confirm		1,2,4	Write	X	77H	Write	BA	D0H			
Erase All Unlocked Blocks		1,2	Write	X	A7H	Write	X	D0H			
Two-Byte Write	x8	1,2,5	Write	X	FBH	Write	A10	WD(L,H)	Write	WA	WD(H,L)

ADDRESS

BA = Block Address

WA = Write Address

DATA

AD = Array Data

WD (L.H) = Write Data (Low, High)

WD (H.L) = Write Data (High, Low)

X = Don't Care

NOTES:

1. After initial device power-up, or return from deep power-down mode, the block lock status bits default to the locked state independent of the data in the corresponding lock bits. In order to upload the lock bit status, it requires to write Protect Set/Confirm command.
2. To reflect the actual lock-bit status, the Protect Set/Confirm command must be written after Lock Block/Confirm command.
3. When Protect Reset/Confirm command is written, all blocks can be written and erased regardless of the state of the lock-bits.
4. The Lock Block/Confirm command must be written after Protect Reset/Confirm command was written.
5. A_{10} is automatically complemented to load second byte of data. A_{10} value determines which WD is supplied first: $A_{10} = 0$ looks at the WDL, $A_{10} = 1$ looks at the WDH.
6. Second bus cycle address of Protect Set/Confirm and Protect Reset/Confirm command is 0FFH. Specifically $A_9-A_8 = 0$, $A_7-A_6 = 1$, others are don't care.

4.4 Compatible Status Register

WSMS	ESS	ES	DWS	VPPS	R	R	R
7	6	5	4	3	2	1	0

NOTES:

CSR.7 = WRITE STATE MACHINE STATUS (WSMS)

1 = Ready

0 = Busy

RY/BY# output or WSMS bit must be checked to determine completion of an operation (Erase Suspend, Erase or Data Write) before the appropriate Status bit (ESS, ES or DWS) is checked for success.

CSR.6 = ERASE-SUSPEND STATUS (ESS)

1 = Erase Suspended

0 = Erase in Progress/Completed

CSR.5 = ERASE STATUS (ES)

1 = Error in Block Erasure

0 = Successful Block Erase

If DWS and ES are set to "1" during an erase attempt, an improper command sequence was entered. Clear the CSR and attempt the operation again.

CSR.4 = DATA-WRITE STATUS (DWS)

1 = Error in Data Write

0 = Data Write Successful

CSR.3 = V_{PP} STATUS (VPPS)

1 = V_{PP} Low Detect, Operation Abort

0 = V_{PP} OK

The VPPS bit, unlike an A/D converter, does not provide continuous indication of V_{PP} level. The WSM interrogates V_{PP} 's level only after the Data-Write or Erase command sequences have been entered, and informs the system if V_{PP} has not been switched on. VPPS is not guaranteed to report accurate feedback between V_{PPL} and V_{PPH} .

CSR.2-0 = RESERVED FOR FUTURE ENHANCEMENTS

These bits are reserved for future use and should be masked out when polling the CSR.

5.0 4M FLASH MEMORY SOFTWARE ALGORITHMS

5.1 Overview

With the advanced Command User Interface, its Performance Enhancement commands and Status Registers, the software code required to perform a given operation may become more intensive but it will result in much higher write/erase performance compared with current flash memory architectures.

The software flowcharts describing how a given operation proceeds are shown here. Figures 5-1 through 5-3 depict flowcharts using the 2nd generation flash device in the LH28F008SA-compatible mode. Figures 5-4 through 5-9 depict flowcharts using the 2nd generation flash device's performance enhancement commands mode.

When the device power-up or the device is reset by RP# pin, all blocks come up locked. Therefore, Word/Byte Write, Two Byte Serial Write and Block Erase can not be performed in each block. However, at that time, Erase All Unlocked Block is performed normally, if used, and reflect actual lock status, also the unlocked block data is erased. When the device power-up or the device is reset by RP# pin, Set Write Protect command must be written to reflect actual block lock status.

Reset Write Protect command must be written before Write Block Lock command. To reflect actual block lock status, Set Write Protect command is succeeded.

The Compatible Status Register (CSR) is used to determine which blocks are locked. In order to see Lock Status of a certain block, a Word/Byte Write command (WA=Block Address, WD=FFH) is written to the CUI, after issuing Set Write Protect command. If CSR7, CSR5 and CSR4 (WSMS, ES and DWS) are set to "1"s, the block is locked. If CSR7 is set to "1", the block is not locked.

Reset Write Protect command enables Write/Erase operation to each block.

In the case of Block Erase is performed, the block lock information is also erased. Block Lock command and Set Write Protect command must be written to prohibit Write/Erase operation to each block.

There are unassigned commands. It is not recommended that the customer use any command other than the valid commands specified in Chapter 4 "Command Bus Definitions". Sharp reserved the right to redefine these codes for future functions.

Please do not execute reprogramming 0 for the bit which has already been programmed 0. Overwrite operation may generate unerasable bit. In case of reprogramming 0 to the Byte data which has been programmed 1.

- Program 0 for the bit in which you want to change data from 1 to 0.
- Program 1 for the bit which has already been programmed 0.

For example, changing Byte data from 1011 1101 to 1011 1100 requires 1111 1110 programming.

5.2 4M Flash Memory Algorithm Flowcharts

The following flowcharts describe the 2nd generation flash device modes of operation:

Figure 5-1	Word/Byte Writes with Compatible Status Register
Figure 5-2	Block Erase with Compatible Status Register
Figure 5-3	Erase Suspend to Read Array with Compatible Status Register
Figure 5-4	Block Locking Scheme
Figure 5-5	Updating Data in a Locked Block
Figure 5-6	Two-Byte Serial Writes with Compatible Status Registers
Figure 5-7	Erase All Unlocked Blocks with Compatible Status Registers
Figure 5-8	Set Write Protect
Figure 5-9	Reset Write Protect

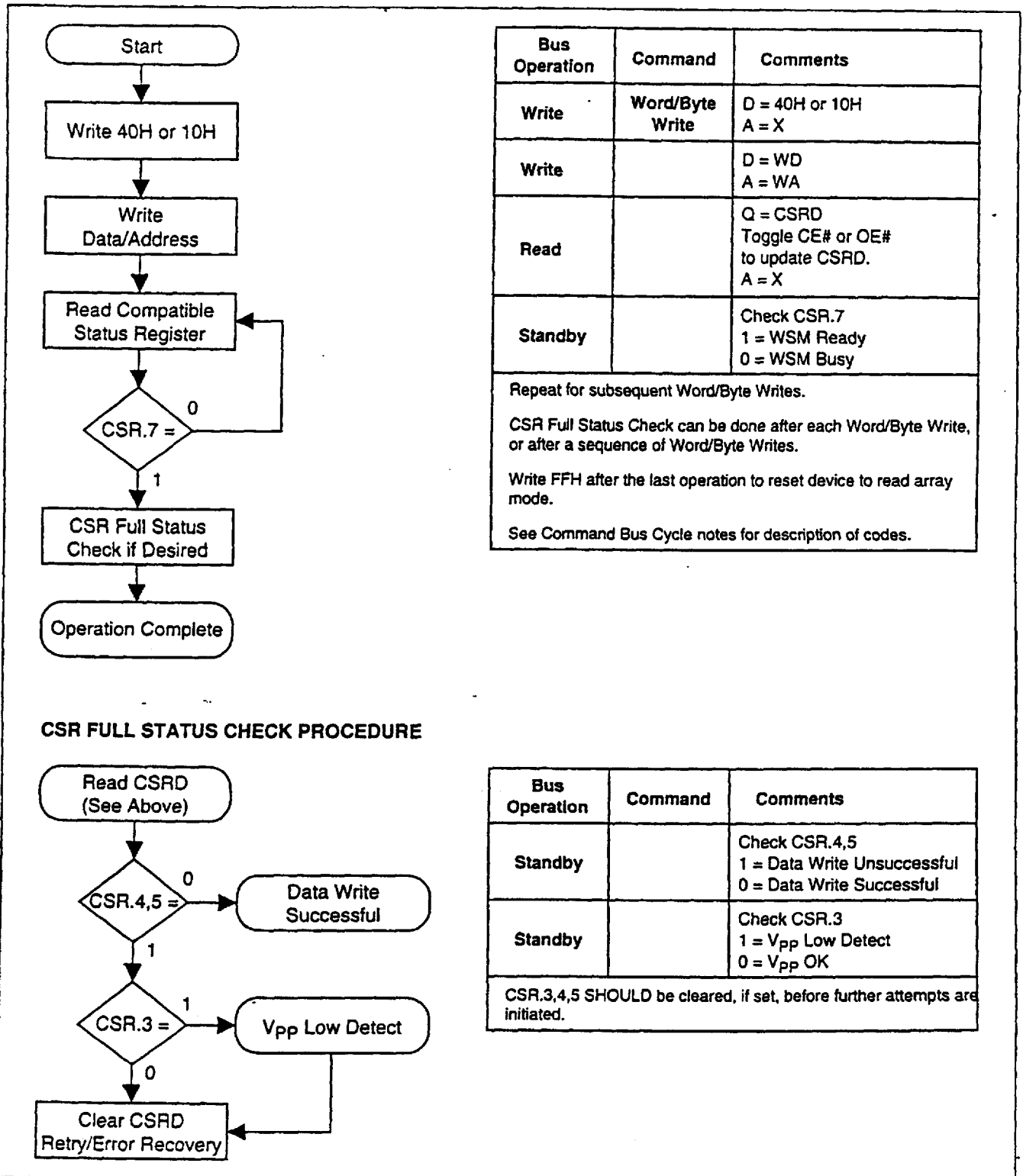
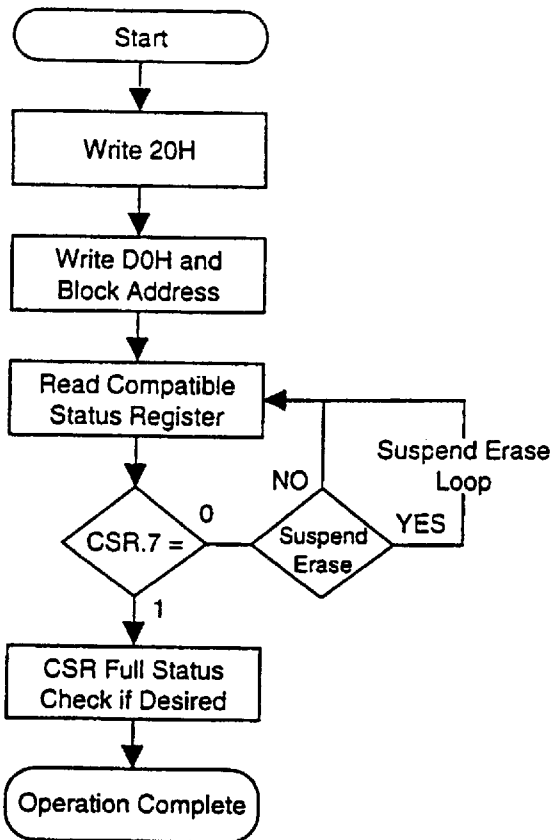

Figure 5-1. Word/Byte Writes with Compatible Status Register



Bus Operation	Command	Comments
Write	Block Erase	D = 20H A = X
Write	Confirm	D = D0H A = BA
Read		Q = CSR.D Toggle CE# or OE# to update CSR.D. A = X
Standby		Check CSR.7 1 = WSM Ready 0 = WSM Busy

Repeat for subsequent Block Erasures.

CSR Full Status Check can be done after each Block Erase, or after a sequence of Block Erasures.

Write FFH after the last operation to reset device to read array mode.

See Command Bus Cycle notes for description of codes.

CSR FULL STATUS CHECK PROCEDURE

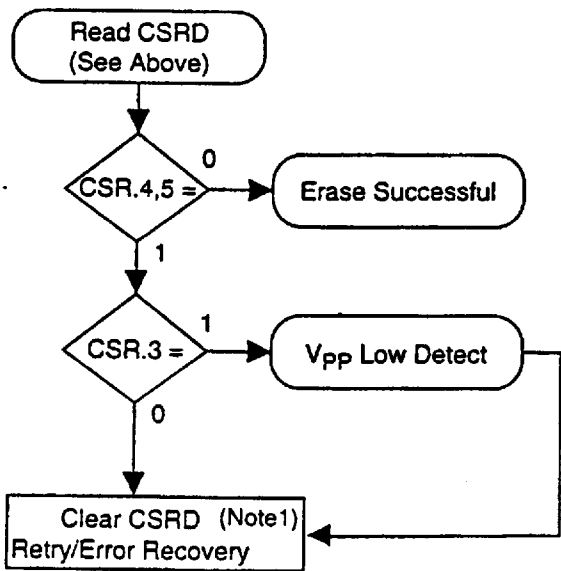

Bus Operation	Command	Comments
Standby		Check CSR.4,5 1 = Erase Error 0 = Erase Successful Both 1 = Command Sequence Error
Standby		Check CSR.3 1 = Vpp Low Detect 0 = Vpp OK

CSR.3,4,5 SHOULD be cleared, if set, before further attempts are initiated.

Note 1. If CSR.3 (VPPS) is set to "1", after clearing CSR.3/4/5,
 (1). Issue Reset WP command.
 (2). Retry Single Block Erase command,
 (3). Set WP command is issued, if necessary.

If CSR.3 (VPPS) is set to "0", after clearing CSR.3/4/5,
 (1). Retry Single Block Erase command.

If power is off or RP# is set low during erase operation,
 (1). Clear CSR.3/4/5 and issue Reset WP command,
 (2). Retry Single Block Erase command,
 (3). Set WP command is issued, if necessary.

Figure 5-2. Block Erase with Compatible Status Register

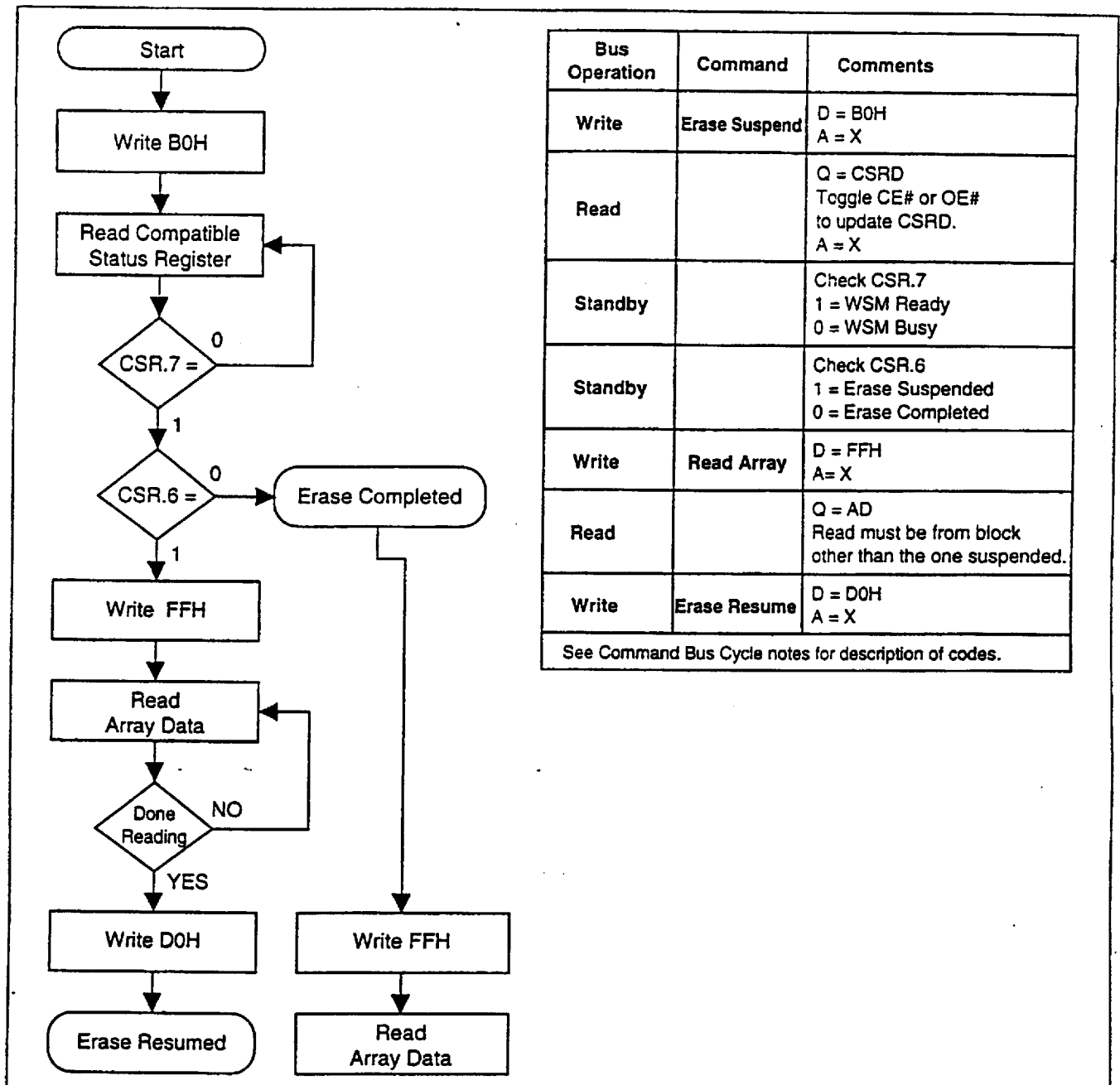

Figure 5-3. Erase Suspend to Read Array with Compatible Status Register

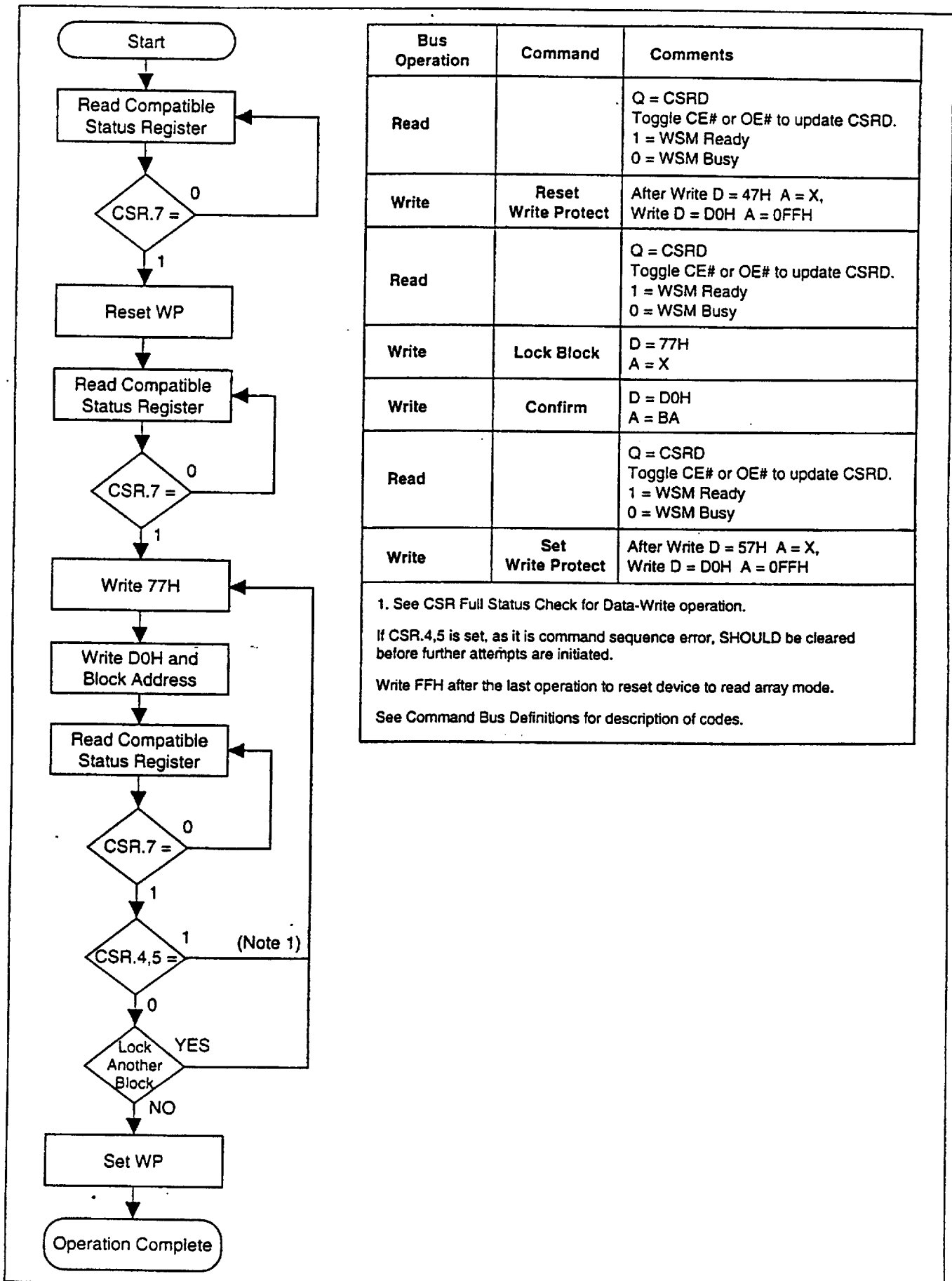

Figure 5-4. Block Locking Scheme

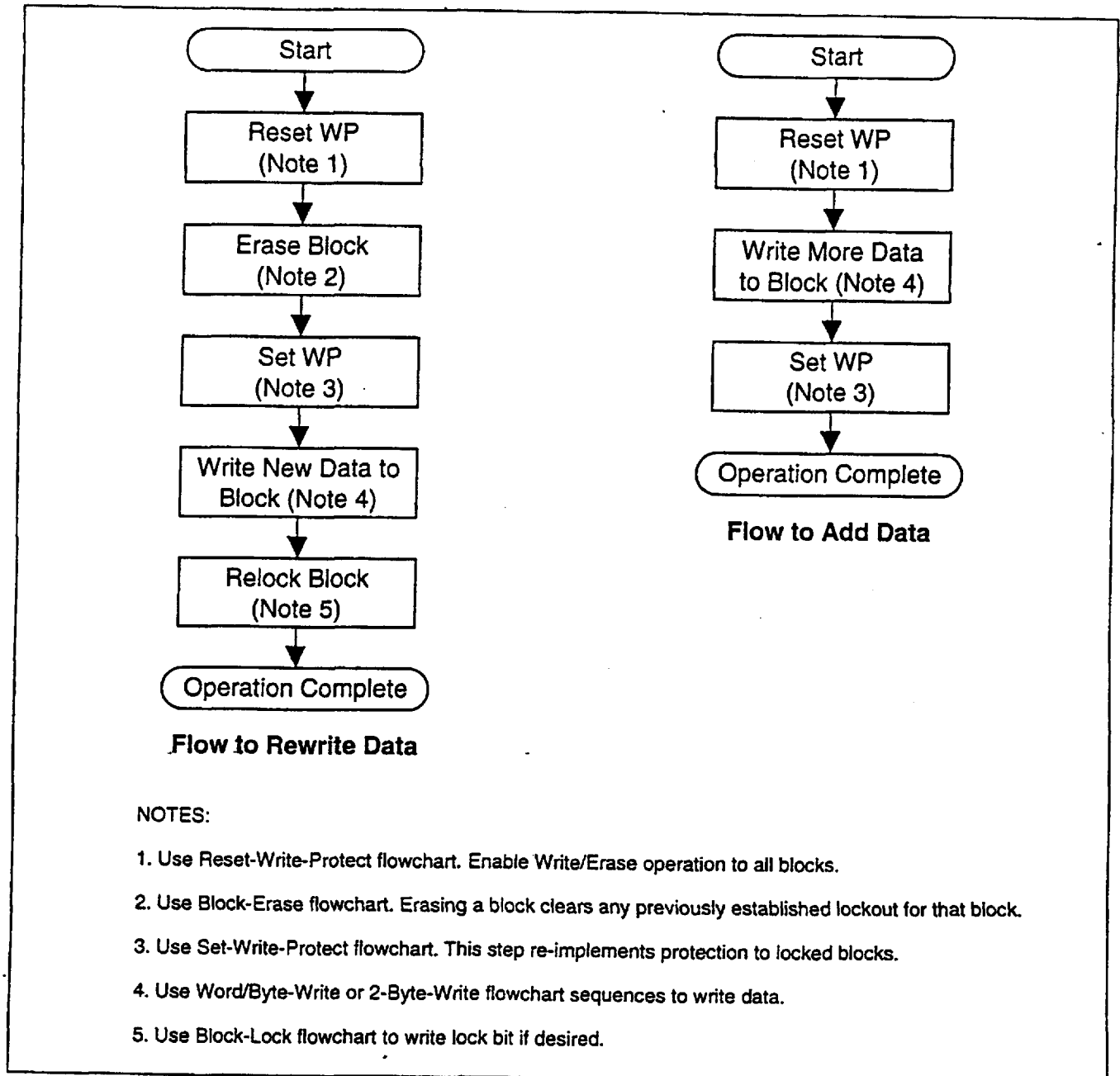

Figure 5-5. Updating Data in a Locked Block

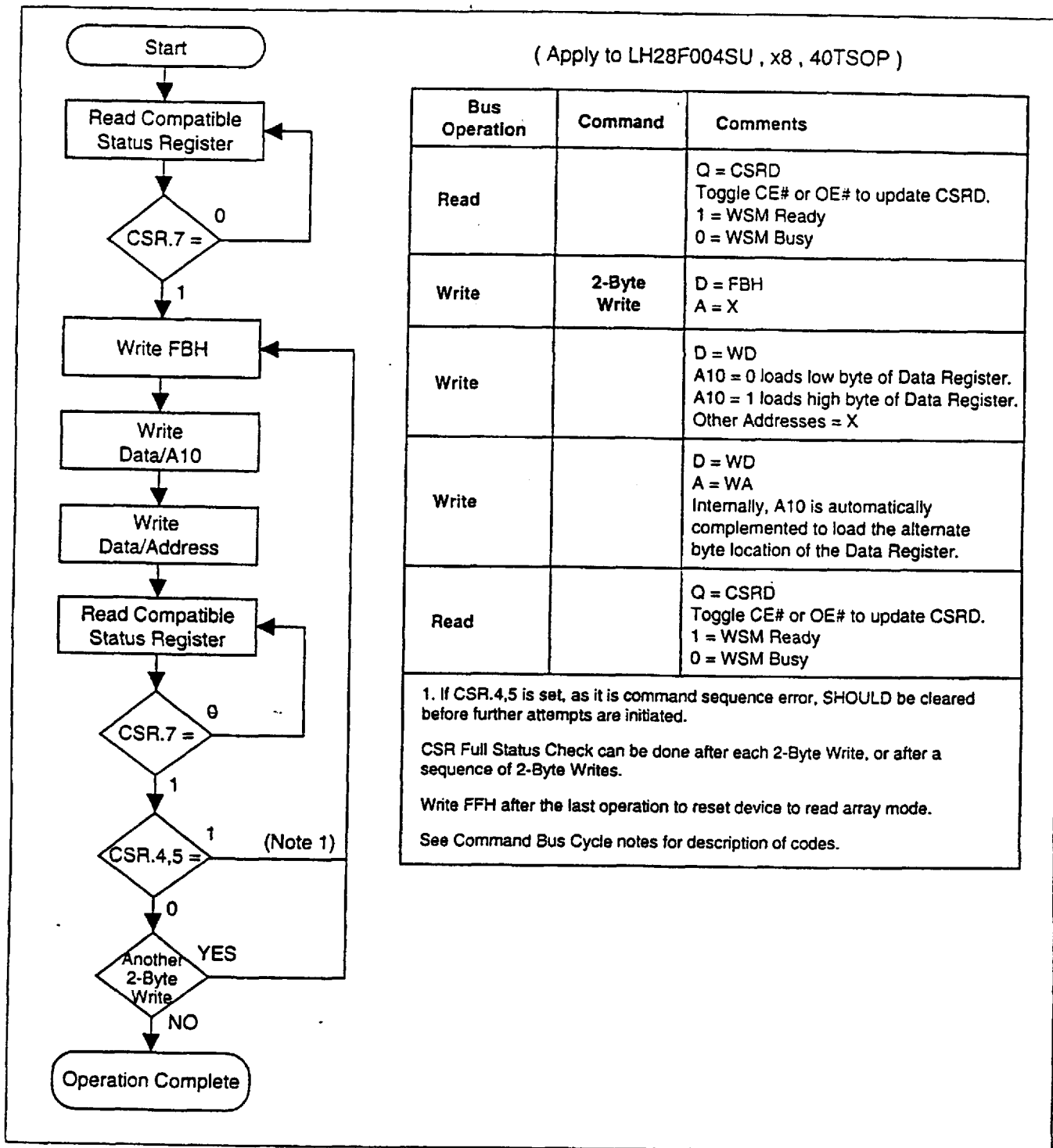
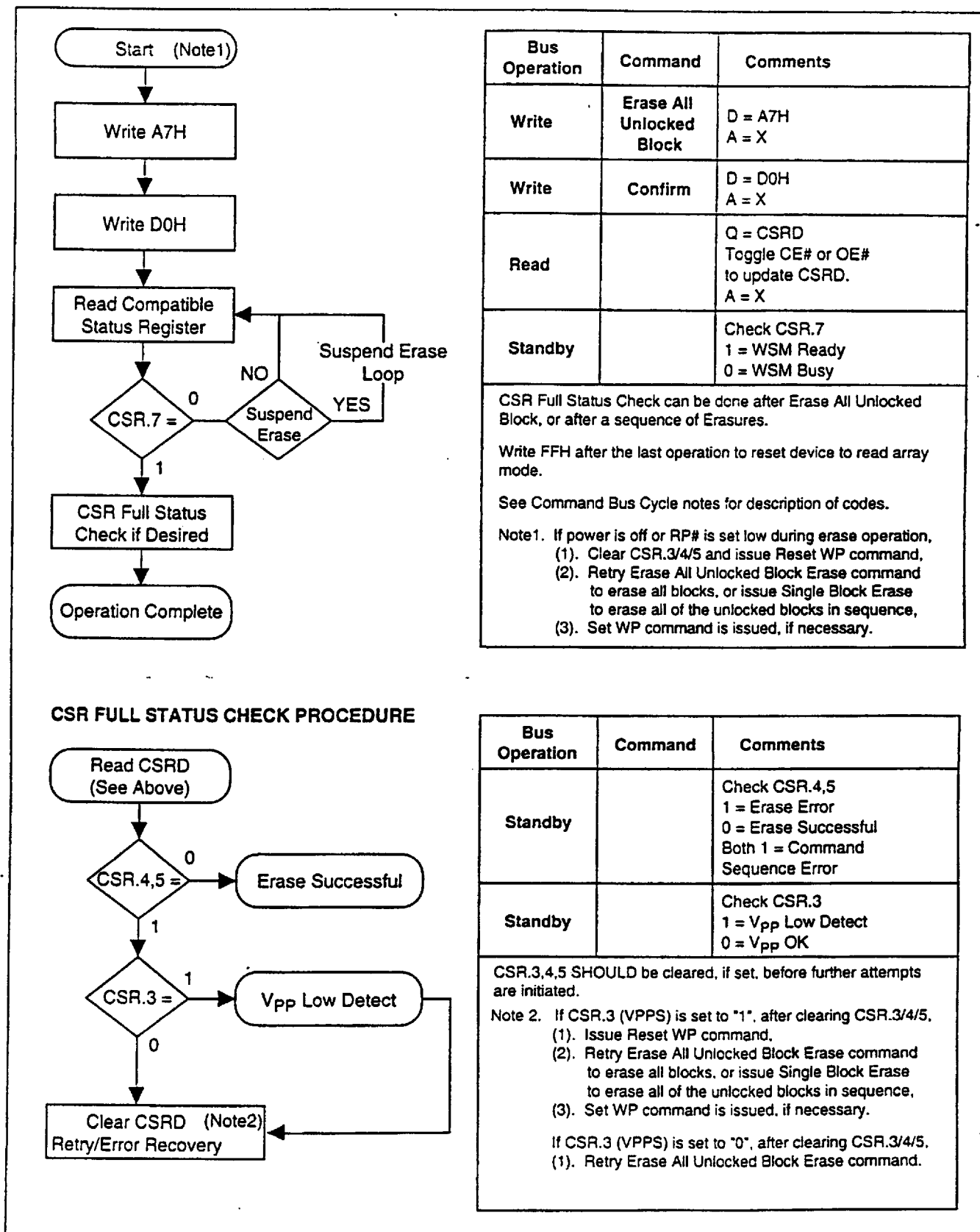

Figure 5-6. Two-Byte Serial Writes with Compatible Status Registers (LH28F004SU)



Bus Operation	Command	Comments
Write	Erase All Unlocked Block	D = A7H A = X
Write	Confirm	D = D0H A = X
Read		Q = CSR.D Toggle CE# or OE# to update CSR.D. A = X
Standby		Check CSR.7 1 = WSM Ready 0 = WSM Busy

CSR Full Status Check can be done after Erase All Unlocked Block, or after a sequence of Erasures.

Write FFH after the last operation to reset device to read array mode.

See Command Bus Cycle notes for description of codes.

Note1. If power is off or RP# is set low during erase operation,
 (1). Clear CSR.3/4/5 and issue Reset WP command,
 (2). Retry Erase All Unlocked Block Erase command to erase all blocks, or issue Single Block Erase to erase all of the unlocked blocks in sequence,
 (3). Set WP command is issued, if necessary.

Bus Operation	Command	Comments
Standby		Check CSR.4,5 1 = Erase Error 0 = Erase Successful Both 1 = Command Sequence Error
Standby		Check CSR.3 1 = Vpp Low Detect 0 = Vpp OK

CSR.3,4,5 SHOULD be cleared, if set, before further attempts are initiated.

Note 2. If CSR.3 (VPPS) is set to "1", after clearing CSR.3/4/5,
 (1). Issue Reset WP command,
 (2). Retry Erase All Unlocked Block Erase command to erase all blocks, or issue Single Block Erase to erase all of the unlocked blocks in sequence,
 (3). Set WP command is issued, if necessary.

If CSR.3 (VPPS) is set to "0", after clearing CSR.3/4/5,
 (1). Retry Erase All Unlocked Block Erase command.

Figure 5-7. Erase All Unlocked Blocks with Compatible Status Registers

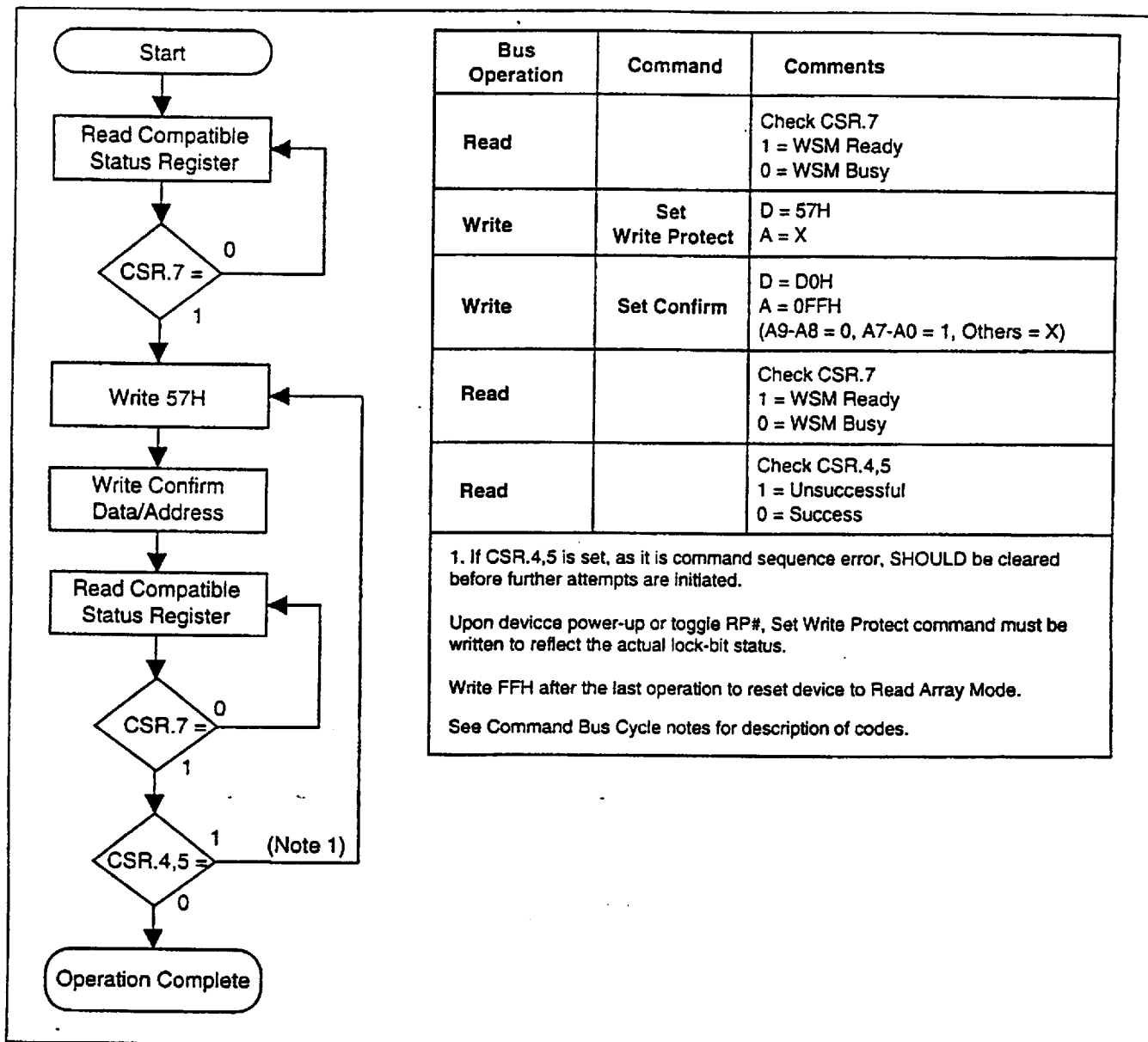

Figure 5-8. Set Write Protect

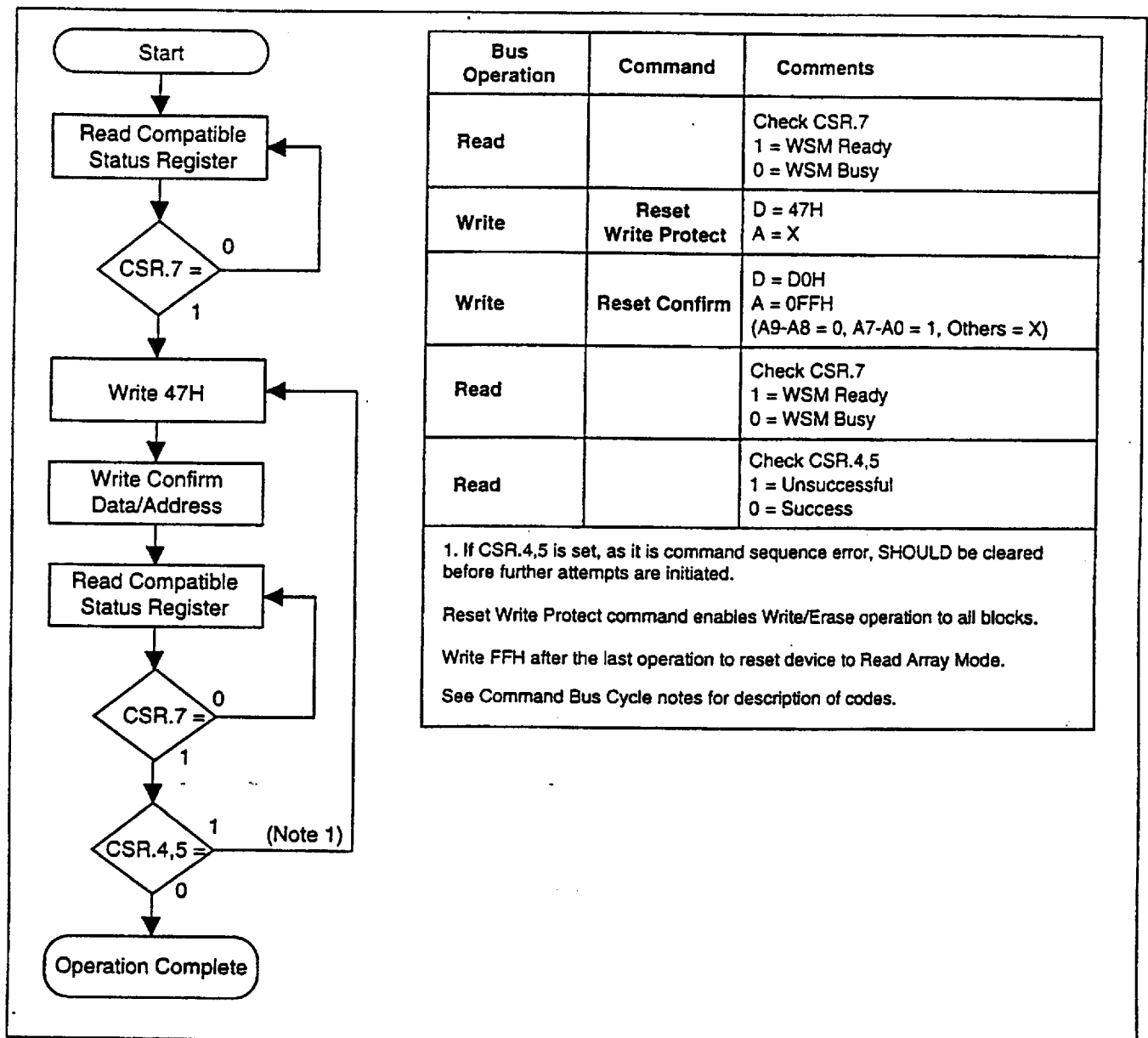

Figure 5-9. Reset Write Protect

6.0 ELECTRICAL SPECIFICATIONS⁽¹⁾Note: 1. V_{CC} supply range during read is 2.7 to 3.6V.**6.1 Absolute Maximum Ratings***

Temperature Under Bias - 20°C to + 85°C
 Storage Temperature - 65°C to + 125°C

**WARNING: Stressing the device beyond the "Absolute Maximum Ratings" may cause permanent damage. These are stress ratings only. Operation beyond the "Operating Conditions" is not recommended and extended exposure beyond the "Operating Conditions" may affect device reliability.*

V_{CC} = 3.3V ± 0.3V Systems

Symbol	Parameter	Notes	Min	Max	Units	Test Conditions
T _A	Operating Temperature, Commercial	1	- 20	85	°C	Ambient Temperature
V _{CC}	V _{CC} with Respect to GND	2	- 0.2	7.0	V	
V _{PP}	V _{PP} Supply Voltage with Respect to GND	2	- 0.2	7.0	V	
V	Voltage on any Pin (except V _{CC} , V _{PP}) with Respect to GND	2	- 0.5	V _{CC} + 0.5	V	
I	Current into any Non-Supply Pin			± 30	mA	
I _{OUT}	Output Short Circuit Current	3		100	mA	

NOTES:

1. Operating temperature is for commercial product defined by this specification.
2. Minimum DC voltage is - 0.5V on input/output pins. During transitions, this level may undershoot to - 2.0V for periods < 20 ns. Maximum DC voltage on input/output pins is V_{CC} + 0.5V which, during transitions, may overshoot to V_{CC} + 2.0V for periods < 20 ns.
3. Output shorted for no more than one second. No more than one output shorted at a time.

6.2 Capacitance

For a 3.3V System:

Symbol	Parameter	Note	Typ	Max	Units	Test Conditions
C _{IN}	Capacitance Looking into an Address/Control Pin	1	7	10	pF	T _A = 25°C, f = 1.0 MHz
	Capacitance Looking into an Address/Control Pin A10	1	9	12	pF	T _A = 25°C, f = 1.0 MHz
C _{OUT}	Capacitance Looking into an Output Pin	1	9	12	pF	T _A = 25°C, f = 1.0 MHz
C _{LOAD}	Load Capacitance Driven by Outputs for Timing Specifications	1		50	pF	For V _{CC} = 3.3V ± 0.3V
	Equivalent Testing Load Circuit V _{CC} ± 10%			2.5	ns	50Ω transmission line delay

NOTE:

1. Sampled, not 100% tested.

6.3 Timing Nomenclature

For 3.3V systems use 1.5V cross point definitions.

Each timing parameter consists of 5 characters. Some common examples are defined below:

t_{CE}	t_{ELQV}	time(t) from CE# (E) going low (L) to the outputs (Q) becoming valid (V)
t_{CE}	t_{GLOV}	time(t) from OE# (G) going low (L) to the outputs (Q) becoming valid (V)
t_{ACC}	t_{AVQV}	time(t) from address (A) valid (V) to the outputs (Q) becoming valid (V)
t_{AS}	t_{AVWH}	time(t) from address (A) valid (V) to WE# (W) going high (H)
t_{DH}	t_{WHDX}	time(t) from WE# (W) going high (H) to when the data (D) can become undefined (X)

	Pin Characters		Pin States
A	Address Inputs	H	High
D	Data Inputs	L	Low
Q	Data Outputs	V	Valid
E	CE# (Chip Enable)	X	Driven, but not necessarily valid
G	OE# (Output Enable)	Z	High Impedance
W	WE# (Write Enable)		
P	RP# (Deep Power-Down Pin)		
R	RY/BY# (Ready/Busy#)		
V	Any Voltage Level		
3V	V _{CC} at 3.0V Minimum		

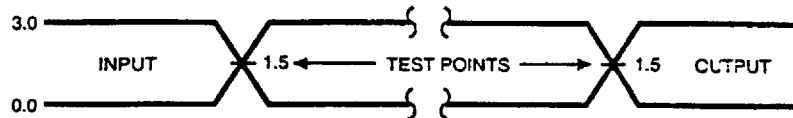

AC test inputs are driven at 3.0V for a Logic "1" and 0.0V for a Logic "0." Input timing begins, and output timing ends, at 1.5V. Input rise and fall times (10% to 90%) < 10 ns.

Figure 4. Transient Input/Output Reference Waveform ($V_{CC} = 3.3V$)

2.5 ns of 50 Ω Transmission Line

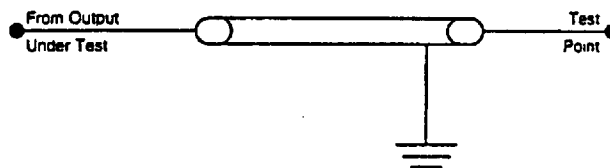

Total Capacitance = 50 pF

Figure 5. Transient Equivalent Testing Load Circuit ($V_{CC} = 3.3V$)

6.4 DC Characteristics

 $V_{CC} = 3.3V \pm 0.3V$, $T_A = -20^\circ C$ to $+85^\circ C$

Symbol	Parameter	Notes	Min	Typ	Max	Units	Test Conditions
I_{IL}	Input Load Current	1			± 1	μA	$V_{CC} = V_{CC} \text{ Max}$, $V_{IN} = V_{CC}$ or GND
I_{LO}	Output Leakage Current	1			± 10	μA	$V_{CC} = V_{CC} \text{ Max}$, $V_{IN} = V_{CC}$ or GND
I_{CCS}	V_{CC} Standby Current	1,4		4	15	μA	$V_{CC} = V_{CC} \text{ Max}$, $CE\#, RP\# = V_{CC} \pm 0.2V$
				0.3	4	mA	$V_{CC} = V_{CC} \text{ Max}$, $CE\#, RP\# = V_{IH}$
I_{CCD}	V_{CC} Deep Power-Down Current	1		0.2	8	μA	$RP\# = GND \pm 0.2V$
I_{CCR1}	V_{CC} Read Current	1,3,4			35	mA	$V_{CC} = V_{CC} \text{ Max}$, CMOS: $CE\# = GND \pm 0.2V$ Inputs = $GND \pm 0.2V$ or $V_{CC} \pm 0.2V$, TTL: $CE\# = V_{IL}$, Inputs = V_{IL} or V_{IH} , $f = 8 \text{ MHz}$, $I_{OUT} = 0 \text{ mA}$
I_{CCR2}	V_{CC} Read Current	1,3,4		9	20	mA	$V_{CC} = V_{CC} \text{ Max}$, CMOS: $CE\# = GND \pm 0.2V$, Inputs = $GND \pm 0.2V$ or $V_{CC} \pm 0.2V$, TTL: $CE\# = V_{IL}$, Inputs = V_{IL} or V_{IH} , $f = 4 \text{ MHz}$, $I_{OUT} = 0 \text{ mA}$
I_{CCW}	V_{CC} Write Current	1		8	16	mA	Byte/Two-Byte Serial Write in Progress
I_{CCE}	V_{CC} Block Erase Current	1		6	12	mA	Block Erase in Progress
I_{CCES}	V_{CC} Erase Suspend Current	1,2		3	6	mA	$CE\# = V_{IH}$ Block Erase Suspended
I_{PPS}	V_{PP} Standby Current	1			± 10	μA	$V_{PP} \leq V_{CC}$
I_{PPD}	V_{PP} Deep Power-Down Current	1		0.2	8	μA	$RP\# = GND \pm 0.2V$

DC Characteristics (Continued)

 $V_{CC} = 3.3V \pm 0.3V$, $T_A = -20^\circ C$ to $+85^\circ C$

Symbol	Parameter	Notes	Min	Typ	Max	Units	Test Conditions
I _{PPR}	V _{PP} Read Current	1			200	μA	V _{PP} > V _{CC}
I _{PPW}	V _{PP} Write Current	1		15	35	mA	V _{PP} = V _{PPH} , Byte/Two-Byte Serial Write in Progress
I _{PPE}	V _{PP} Erase Current	1		20	40	mA	V _{PP} = V _{PPH} , Block Erase in Progress
I _{PPES}	V _{PP} Erase Suspend Current	1			200	μA	V _{PP} = V _{PPH} , Block Erase Suspended
V _{IL}	Input Low Voltage	5	-0.3		0.8	V	
V _{IH}	Input High Voltage		2.0		V _{CC} + 0.3	V	
V _{OL}	Output Low Voltage				0.4	V	V _{CC} = V _{CC} Min and I _{OL} = 4 mA
V _{OH1}	Output High Voltage		2.4			V	I _{OH} = -2 mA V _{CC} = V _{CC} Min
V _{OH2}			V _{CC} - 0.2			V	I _{OH} = -100 μA V _{CC} = V _{CC} Min
V _{PPL}	V _{PP} during Normal Operations	6	0.0		5.5	V	
V _{PPH}	V _{PP} during Write/Erase Operations		4.5	5.0	5.5	V	
V _{LKO}	V _{CC} Erase/Write Lock Voltage		1.4			V	

NOTES:

- All currents are in RMS unless otherwise noted. Typical values at $V_{CC} = 3.3V$, $V_{PP} = 5.0V$, $T = 25^\circ C$. These currents are valid for all product versions (package and speeds).
- I_{CCES} is specified with the device de-selected. If the device is read while in erase suspend mode, current draw is the sum of I_{CCES} and I_{CCR}.
- Automatic Power Saving (APS) reduces I_{CCR} to less than 1 mA in Static operation.
- CMOS Inputs are either $V_{CC} \pm 0.2V$ or $GND \pm 0.2V$. TTL Inputs are either V_{IL} or V_{IH}.
- In $2.7V < V_{CC} < 3.0V$ operation, TTL-level input of RP# is V_L (Max.) = 0.6V.
- V_{PPL} in read is $V_{CC} - 0.2V < V_{PPL} < 5.5V$ or $GND < V_{PPL} < GND + 0.2V$.

6.5 AC Characteristics - Read Only Operations⁽¹⁾ $V_{CC} = 3.3V \pm 0.3V$, $T_A = -20^\circ C$ to $+85^\circ C$

Symbol	Parameter	Notes	Min	Max	Units
t _{AVAV}	Read Cycle Time		150		ns
t _{AVGL}	Address Setup to OE# Going Low	3	0		ns
t _{AVQV}	Address to Output Delay			150	ns
t _{ELQV}	CE# to Output Delay	2		150	ns
t _{PHQV}	RP# High to Output Delay			750	ns
t _{GLQV}	OE# to Output Delay	2		50	ns
t _{ELQX}	CE# to Output in Low Z	3	0		ns
t _{EHQZ}	CE# to Output in High Z	3		55	ns
t _{GLQX}	OE# to Output in Low Z	3	0		ns
t _{GHQZ}	OE# to Output in High Z	3		40	ns
t _{OH}	Output Hold from Address, CE# or OE# Change, Whichever Occurs First	3	0		ns

NOTES:

1. See AC Input/Output Reference Waveforms for timing measurements, Figure 4.
2. OE# may be delayed up to $t_{ELQV} - t_{GLQV}$ after the falling edge of CE# without impact on t_{ELQV} .
3. Sampled, not 100% tested.

AC Characteristics - Read Only Operations⁽¹⁾ (Continued) $V_{CC} = 2.85V \pm 0.15V$, $T_A = -20^{\circ}C$ to $+85^{\circ}C$

Symbol	Parameter	Notes	Min	Max	Units
t _{AVAV}	Read Cycle Time		190		ns
t _{AVGL}	Address Setup to OE# Going Low	3	0		ns
t _{AVQV}	Address to Output Delay			190	ns
t _{ELQV}	CE# to Output Delay	2		190	ns
t _{PHQV}	RP# High to Output Delay			900	ns
t _{GLQV}	OE# to Output Delay	2		65	ns
t _{ELQX}	CE# to Output in Low Z	3	0		ns
t _{EHQZ}	CE# to Output in High Z	3		70	ns
t _{GLQX}	OE# to Output in Low Z	3	0		ns
t _{GHQZ}	OE# to Output in High Z	3		55	ns
t _{OH}	Output Hold from Address, CE# or OE# Change, Whichever Occurs First	3	0		ns

NOTES:

1. See AC Input/Output Reference Waveforms for timing measurements, Figure 4.
2. OE# may be delayed up to $t_{ELQV} - t_{GLQV}$ after the falling edge of CE# without impact on t_{ELQV} .
3. Sampled, not 100% tested.

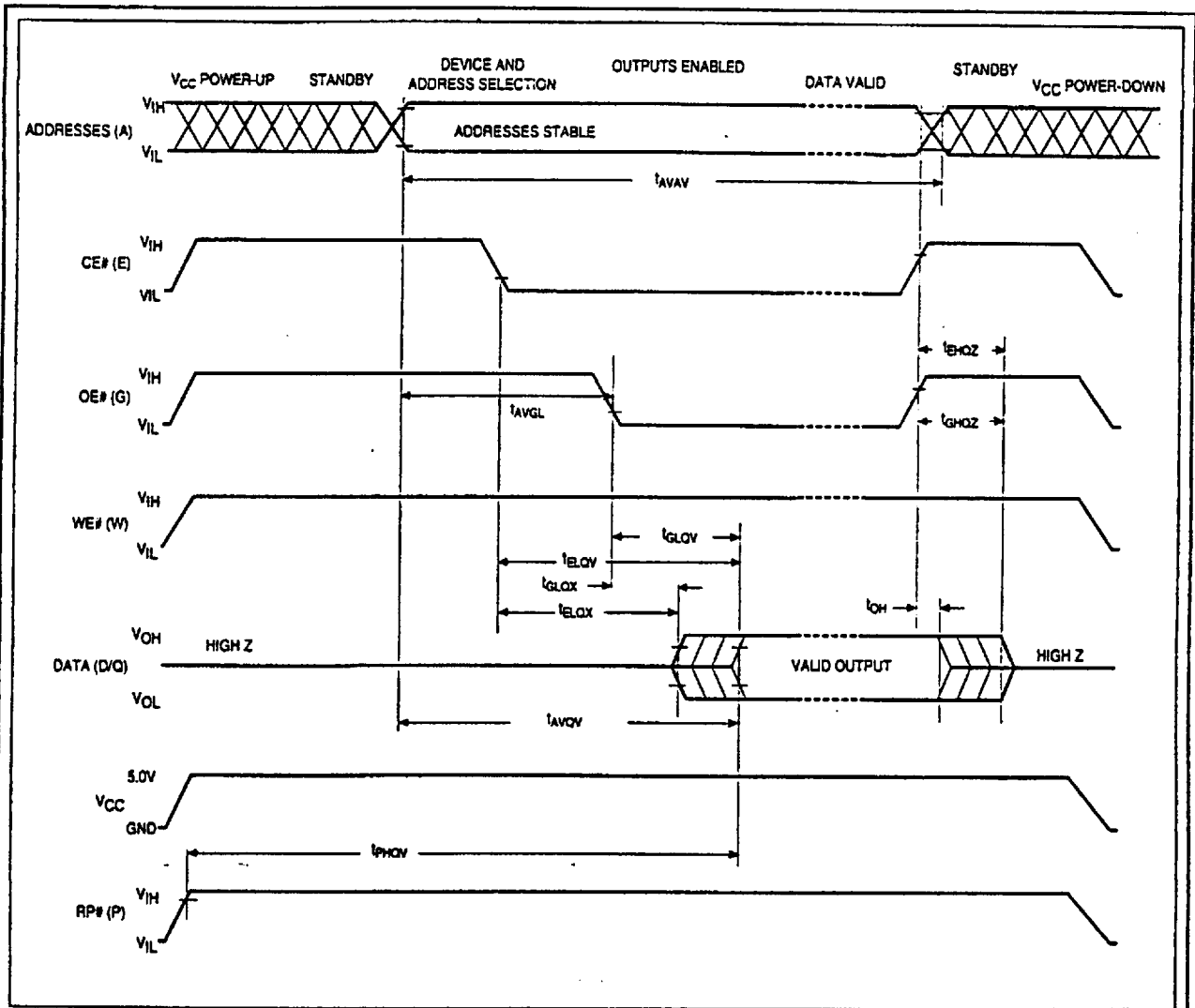
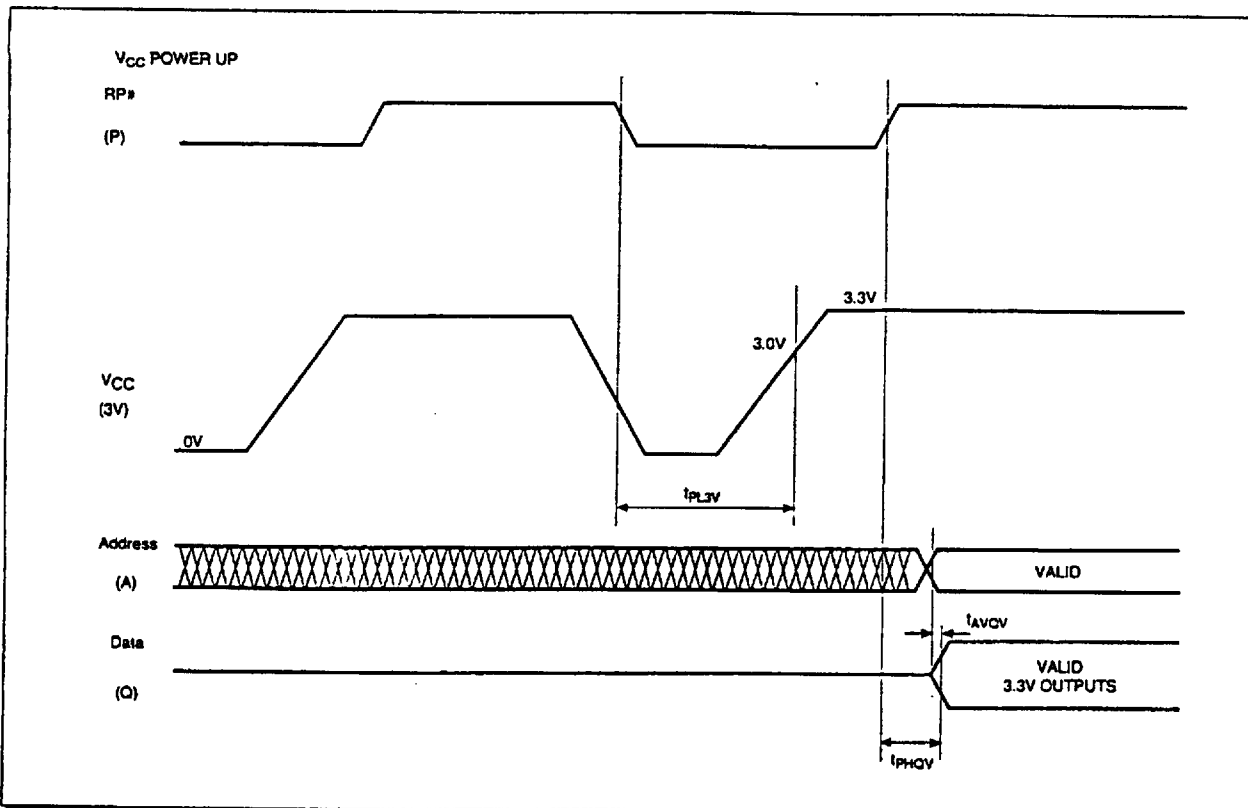

Figure 6. Read Timing Waveforms

6.6 Power-Up and Reset Timings

Figure 7. V_{CC} Power-Up and $RP\#$ Reset Waveforms

Symbol	Parameter	Note	Min	Max	Unit
t_{PL3V}	$RP\#$ Low to V_{CC} at 3.0V Minimum	1	0		μs
t_{AVQV}	Address Valid to Data Valid for $V_{CC} = 3.3V \pm 0.3V$	2		150	ns
t_{PHQV}	$RP\#$ High to Data Valid for $V_{CC} = 3.3V \pm 0.3V$	2		750	ns

NOTES:

$CE\#$ and $OE\#$ are switched low after Power-Up.

1. The power supply may start to switch concurrently with $RP\#$ going Low. $RP\#$ is required to stay low, until V_{CC} stays at recommended operating voltage.

2. The address access time and $RP\#$ high to data valid time are shown for 3.3V V_{CC} operation. Refer to the AC Characteristics Read Only Operations also.

6.7 AC Characteristics for WE# - Controlled Command Write Operations⁽¹⁾V_{CC} = 3.0 ± 0.3V, T_A = +15°C to +35°C

Symbol	Parameter	Notes	Min	Typ	Max	Unit
t _{AVAV}	Write Cycle Time		150			ns
t _{VPWH}	V _{PP} Setup to WE# Going High	3	100			ns
t _{PHEL}	RP# Setup to CE# Going Low		480			ns
t _{ELWL}	CE# Setup to WE# Going Low		10			ns
t _{AVWH}	Address Setup to WE# Going High	2,6	110			ns
t _{DVWH}	Data Setup to WE# Going High	2,6	110			ns
t _{WLWH}	WE# Pulse Width		110			ns
t _{WHDX}	Data Hold from WE# High	2	10			ns
t _{WHAX}	Address Hold from WE# High	2	10			ns
t _{WHEH}	CE# Hold from WE# High		10			ns
t _{WHWL}	WE# Pulse Width High		75			ns
t _{GHWL}	Read Recovery before Write		0			ns
t _{WHRL}	WE# High to RY/BY# Going Low				100	ns
t _{RHPL}	RP# Hold from Valid Status Register Data and RY/BY# High	3	0			ns
t _{PHWL}	RP# High Recovery to WE# Going Low		1			μs
t _{WHGL}	Write Recovery before Read		120			ns
t _{QVVL}	V _{PP} Hold from Valid Status Register Data and RY/BY# High		0			μs
t _{WHQV1}	Duration of Byte Write Operation	4,5	8	TBD		μs
t _{WHQV2}	Duration of Block Erase Operation	4	0.3			s

NOTES:

1. Read timing during write and erase are the same as for normal read.
2. Refer to command definition tables for valid address and data values.
3. Sampled, but not 100% tested.
4. Write/Erase durations are measured to valid Status Register (CSR) Data.
5. Byte write operations are typically performed with 1 Programming Pulse.
6. Address and Data are latched on the rising edge of WE# for all Command Write operations.

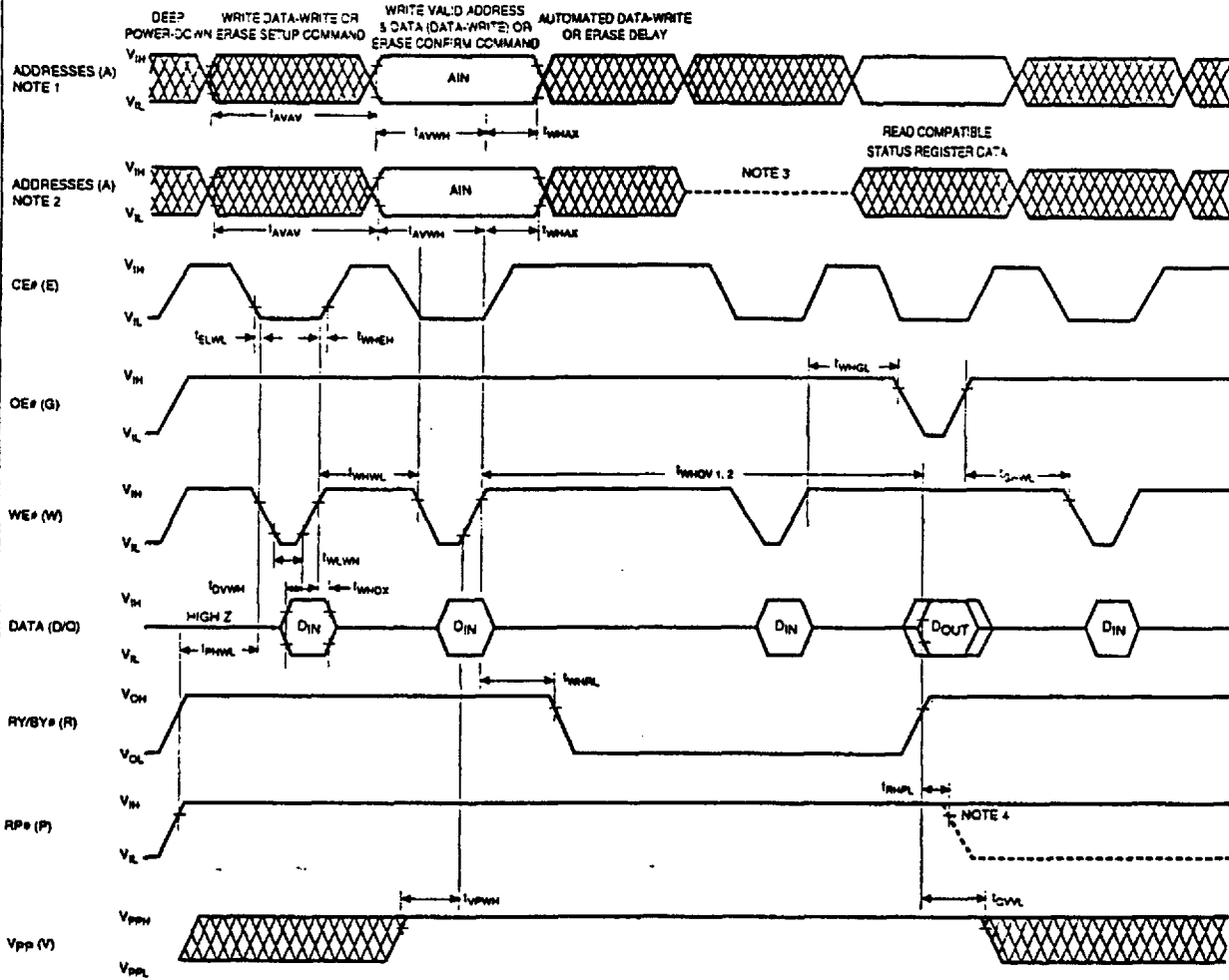
**NOTES:**

1. This address string depicts Data-Write/Erase cycles with corresponding verification via ESRD.
2. This address string depicts Data-Write/Erase cycles with corresponding verification via CSRD.
3. This cycle is invalid when using CSRD for verification during Data-Write/Erase operations.
4. RP# low transition is only to show t_{RPHL} ; not valid for above Read and Write cycles.

Figure 8. AC Waveforms for Command Write Operations

6.8 AC Characteristics for CE# - Controlled Command Write Operations⁽¹⁾

$V_{CC} = 3.0 \pm 0.3V$, $T_A = -15^{\circ}C$ to $+35^{\circ}C$

Symbol	Parameter	Notes	Min	Typ	Max	Unit
tAVAV	Write Cycle Time		150			ns
tPHWL	RP# Setup to WE# Going Low	3	480			ns
tVPEH	VPP Setup to CE# Going High	3	100			ns
tWLEL	WE# Setup to CE# Going Low		0			ns
tAVEH	Address Setup to CE# Going High	2,6	110			ns
tOVEH	Data Setup to CE# Going High	2,6	110			ns
tELEH	CE# Pulse Width		110			ns
tEHDX	Data Hold from CE# High	2	10			ns
tEHAX	Address Hold from CE# High	2	10			ns
tEHWL	WE# Hold from CE# High		10			ns
tEHEL	CE# Pulse Width High		75			ns
tGHLE	Read Recovery before Write		0			ns
tEURL	CE# High to RY/BY# Going Low				100	ns
tRHPL	RP# Hold from Valid Status Register Data and RY/BY# High	3	0			ns
tPHLE	RP# High Recovery to CE# Going Low		1			μs
tEHGL	Write Recovery before Read		120			ns
tQVVL	VPP Hold from Valid Status Register Data and RY/BY# High		0			μs
tEHQV1	Duration of Byte Write Operation	4,5	8	TBD		μs
tEHQV2	Duration of Block Erase Operation	4	0.3			s

NOTES:

1. Read timing during write and erase are the same as for normal read.
2. Refer to command definition tables for valid address and data values.
3. Sampled, but not 100% tested.
4. Write/Erase durations are measured to valid Status Register (CSR) Data.
5. Byte write operations are typically performed with 1 Programming Pulse.
6. Address and Data are latched on the rising edge of CE# for all Command Write Operations.

6.9 Erase and Byte Write Performance

$V_{CC} = 3.0 \pm 0.3V$, $T_A = +15^\circ C$ to $+35^\circ C$

Symbol	Parameter	Notes	Min	Typ ⁽¹⁾	Max	Units	Test Conditions
t _{WHRH1}	Byte Write Time	2		TBD		μs	
t _{WHRH2}	Two-Byte Serial Write Time	2		TBD		μs	
t _{WHRH3}	16KB Block Write Time	2			2.0	s	Byte Write Mode
t _{WHRH4}	16KB Block Write Time	2			1.8	s	Two-Byte Serial Write Mode
	Block Erase Time (16KB)	2			TBD	s	
	Full Chip Erase Time	2,3			TBD	s	

NOTES:

1. 25°C, $V_{PP} = 5.0V$.
2. Excludes System-Level Overhead.
3. Depends on the number of protected blocks.
4. Upon delivery from SHARP, the LH28F004SUB-Z9 has all 512k X 8 in the "1", or high state.