

PRELIMINARY DATA SHEET

# HAL 800 Programmable Linear Hall Effect Sensor

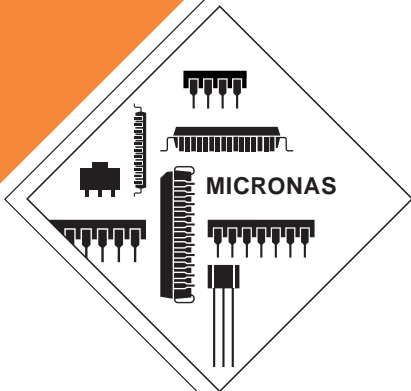

Edition Oct. 20, 1999  
6251-441-1DS

 MICRONAS

## Contents

Page	Section	Title
<b>3</b>	<b>1.</b>	<b>Introduction</b>
3	1.1.	Major Applications
3	1.2.	Features
4	1.3.	Marking Code
4	1.4.	Operating Junction Temperature Range ( $T_J$ )
4	1.5.	Hall Sensor Package Codes
4	1.6.	Solderability
4	1.7.	Pin Connections and Short Descriptions
<b>5</b>	<b>2.</b>	<b>Functional Description</b>
5	2.1.	General Function
7	2.2.	Digital Signal Processing and EEPROM
9	2.3.	Calibration Procedure
9	2.3.1.	General Procedure
10	2.3.2.	Calibration of Angle Sensor
<b>11</b>	<b>3.</b>	<b>Specifications</b>
11	3.1.	Outline Dimensions
11	3.2.	Dimensions of Sensitive Area
11	3.3.	Position of Sensitive Area
12	3.4.	Absolute Maximum Ratings
12	3.5.	Recommended Operating Conditions
13	3.6.	Electrical Characteristics
14	3.7.	Magnetic Characteristics
14	3.8.	Typical Characteristics
<b>17</b>	<b>4.</b>	<b>Application Notes</b>
17	4.1.	Application Circuit
17	4.2.	Temperature Compensation
18	4.3.	Ambient Temperature
18	4.4.	EMC and ESD
<b>19</b>	<b>5.</b>	<b>Programming of the Sensor</b>
19	5.1.	Definition of Programming Pulses
19	5.2.	Definition of the Telegram
21	5.3.	Telegram Codes
22	5.4.	Number Formats
23	5.5.	Register Information
23	5.6.	Programming Information
<b>24</b>	<b>6.</b>	<b>Data Sheet History</b>

## Programmable Linear Hall Effect Sensor

### 1. Introduction

The HAL 800 is an universal magnetic field sensor with a linear output based on the Hall effect. The IC is designed and produced in sub-micron CMOS technology and can be used for angle or distance measurements if combined with a rotating or moving magnet. The major characteristics like magnetic field range, sensitivity, output quiescent voltage (output voltage at  $B = 0$  mT), and output voltage range are programmable in a non-volatile memory. The sensor has a ratio-metric output characteristic, which means that the output voltage is proportional to the magnetic flux and the supply voltage.

The HAL 800 features a temperature compensated Hall plate with chopped offset compensation, an A/D converter, digital signal processing, a D/A converter with output driver, an EEPROM memory with redundancy and lock function for the calibration data, a serial interface for programming the EEPROM, and protection devices at all pins. The internal digital signal processing is of great benefit because analog offsets, temperature shifts, and mechanical stress do not degrade the sensor accuracy.

The HAL 800 is programmable by modulating the supply voltage. No additional programming pin is needed. The easy programmability allows a 2-point calibration by adjusting the output voltage directly to the input signal (like mechanical angle, distance or current). An individual adjustment of each sensor during the customers manufacturing process is possible. With this calibration procedure the tolerances of the sensor, the magnet, and the mechanical positioning can be compensated in the final assembly.

In addition, the temperature compensation of the Hall IC can be fit to all common magnetic materials by programming first and second order temperature coefficients of the Hall sensor sensitivity. This enables an operation over the full temperature range with high accuracy.

The calculation of the individual sensor characteristics and the programming of the EEPROM memory can easily be done with a PC and the application kit from Micronas. The HAL 800 eases logistic because its characteristics can be programmed in a wide range. Therefore, one Hall IC type can be used for various applications.

The sensor is designed for hostile industrial and automotive applications and operates with typically 5 V supply voltage in the ambient temperature range from  $-40$  °C up to  $150$  °C.

The HAL 800 is available in the very small leaded package TO-92UT.

### 1.1. Major Applications

Due to the sensor's versatile programming characteristics, the HAL 800 is the optimal system solution for applications such as:

- contactless potentiometers,
- rotary position measurement,
- linear position detection,
- magnetic field and current measurement.

### 1.2. Features

- high precision linear Hall effect sensor with ratiometric output
- multiple programmable magnetic characteristics with non-volatile memory
- digital signal processing
- temperature characteristics programmable for matching all common magnetic materials
- programmable clamping voltages
- programming with a modulation of the supply voltage
- lock function and redundancy for EEPROM memory
- operates from  $-40$  °C up to  $150$  °C ambient temperature
- operates from 4.5 V up to 5.5 V supply voltage
- operates with static magnetic fields and dynamic magnetic fields up to 2 kHz
- chopped offset compensation
- overvoltage and reverse-voltage protection at all pins
- magnetic characteristics extremely robust against mechanical stress
- short-circuit protected push-pull output
- EMC optimized design

## 1.3. Marking Code

The HAL 800 has a marking on the package surface (branded side). This marking includes the name of the sensor and the temperature range.

Type	Temperature Range			
	A	K	E	C
HAL 800	800A	800K	800E	800C

## 1.4. Operating Junction Temperature Range ( $T_J$ )

A:  $T_J = -40\text{ °C}$  to  $+170\text{ °C}$

K:  $T_J = -40\text{ °C}$  to  $+140\text{ °C}$

E:  $T_J = -40\text{ °C}$  to  $+100\text{ °C}$

C:  $T_J = 0\text{ °C}$  to  $+100\text{ °C}$

The Hall sensors from Micronas are specified to the chip temperature (junction temperature  $T_J$ ).

The relationship between ambient temperature ( $T_A$ ) and junction temperature is explained in Section 4.3. on page 18.

## 1.5. Hall Sensor Package Codes

HALXXXPA-T

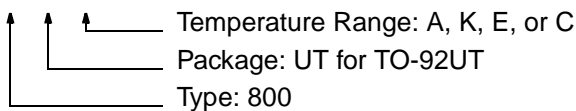

Example: **HAL800UT-A**

- Type: 800
- Package: TO-92UT
- Temperature Range:  $T_J = -40\text{ °C}$  to  $+170\text{ °C}$

Hall sensors are available in a wide variety of packaging versions and quantities. For more detailed information, please refer to the brochure: "Ordering Codes for Hall Sensors".

## 1.6. Solderability

Package TO-92UT: according to IEC68-2-58

During soldering reflow processing and manual reworking, a component body temperature of  $260\text{ °C}$  should not be exceeded.

Components stored in the original packaging should provide a shelf life of at least 12 months, starting from the date code printed on the labels, even in environments as extreme as  $40\text{ °C}$  and 90% relative humidity.

## 1.7. Pin Connections and Short Descriptions

Pin No.	Pin Name	Type	Short Description
1	$V_{DD}$	IN	Supply Voltage and Programming Pin
2	GND		Ground
3	OUT	OUT	Push Pull Output

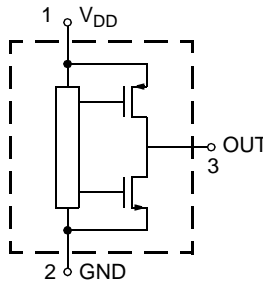

**Fig. 1-1:** Pin configuration

## 2. Functional Description

### 2.1. General Function

The HAL 800 is a monolithic integrated circuit which provides an output voltage proportional to the magnetic flux through the Hall plate and proportional to the supply voltage.

The external magnetic field component perpendicular to the branded side of the package generates a Hall voltage. This voltage is converted to a digital value, processed in the Digital Signal Processing Unit (DSP) according to the EEPROM programming, converted to an analog voltage with ratiometric behavior, and stabilized by a push-pull output transistor stage. The function and the parameters for the DSP are detailed explained in Section 2.2. on page 7.

The setting of the LOCK register disables the programming of the EEPROM memory for all time. This register cannot be reset.

As long as the LOCK register is not set, the output characteristic can be adjusted by modifying the EEPROM registers. The IC is addressed by modulating the supply voltage (see Fig. 2-1). In the supply voltage range from 4.5 V up to 5.5 V, the sensor gener-

ates an analog output voltage. After detecting a command, the sensor reads or writes the memory and answers with a digital signal on the output pin. The analog output is switched off during the communication.

Internal temperature compensation circuitry and the chopped offset compensation enables operation over the full temperature range with minimal changes in accuracy and high offset stability. The circuitry also rejects offset shifts due to mechanical stress from the package. The non-volatile memory is equipped with redundant EEPROM cells. In addition, the sensor IC is equipped with devices for overvoltage and reverse voltage protection at all pins.

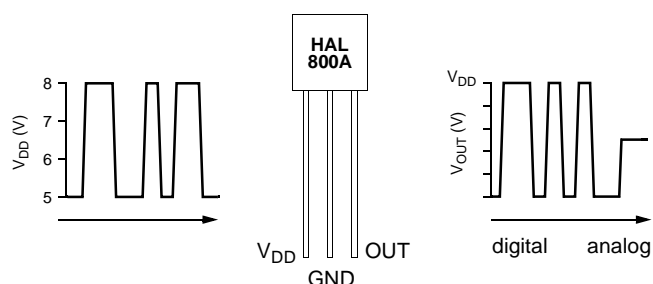

Fig. 2-1: Programming with  $V_{DD}$  modulation

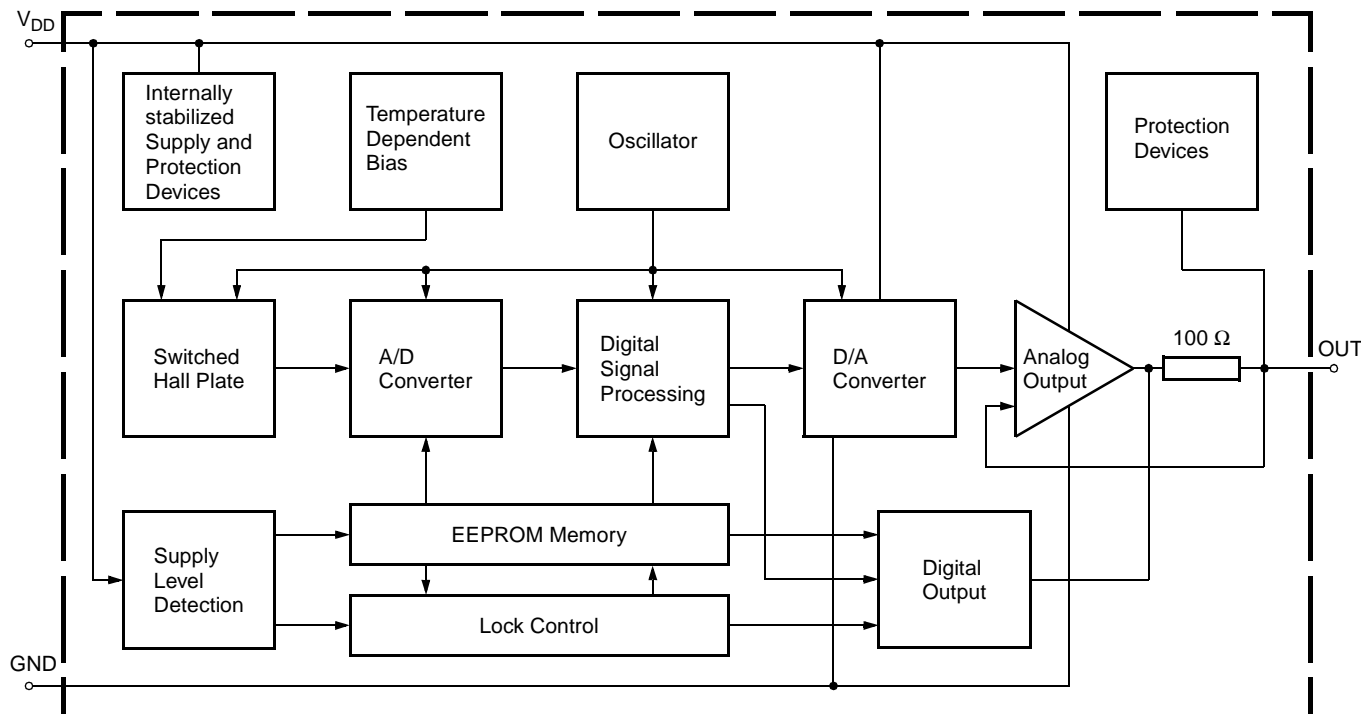

Fig. 2-2: HAL800 block diagram

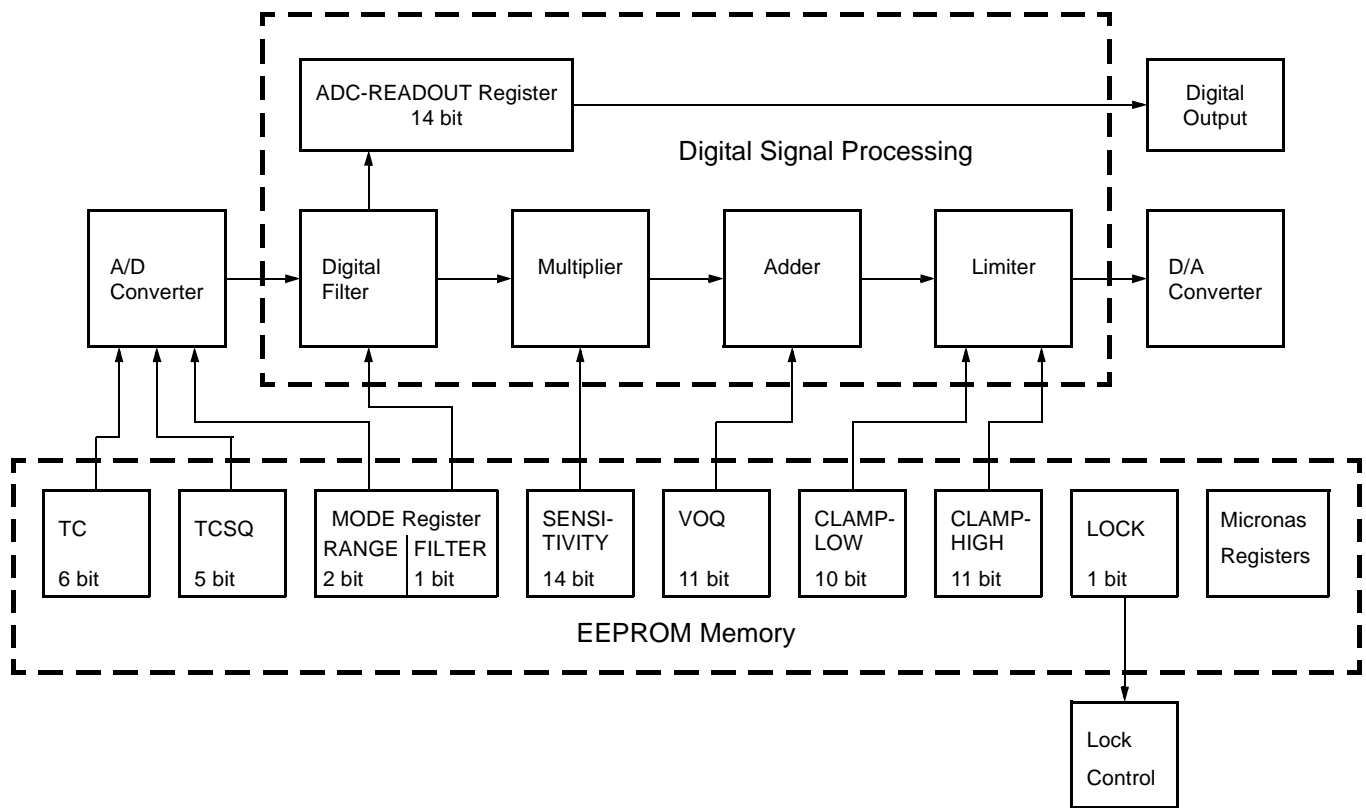
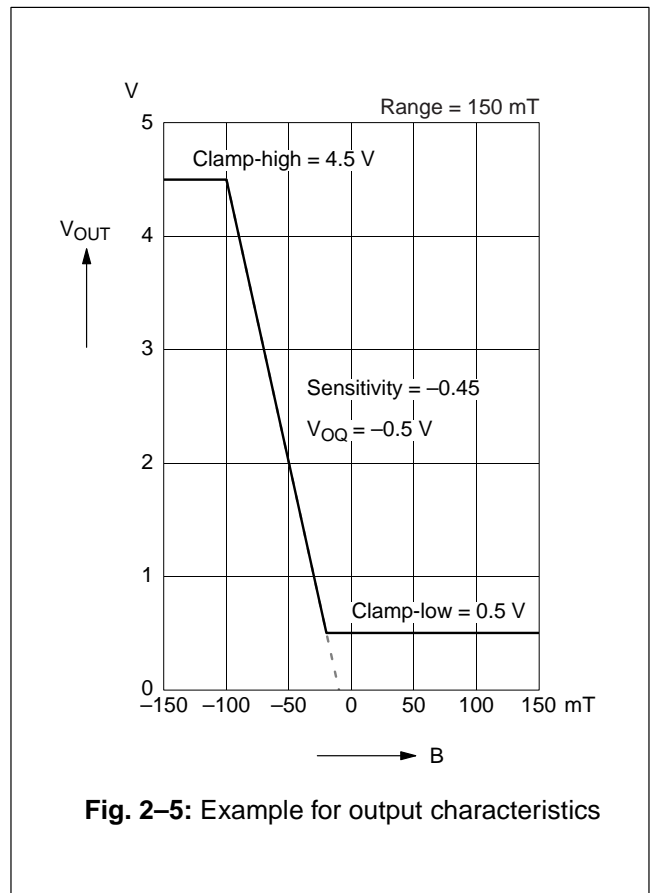
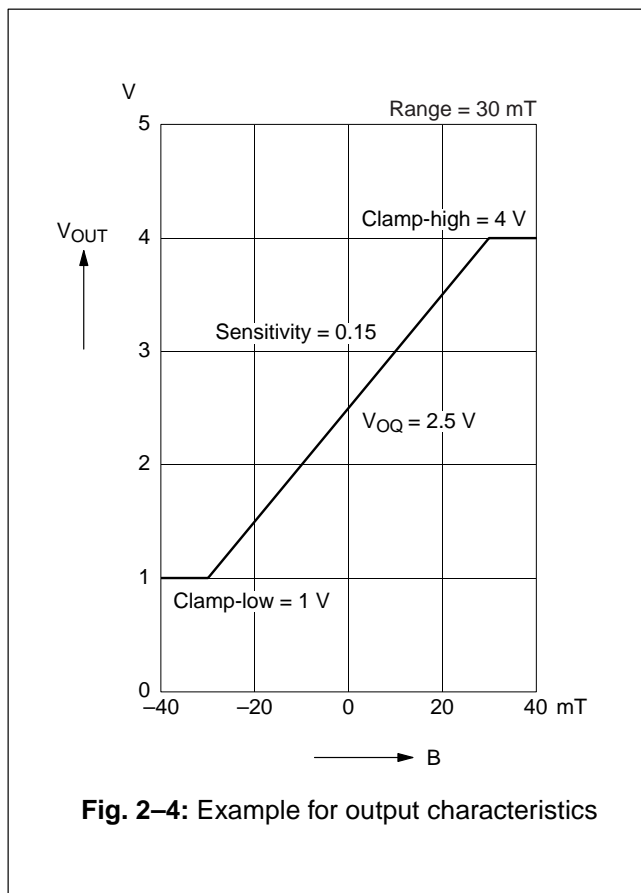

Fig. 2-3: Details of EEPROM and Digital Signal Processing



## 2.2. Digital Signal Processing and EEPROM

The DSP is the major part of this sensor and performs the signal conditioning. The parameters for the DSP are stored in the EEPROM registers. The details are shown in Fig. 2–3.

### Terminology:

SENSITIVITY: name of the register or register value

Sensitivity: name of the parameter

The EEPROM registers consist of three groups:

Group 1 contains the registers for the adaption of the sensor to the magnetic system:

MODE for selecting the magnetic field range and filter frequency, TC and TCSQ for temperature characteristics of the magnetic sensitivity.

Group 2 contains the registers for defining the output characteristics: SENSITIVITY, VOQ, CLAMP-LOW, and CLAMP-HIGH. The output characteristic of the sensor is defined by these 4 parameters (see Fig. 2–4 and Fig. 2–5 for examples).

- The parameter  $V_{OQ}$  (Output Quiescent Voltage) corresponds to the output voltage at  $B = 0$  mT.
- The parameter Sensitivity is defined as:

$$Sensitivity = \frac{\Delta V_{OUT}}{\Delta B}$$

- The output voltage can be calculated as:

$$V_{OUT} \sim Sensitivity \times B + V_{OQ}$$

The output voltage range can be clamped by setting the registers CLAMP-LOW and CLAMP-HIGH in order to enable failure detection (such as short-circuits to  $V_{DD}$  or GND).

Group 3 contains the Micronas registers and LOCK for the locking of all registers. The Micronas registers are programmed and locked during production and are read-only for the customer. These registers are used for oscillator frequency trimming, A/D converter offset compensation, and several other special settings.

The ADC converts positive or negative Hall voltages (operates with magnetic north and south poles at the branded side of the package) in a digital value. This signal is filtered in the Digital Filter and is readable in the ADC-READOUT register as long as the LOCK bit is not set.

**Note:** The ADC-READOUT values and the resolution of the system depends on the filter frequency. Positive values accord to a magnetic north pole on the branded side of the package. Fig. 2–6 and Fig. 2–7 show typical ADC-READOUT values for the different magnetic field ranges and filter frequencies.

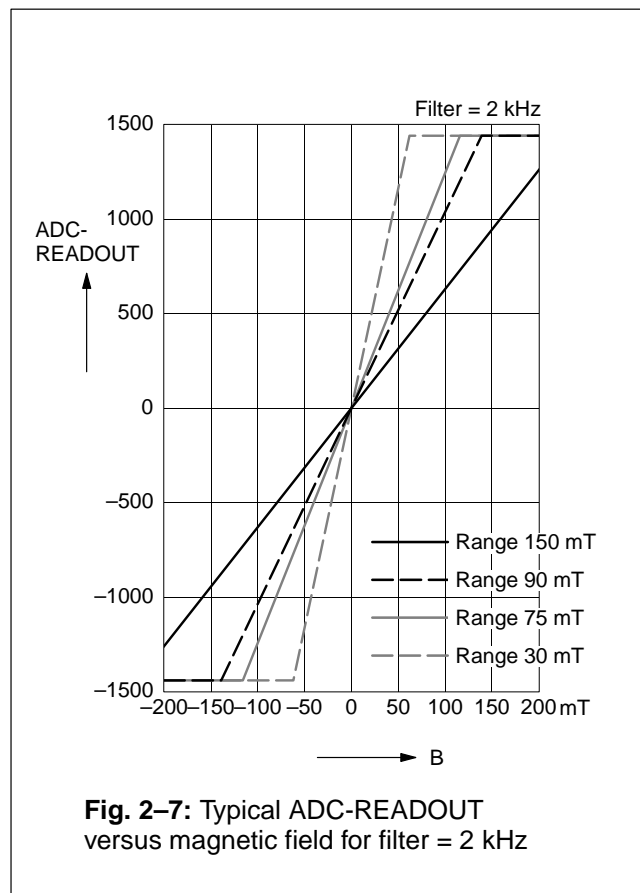
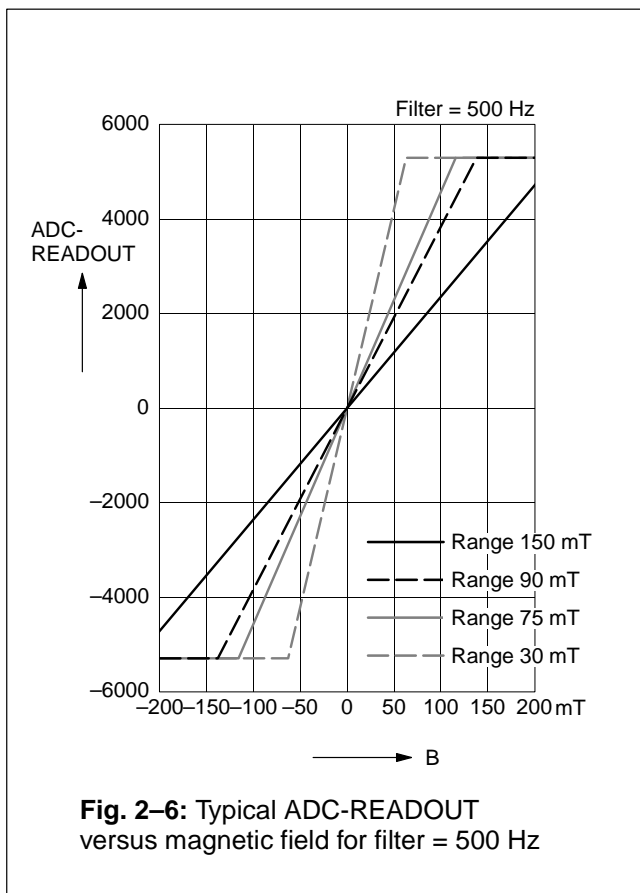

## Range

The RANGE bits are the two lowest bits of the MODE register; they define the magnetic field range of the A/D converter.

RANGE	Magnetic Field Range
0	-30 mT...30 mT
1	-75 mT...75 mT
2	-90 mT...90 mT
3	-150 mT...150 mT

## Filter

The FILTER bit is the highest bit of the MODE register; it defines the -3 dB frequency of the digital low pass filter

FILTER	-3 dB Frequency
0	2 kHz
1	500 Hz

## TC and TCSQ

The temperature dependence of the magnetic sensitivity can be adapted to different magnetic materials in order to compensate for the change of the magnetic strength with temperature. The adaption is done by programming the TC (Temperature Coefficient) and the TCSQ registers (Quadratic Temperature Coefficient). Thereby, the slope and the curvature of the magnetic sensitivity can be matched to the magnet and the sensor assembly. As a result, the output voltage characteristic can be fixed over the full temperature range. The sensor can compensate for linear temperature coefficients in the range from about -2900 ppm/K up to 700 ppm/K and quadratic coefficients from about -5 ppm/K<sup>2</sup> to 5 ppm/K<sup>2</sup>. Please refer to Section 4.2. on page 17 for the recommended settings for different linear temperature coefficients.

## Sensitivity

The SENSITIVITY register contains the parameter for the Multiplier in the DSP. The Sensitivity is programmable between -4 and 4. For  $V_{DD} = 5\text{ V}$  the register can be changed in steps of 0.00049. Sensitivity = 1 corresponds to an increase of the output voltage by  $V_{DD}$  if the ADC-READOUT increases by 2048.

For all calculations, the digital value from the magnetic field of the A/D converter is used. This digital information is readable from the ADC-READOUT register.

$$\text{Sensitivity} = \frac{\Delta V_{OUT} * 2048}{\Delta \text{ADC-READOUT} * V_{DD}}$$

## VOQ

The VOQ register contains the parameter for the Adder in the DSP.  $V_{OQ}$  is the output voltage without external magnetic field ( $B = 0\text{ mT}$ ) and programmable from  $-V_{DD}$  up to  $V_{DD}$ . For  $V_{DD} = 5\text{ V}$  the register can be changed in steps of 4.9 mV.

**Note:** If  $V_{OQ}$  is programmed to a negative voltage, the maximum output voltage is limited to:

$$V_{OUTmax} = V_{OQ} + V_{DD}$$

For calibration in the system environment, a 2-point adjustment procedure (see Section 2.3.) is recommended. The suitable Sensitivity and  $V_{OQ}$  values for each sensor can be calculated individually by this procedure.

## Clamping Voltage

The output voltage range can be clamped in order to detect failures like shorts to  $V_{DD}$  or GND.

The CLAMP-LOW register contains the parameter for the lower limit. The lower clamping voltage is programmable between 0 V and  $V_{DD}/2$ . For  $V_{DD} = 5\text{ V}$  the register can be changed in steps of 2.44 mV.

The CLAMP-HIGH register contains the parameter for the higher limit. The higher clamping voltage is programmable between 0 V and  $V_{DD}$ . For  $V_{DD} = 5\text{ V}$  in steps of 2.44 mV.

## LOCK

By setting this 1-bit register, all registers will be locked, and the sensor will no longer respond to any supply voltage modulation.

**Warning:** This register cannot be reset!

## ADC-READOUT

This 14-bit register delivers the actual digital value of the applied magnetic field before the signal processing. This register can be read out and is the basis for the calibration procedure of the sensor in the system environment.



## 2.3. Calibration Procedure

### 2.3.1. General Procedure

For calibration in the system environment, the application kit from Micronas is recommended. It contains the hardware for the generation of the serial telegram for programming and the corresponding software for the input of the register values.

In this section, programming of the sensor with this programming tool is explained. Please refer to Section 5. on page 19 for information about programming without this tool.

For the individual calibration of each sensor in the customer application, a two point adjustment is recommended (see Fig. 2–8 for an example). When using the application kit, the calibration can be done in three steps:

#### Step 1: Input of the registers which need not be adjusted individually

The magnetic circuit, the magnetic material with its temperature characteristics, the filter frequency, and low and high clamping voltage are given for this application.

Therefore, the values of the following registers should be identical for all sensors of the customer application.

- FILTER  
(according to the maximum signal frequency)
- RANGE  
(according to the maximum magnetic field at the sensor position)
- TC and TCSQ  
(depends on the material of the magnet and the other temperature dependencies of the application)
- CLAMP-LOW and CLAMP-HIGH  
(according to the application requirements)

Write the appropriate settings into the HAL 800 registers.

After writing, the information is stored in an internal RAM and not in the EEPROM. It is valid until switching off the supply voltage. If the values should be permanently stored in the EEPROM, the “STORE” command must be used before switching off the supply voltage.

#### Step 2: Calculation of $V_{OQ}$ and Sensitivity

The calibration points 1 and 2 can be set inside the specified range. The corresponding values for  $V_{OUT1}$  and  $V_{OUT2}$  result from the application requirements.

*Low clamping voltage  $\leq V_{OUT1,2} \leq$  High clamping voltage*

For highest accuracy of the sensor, calibration points near the minimum and maximum input signal are recommended. The difference of the output voltage between calibration point 1 and calibration point 2 should be more than 3.5 V.

Set the system to calibration point 1 and read the register ADC-READOUT. The result is the value ADC-READOUT1.

Now, set the system to calibration point 2, read the register ADC-READOUT again, and get the value ADC-READOUT2.

With these values and the target values  $V_{OUT1}$  and  $V_{OUT2}$ , for the calibration points 1 and 2, respectively, the values for Sensitivity and  $V_{OQ}$  are calculated as:

$$\text{Sensitivity} = \frac{V_{OUT1} - V_{OUT2}}{\text{ADC-READOUT1} - \text{ADC-READOUT2}} * \frac{2048}{V_{DD}}$$

$$V_{OQ} = V_{OUT1} - \frac{\text{ADC-READOUT1} * \text{Sensitivity} * V_{DD}}{2048}$$

This calculation has to be done individually for each sensor.

Now, write the calculated values for Sensitivity and  $V_{OQ}$  for adjusting the sensor.

Use the “STORE” command for permanently storing the EEPROM registers. The sensor is now calibrated for the customer application. However, the programming can be changed again and again if necessary.

#### Step 3: Locking the Sensor

The last step is activating the LOCK function with the “LOCK” command. The sensor is now locked and does not respond to any programming or reading commands.

**Warning:** This register cannot be reset!

## 2.3.2. Calibration of Angle Sensor

The following description explains the calibration procedure using an angle sensor as an example. The required output characteristic is shown in Fig. 2–8.

- the angle range is from  $-25^\circ$  to  $25^\circ$
- temperature coefficient of the magnet:  $-500$  ppm/K

### Step 1: Input of the registers which need not to be adjusted individually

The register values for the following registers are given for all applications:

- FILTER  
Select the filter frequency: 500 Hz
- RANGE  
Select the magnetic field range: 30 mT
- TC  
For this magnetic material: 1
- TCSQ  
For this magnetic material: 12
- CLAMP-LOW  
For our example: 0.5 V
- CLAMP-HIGH  
For our example: 4.5 V

Enter these values in the software, and use the “WRITE” command for writing the values in the registers.

### Step 2: Calculation of $V_{OQ}$ and Sensitivity

There are 2 ways to calculate the values for  $V_{OQ}$  and Sensitivity

Manual Calculation:

Set the system to calibration point 1 (angle 1 =  $-25^\circ$ ) and read the register ADC-READOUT. For our example, the result is ADC-READOUT1 =  $-2500$ .

Now, set the system to calibration point 2 (angle 2 =  $25^\circ$ ), and read the register ADC-READOUT again. For our example, the result is ADC-READOUT2 =  $+2350$ .

With these measurements and the targets  $V_{OUT1} = 4.5$  V and  $V_{OUT2} = 0.5$  V, the values for Sensitivity and  $V_{OQ}$  are

$$\text{Sensitivity} = \frac{4.5 \text{ V} - 0.5 \text{ V}}{-2500 - 2350} * \frac{2048}{5 \text{ V}} = -0.3378$$

$$V_{OQ} = 4.5 \text{ V} - \frac{-2500 * (-0.3378) * 5 \text{ V}}{2048} = 2.438 \text{ V}$$

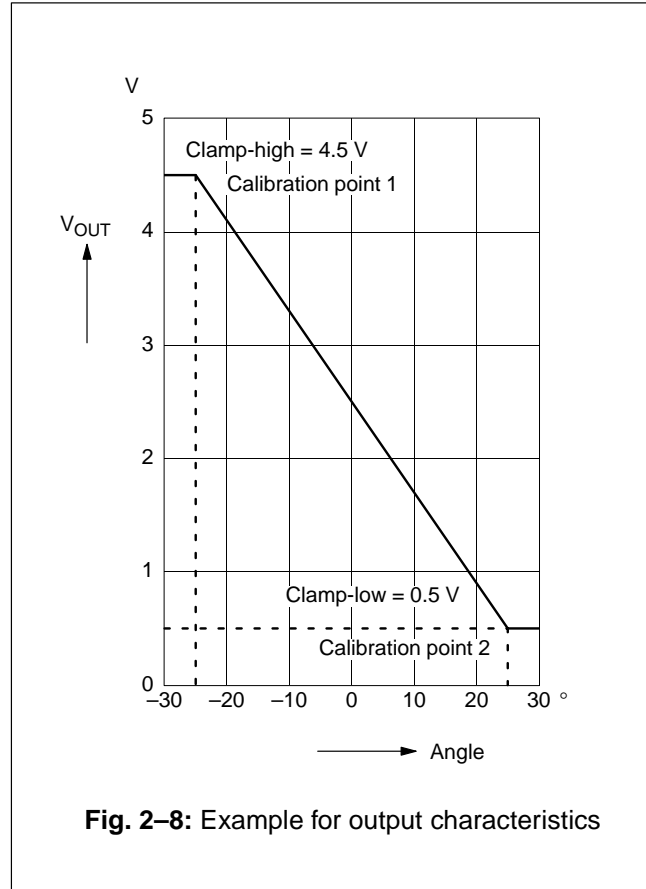

Fig. 2–8: Example for output characteristics

This calculation has to be done individually for each sensor.

Automatic Calibration:

Use the menu CALIBRATE from the PC software and enter the values 4.5 V for  $V_{OUT1}$  and 0.5 V for  $V_{OUT2}$ . Set the system to calibration point 1 (angle 1 =  $-25^\circ$ ), hit the button Read ADC-Readout1, set the system to calibration point 2 (angle 2 =  $25^\circ$ ), hit the button Read ADC-Readout2, and hit the button Calculate. The software will then calculate the appropriate  $V_{OQ}$  and Sensitivity.

Now, write the calculated values into the HAL 800 for programming the sensor and use the “STORE” command for permanently storing the EEPROM registers.

### Step 3: Locking the Sensor

The last step is activating the LOCK function with the “LOCK” command. The sensor is now locked and does not respond to any programming or reading commands.

**Warning:** This register cannot be reset!

3. Specifications

3.1. Outline Dimensions

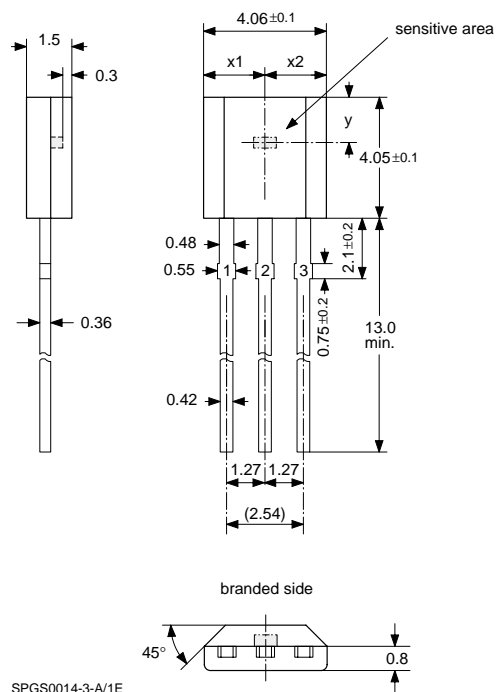

**Fig. 3-1:**  
 Plastic Transistor Single Outline Package  
**(TO-92UT)**  
 Weight approximately 0.14 g  
 Dimensions in mm  
 A mechanical tolerance of ±50 μm applies to all dimensions where no tolerance is explicitly given.

3.2. Dimensions of Sensitive Area

0.25 mm x 0.25 mm

3.3. Position of Sensitive Area

TO-92UT
$ x1 - x2  / 2 \leq 0.2 \text{ mm}$
$y = 1.5 \text{ mm} \pm 0.2 \text{ mm}$

## 3.4. Absolute Maximum Ratings

Symbol	Parameter	Pin No.	Min.	Max.	Unit
$V_{DD}$	Supply Voltage	1	-8.5	8.5	V
$V_{DD}$	Supply Voltage	1	-14.4 <sup>1) 2)</sup>	14.4 <sup>1) 2)</sup>	V
$-I_{DD}$	Reverse Supply Current	1	-	50 <sup>1)</sup>	mA
$I_Z$	Current through Protection Device	1 or 3	-300 <sup>4)</sup>	300 <sup>4)</sup>	mA
$V_{OUT}$	Output Voltage	3	-5 <sup>6)</sup> -5 <sup>6)</sup>	8.5 <sup>3)</sup> 14.4 <sup>3) 2)</sup>	V
$V_{OUT} - V_{DD}$	Excess of Output Voltage over Supply Voltage	3,1		2	V
$I_{OUT}$	Continuous Output Current	3	-10	10	mA
$t_{Sh}$	Output Short Circuit Duration	3	-	10	min
$T_S$	Storage Temperature Range		-65	150	°C
$T_J$	Junction Temperature Range		-40 -40	170 <sup>5)</sup> 150	°C °C

1) as long as  $T_{Jmax}$  is not exceeded  
 2)  $t < 10$  minutes ( $V_{DDmin} = -15$  V for  $t < 1$ min,  $V_{DDmax} = 16$  V for  $t < 1$ min)  
 3) as long as  $T_{Jmax}$  is not exceeded, output is not protected to external 14 V-line (or to -14 V)  
 4)  $t < 2$  ms  
 5)  $t < 1000$ h  
 6) internal protection resistor = 100  $\Omega$

Stresses beyond those listed in the “Absolute Maximum Ratings” may cause permanent damage to the device. This is a stress rating only. Functional operation of the device at these or any other conditions beyond those indicated in the “Recommended Operating Conditions/Characteristics” of this specification is not implied. Exposure to absolute maximum ratings conditions for extended periods may affect device reliability.

## 3.5. Recommended Operating Conditions

Symbol	Parameter	Pin No.	Min.	Typ.	Max.	Unit
$V_{DD}$	Supply Voltage	1	4.5	5	5.5	V
$I_{OUT}$	Continuous Output Current	3	-1	-	1	mA
$R_L$	Load Resistor	3	4.5	-	-	k $\Omega$
$C_L$	Load Capacitance	3	0.33	10	1000	nF

### 3.6. Electrical Characteristics

at  $T_J = -40\text{ }^\circ\text{C}$  to  $+170\text{ }^\circ\text{C}$ ,  $V_{DD} = 4.5\text{ V}$  to  $5.5\text{ V}$ , after programming, as not otherwise specified in Conditions.  
 Typical Characteristics for  $T_J = 25\text{ }^\circ\text{C}$  and  $V_{DD} = 5\text{ V}$ .

Symbol	Parameter	Pin No.	Min.	Typ.	Max.	Unit	Conditions
$I_{DD}$	Supply Current	1		7	10	mA	$T_J = 25\text{ }^\circ\text{C}$ , $V_{DD} = 4.5\text{ V}$ to $8.5\text{ V}$
$I_{DD}$	Supply Current over Temperature Range	1		7	10	mA	
$V_{DDZ}$	Overvoltage Protection at Supply	1		17.5	20	V	$I_{DD} = 25\text{ mA}$ , $T_J = 25\text{ }^\circ\text{C}$ , $t = 20\text{ ms}$
$V_{OZ}$	Overvoltage Protection at Output	3		17	19.5	V	$I_O = 10\text{ mA}$ , $T_J = 25\text{ }^\circ\text{C}$ , $t = 20\text{ ms}$
	Resolution	3		12		bit	ratiometric to $V_{DD}$ <sup>1)</sup>
$E_A$	Accuracy Error over all	3	-2	0	2	%	$R_L = 4.7\text{ k}\Omega$ (% of supply voltage) <sup>3)</sup>
INL	Non-Linearity of Output Voltage over Temperature	3	-1	0	1	%	% of supply voltage <sup>3)</sup>
$E_R$	Ratiometric Error of Output over Temperature (Error in $V_{OUT} / V_{DD}$ )	3	-1	0	1	%	$ V_{OUT1} - V_{OUT2}  > 2\text{ V}$ during calibration procedure
$\Delta V_{OUTCL}$	Accuracy of Output Voltage at Clamping Low Voltage over Temperature Range	3	-45	0	45	mV	$R_L = 4.7\text{ k}\Omega$ , $V_{DD} = 5\text{ V}$
$\Delta V_{OUTCH}$	Accuracy of Output Voltage at Clamping High Voltage over Temperature Range	3	-45	0	45	mV	$R_L = 4.7\text{ k}\Omega$ , $V_{DD} = 5\text{ V}$
$V_{OUTH}$	Output High Voltage	3	4.65	4.8		V	$V_{DD} = 5\text{ V}$ , $-1\text{ mA} \leq I_{OUT} \leq 1\text{ mA}$
$V_{OUTL}$	Output Low Voltage	3		0.2	0.35	V	$V_{DD} = 5\text{ V}$ , $-1\text{ mA} \leq I_{OUT} \leq 1\text{ mA}$
$f_{ADC}$	Internal ADC Frequency	-	120	128	140	kHz	$T_J = 25\text{ }^\circ\text{C}$
$f_{ADC}$	Internal ADC Frequency over Temperature Range	-	110	128	150	kHz	$V_{DD} = 4.5\text{ V}$ to $8.5\text{ V}$
$t_{r(O)}$	Response Time of Output	3	-	2 1	4 2	ms ms	3 dB Filter frequency = 500 Hz 3 dB Filter frequency = 2 kHz $C_L = 10\text{ nF}$ , time from 10% to 90% of final output voltage for a steplike signal $B_{step}$ from 0 mT to $B_{max}$
$t_{d(O)}$	Delay Time of Output	3		0.1	0.5	ms	
$t_{POD}$	Power-Up Time (Time to reach stabilized Output Voltage)			3 2	5 3	ms	3 dB Filter frequency = 500 Hz 3 dB Filter frequency = 2 kHz 90% of $V_{OUT}$
BW	Small Signal Bandwidth (-3 dB)	3	-	2	-	kHz	$B_{AC} < 10\text{ mT}$ ; 3 dB Filter frequency = 2 kHz
$V_{OUTn}$	Noise Output Voltage <sub>pp</sub>	3	-	3	6	mV	<sup>2)</sup> magnetic range = 90 mT
$R_{OUT}$	Output Resistance over Recommended Operating Range	3	-	1	10	$\Omega$	$V_{OUTL} \leq V_{OUT} \leq V_{OUTH}$
$R_{thJA}$ TO-92UT	Thermal Resistance Junction to Soldering Point	-	-	150	200	K/W	

<sup>1)</sup> Output DAC full scale = 5 V ratiometric, Output DAC offset = 0 V, Output DAC LSB =  $V_{DD}/4096$   
<sup>2)</sup> peak-to-peak value exceeded: 5%  
<sup>3)</sup> if more than 50% of the selected magnetic field range are used

## 3.7. Magnetic Characteristics

at  $T_J = -40\text{ °C}$  to  $+170\text{ °C}$ ,  $V_{DD} = 4.5\text{ V}$  to  $5.5\text{ V}$ , after programming, as not otherwise specified in Conditions.  
 Typical Characteristics for  $T_J = 25\text{ °C}$  and  $V_{DD} = 5\text{ V}$ .

Symbol	Parameter	Pin No.	Min.	Typ.	Max.	Unit	Test Conditions
$B_{\text{Offset}}$	Magnetic Offset	3	-1	0	1	mT	$B = 0\text{ mT}$ , $I_{\text{OUT}} = 0\text{ mA}$ , $T_J = 25\text{ °C}$
$\Delta B_{\text{Offset}}/\Delta T$	Magnetic Offset Change due to $T_J$		-15	0	15	$\mu\text{T/K}$	$B = 0\text{ mT}$ , $I_{\text{OUT}} = 0\text{ mA}$
$B_{\text{Hysteresis}}$	Magnetic Hysteresis		-20	0	20	$\mu\text{T}$	Range = 30 mT, Filter = 500 Hz
SR	Magnetic Slew Rate	3	-	12 50	-	mT/ms	Filter frequency = 500 Hz Filter frequency = 2 kHz
$n_{\text{meff}}$	Magnetic RMS Broadband Noise	3	-	10	-	$\mu\text{T}$	BW = 10 Hz to 2 kHz
$f_{\text{Cflicker}}$	Corner Frequency of 1/f Noise	3	-	20		Hz	$B = 0\text{ mT}$
$f_{\text{Cflicker}}$	Corner Frequency of 1/frms Noise	3	-	100		Hz	$B = 65\text{ mT}$ , $T_J = 25\text{ °C}$

## 3.8. Typical Characteristics

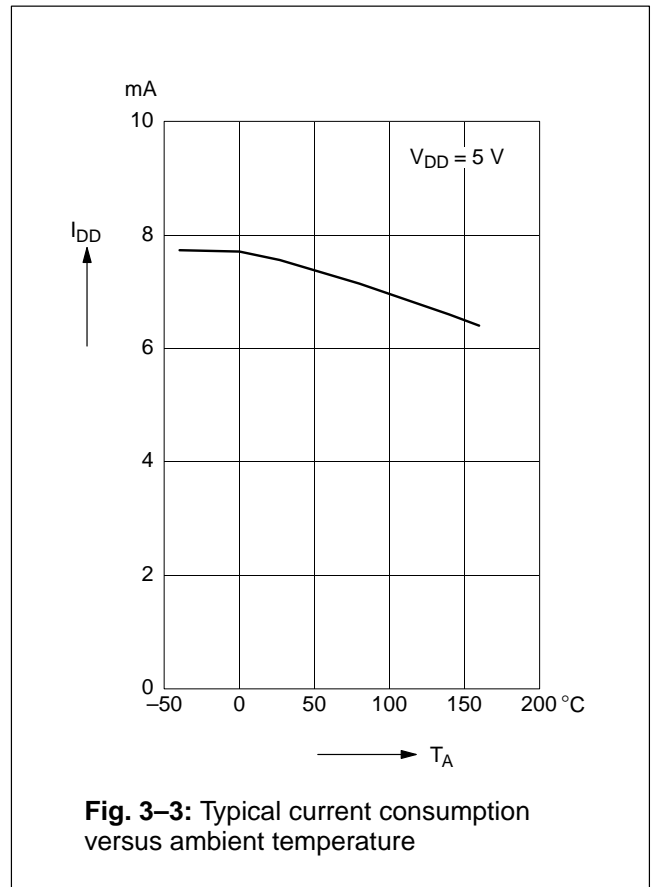
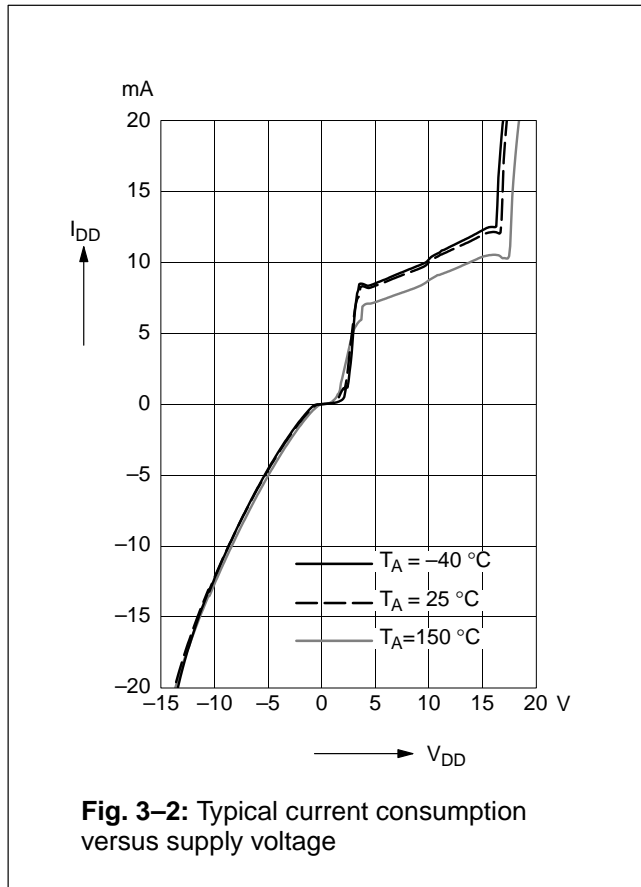

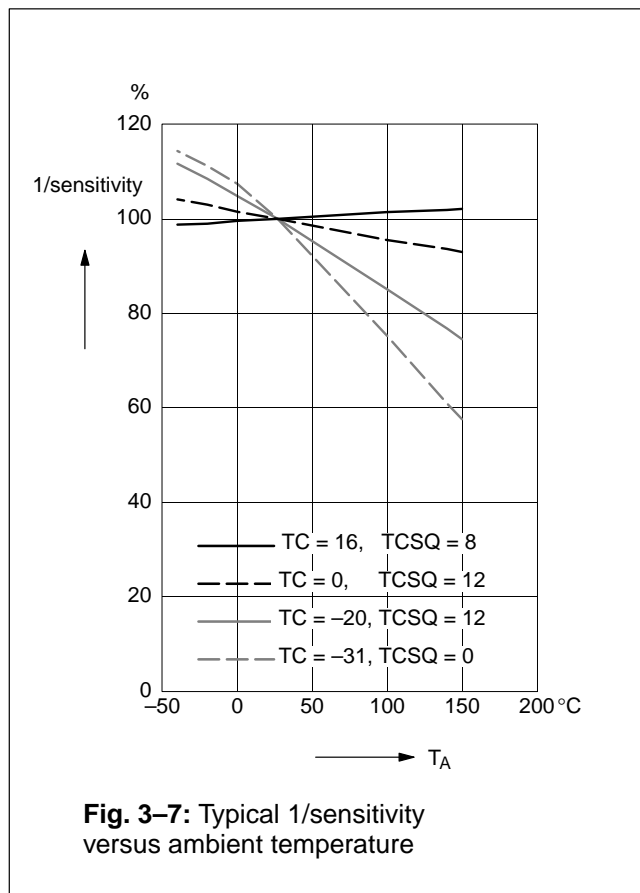
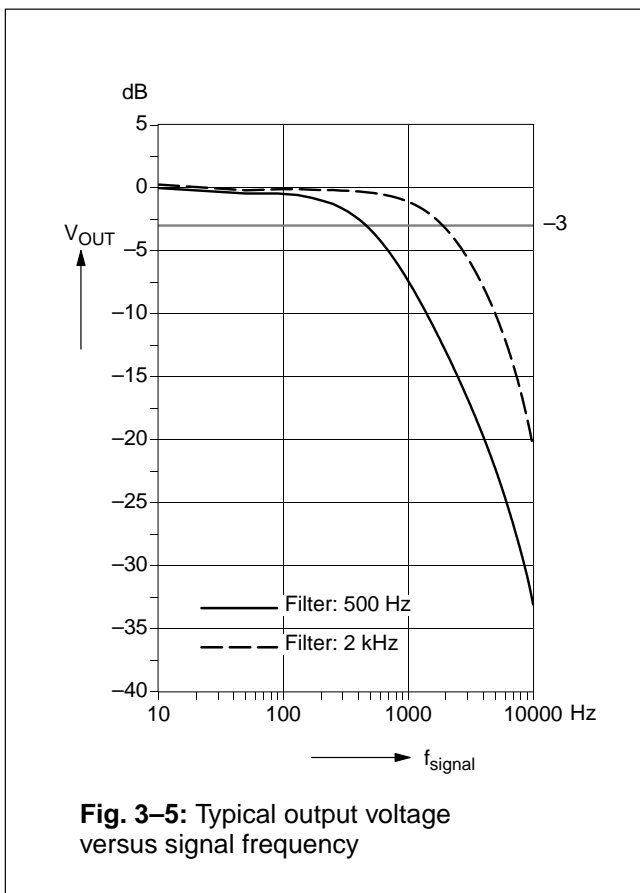
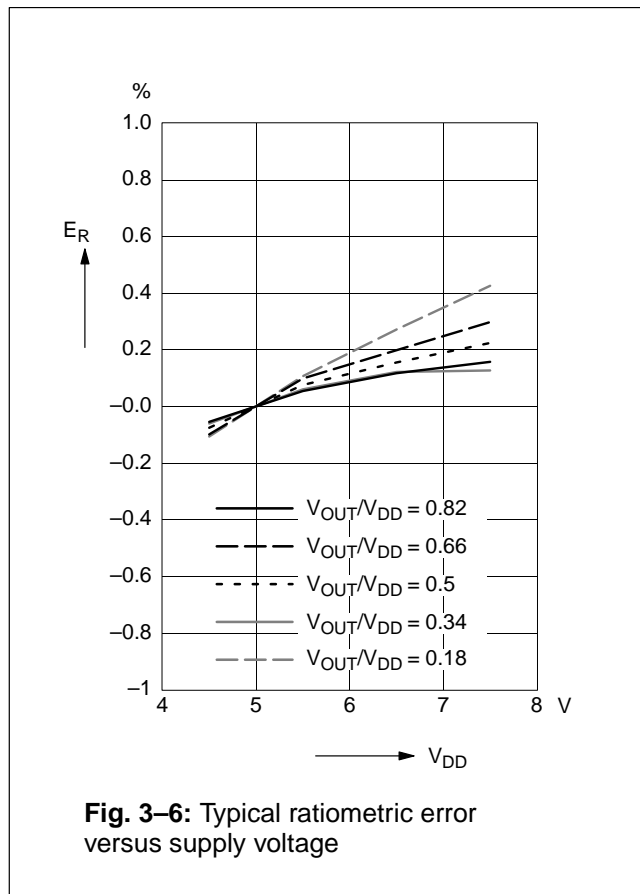
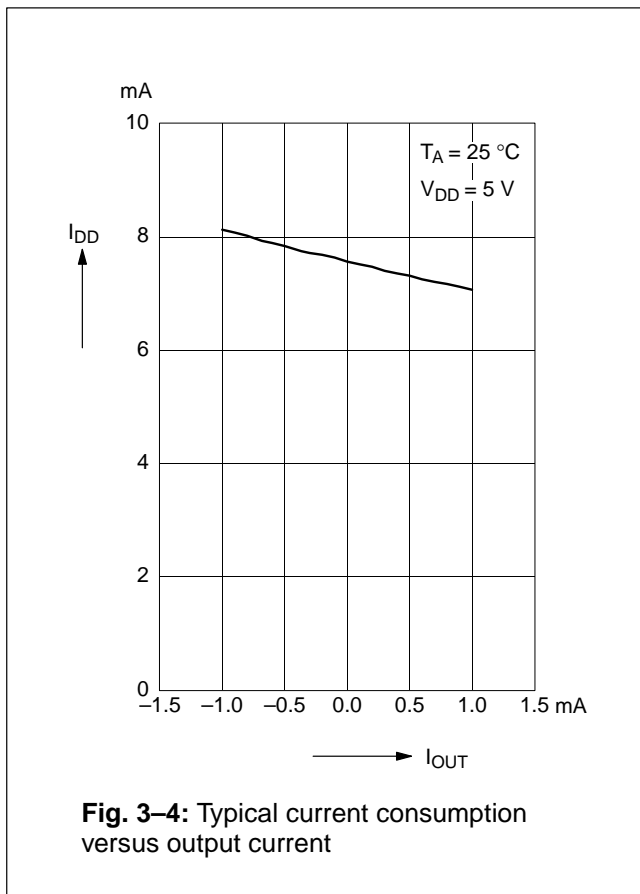

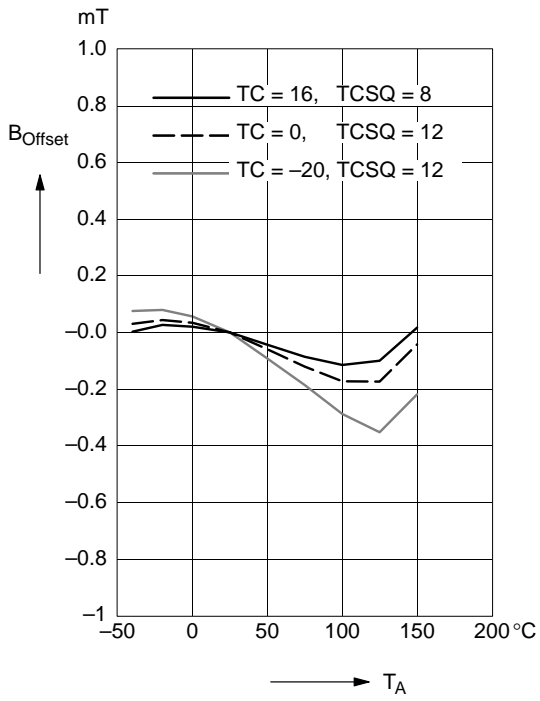

**Fig. 3-8:** Typical magnetic offset versus ambient temperature

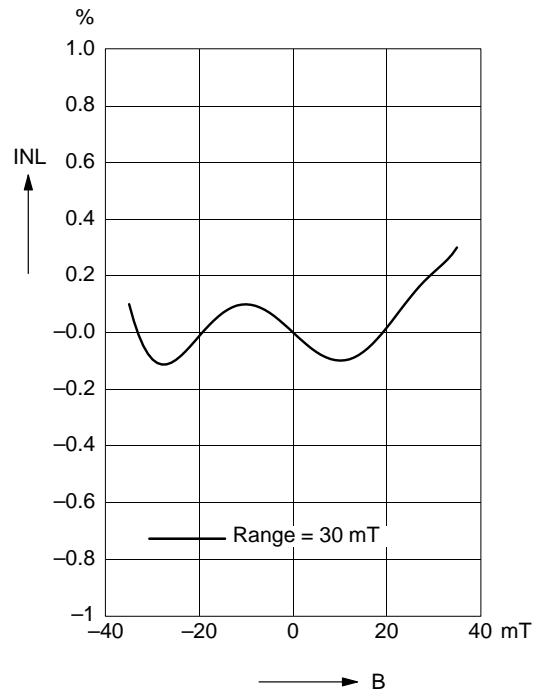

**Fig. 3-9:** Typical nonlinearity versus magnetic field



## 4. Application Notes

### 4.1. Application Circuit

For EMC protection, it is recommended to add each a ceramic 4.7 nF capacitor between ground and the supply voltage respectively the output voltage pin. In addition, the input of the controller unit should be pulled-down with a 4.7 kOhm resistor and a ceramic 4.7 nF capacitor.

Please note that during programming, the sensor will be supplied repeatedly with the programming voltage of 12 V for 100 ms. All components connected to the V<sub>DD</sub> line at this time must be able to resist this voltage.

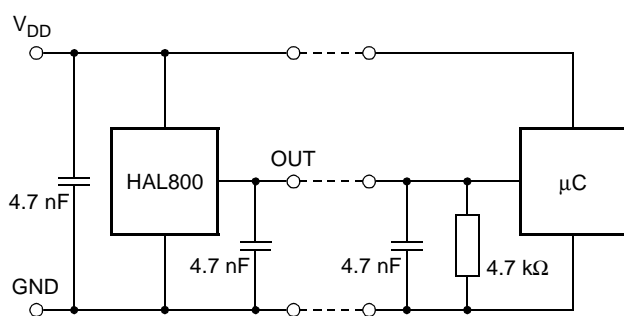

Fig. 4-1: Recommended application circuit

### 4.2. Temperature Compensation

The relation between the temperature coefficient of the magnet and the corresponding TC and TCSQ codes for a linear compensation is given in the following table. In addition to the linear change of the magnetic field with temperature, the curvature can be adjusted, too. For that purpose, TC and TCSQ have to be changed to combinations that are not given in the table. Please contact Micronas for more detailed information.

Temperature Coefficient of Magnet (ppm/K)	TC	TCSQ
700	29	8
600	26	9
500	23	9
400	21	9
300	18	9
200	16	9
100	14	10

Temperature Coefficient of Magnet (ppm/K)	TC	TCSQ
0	11	10
-100	8	10
-200	6	11
-300	4	11
-400	3	12
-500	1	12
-600	-1	13
-700	-3	13
-800	-5	14
-900	-6	14
-1000	-8	15
-1100	-9	15
-1200	-11	16
-1300	-13	17
-1400	-14	17
-1500	-15	18
-1600	-17	18
-1700	-18	18
-1800	-19	19
-1900	-20	19
-2000	-22	20
-2100	-23	21
-2200	-24	21
-2300	-25	22
-2400	-26	22
-2500	-27	23
-2600	-28	23
-2700	-29	24
-2800	-30	24
-2900	-31	26

## 4.3. Ambient Temperature

Due to the internal power dissipation, the temperature on the silicon chip (junction temperature  $T_J$ ) is higher than the temperature outside the package (ambient temperature  $T_A$ ).

$$T_J = T_A + \Delta T$$

At static conditions, the following equation is valid:

$$\Delta T = I_{DD} * V_{DD} * R_{thJA}$$

For typical values, use the typical parameters. For worst case calculation, use the max. parameters for  $I_{DD}$  and  $R_{th}$ , and the max. value for  $V_{DD}$  from the application.

For  $V_{DD} = 5.5$  V,  $R_{th} = 200$  K/W and  $I_{DD} = 10$  mA the temperature difference  $\Delta T = 11$  K.

For all sensors, the junction temperature  $T_J$  is specified. The maximum ambient temperature  $T_{Amax}$  can be calculated as:

$$T_{Amax} = T_{Jmax} - \Delta T$$

## 4.4. EMC and ESD

The HAL 800 is designed for a stabilized 5 V supply. Interferences and disturbances conducted along the 12 V onboard system (product standards DIN40839 part 1 or ISO 7637 part 1) are not relevant for these applications.

For applications with disturbances by capacitive or inductive coupling on the supply line or radiated disturbances, the application circuit shown in Fig. 4–1 is recommended.

Applications with this arrangement passed the EMC tests according to the product standards DIN 40839 part 3 (Electrical transient transmission by capacitive or inductive coupling) and part 4 (Radiated disturbances).

Please contact Micronas for the detailed investigation reports with the EMC and ESD results.

## 5. Programming of the Sensor

### 5.1. Definition of Programming Pulses

The sensor is addressed by modulating a serial telegram on the supply voltage. The sensor answers with a serial telegram on the output pin.

The bits in the serial telegram have a different Bit time for the  $V_{DD}$ -line and the output. The Bit time for the  $V_{DD}$ -line is defined through the length of the Sync Bit at the beginning of each telegram. The Bit time for the output is defined through the Acknowledge Bit.

A logical 0 is coded as no voltage change within the Bit time. A logical 1 is coded as a voltage change between 50% and 80% of the Bit time. After each bit a voltage change occurs.

### 5.2. Definition of the Telegram

Each telegram starts with the Sync Bit (logical 0), 3 bits for the Command (COM), the Command Parity Bit (CP), 4 bits for the Address (ADR), and the Address Parity Bit (AP).

There are 3 kinds of telegrams:

- Write a register (see Fig. 5–2)  
After the AP Bit follow 14 Data Bits (DAT) and the Data Parity Bit (DP). If the telegram is valid and the

command has been processed the sensor answers with an Acknowledge Bit (logical 0) on the output.

- Read a register (see Fig. 5–3)  
After evaluating this command the sensor answers with the Acknowledge Bit, 14 Data Bits, and the Data Parity Bit on the output.
- Programming the EEPROM cells (see Fig. 5–4)  
After evaluating this command the sensor answers with the Acknowledge Bit. After the delay time  $t_w$  the supply voltage rises up to the programming voltage.

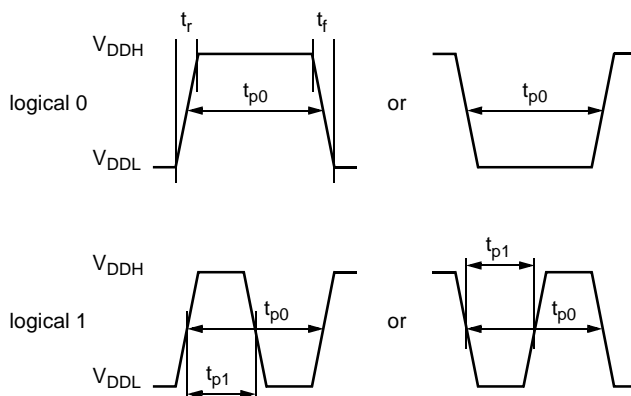
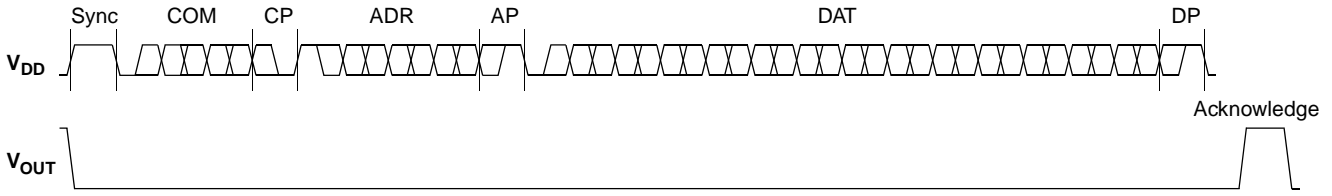

Fig. 5–1: Definition of logical 0 and 1 bit

Table 5–1: Telegram parameters

Symbol	Parameter	Pin	Min.	Typ.	Max.	Unit	Remarks
$V_{DDL}$	Supply Voltage for Low Level during Programming	1	5	5.6	6	V	
$V_{DDH}$	Supply Voltage for High Level during Programming	1	6.8	8.0	8.5	V	
$t_r$	Rise time	1			0.05	ms	
$t_f$	Fall time	1			0.05	ms	
$t_{p0}$	Bit time on $V_{DD}$	1	3.4	3.5	3.6	ms	$t_{p0}$ is defined through the Sync Bit
$t_{pOUT}$	Bit time on output pin	3	4	6	8	ms	$t_{pOUT}$ is defined through the Acknowledge Bit
$t_{p1}$	Voltage Change for logical 1	1, 3	50	65	80	%	% of $t_{p0}$ or $t_{pOUT}$
$V_{DDPROG}$	Supply Voltage for Programming the EEPROM	1	11.95	12	12.1	V	
$t_{PROG}$	Programming Time for EEPROM	1	95	100	105	ms	
$t_{rp}$	Rise time of programming voltage	1	0.2	0.5	1	ms	
$t_{fp}$	Fall time of programming voltage	1	0		1	ms	
$t_w$	Delay time of programming voltage after Acknowledge	1	0.5	0.7	1	ms	

## WRITE



**Fig. 5–2:** Telegram for coding a Write command

## READ

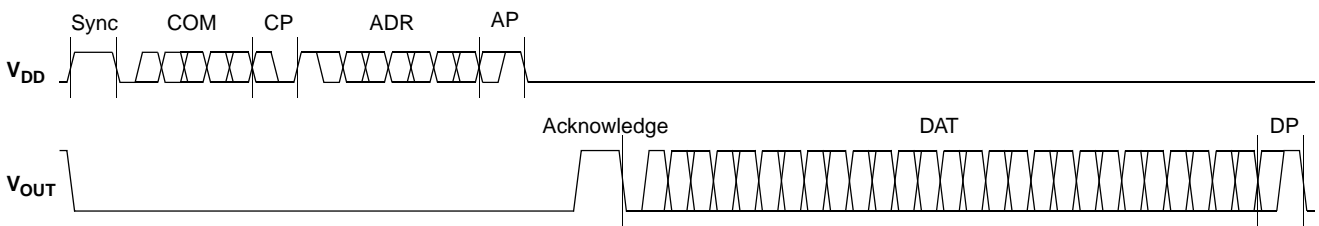

**Fig. 5–3:** Telegram for coding a Read command

## ERASE, PROM, LOCK, and LOCKI

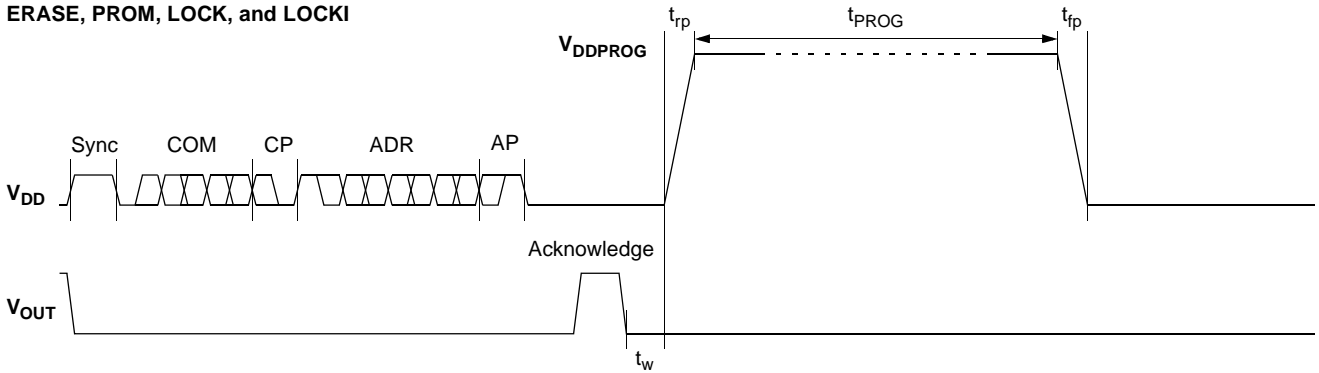

**Fig. 5–4:** Telegram for coding the EEPROM programming

**5.3. Telegram Codes**

**Sync Bit**

Each telegram starts with the Sync Bit. This logical 0 pulse defines the exact timing for  $t_{p0}$ .

**Command Bits (COM)**

The Command code contains 3 bits and is a binary number. Table 5–2 shows the available commands and the corresponding codes for the HAL 800.

**Command Parity Bit (CP)**

This parity bit is 1, if the number of zeros within the 3 Command Bits is uneven. The parity bit is 0, if the number of zeros is even.

**Address Bits (ADR)**

The Address code contains 4 bits and is a binary number. Table 5–3 shows the available addresses for the HAL 800 registers.

**Address parity bit (AP)**

This parity bit is 1, if the number of zeros within the 4 Address bits is uneven. The parity bit is 0, if the number of zeros is even.

**Data Bits (DAT)**

The 14 Data Bits contain the register information.

The registers use different number formats for the Data Bits. These formats are explained in Section 5.4.

In the Write command the last bits are valid. If for example the TC register (6 bits) is written, only the last 6 bits are valid.

In the Read command the first bits are valid. If for example the TC register (6 bits) is read, only the first 6 bits are valid.

**Data Parity Bit (DP)**

This parity bit is 1, if the number of zeros within the binary number is even. The parity bit is 0, if the number of zeros is uneven.

**Table 5–2:** Available Commands

Command	Code	Explanation
READ	2	read a register
WRITE	3	write a register
PROM	4	program all nonvolatile registers (except the lock bits)
ERASE	5	erase all nonvolatile registers (except the lock bits)
LOCKI	6	lock Micronas lockable register
LOCK	7	lock the whole device and switch permanently to the analog-mode
<p><b>Please note:</b> The Micronas lock bit (LOCKI) has already been set during production and cannot be reset.</p>		

## 5.4. Number Formats

### Binary number:

The most significant bit is given as first, the least significant bit as last digit.

Example: 101001 represents 41 decimal.

### Signed binary number:

The first digit represents the sign of the following binary number (1 for negative, 0 for positive sign).

Example: 0101001 represents +41 decimal  
1101001 represents -41 decimal

### Two-complementary number:

The first digit of positive numbers is 0, the rest of the number is a binary number. Negative numbers start with 1. In order to calculate the absolute value of the number, you have to calculate the complement of the remaining digits and to add 1.

Example: 0101001 represents +41 decimal  
1010111 represents -41 decimal

**Table 5–3:** Available register addresses

Parameter	Code	Data Bits	Format	Customer	Remark
CLAMP-LOW	1	10	binary	read/write/program	Low clamping voltage
CLAMP-HIGH	2	11	binary	read/write/program	High clamping voltage
VOQ	3	11	two compl. binary	read/write/program	
SENSITIVITY	4	14	signed binary	read/write/program	
MODE	5	3	binary	read/write/program	Range and filter parameters see Table 5–4 for details
LOCKR	6	1	binary	lock	Lock Bit
ADC-READOUT	7	14	two compl. binary	read	
TC	11	6	signed binary	read/write/program	
TCSQ	12	5	binary	read/write/program	

Micronas registers (read only for customers)

Parameter	Code	Data Bits	Format	Remark
OFFSET	8	4	two compl. binary	ADC offset adjustment
FOSCAD	9	5	binary	Oscillator frequency adjustment
SPECIAL	13	6		special settings
IMLOCK	14	1	binary	Lock Bit for the Micronas registers

**5.5. Register Information**

**CLAMP-LOW**

- The register range is from 0 up to 1023.
- The register value is calculated by:

$$CLAMP-LOW = \frac{Low\ Clamping\ Voltage}{V_{DD}} * 2048$$

**CLAMP-HIGH**

- The register range is from 0 up to 2047.
- The register value is calculated by:

$$CLAMP-HIGH = \frac{High\ Clamping\ Voltage}{V_{DD}} * 2048$$

**VOQ**

- The register range is from -1024 up to 1023.
- The register value is calculated by:

$$VOQ = \frac{V_{OQ}}{V_{DD}} * 1024$$

**SENSITIVITY**

- The register range is from -8192 up to 8191.
- The register value is calculated by:

$$SENSITIVITY = \frac{Sensitivity}{2048}$$

**MODE**

- The register range is from 0 up to 7 and contains the settings for FILTER and RANGE

**ADC-READOUT**

- This register is read only.
- The register range is from -8192 up to 8191.

**TC and TCSQ**

- The TC register range is from -31 up to 31,
- The TCSQ register range is from 0 up to 31.

Please refer Section 4.2. on page 17 for the recommended values.

**5.6. Programming Information**

If you want to change the content of any register (except the lock registers) you have to write the desired value into the corresponding RAM register at first.

If you want to permanently store the value in the EEPROM, you have to send an ERASE command first and a PROM command afterwards. The address within the ERASE and PROM command is not important. ERASE and PROM acts on all registers in parallel.

If you want to change all registers of the HAL 800, you can send all writing commands one after each other and send one ERASE and PROM command at the end.

**Table 5-4:** Parameters for the MODE register

MODE	FILTER	-3 dB Frequency	RANGE	Magnetic Field Range
0	0	2 kHz	0	-30 mT...30 mT
1	0	2 kHz	1	-75 mT...75 mT
2	0	2 kHz	2	-90 mT...90 mT
3	0	2 kHz	3	-150 mT...150 mT
4	1	500 Hz	0	-30 mT...30 mT
5	1	500 Hz	1	-75 mT...75 mT
6	1	500 Hz	2	-90 mT...90 mT
7	1	500 Hz	3	-150 mT...150 mT

## 6. Data Sheet History

1. Advance information: "HAL 800 Programmable Linear Hall Effect Sensor, Aug. 24, 1998, 6251-441-1AI. First release of the advance information.

2. Final data sheet: "HAL 800 Programmable Linear Hall Effect Sensor, Oct. 20, 1999, 6251-441-1DS. First release of the final data sheet.

Micronas GmbH  
Hans-Bunte-Strasse 19  
D-79108 Freiburg (Germany)  
P.O. Box 840  
D-79008 Freiburg (Germany)  
Tel. +49-761-517-0  
Fax +49-761-517-2174  
E-mail: [docservice@micronas.com](mailto:docservice@micronas.com)  
Internet: [www.micronas.com](http://www.micronas.com)

Printed in Germany  
Order No. 6251-441-1DS

All information and data contained in this data sheet are without any commitment, are not to be considered as an offer for conclusion of a contract, nor shall they be construed as to create any liability. Any new issue of this data sheet invalidates previous issues. Product availability and delivery are exclusively subject to our respective order confirmation form; the same applies to orders based on development samples delivered. By this publication, Micronas GmbH does not assume responsibility for patent infringements or other rights of third parties which may result from its use.

Further, Micronas GmbH reserves the right to revise this publication and to make changes to its content, at any time, without obligation to notify any person or entity of such revisions or changes.

No part of this publication may be reproduced, photocopied, stored on a retrieval system, or transmitted without the express written consent of Micronas GmbH.