

**PLEASE CHECK WWW.MOLEX.COM FOR LATEST PART INFORMATION**

**Part Number:** [0311010041](#)  
**Status:** **Active**  
**Overview:** [hdac 64 single row](#)  
**Description:** H-DAC 64™ 2.54mm (.100") 4 Way Vertical Header Assembly, Polarization B

**Documents:**

[Drawing \(PDF\)](#) [Product Specification PS-31100-0001 \(PDF\)](#)  
[Application Specification \(PDF\)](#) [RoHS Certificate of Compliance \(PDF\)](#)

**General**

Product Family	PCB Headers
Series	<a href="#">31101</a>
Application	Wire-to-Board
Comments	Polarization Option B, Gray
Overview	<a href="#">hdac 64 single row</a>
Product Name	H-DAC 64™

**Physical**

Breakaway	No
Circuits (Loaded)	4
Circuits (maximum)	4
Color - Resin	Gray
Durability (mating cycles max)	10
First Mate / Last Break	No
Glow-Wire Compliant	No
Guide to Mating Part	No
Keying to Mating Part	None
Lock to Mating Part	Yes
Material - Metal	Brass
Material - Plating Mating	Tin
Material - Plating Termination	Nickel
Material - Resin	Modified Polystyrene
Number of Rows	1
Orientation	Right Angle
PC Tail Length (in)	0.145 In
PC Tail Length (mm)	3.68 mm
PCB Locator	Yes
PCB Retention	Yes
PCB Thickness Recommended (in)	0.062 In
PCB Thickness Recommended (mm)	1.57 mm
Packaging Type	Tray
Pitch - Mating Interface (in)	0.100 In
Pitch - Mating Interface (mm)	2.54 mm
Pitch - Term. Interface (in)	0.100 In
Pitch - Term. Interface (mm)	2.54 mm
Plating min: Mating (µin)	60
Plating min: Mating (µm)	1.50
Plating min: Termination (µin)	60
Plating min: Termination (µm)	1.50
Polarized to Mating Part	Yes
Polarized to PCB	Yes
Shrouded	Closed Ends
Stackable	No
Surface Mount Compatible (SMC)	No
Temperature Range - Operating	-40°C to +100°C
Termination Interface: Style	Through Hole

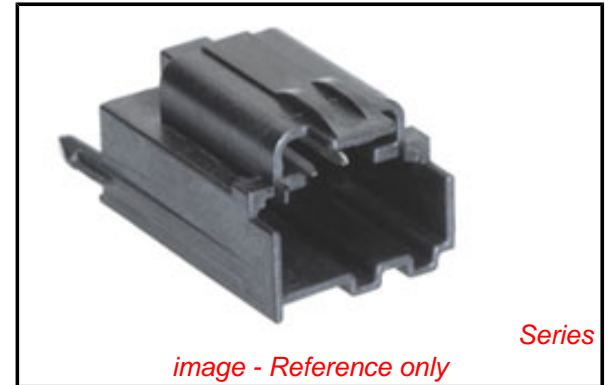

*image - Reference only*

**EU RoHS**

**ELV and RoHS  
Compliant**  
**REACH SVHC  
Contains SVHC: No**  
**Halogen-Free  
Status**

**China RoHS**



**Not Reviewed**

**Need more information on product  
environmental compliance?**

Email [productcompliance@molex.com](mailto:productcompliance@molex.com)  
For a multiple part number RoHS Certificate of  
Compliance, [click here](#)

Please visit the [Contact Us](#) section for any  
non-product compliance questions.

**Search Parts in this Series**

[31101Series](#)

**Mates With**

H-DAC 64™, 4 Way Receptacle Assembly  
[310681011](#)

**Electrical**

Current - Maximum per Contact	5A, 7A
Voltage - Maximum	500V DC

**Solder Process Data**

Duration at Max. Process Temperature (seconds)	40
Lead-free Process Capability	SMC & Wave Capable (TH only)
Max. Cycles at Max. Process Temperature	3
Process Temperature max. C	260

**Material Info****Reference - Drawing Numbers**

Application Specification	AS-31067-100
Packaging Specification	PK-31300-707
Product Specification	PS-31100-0001
Sales Drawing	SD-31206-003

This document was generated on 05/24/2010

**PLEASE CHECK [WWW.MOLEX.COM](http://WWW.MOLEX.COM) FOR LATEST PART INFORMATION**

3 WAY VERTICAL  
HEADER ASSEMBLY  
(POLARIZATION OPTIONS)  
VIEWED FROM MATE SIDE

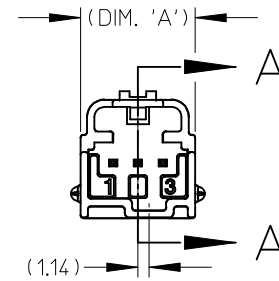
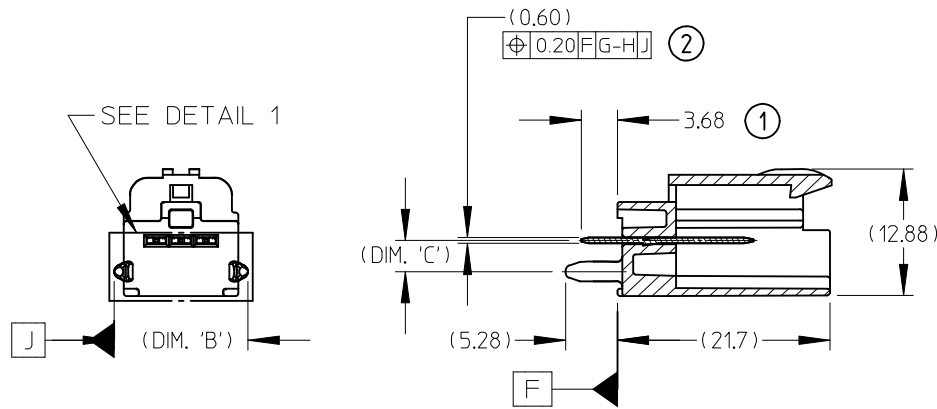
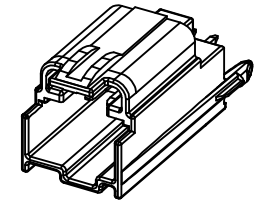
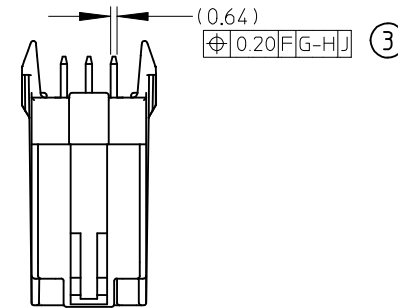

OPTION "A"

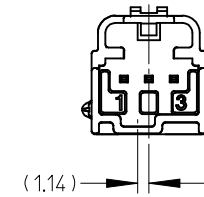

OPTION "B"  
VIEWED FROM MATE SIDE

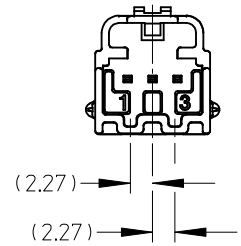

OPTION "C"

NOTES:

1. MATERIAL:  
HOUSING: SYNDIOTATIC POLYSTYRENE (SPS).  
COLOR: SEE CHART.  
TERMINAL: BRASS.
2. FINISH:  
TERMINAL: 60 MICROINCHES MIN NICKEL (Ni)  
UNDERPLATE OVERALL. 60 MICROINCHES MIN  
SELECTIVE TIN (Sn).
3. PRODUCT SPEC NUMBER PS-31100-0001.
4. PACKAGING PER PACKAGING SPEC.: PK-31300-293.
5. MATES WITH SEE CHART.

SECTION A-A

ENTER DESCRIPTION EC NO: UAU2009-0141 DRW:CD/ILLON 2008/09/15 CHKD:CD/ILLON 2008/09/15 APPR:SMARCEAU 2008/09/15	QUALITY SYMBOLS ▽=0 ▽7=0	GENERAL TOLERANCES (UNLESS SPECIFIED)		DIMENSION STYLE		SCALE	DESIGN UNITS	THIRD ANGLE PROJECTION			
				MM ONLY		2:1	METRIC				
				DRAWN BY DATE		DATE		TITLE VERTICAL HEADER ASSEMBLY CHARTED SALES DRAWING			
				MDEVITO 2/02/06		2/02/06					
		CHECKED BY DATE		DATE		MOLEX INCORPORATED DOCUMENT NO. SD-31206-003 SHEET NO. 1 OF 7					
		GMEYER 2/02/06		2/02/06							
		APPROVED BY DATE		DATE		THIS DRAWING CONTAINS INFORMATION THAT IS PROPRIETARY TO MOLEX INCORPORATED AND SHOULD NOT BE USED WITHOUT WRITTEN PERMISSION					
		GMEYER 2/02/06		2/02/06							
		MATERIAL NO.		SEE CHART							
		DRAFT WHERE APPLICABLE MUST REMAIN WITHIN DIMENSIONS		SIZE B							

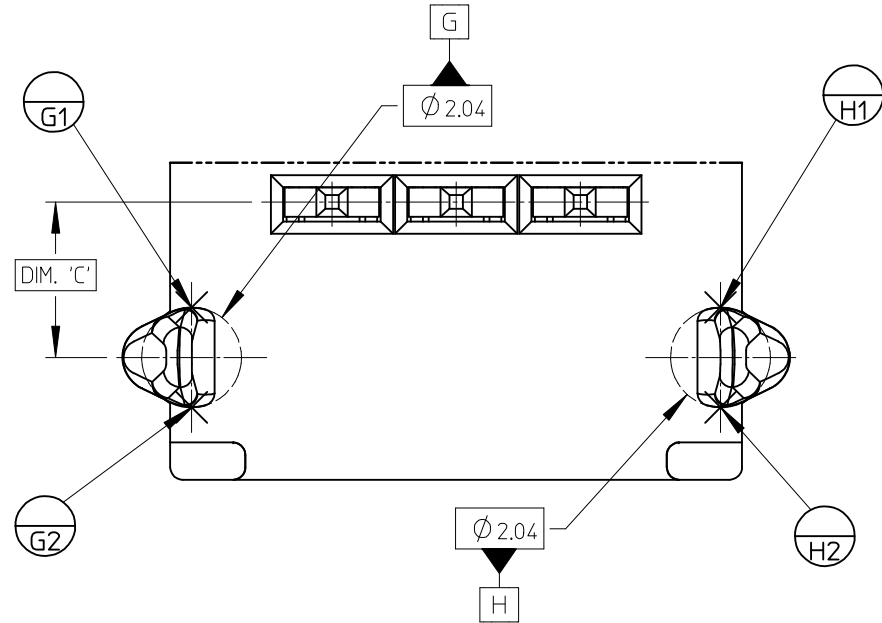

DETAIL 1  
SCALE 10:1

FULLY MATED ASSMBLY

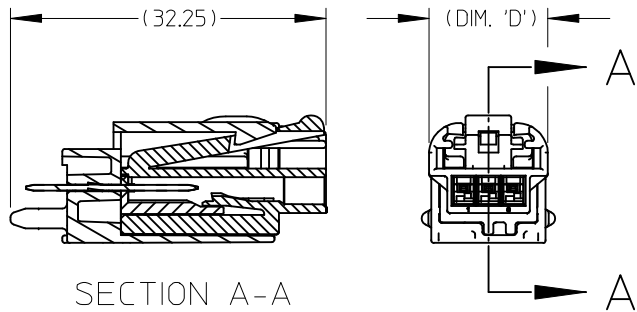

ENTER DESCRIPTION EC NO: UAU2009-0141 DRAWN: CDILLON 2008/09/15 CHKD: CDILLON 2008/09/15 APPR: SMARCEAU 2008/09/15	QUALITY SYMBOLS ▽=0 ▽=0	GENERAL TOLERANCES (UNLESS SPECIFIED)		DIMENSION STYLE MM ONLY		SCALE 1:1	DESIGN UNITS METRIC	THIRD ANGLE PROJECTION	
		4 PLACES ± --- ± --- 3 PLACES ± --- ± --- 2 PLACES ± 0.13 ± --- 1 PLACE ± 0.25 ± ---	mm INCH	DRAWN BY MDEVITO	DATE 2/02/06	TITLE VERTICAL HEADER ASSEMBLY CHARTED SALES DRAWING			
		ANGULAR ± 1/2°		CHECKED BY GMEYER	DATE 2/02/06	APPROVED BY GMEYER			
		DRAFT WHERE APPLICABLE MUST REMAIN WITHIN DIMENSIONS		MATERIAL NO. SEE CHART	DATE 2/02/06	MOLEX INCORPORATED		DOCUMENT NO. SD-31206-003	SHEET NO. 2 OF 7
THIS DRAWING CONTAINS INFORMATION THAT IS PROPRIETARY TO MOLEX INCORPORATED AND SHOULD NOT BE USED WITHOUT WRITTEN PERMISSION									

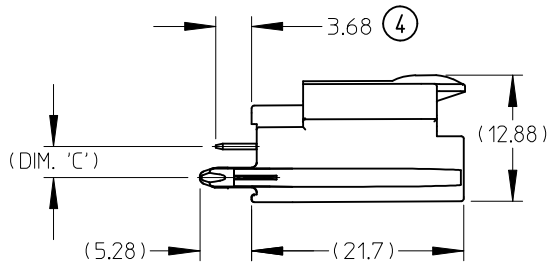

4 WAY VERTICAL  
HEADER ASSEMBLY  
(POLARIZATION OPTIONS)  
VIEWED FROM MATE SIDE

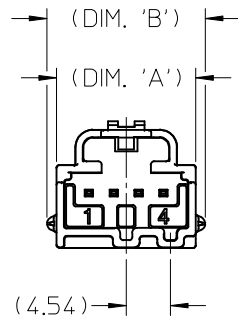

OPTION "A"

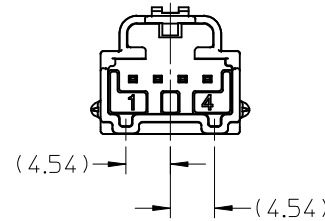

OPTION "B"  
VIEWED FROM MATE SIDE

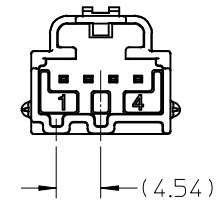

OPTION "C"

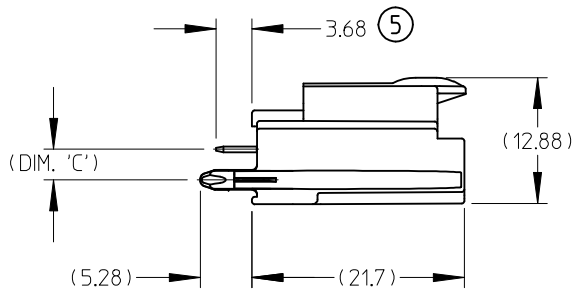
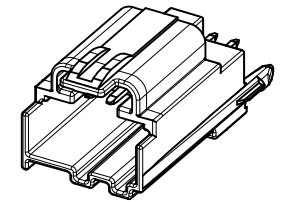

5 WAY VERTICAL  
HEADER ASSEMBLY  
(POLARIZATION OPTIONS)  
VIEWED FROM MATE SIDE

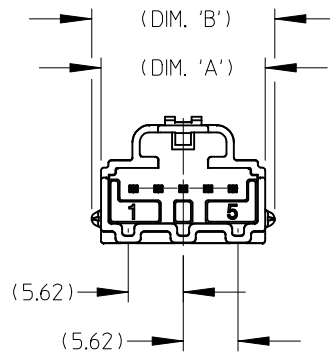

OPTION "A"

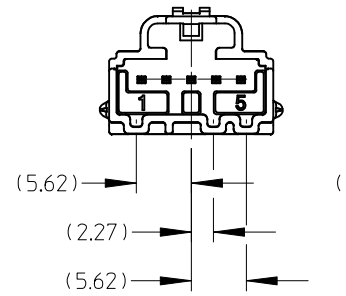

OPTION "B"  
VIEWED FROM MATE SIDE

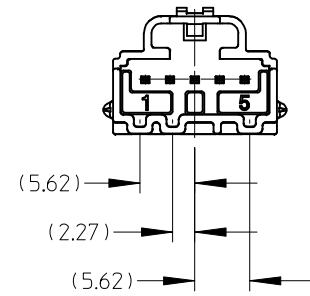

OPTION "C"

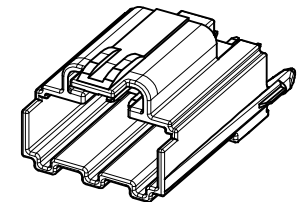

<b>ENTER DESCRIPTION</b> EC NO: UAU2009-0141 DRWN:CDILLON 2008/09/15 CHKD:CDILLON 2008/09/15 APPR:SMARCEAU 2008/09/15 H	<b>REVISION</b> DESCRIPTION REV	<b>QUALITY SYMBOLS</b> ▽=0 ▽=0	<b>GENERAL TOLERANCES (UNLESS SPECIFIED)</b>		<b>DIMENSION STYLE</b> MM ONLY		SCALE 1:1	DESIGN UNITS METRIC	THIRD ANGLE PROJECTION			
			4 PLACES ± --- ± ---	3 PLACES ± --- ± ---	DRAWN BY MDEVITO	DATE 2/02/06	TITLE VERTICAL HEADER ASSEMBLY CHARTED SALES DRAWING					
			2 PLACES ± 0.13 ± ---	1 PLACE ± 0.25 ± ---	CHECKED BY GMEYER	DATE 2/02/06	APPROVED BY GMEYER		DATE 2/02/06	MATERIAL NO.	DOCUMENT NO. SD-31206-003	SHEET NO. 3 OF 7
			ANGULAR ± 1/2°		DRAFT WHERE APPLICABLE MUST REMAIN WITHIN DIMENSIONS		SEE CHART		THIS DRAWING CONTAINS INFORMATION THAT IS PROPRIETARY TO MOLEX INCORPORATED AND SHOULD NOT BE USED WITHOUT WRITTEN PERMISSION			

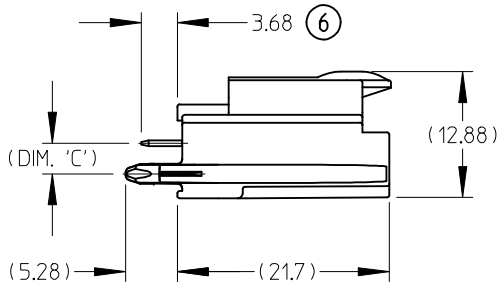

6 WAY VERTICAL  
HEADER ASSEMBLY  
(POLARIZATION OPTIONS)  
VIEWED FROM MATE SIDE

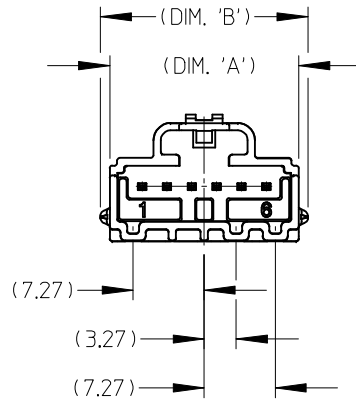

OPTION "A"

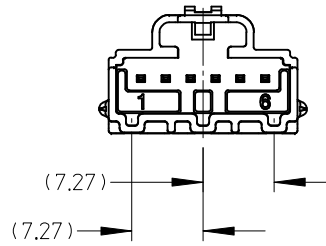

OPTION "B"  
VIEWED FROM MATE SIDE

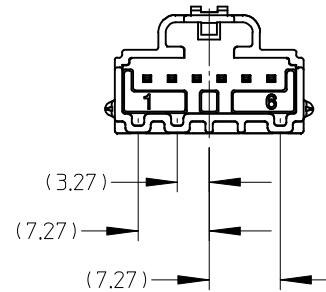

OPTION "C"

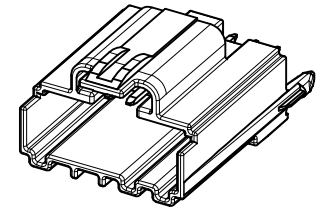

<b>ENTER DESCRIPTION</b> EC NO: UAU2009-0141 DRWN:CDILLON 2008/09/15 CHKD:CDILLON 2008/09/15 APPR:SMARCEAU 2008/09/15	<b>QUALITY SYMBOLS</b> ▽=0 ▽=0	<b>GENERAL TOLERANCES (UNLESS SPECIFIED)</b>		<b>DIMENSION STYLE</b> MM ONLY		SCALE 2:1	DESIGN UNITS METRIC	THIRD ANGLE PROJECTION		
		4 PLACES ± --- ± ---	mm INCH	DRAWN BY MDEVITO	DATE 2/02/06	TITLE VERTICAL HEADER ASSEMBLY CHARTED SALES DRAWING				
		3 PLACES ± --- ± ---	2 PLACES ± 0.13 ± ---	CHECKED BY GMEYER	DATE 2/02/06					
		1 PLACE ± 0.25 ± ---	ANGULAR ± 1/2°	APPROVED BY GMEYER	DATE 2/02/06	MATERIAL NO. SEE CHART		DOCUMENT NO. SD-31206-003	MOLEX INCORPORATED	
DRAFT WHERE APPLICABLE MUST REMAIN WITHIN DIMENSIONS		SIZE B		THIS DRAWING CONTAINS INFORMATION THAT IS PROPRIETARY TO MOLEX INCORPORATED AND SHOULD NOT BE USED WITHOUT WRITTEN PERMISSION					SHEET NO. 4 OF 7	

BILL OF MATERIALS

BILL OF MATERIALS

FEMALE MATING ASSEMBLY	HEADER ASSEMBLY PART NO.	DESCRIPTION	COLOR	DIM. 'A'	DIM. 'B'	DIM. 'C'	DIM. 'D'	FEMALE MATING ASSEMBLY	HEADER ASSEMBLY PART NO.	DESCRIPTION	COLOR	DIM. 'A'	DIM. 'B'	DIM. 'C'	DIM. 'D'
31067-1010	31101-0030 NOT TOOLED	3 WAY VERTICAL HEADER ASSEMBLY POLARIZATION "A"	BLACK	11.69	13.66	3.18	12.14	31072-1010	31101-0050 NOT TOOLED	5 WAY VERTICAL HEADER ASSEMBLY POLARIZATION "A"	BLACK	16.77	18.74	3.13	17.22
			N/A								N/A				
			GRAY								GRAY				
31067-1011	31101-0031 NOT TOOLED	3 WAY VERTICAL HEADER ASSEMBLY POLARIZATION "B"	GRAY	14.23	16.20	3.18	14.68	31073-1010	31101-0060 NOT TOOLED	6 WAY VERTICAL HEADER ASSEMBLY POLARIZATION "A"	BLACK	19.31	21.28	3.13	19.76
			N/A								N/A				
31067-1012	31101-0032 NOT TOOLED	3 WAY VERTICAL HEADER ASSEMBLY POLARIZATION "C"	BROWN	14.23	16.20	3.18	14.68	31073-1011	31101-0061 NOT TOOLED	6 WAY VERTICAL HEADER ASSEMBLY POLARIZATION "B"	GRAY	19.31	21.28	3.13	19.76
			N/A								N/A				
31068-1010	31101-0040	4 WAY VERTICAL HEADER ASSEMBLY POLARIZATION "A"	BLACK	14.23	16.20	3.18	14.68	31073-1012	31101-0062 NOT TOOLED	6 WAY VERTICAL HEADER ASSEMBLY POLARIZATION "C"	BROWN	19.31	21.28	3.13	19.76
			N/A								N/A				
31068-1011	31101-0041	4 WAY VERTICAL HEADER ASSEMBLY POLARIZATION "B"	GRAY	14.23	16.20	3.18	14.68	31073-1012	31101-0062 NOT TOOLED	6 WAY VERTICAL HEADER ASSEMBLY POLARIZATION "C"	BROWN	19.31	21.28	3.13	19.76
			N/A								N/A				
31068-1012	31101-0042	4 WAY VERTICAL HEADER ASSEMBLY POLARIZATION "C"	BROWN	14.23	16.20	3.18	14.68	31073-1012	31101-0062 NOT TOOLED	6 WAY VERTICAL HEADER ASSEMBLY POLARIZATION "C"	BROWN	19.31	21.28	3.13	19.76
			N/A								N/A				

<b>ENTER DESCRIPTION</b> EC NO: UAU2009-0141 DRWN:CDILLON 2008/09/15 CHKD:CDILLON 2008/09/15 APPR:SMARCEAU 2008/09/15 REV	QUALITY SYMBOLS ▽=0 ▽=0	GENERAL TOLERANCES (UNLESS SPECIFIED) mm INCH 4 PLACES ± --- ± --- 3 PLACES ± --- ± --- 2 PLACES ± 0.13 ± --- 1 PLACE ± 0.25 ± --- ANGULAR ± 1/2°	DIMENSION STYLE <b>MM ONLY</b> DRAWN BY DATE MDEVITO 2/02/06 CHECKED BY DATE GMEYER 2/02/06 APPROVED BY DATE GMEYER 2/02/06	SCALE <b>1:1</b> DESIGN UNITS <b>METRIC</b> THIRD ANGLE PROJECTION	TITLE <b>VERTICAL HEADER ASSEMBLY                  CHARTED SALES DRAWING</b>	
	DRAFT WHERE APPLICABLE MUST REMAIN WITHIN DIMENSIONS			MATERIAL NO. <b>SEE CHART</b>	DOCUMENT NO. <b>SD-31206-003</b>	SHEET NO. <b>5 OF 7</b>
	THIS DRAWING CONTAINS INFORMATION THAT IS PROPRIETARY TO MOLEX INCORPORATED AND SHOULD NOT BE USED WITHOUT WRITTEN PERMISSION					
	MOLEX INCORPORATED					
	Molex logo					

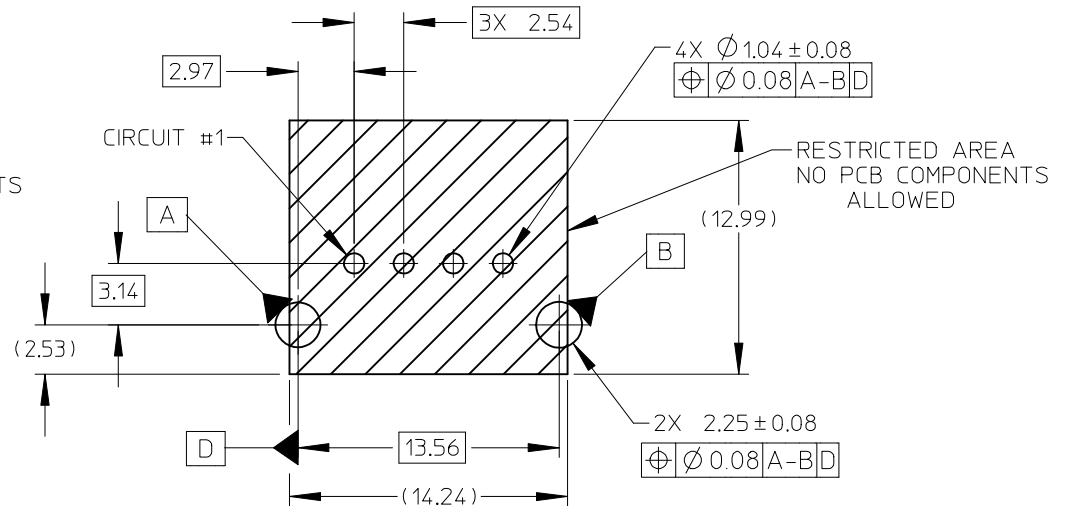
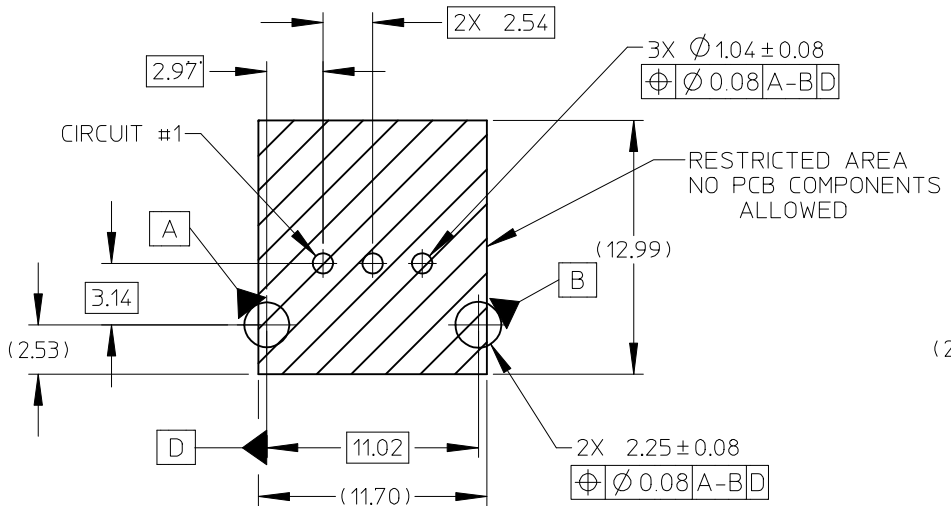

3 Way PCB LAYOUT COMPONENT SIDE  
RECOMENDED PCB THICKNESS 1.57±0.17

4 Way PCB LAYOUT COMPONENT SIDE  
RECOMENDED PCB THICKNESS 1.57±0.17

<b>ENTER DESCRIPTION</b> EC NO: UAU2009-0141 DRAWN: CDILLON 2008/09/15 CHKD: CDILLON 2008/09/15 APPR: SMARCEAU 2008/09/15	<b>QUALITY SYMBOLS</b> ▽=0 ▽=0	<b>GENERAL TOLERANCES (UNLESS SPECIFIED)</b>		<b>DIMENSION STYLE</b> MM ONLY		SCALE	DESIGN UNITS METRIC	THIRD ANGLE PROJECTION		
		4 PLACES ± --- ± ---	mm INCH	DRAWN BY MDEVITO	DATE 2/02/06	TITLE VERTICAL HEADER ASSEMBLY CHARTED SALES DRAWING		MOLEX INCORPORATED		
		3 PLACES ± --- ± ---		CHECKED BY GMEYER	DATE 2/02/06	MATERIAL NO. SEE CHART				
		2 PLACES ± 0.13 ± ---		APPROVED BY GMEYER		DATE 2/02/06	THIS DRAWING CONTAINS INFORMATION THAT IS PROPRIETARY TO MOLEX INCORPORATED AND SHOULD NOT BE USED WITHOUT WRITTEN PERMISSION			
1 PLACE ± 0.25 ± ---		ANGULAR ±1/2°								
DRAFT WHERE APPLICABLE MUST REMAIN WITHIN DIMENSIONS										



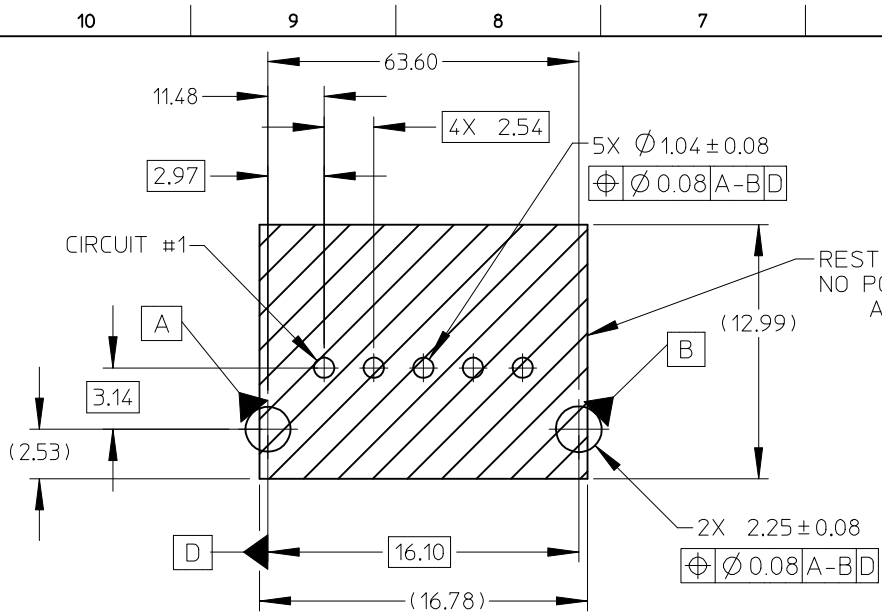

5 WAY PCB LAYOUT COMPONENT SIDE  
RECOMENDED PCB THICKNESS 1.57±0.17

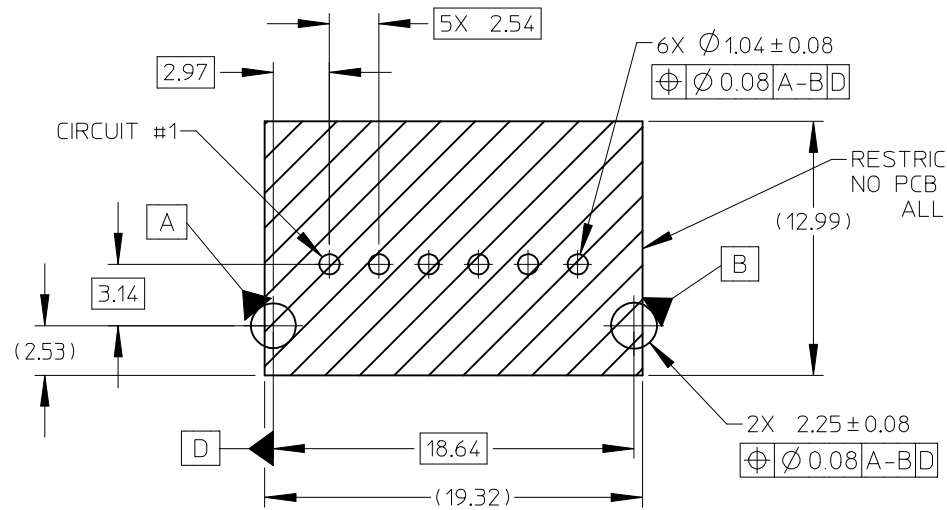

6 WAY PCB LAYOUT COMPONENT SIDE  
RECOMENDED PCB THICKNESS 1.57±0.17

<b>ENTER DESCRIPTION</b> EC NO: UAU2009-0141 DRAWN: COILLON 2008/09/15 CHKD: COILLON 2008/09/15 APPR: SMARCEAU 2008/09/15	<b>QUALITY SYMBOLS</b> ▽=0 ▽=0	<b>GENERAL TOLERANCES (UNLESS SPECIFIED)</b>		<b>DIMENSION STYLE</b> MM ONLY		SCALE 1:1	DESIGN UNITS METRIC	THIRD ANGLE PROJECTION		
		mm	INCH	DRAWN BY	DATE	TITLE <b>VERTICAL HEADER ASSEMBLY CHARTED SALES DRAWING</b>				
		4 PLACES ± ---	± ---	MDEVITO	2/02/06					
		3 PLACES ± ---	± ---	CHECKED BY	DATE	MOLEX INCORPORATED				
2 PLACES ± 0.13	± ---	GMEYER	2/02/06							
1 PLACE ± 0.25	± ---	APPROVED BY	DATE	DOCUMENT NO. SD-31206-003						
ANGULAR ± 1/2°		GMEYER	2/02/06							
DRAFT WHERE APPLICABLE MUST REMAIN WITHIN DIMENSIONS		MATERIAL NO. SEE CHART		SHEET NO. 7 OF 7		THIS DRAWING CONTAINS INFORMATION THAT IS PROPRIETARY TO MOLEX INCORPORATED AND SHOULD NOT BE USED WITHOUT WRITTEN PERMISSION				