

**DC - 20 GHz Discrete power pHEMT**

**TGF2022-06**

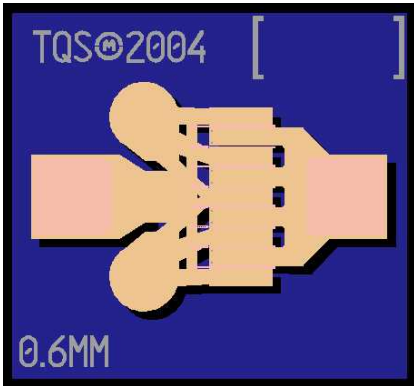

**Product Description**

The TriQuint TGF2022-06 is a discrete 0.6 mm pHEMT which operates from DC-20 GHz. The TGF2022-06 is designed using TriQuint’s proven standard 0.35um power pHEMT production process.

The TGF2022-06 typically provides > 28 dBm of saturated output power with power gain of 13 dB. The maximum power added efficiency is 58% which makes the TGF2022-06 appropriate for high efficiency applications.

The TGF2022-06 is also ideally suited for Point-to-point Radio, High-reliability space, and Military applications.

The TGF2022-06 has a protective surface passivation layer providing environmental robustness.

Lead-free and RoHS compliant

**Key Features and Performance**

- Frequency Range: DC - 20 GHz
- > 28 dBm Nominal Psat
- 58% Maximum PAE
- 36 dBm Nominal OIP3
- 13 dB Nominal Power Gain
- Suitable for high reliability applications
- 0.6mm x 0.35um Power pHEMT
- Nominal Bias Vd = 8-12V, Idq = 45-75mA (Under RF Drive, Id rises from 45mA to 150mA)
- Chip Dimensions: 0.57 x 0.53 x 0.10 mm (0.022 x 0.021 x 0.004 in)

**Primary Applications**

- Point-to-point Radio
- High-reliability space
- Military
- Base Stations
- Broadband Wireless Applications

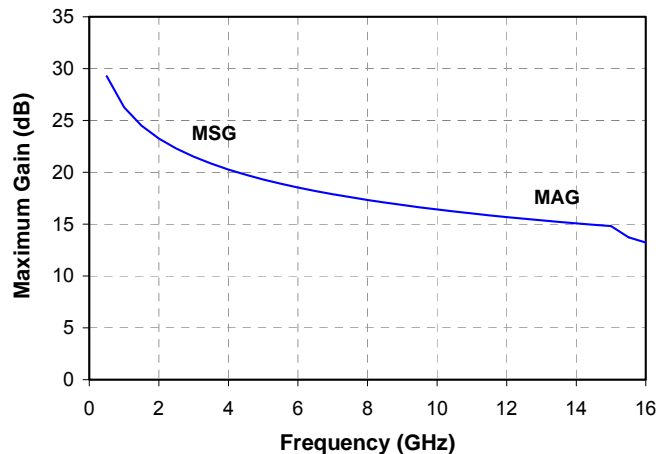

**TABLE I  
 MAXIMUM RATINGS**
**TGF2022-06**

Symbol	Parameter <u>1/</u>	Value	Notes
V <sup>+</sup>	Positive Supply Voltage	12.5 V	<u>2/</u>
V <sup>-</sup>	Negative Supply Voltage Range	-5V to 0V	
I <sup>+</sup>	Positive Supply Current	282 mA	<u>2/</u>
I <sub>G</sub>	Gate Supply Current	7 mA	
P <sub>IN</sub>	Input Continuous Wave Power	23 dBm	<u>2/</u>
P <sub>D</sub>	Power Dissipation	See note 3	<u>2/ 3/</u>
T <sub>CH</sub>	Operating Channel Temperature	150 °C	<u>4/</u>
T <sub>M</sub>	Mounting Temperature (30 Seconds)	320 °C	
T <sub>STG</sub>	Storage Temperature	-65 to 150 °C	

- 1/ These ratings represent the maximum operable values for this device.
- 2/ Combinations of supply voltage, supply current, input power, and output power shall not exceed P<sub>D</sub>.
- 3/ For a median life time of 1E+6 hrs, Power dissipation is limited to:  

$$P_{D(max)} = (150\text{ °C} - T_{BASE}\text{ °C}) / 138.0\text{ (°C/W)}$$
- 4/ Junction operating temperature will directly affect the device median time to failure (T<sub>M</sub>). For maximum life, it is recommended that junction temperatures be maintained at the lowest possible levels.

**TABLE II  
 DC PROBE CHARACTERISTICS  
 (T<sub>A</sub> = 25 °C, Nominal)**

Symbol	Parameter	Minimum	Typical	Maximum	Unit
I <sub>DSS</sub>	Saturated Drain Current	-	180	-	mA
G <sub>m</sub>	Transconductance	-	225	-	mS
V <sub>P</sub>	Pinch-off Voltage	-1.5	-1	-0.5	V
V <sub>BGS</sub>	Breakdown Voltage Gate-Source	-30	-	-8	V
V <sub>BGD</sub>	Breakdown Voltage Gate-Drain	-30	-	-14	V

Note: For TriQuint's 0.35um power pHEMT devices, RF breakdown &gt;&gt; DC breakdown

**TABLE III**  
**RF CHARACTERIZATION TABLE 1/**  
 (T<sub>A</sub> = 25 °C, Nominal)

SYMBOL	PARAMETER	f = 10 GHz		f = 18 GHz		UNITS
		Vd = 10V Idq = 45 mA	Vd = 12V Idq = 45 mA	Vd = 10V Idq = 45 mA	Vd = 12V Idq = 45 mA	
<b>Power Tuned:</b>						
Psat	Saturated Output Power	28.9	29.6	28.1	28.7	dBm
PAE	Power Added Efficiency	52.4	51.9	41.5	37.0	%
Gain	Power Gain	12.9	12.9	8.3	8.0	dB
$\Gamma_L$ <u>2/</u>	Load Reflection coefficient	0.379 $\angle$ 120.6	0.4 $\angle$ 104.5	0.525 $\angle$ 128.9	0.562 $\angle$ 125.7	-
<b>Efficiency Tuned:</b>						
Psat	Saturated Output Power	28.3	29.3	27.5	28.1	dBm
PAE	Power Added Efficiency	58.3	56.0	46.0	42.5	%
Gain	Power Gain	13	13	8.5	8.3	dB
$\Gamma_L$ <u>2/</u>	Load Reflection coefficient	0.454 $\angle$ 94.2	0.465 $\angle$ 93.4	0.62 $\angle$ 126.9	0.673 $\angle$ 124.1	-
OIP3	Output TOI	37	36	37	36	dBm

1/ Large signal equivalent pHEMT output network

2/ Optimum load impedance for maximum power or maximum PAE at 10 and 18 GHz. The series resistance and inductance (R<sub>d</sub> and L<sub>d</sub>) shown in the Figure on page 7 is excluded

**TABLE IV**  
**THERMAL INFORMATION**

Parameter	Test Conditions	T <sub>CH</sub> (°C)	θ <sub>JC</sub> (°C/W)	T <sub>M</sub> (HRS)
θ <sub>JC</sub> Thermal Resistance (channel to backside of carrier)	Vd = 12 V Idq = 45 mA Pdiss = 0.54 W	145	138	1.6 E+6

Note: Assumes eutectic attach using 1.5 mil 80/20 AuSn mounted to a 20 mil CuMo Carrier at 70°C baseplate temperature.

**Measured Fixtured Data**

IMD3 vs. output power/tone at 10 & 18 GHz

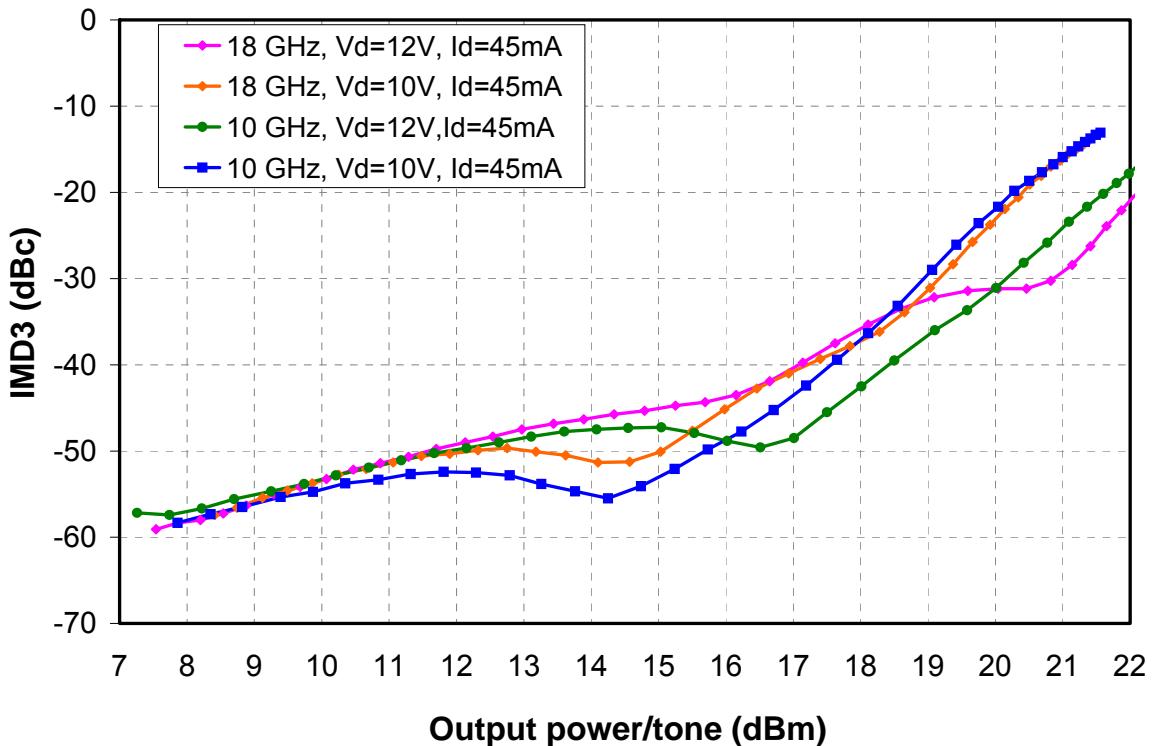

**Measured Fixtured Data**

Power tuned data at 10GHz

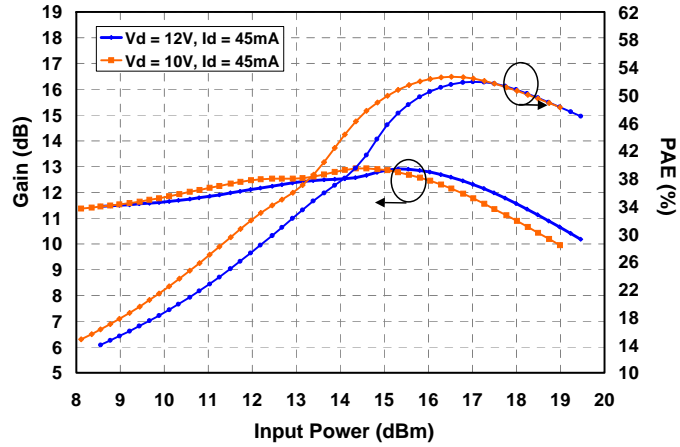
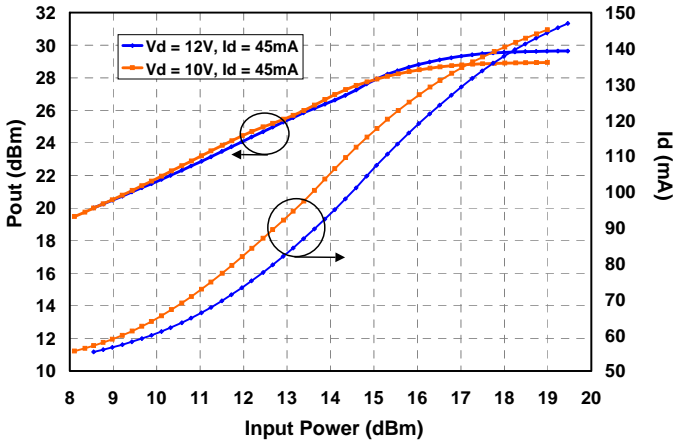

**For power tuned devices at 10GHz**  
 Input matched for maximum gain & output load is:  
 Vd=12V, Idq=45mA:  $R_p = 57.0 \Omega$ ,  $C_p = 0.257\text{pF}$ ,  $\Gamma = 0.400$ ,  $\theta = 104.7^\circ$   
 Vd=10V, Idq=75mA:  $R_p = 44.6 \Omega$ ,  $C_p = 0.276\text{pF}$ ,  $\Gamma = 0.382$ ,  $\theta = 120.1^\circ$

Efficiency tuned data at 10GHz

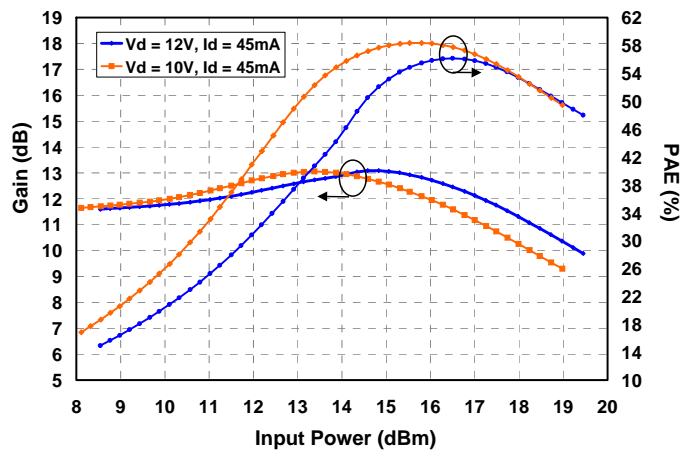
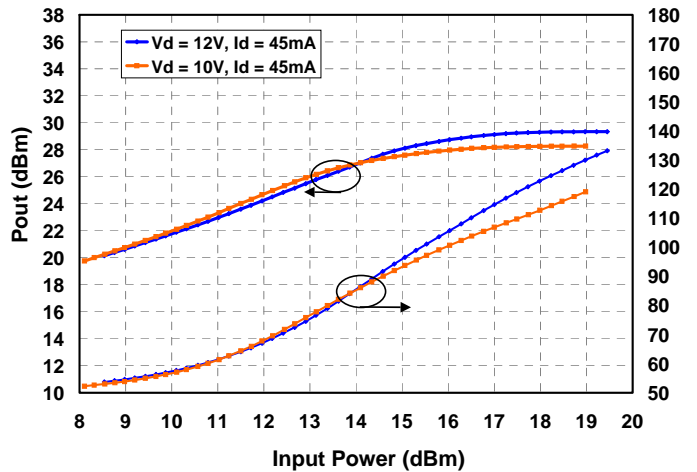

**For efficiency tuned devices at 10GHz:**  
 Input matched for maximum gain & output load is:  
 Vd=12V, Idq=45mA:  $R_p = 74.2 \Omega$ ,  $C_p = 0.255\text{pF}$ ,  $\Gamma = 0.466$ ,  $\theta = 93.4^\circ$   
 Vd=10V, Idq=45mA:  $R_p = 72.5 \Omega$ ,  $C_p = 0.252\text{pF}$ ,  $\Gamma = 0.455$ ,  $\theta = 93.7^\circ$

**Measured Fixtured Data**

Power tuned data at 18GHz

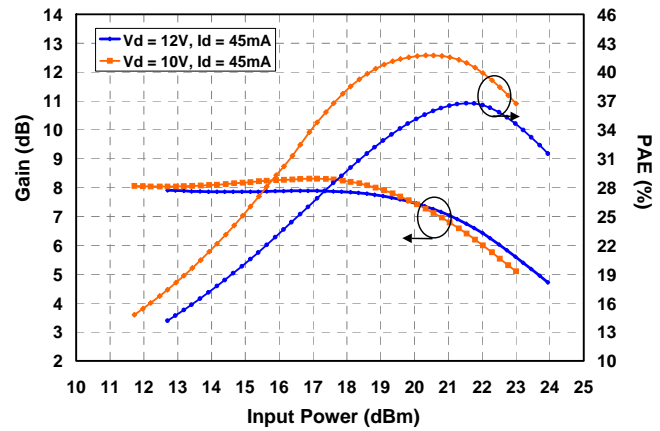
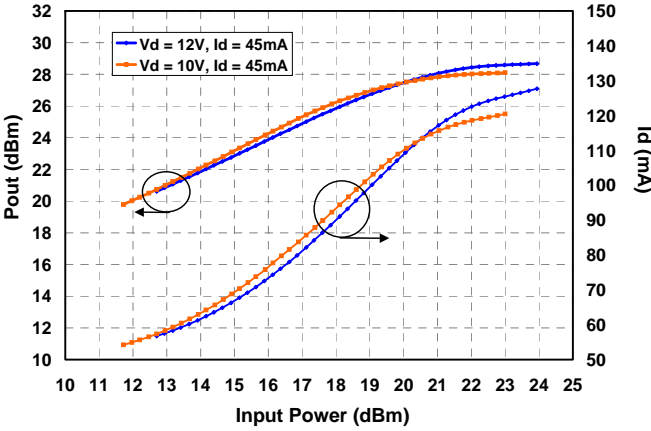

**For power tuned devices at 18GHz**  
 Input matched for maximum gain & output load is:  
 Vd=12V, Idq=45mA:  $R_p = 48.4 \Omega$ ,  $C_p = 0.432\text{pF}$ ,  $\Gamma = 0.556$ ,  $\theta = 125.1^\circ$   
 Vd=10V, Idq=75mA:  $R_p = 43.5 \Omega$ ,  $C_p = 0.415\text{pF}$ ,  $\Gamma = 0.522$ ,  $\theta = 127.7^\circ$

Efficiency tuned data at 18GHz

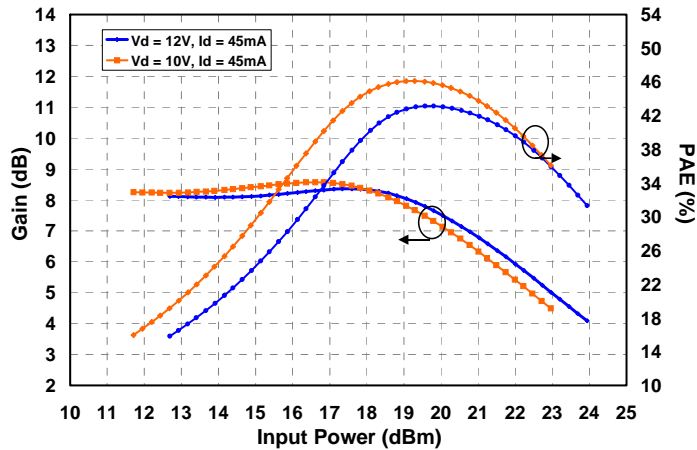
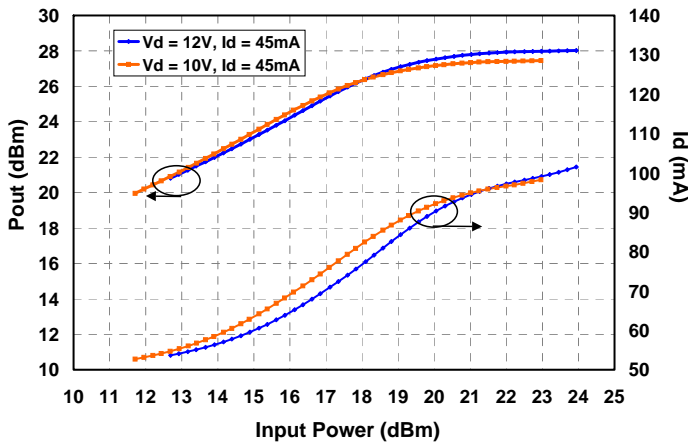

**For efficiency tuned devices at 18GHz:**  
 Input matched for maximum gain & output load is:  
 Vd=12V, Idq=45mA:  $R_p = 67.0 \Omega$ ,  $C_p = 0.503\text{pF}$ ,  $\Gamma = 0.680$ ,  $\theta = 123.0^\circ$   
 Vd=10V, Idq=45mA:  $R_p = 51.3 \Omega$ ,  $C_p = 0.495\text{pF}$ ,  $\Gamma = 0.619$ ,  $\theta = 127.3^\circ$

**Linear Model for 0.6 mm Unit pHEMT cell**

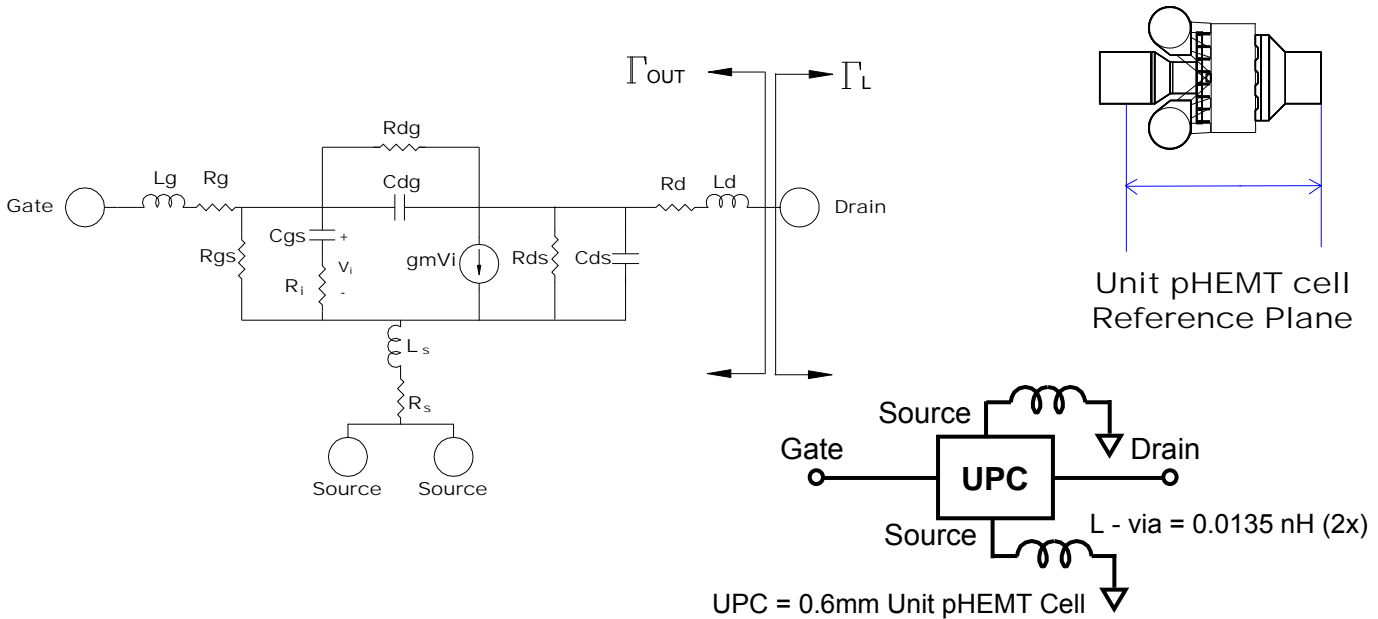

MODEL PARAMETER	Vd = 8V Idq = 45mA	Vd = 8V Idq = 60mA	Vd = 8V Idq = 75mA	Vd = 10V Idq = 45mA	Vd = 10V Idq = 60mA	Vd = 12V Idq = 45mA	UNITS
Rg	0.22	0.23	0.24	0.23	0.24	0.24	Ω
Rs	0.40	0.41	0.41	0.46	0.45	0.50	Ω
Rd	0.51	0.52	0.52	0.50	0.50	0.48	Ω
gm	0.195	0.202	0.202	0.188	0.195	0.183	S
Cgs	1.50	1.63	1.70	1.64	1.73	1.71	pF
Ri	1.65	1.59	1.58	1.72	1.64	1.73	Ω
Cds	0.115	0.115	0.116	0.114	0.115	0.114	pF
Rds	243.14	247.08	255.12	278.72	279.31	302.49	Ω
Cgd	0.072	0.066	0.063	0.064	0.061	0.060	pF
Tau	5.94	6.23	6.51	6.85	6.95	7.36	pS
Ls	0.001	0.001	0.001	0.001	0.001	0.001	nH
Lg	0.108	0.108	0.108	0.108	0.108	0.108	nH
Ld	0.121	0.120	0.118	0.118	0.118	0.117	nH
Rgs	5110	5140	8310	5110	5420	5120	Ω
Rgd	57700	64800	74400	79400	82900	82300	Ω

**Unmatched S-parameters for 0.6 mm pHEMT**

**Bias Conditions: Vd = 12V, Idq = 45mA**

Frequency (GHz)	s11 dB	s11 ang deg	s21 dB	s21 ang deg	s12 dB	s12 ang deg	s22 dB	s22 ang deg
0.5	-0.241	-36.34	22.678	159.08	-35.863	70.86	-2.990	-12.01
1	-0.419	-66.76	21.503	141.50	-31.020	55.18	-3.802	-21.21
1.5	-0.587	-89.70	20.058	128.01	-28.948	43.57	-4.700	-27.22
2	-0.712	-106.49	18.609	117.76	-27.903	35.20	-5.480	-31.06
2.5	-0.798	-118.92	17.260	109.77	-27.322	29.07	-6.093	-33.71
3	-0.857	-128.35	16.035	103.28	-26.972	24.45	-6.554	-35.80
3.5	-0.898	-135.70	14.930	97.82	-26.750	20.86	-6.896	-37.68
4	-0.928	-141.60	13.930	93.08	-26.602	17.99	-7.146	-39.51
4.5	-0.949	-146.44	13.022	88.85	-26.501	15.64	-7.327	-41.37
5	-0.964	-150.49	12.193	85.01	-26.430	13.67	-7.457	-43.31
5.5	-0.976	-153.95	11.432	81.46	-26.380	11.99	-7.547	-45.31
6	-0.985	-156.94	10.730	78.12	-26.345	10.54	-7.606	-47.40
6.5	-0.992	-159.58	10.079	74.97	-26.321	9.26	-7.641	-49.54
7	-0.997	-161.92	9.473	71.95	-26.305	8.13	-7.657	-51.75
7.5	-1.001	-164.03	8.905	69.05	-26.295	7.11	-7.657	-54.01
8	-1.004	-165.94	8.373	66.25	-26.290	6.19	-7.643	-56.31
8.5	-1.007	-167.69	7.872	63.52	-26.290	5.35	-7.618	-58.64
9	-1.008	-169.30	7.399	60.86	-26.293	4.59	-7.584	-61.01
9.5	-1.010	-170.80	6.950	58.25	-26.298	3.88	-7.541	-63.39
10	-1.010	-172.20	6.524	55.69	-26.307	3.22	-7.491	-65.79
10.5	-1.011	-173.52	6.119	53.18	-26.317	2.61	-7.435	-68.21
11	-1.011	-174.76	5.733	50.70	-26.328	2.04	-7.373	-70.63
11.5	-1.011	-175.94	5.363	48.25	-26.342	1.51	-7.306	-73.06
12	-1.010	-177.06	5.010	45.84	-26.357	1.01	-7.234	-75.49
12.5	-1.010	-178.13	4.670	43.44	-26.373	0.53	-7.158	-77.92
13	-1.009	-179.15	4.344	41.07	-26.390	0.09	-7.078	-80.35
13.5	-1.008	-179.86	4.031	38.72	-26.408	-0.33	-6.995	-82.78
14	-1.007	-178.91	3.728	36.39	-26.426	-0.72	-6.909	-85.19
14.5	-1.006	-177.99	3.436	34.07	-26.446	-1.10	-6.819	-87.60
15	-1.004	-177.10	3.154	31.77	-26.466	-1.45	-6.728	-90.00
15.5	-1.003	-176.24	2.881	29.49	-26.486	-1.79	-6.633	-92.39
16	-1.001	-175.40	2.616	27.21	-26.507	-2.10	-6.537	-94.76
16.5	-0.999	-174.58	2.359	24.95	-26.529	-2.40	-6.439	-97.13
17	-0.998	-173.79	2.109	22.70	-26.551	-2.69	-6.339	-99.48
17.5	-0.996	-173.01	1.866	20.46	-26.572	-2.95	-6.238	-101.81
18	-0.994	-172.24	1.629	18.23	-26.595	-3.21	-6.135	-104.13
18.5	-0.992	-171.50	1.398	16.01	-26.617	-3.45	-6.031	-106.44
19	-0.989	-170.76	1.173	13.79	-26.639	-3.67	-5.926	-108.72
19.5	-0.987	-170.04	0.953	11.58	-26.661	-3.88	-5.820	-111.00
20	-0.985	-169.34	0.737	9.38	-26.683	-4.08	-5.713	-113.25
20.5	-0.982	-168.64	0.526	7.19	-26.705	-4.27	-5.606	-115.49
21	-0.980	-167.96	0.319	5.00	-26.726	-4.45	-5.498	-117.71
21.5	-0.977	-167.28	0.115	2.82	-26.748	-4.61	-5.390	-119.91
22	-0.975	-166.61	-0.085	0.64	-26.769	-4.77	-5.281	-122.09
22.5	-0.972	-165.96	-0.281	-1.53	-26.789	-4.91	-5.173	-124.26
23	-0.970	-165.31	-0.475	-3.69	-26.809	-5.04	-5.064	-126.41
23.5	-0.967	-164.67	-0.666	-5.85	-26.829	-5.17	-4.956	-128.54
24	-0.964	-164.03	-0.854	-8.01	-26.848	-5.29	-4.848	-130.65
24.5	-0.961	-163.41	-1.040	-10.16	-26.866	-5.39	-4.740	-132.75
25	-0.958	-162.79	-1.224	-12.31	-26.884	-5.49	-4.632	-134.82
25.5	-0.955	-162.18	-1.406	-14.45	-26.901	-5.58	-4.525	-136.88
26	-0.952	-161.57	-1.586	-16.59	-26.917	-5.67	-4.419	-138.92



**Mechanical Drawing**

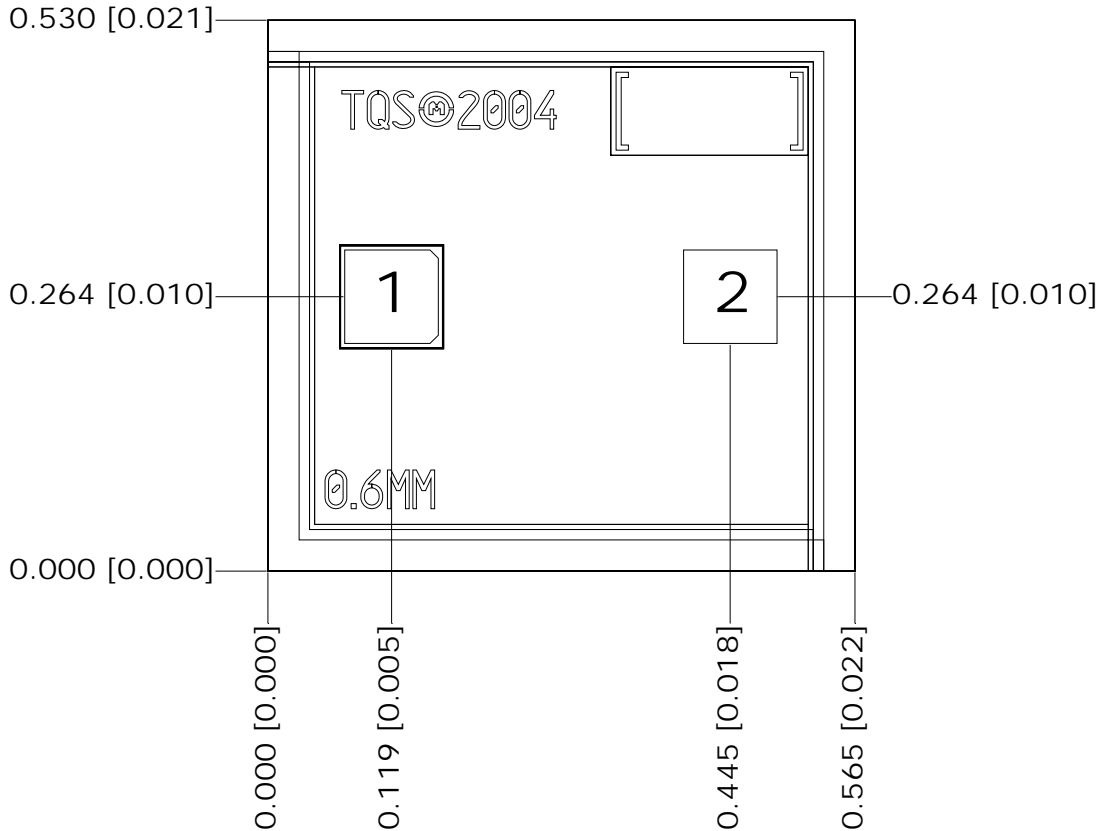

Units: millimeters (inches)

Thickness: 0.100 (0.004)

Chip edge to bond pad dimensions are shown to center of bond pad

Chip size tolerance: +/- 0.051 (0.002)

GND IS BACKSIDE OF MMIC

Bond pad #1 (Vg) 0.090 x 0.090 (0.004 x 0.004)

Bond pad #2 (Vd) 0.090 x 0.090 (0.004 x 0.004)

*GaAs MMIC devices are susceptible to damage from Electrostatic Discharge. Proper precautions should be observed during handling, assembly and test.*

## **Assembly Process Notes**

### Reflow process assembly notes:

- Use AuSn (80/20) solder with limited exposure to temperatures at or above 300 °C for 30 sec
- An alloy station or conveyor furnace with reducing atmosphere should be used.
- No fluxes should be utilized.
- Coefficient of thermal expansion matching is critical for long-term reliability.
- Devices must be stored in a dry nitrogen atmosphere.

### Component placement and adhesive attachment assembly notes:

- Vacuum pencils and/or vacuum collets are the preferred method of pick up.
- Air bridges must be avoided during placement.
- The force impact is critical during auto placement.
- Organic attachment can be used in low-power applications.
- Curing should be done in a convection oven; proper exhaust is a safety concern.
- Microwave or radiant curing should not be used because of differential heating.
- Coefficient of thermal expansion matching is critical.

### Interconnect process assembly notes:

- Thermosonic ball bonding is the preferred interconnect technique.
- Force, time, and ultrasonics are critical parameters.
- Aluminum wire should not be used.
- Devices with small pad sizes should be bonded with 0.0007-inch wire.
- Maximum stage temperature is 200 °C.