

200Volt, 0.40Ω, MEGA RAD HARD HEXFET

International Rectifier's MEGA RAD HARD technology HEXFETs demonstrate virtual immunity to SEE failure. Additionally, under **identical** pre- and post-radiation test conditions, International Rectifier's RAD HARD HEXFETs retain **identical** electrical specifications up to 1×10^5 Rads (Si) total dose. No compensation in gate drive circuitry is required. These devices are also capable of surviving transient ionization pulses as high as 1×10^{12} Rads (Si)/Sec, and return to normal operation within a few microseconds. Since the RAD HARD process utilizes International Rectifier's patented HEXFET technology, the user can expect the highest quality and reliability in the industry.

RAD HARD HEXFET transistors also feature all of the well-established advantages of MOSFETs, such as voltage control, very fast switching, ease of paralleling and temperature stability of the electrical parameters. They are well-suited for applications such as switching power supplies, motor controls, inverters, choppers, audio amplifiers and high-energy pulse circuits in space and weapons environments.

Product Summary

Part Number	BV _{DSS}	R _{DS(on)}	I _D
IRHY7230CM	200V	0.40Ω	9.4A
IRHY8230CM	200V	0.40Ω	9.4A

Features:

- Radiation Hardened up to 1×10^6 Rads (Si)
- Single Event Burnout (SEB) Hardened
- Single Event Gate Rupture (SEGR) Hardened
- Gamma Dot (Flash X-Ray) Hardened
- Neutron Tolerant
- Identical Pre- and Post-Electrical Test Conditions
- Avalanche Energy Rating
- Dynamic dv/dt Rating
- Simple Drive Requirements
- Ease of Paralleling
- Hermetically Sealed
- Electrically Isolated
- Ceramic Eyelets

Absolute Maximum Ratings

Pre-Radiation

	Parameter	IRHY7230CM, IRHY8230CM	Units
I _D @ V _{GS} = 12V, T _C = 25°C	Continuous Drain Current	9.4	A
I _D @ V _{GS} = 12V, T _C = 100°C	Continuous Drain Current	6.0	
I _{DM}	Pulsed Drain Current ①	37	
P _D @ T _C = 25°C	Max. Power Dissipation	75	W
	Linear Derating Factor	0.6	W/K ⑤
V _{GS}	Gate-to-Source Voltage	±20	V
EAS	Single Pulse Avalanche Energy ②	150	mJ
I _{AR}	Avalanche Current ①	5.5	A
EAR	Repetitive Avalanche Energy ①	7.5	mJ
dv/dt	Peak Diode Recovery dv/dt ③	16	V/ns
T _J	Operating Junction	-55 to 150	°C
T _{STG}	Storage Temperature Range		
	Lead Temperature 300 (0.063 in. (1.6mm) from case for 10s)		
	Weight	7.0(typical)	g

Electrical Characteristics @ T_j = 25°C (Unless Otherwise Specified)

	Parameter	Min	Typ	Max	Units	Test Conditions
BV _{DSS}	Drain-to-Source Breakdown Voltage	200	—	—	V	V _{GS} = 0 V, I _D = 1.0mA
ΔBV _{DSS} /ΔT _J	Temperature Coefficient of Breakdown Voltage	—	0.23	—	V/°C	Reference to 25°C, I _D = 1.0mA
R _{DS(on)}	Static Drain-to-Source On-State Resistance	—	—	0.40	Ω	V _{GS} = 12V, I _D = 6.0A ④
		—	—	0.49		V _{GS} = 12V, I _D = 9.4A
V _{GS(th)}	Gate Threshold Voltage	2.0	—	4.0	V	V _{DS} = V _{GS} , I _D = 1.0mA
g _{fs}	Forward Transconductance	2.5	—	—	S (τ)	V _{DS} > 15V, I _{DS} = 6.0A ④
I _{DSS}	Zero Gate Voltage Drain Current	—	—	25	μA	V _{DS} = 0.8 x Max Rating, V _{GS} = 0V
		—	—	250		V _{DS} = 0.8 x Max Rating V _{GS} = 0V, T _J = 125°C
I _{GSS}	Gate-to-Source Leakage Forward	—	—	100	nA	V _{GS} = 20V
I _{GSS}	Gate-to-Source Leakage Reverse	—	—	-100		V _{GS} = -20V
Q _g	Total Gate Charge	—	—	50	nC	V _{GS} = 12V, I _D = 9.4A
Q _{gs}	Gate-to-Source Charge	—	—	10		V _{DS} = Max Rating x 0.5
Q _{gd}	Gate-to-Drain ('Miller') Charge	—	—	25		
t _{d(on)}	Turn-On Delay Time	—	—	35	ns	V _{DD} = 100V, I _D = 9.4A, R _G = 7.5Ω
t _r	Rise Time	—	—	75		
t _{d(off)}	Turn-Off Delay Time	—	—	70		
t _f	Fall Time	—	—	60		
L _D	Internal Drain Inductance	—	8.7	—	nH	Measured from drain lead, 6mm (0.25 in) from package to center of die.
L _S	Internal Source Inductance	—	8.7	—		Measured from source lead, 6mm (0.25 in) from package to source bonding pad.
C _{iss}	Input Capacitance	—	1200	—	pF	V _{GS} = 0V, V _{DS} = 25V f = 1.0MHz
C _{oss}	Output Capacitance	—	250	—		
C _{rss}	Reverse Transfer Capacitance	—	63	—		

Source-Drain Diode Ratings and Characteristics

	Parameter	Min	Typ	Max	Units	Test Conditions
I _S	Continuous Source Current (Body Diode)	—	—	9.4	A	Modified MOSFET symbol showing the integral reverse pn junction rectifier.
I _{SM}	Pulse Source Current (Body Diode) ①	—	—	37		
V _{SD}	Diode Forward Voltage	—	—	1.4	V	T _J = 25°C, I _S = 9.4A, V _{GS} = 0V ④
t _{rr}	Reverse Recovery Time	—	—	460	ns	T _J = 25°C, I _F = 9.4A, di/dt ≤ 100A/μs
Q _{RR}	Reverse Recovery Charge	—	—	2.4	μC	V _{DD} ≤ 50V ④
t _{on}	Forward Turn-On Time	Intrinsic turn-on time is negligible. Turn-on speed is substantially controlled by L _S + L _D .				

Thermal Resistance

	Parameter	Min	Typ	Max	Units	Test Conditions
R _{thJC}	Junction-to-Case	—	—	1.67	K/W ⑤	
R _{thJA}	Junction-to-Ambient	—	—	80		Typical socket mount

Radiation Performance of Rad Hard HEXFETs

International Rectifier Radiation Hardened HEXFETs are tested to verify their hardness capability. The hardness assurance program at International Rectifier uses two radiation environments.

Every manufacturing lot is tested in a low dose rate (total dose) environment per MIL-STD-750, test method 1019. International Rectifier has imposed a standard gate voltage of 12 volts per note 6 and a V_{DSS} bias condition equal to 80% of the device rated voltage per note 7. Pre- and post-radiation limits of the devices irradiated to 1×10^5 Rads (Si) are identical

and are presented in Table 1, column 1, IRHY7230CM. The values in Table 1 will be met for either of the two low dose rate test circuits that are used. Both pre- and post-radiation performance are tested and specified using the same drive circuitry and test conditions in order to provide a direct comparison. It should be noted that at a radiation level of 1×10^5 Rads (Si) no changes in limits are specified in DC parameters.

High dose rate testing may be done on a special request basis using a dose rate up to 1×10^{12} Rads (Si)/Sec.

International Rectifier radiation hardened HEXFETs have been characterized in neutron and heavy ion Single Event Effects (SEE) environments. Single Event Effects characterization is shown in Table 3.

Table 1. Low Dose Rate ⑥ ⑦

Parameter	Description	IRHY7230CM		IRHY8230CM		Units	Test Conditions ⑩
		100K Rads (Si)		1000K Rads (Si)			
		Min	Max	Min	Max		
BV_{DSS}	Drain-to-Source Breakdown Voltage	200	—	200	—	V	$V_{GS} = 0V, I_D = 1.0mA$
$V_{GS(th)}$	Gate Threshold Voltage ④	2.0	4.0	1.25	4.5		$V_{GS} = V_{DS}, I_D = 1.0mA$
I_{GSS}	Gate-to-Source Leakage Forward	—	100	—	100	nA	$V_{GS} = +20V$
I_{GSS}	Gate-to-Source Leakage Reverse	—	-100	—	-100		$V_{GS} = -20V$
I_{DSS}	Zero Gate Voltage Drain Current	—	25	—	25	μA	$V_{DS} = 0.8 \times \text{Max Rating}, V_{GS} = 0V$
$R_{DS(on)1}$	Static Drain-to-Source On-State Resistance One ④	—	0.40	—	0.53	Ω	$V_{GS} = 12V, I_D = 6.0A$
V_{SD}	Diode Forward Voltage ④	—	1.4	—	1.4	V	$T_C = 25^\circ C, I_S = 9.4A, V_{GS} = 0V$

Table 2. High Dose Rate ⑧

Parameter	Description	10^{11} Rads (Si)/sec			10^{12} Rads (Si)/sec			Units	Test Conditions
		Min	Typ	Max	Min	Typ	Max		
V_{DSS}	Drain-to-Source Voltage	—	—	160	—	—	160	V	Applied drain-to-source voltage during gamma-dot
I_{PP}	Peak radiation induced photo-current	—	20	—	—	20	—	A	Peak radiation induced photo-current
di/dt	Rate of rise of photo-current	—	—	160	—	—	8.0	A/ μ sec	Rate of rise of photo-current
L_1	Circuit inductance required to limit di/dt	1.0	—	—	20	—	—	μH	Circuit inductance required to limit di/dt

Table 3. Single Event Effects ⑨

Parameter	Typical	Units	Ion	LET (Si) (MeV/mg/cm ²)	Fluence (ions/cm ²)	Range (μm)	V_{DS} Bias (V)	V_{GS} Bias (V)
BV_{DSS}	200	V	Ni	28	1×10^5	~41	160	-5

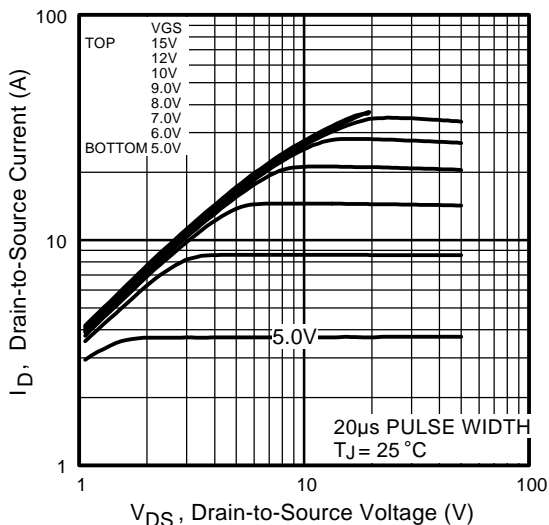

Fig 1. Typical Output Characteristics

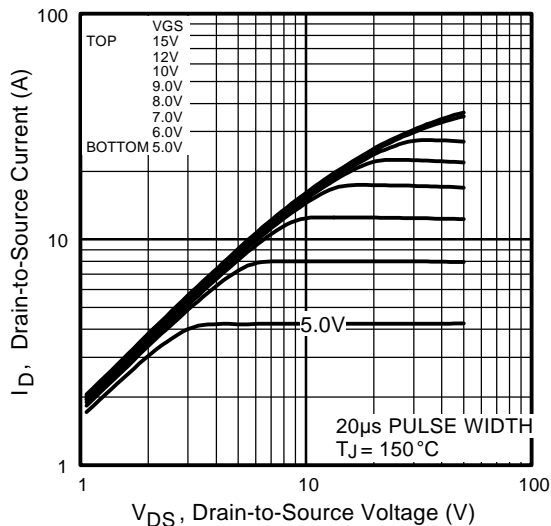

Fig 2. Typical Output Characteristics

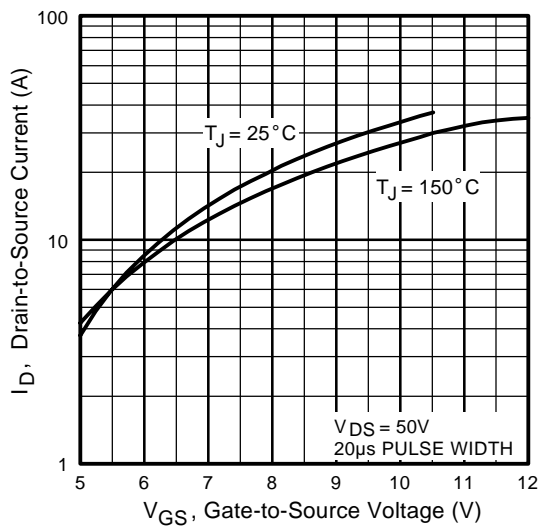

Fig 3. Typical Transfer Characteristics

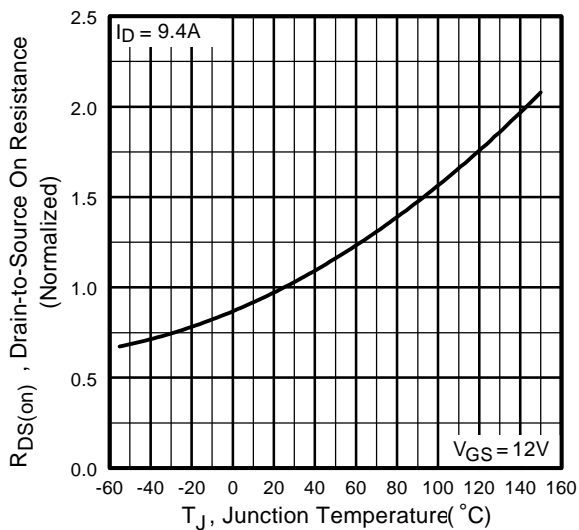

Fig 4. Normalized On-Resistance Vs. Temperature

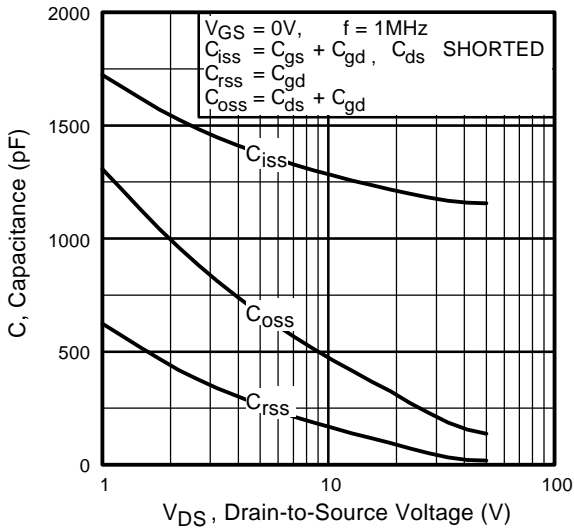

Fig 5. Typical Capacitance Vs. Drain-to-Source Voltage

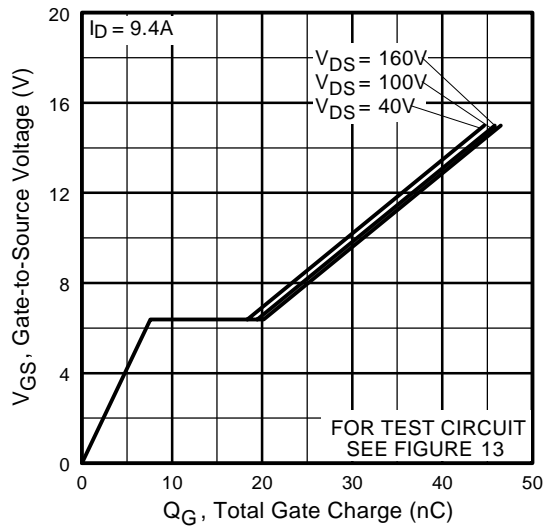

Fig 6. Typical Gate Charge Vs. Gate-to-Source Voltage

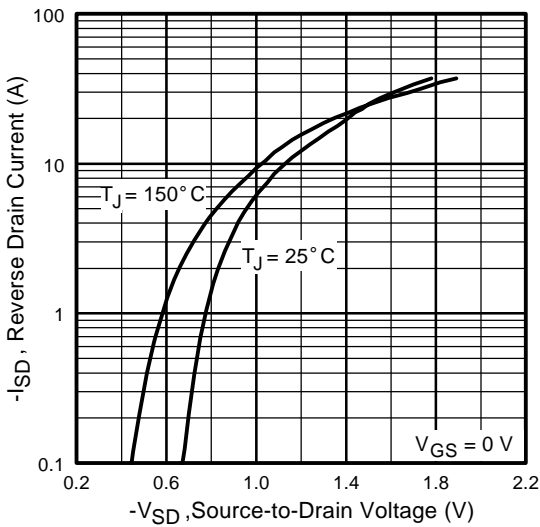

Fig 7. Typical Source-Drain Diode Forward Voltage

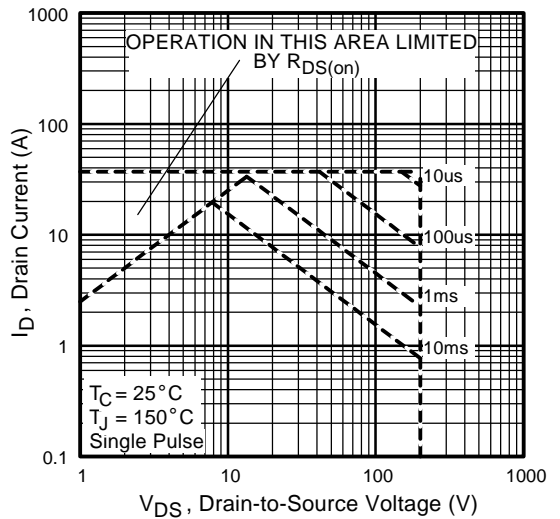

Fig 8. Maximum Safe Operating Area

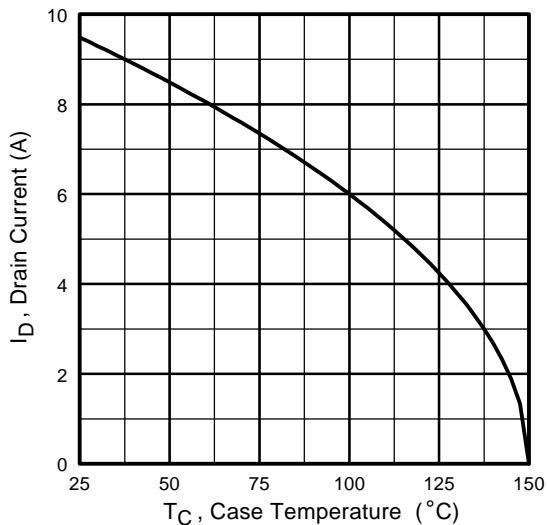

Fig 9. Maximum Drain Current Vs. Case Temperature

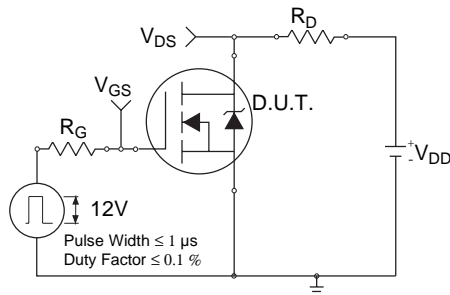

Fig 10a. Switching Time Test Circuit

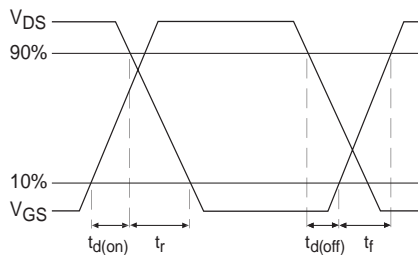

Fig 10b. Switching Time Waveforms

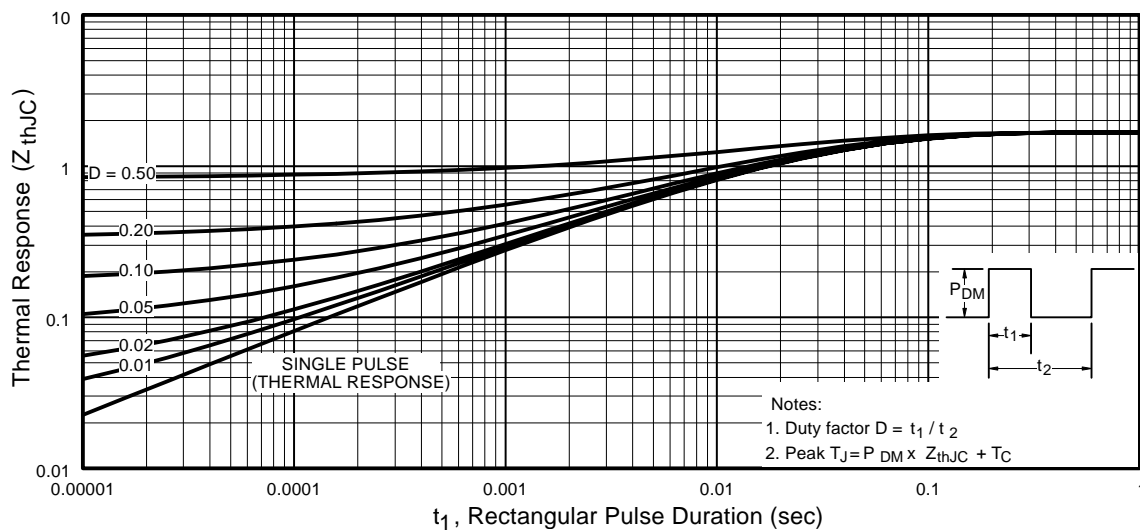

Fig 11. Maximum Effective Transient Thermal Impedance, Junction-to-Case

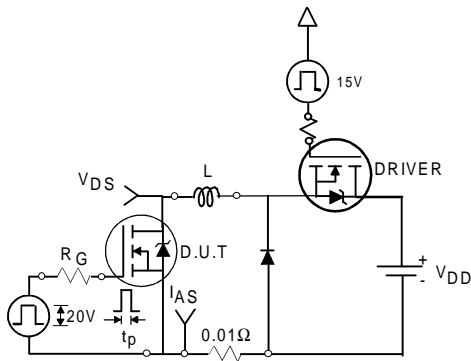

Fig 12a. Unclamped Inductive Test Circuit

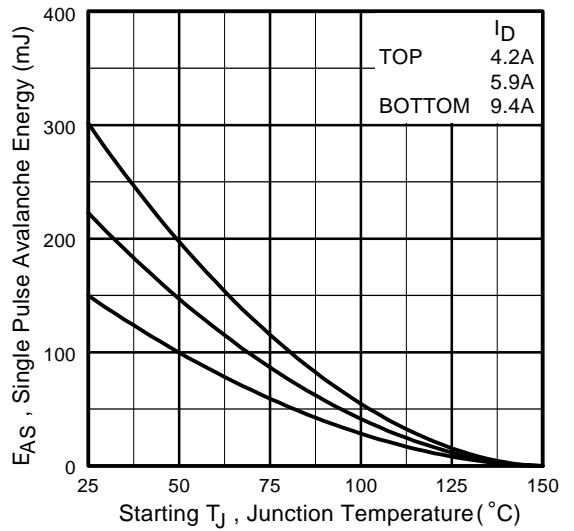

Fig 12c. Maximum Avalanche Energy Vs. Drain Current

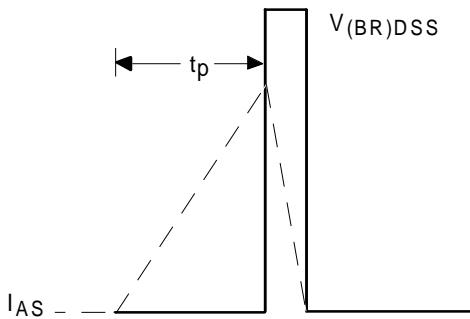

Fig 12b. Unclamped Inductive Waveforms

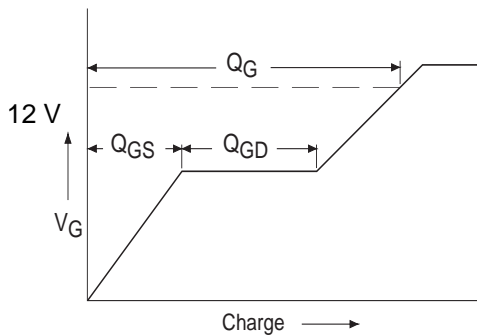

Fig 13a. Basic Gate Charge Waveform

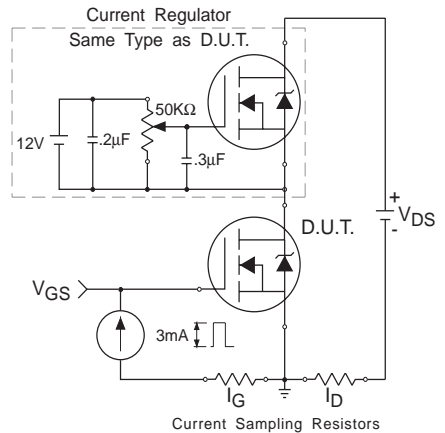
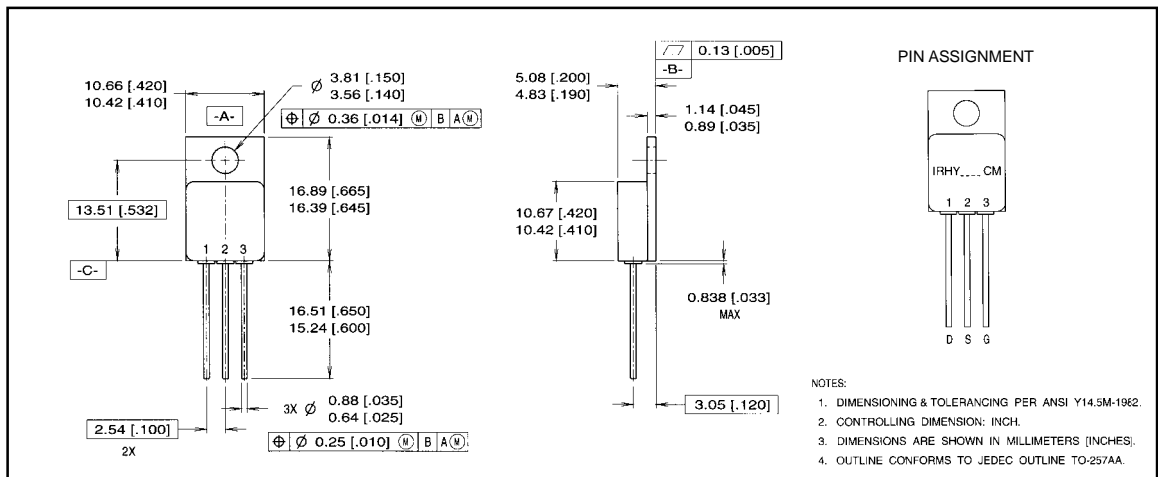

Fig 13b. Gate Charge Test Circuit

- ① Repetitive Rating; Pulse width limited by maximum junction temperature. Refer to current HEXFET reliability report.
- ② @ $V_{DD} = 50V$, Starting $T_J = 25^\circ C$,
 $E_{AS} = [0.5 * L * (I_L^2)]$
 Peak $I_L = 9.4A$, $V_{GS} = 12V$, $25 \leq R_G \leq 200\Omega$
- ③ $I_{SD} \leq 9.4A$, $di/dt \leq 660A/\mu s$,
 $V_{DD} \leq BV_{DSS}$, $T_J \leq 150^\circ C$
 Suggested $R_G = 2.35\Omega$
- ④ Pulse width $\leq 300 \mu s$; Duty Cycle $\leq 2\%$
- ⑤ $K/W = ^\circ C/W$
 $W/K = W/^\circ C$
- ⑥ **Total Dose Irradiation with V_{GS} Bias.**
 12 volt V_{GS} applied and $V_{DS} = 0$ during irradiation per MIL-STD-750, method 1019.
- ⑦ **Total Dose Irradiation with V_{DS} Bias.**
 $V_{DS} = 0.8$ rated BV_{DSS} (pre-radiation) applied and $V_{GS} = 0$ during irradiation per MIL-STD-750, method 1019.
- ⑧ This test is performed using a flash x-ray source operated in the e-beam mode (energy ~ 2.5 MeV), 30 nsec pulse.
- ⑨ Process characterized by independent laboratory.
- ⑩ All Pre-Radiation and Post-Radiation test conditions are **identical** to facilitate direct comparison for circuit applications.

Case Outline and Dimensions — TO 257AA



CAUTION

BERYLLIA WARNING PER MIL-PRF-19500

Package containing beryllia shall not be ground, sandblasted, machined, or have other operations performed on them which will produce beryllia or beryllium dust. Furthermore, beryllium oxide packages shall not be placed in acids that will produce fumes containing beryllium.

International
IOR Rectifier

WORLD HEADQUARTERS: 233 Kansas St., El Segundo, California 90245, Tel: (310) 322 3331

EUROPEAN HEADQUARTERS: Hurst Green, Oxted, Surrey RH8 9BB, UK Tel: ++ 44 1883 732020

IR CANADA: 7321 Victoria Park Ave., Suite 201, Markham, Ontario L3R 2Z8, Tel: (905) 475 1897

IR GERMANY: Saalburgstrasse 157, 61350 Bad Homburg Tel: ++ 49 6172 96590

IR ITALY: Via Liguria 49, 10071 Borgaro, Torino Tel: ++ 39 11 451 0111

IR FAR EAST: K&H Bldg., 2F, 30-4 Nishi-Ikebukuro 3-Chome, Toshima-Ku, Tokyo Japan 171 Tel: 81 3 3983 0086

IR SOUTHEAST ASIA: 315 Outram Road, #10-02 Tan Boon Liat Building, Singapore 0316 Tel: 65 221 8371