

Displaytech Ltd.

Website: www.displaytech-us.com

LCD Module
Product Specification

Product: S128240C Series LCD Module (240 x 128 DOTS)

PRODUCT SPECIFICATIONS

- GENERAL SPECIFICATION
- ABSOLUTE MAXIMUM RATINGS
- ELECTRICAL CHARACTERISTICS
- ELECTRO-OPTICAL CHARACTERISTICS
- BLOCK DIAGRAM
- MECHANICAL DRAWING
- BACKLIGHT DRAWING
- BACKLIGHT SPECIFICATION
- QUALITY GUARANTEE
- PRECAUTIONS FOR USING LCD MODULES
- USING LCD MODULES
- REVISION RECORD

Contents in this document are subject to change without notice. No part of this document may be reproduced or transmitted in any form or by any means, electronic or mechanical, for any purpose, without the express written permission of Displaytech Ltd.

■ GENERAL SPECIFICATION

Item	Contents
Display Format	240 x 128 DOTS
Dot Size (W x H)	0.22 x 0.22
View Area (W x H)	70.0 mm x 35.0mm
Module Size (W x H x T)	77.4 mm x 52.4mm x 9.3 mm
LCD Type	FSTN
Polarizer Mode	Transflective
View Angle	6 / 12 O'clock
Backlight	LED
Backlight Driver Type	External Power
Backlight Color	White
Controller & LCD Driver	ST7529-G
Driving Method	1/144 Duty, 1/12 Bias

■ ABSOLUTE MAXIMUM RATINGS (Ta=25°C VSS=0V)

ITEM	SYMBOL	MIN.	TYP.	MAX.	UNIT
Power Supply for Logic	VDD-VSS	-0.5	---	4.0	V
Power Supply for LCD	VLCD-VSS	-0.5	---	20.0	V
Input Voltage	VIN	-0.5	---	VDD+0.5	V
Supply Voltage for LED Backlight	V _{LED}	---	3.2	---	V
Normal Operating Temperature	Top	0	---	50	°C
Normal Storage Temperature	Tst	-10	---	60	°C
Wide Operating Temperature	Top	-20	---	70	°C
Wide Storage Temperature	Tst	-30	---	80	°C

■ ELECTRICAL CHARACTERISTICS (Ta=25°C, VDD=3.0V+/-5%)

ITEM	SYMBOL	CONDITION	MIN.	TYP.	MAX.	UNIT
Power Supply for LCM	VDD-VSS	---	2.85	3.0	3.15	Volt
Input Voltage	VIL	L level	V _{ss}	---	0.3VDD	Volt
	VIH	H level	0.7VDD	---	VDD	Volt
LCD Module Driving Voltage	VO-VSS	---	---	---	---	Volt
		25°C	---	14.5	---	
		---	---	---	---	
Supply Current for LCM	IDD	VDD=3.0V	---	2.0	---	mA
	Ie	---	---	---	---	
	ILED	VLED=3.2V	---	80	---	

■ ELECTRO-OPTICAL CHARACTERISTICS

NO	Item	Symbol	Measuring Condition	STD.Value				Unit	Remark
				°C	Min	Typ	Max		
1	Recommended Operating Voltage	VLCD	$\theta = 0$ $\Phi = 0$	25	14	14.5	15	V	Note1 Note2
2	Operating Voltage	Vth	$\theta = 0$ $\Phi = 0$	0	---	---	---		
				25	---	1.869	---		
				40	---	---	---		
		Vsat	$\theta = 0$ $\Phi = 0$	0	---	---	---		
				25	---	2.116	---		
				40	---	---	---		
3	Response time	Tr	$\theta = 0$ $\Phi = 10$	0	---	---	---		
				25	---	240	---		
				40	---	---	---		
		Tf	$\theta = 0$ $\Phi = 10$	0	---	---	---		
				25	---	200	---		
				40	---	---	---		
4	Viewing Angle ($Cr \geq 2$)	θ	$\Phi = 0^\circ$	25	---	40	---		
		θ	$\Phi = 180^\circ$	25	---	35	---		
		θ	$\Phi = 90^\circ$	25	---	30	---		
		θ	$\Phi = 270^\circ$	25	---	30	---		
5	Current Consumption	ILCD	Hz=64	25	---	18	---	uA	Note3

NOTE 1: DEFINITION OF VIEWING ANGLE AND DIRECTION

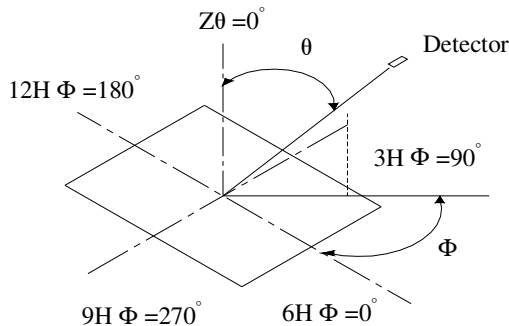

NOTE 2: THERSHOLD VOLTAGE AND SATURATION VOLTAGE

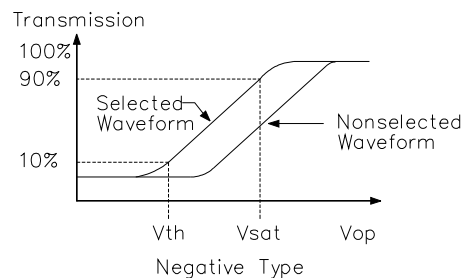
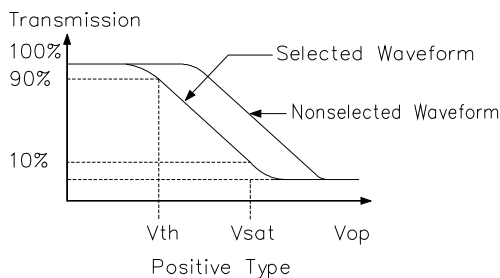

Vth: The voltage Vop which the transmission rate of segment is 90%(positive) or 10%(negative) of saturated value on conditions of the selected waveform. (non-selected waveform is opposition)

Vsat: The voltage Vop which the transmission rate of segment is 10%(positive) or 10%(negative) of saturated value on conditions of the selected waveform. (non-selected waveform is opposition)

NOTE 3: CURRENT CONSUMPTION (I_{LCD})

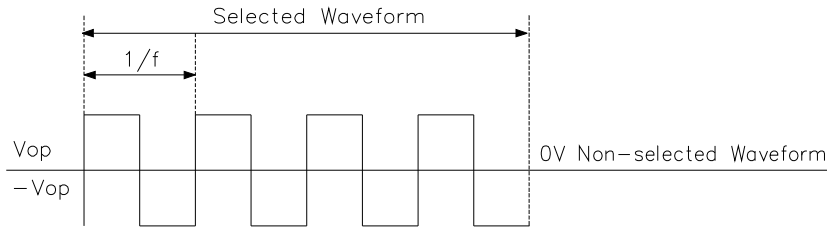

Conditions:

1. Driving waveform: static waveform.

2. Voltage applied to all segments

NOTE 4: RESPONSE TIME (T_r , T_f)

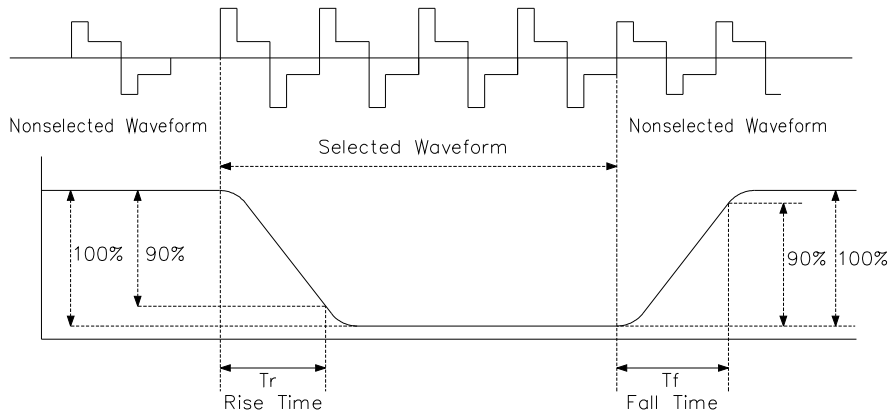

NOTE 5: CONTRAST RATIO (CR)

5.1 POSITIVE TYPE:

$$\text{CONTRAST RATIO} = \frac{\text{BRIGHTNESS AT VOP (NON-SELECTED)}}{\text{BRIGHTNESS AT VOP (SELECTED)}}$$

5.2 NEGATIVE TYPE:

$$\text{CONTRAST RATIO} = \frac{\text{BRIGHTNESS AT VOP (SELECTED)}}{\text{BRIGHTNESS AT VOP (NON-SELECTED)}}$$

NOTE 6: CAPACITANCE (C)

Measuring Methode Of Capacitance



Conditions:

Voltage applied to all segments.

■ BLOCK DIAGRAM

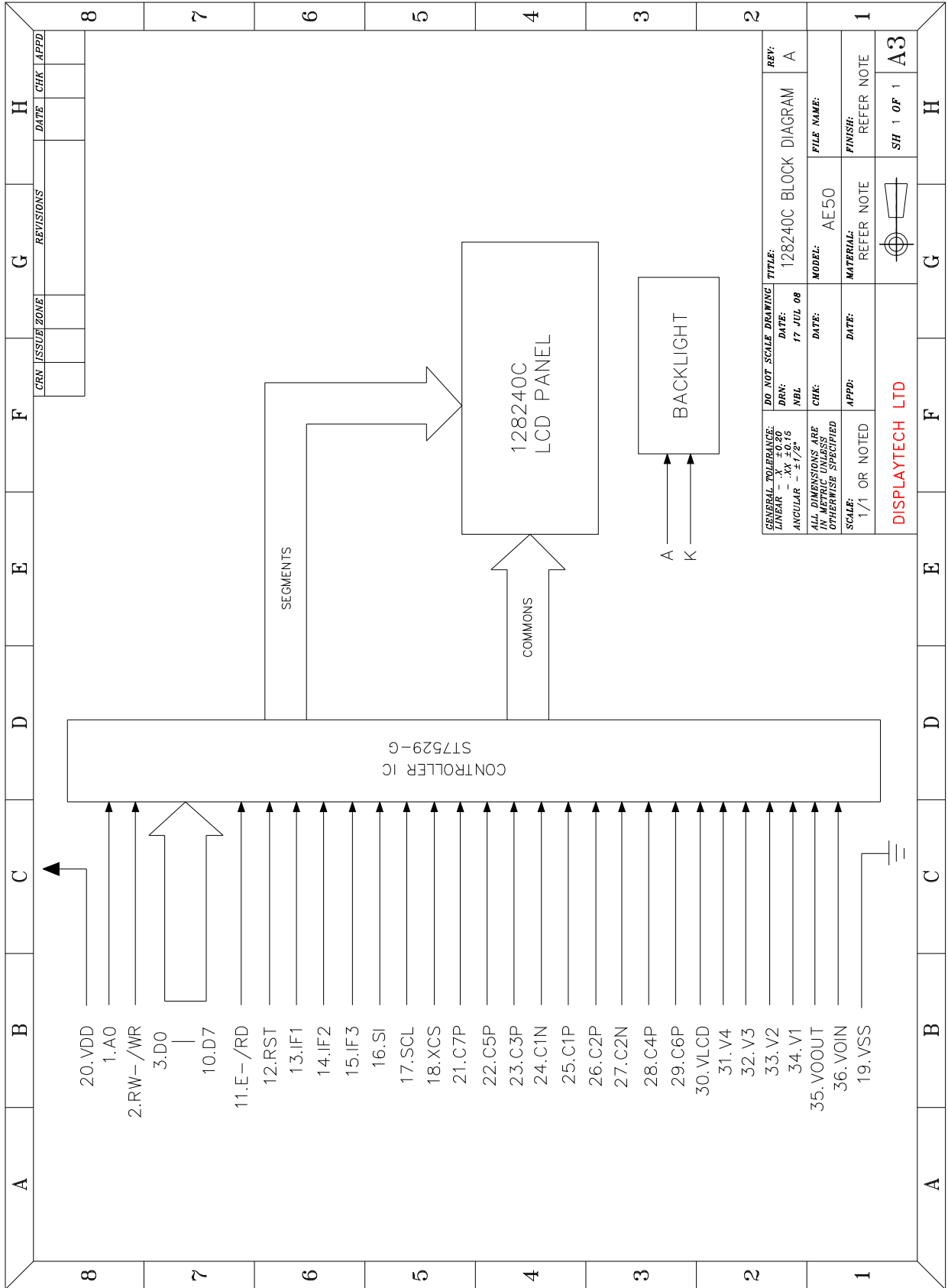

MECHANICAL DRAWING

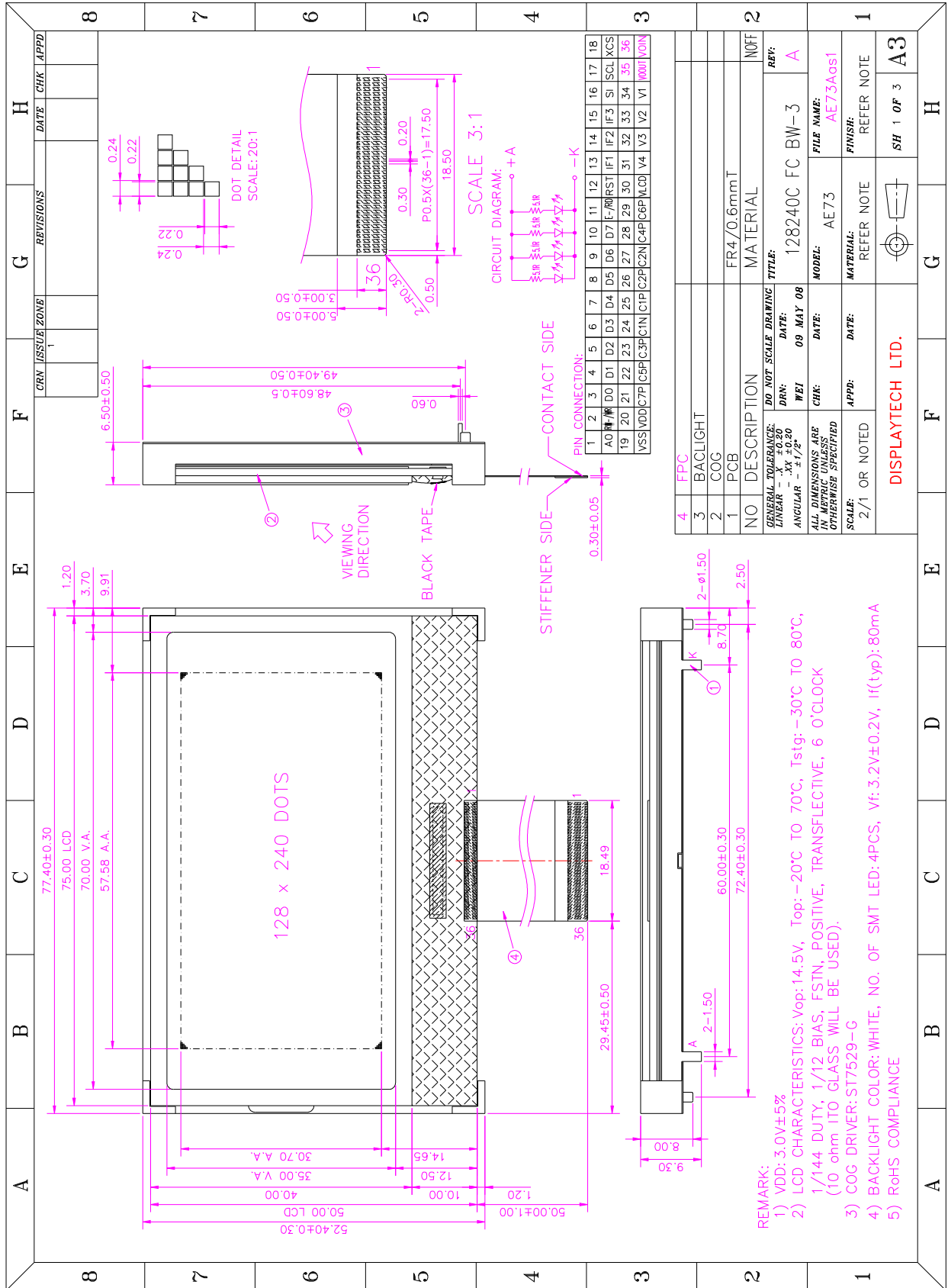

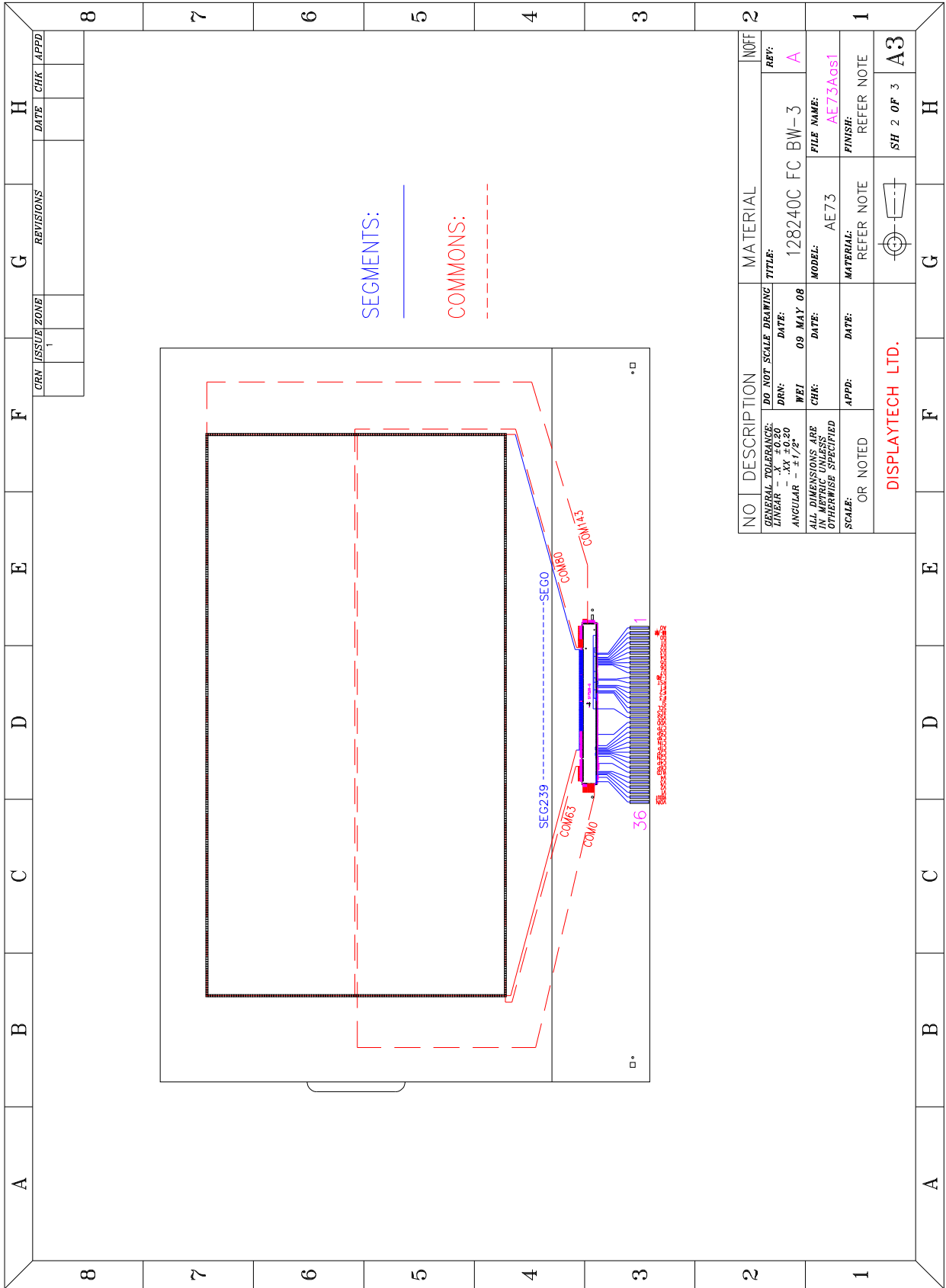

NO	DESCRIPTION	MATERIAL	NOFF
2	GENERAL TOLERANCES: LINEAR - .XX ±0.20 ANGULAR - ±1/2° ALL DIMENSIONS ARE IN METRIC UNLESS OTHERWISE SPECIFIED SCALE: OR NOTED	TITLE: 128240C FC BW-3 DATE: 09 MAY 08 MODEL: AE73 MATERIAL: AE73 FINISH: AE73Ag81	REV: A FILE NAME: AE73Ag81 REFER NOTE REFER NOTE
1	OR NOTED DISPLAYTECH LTD.	REFER NOTE REFER NOTE SH 2 OF 3	A3

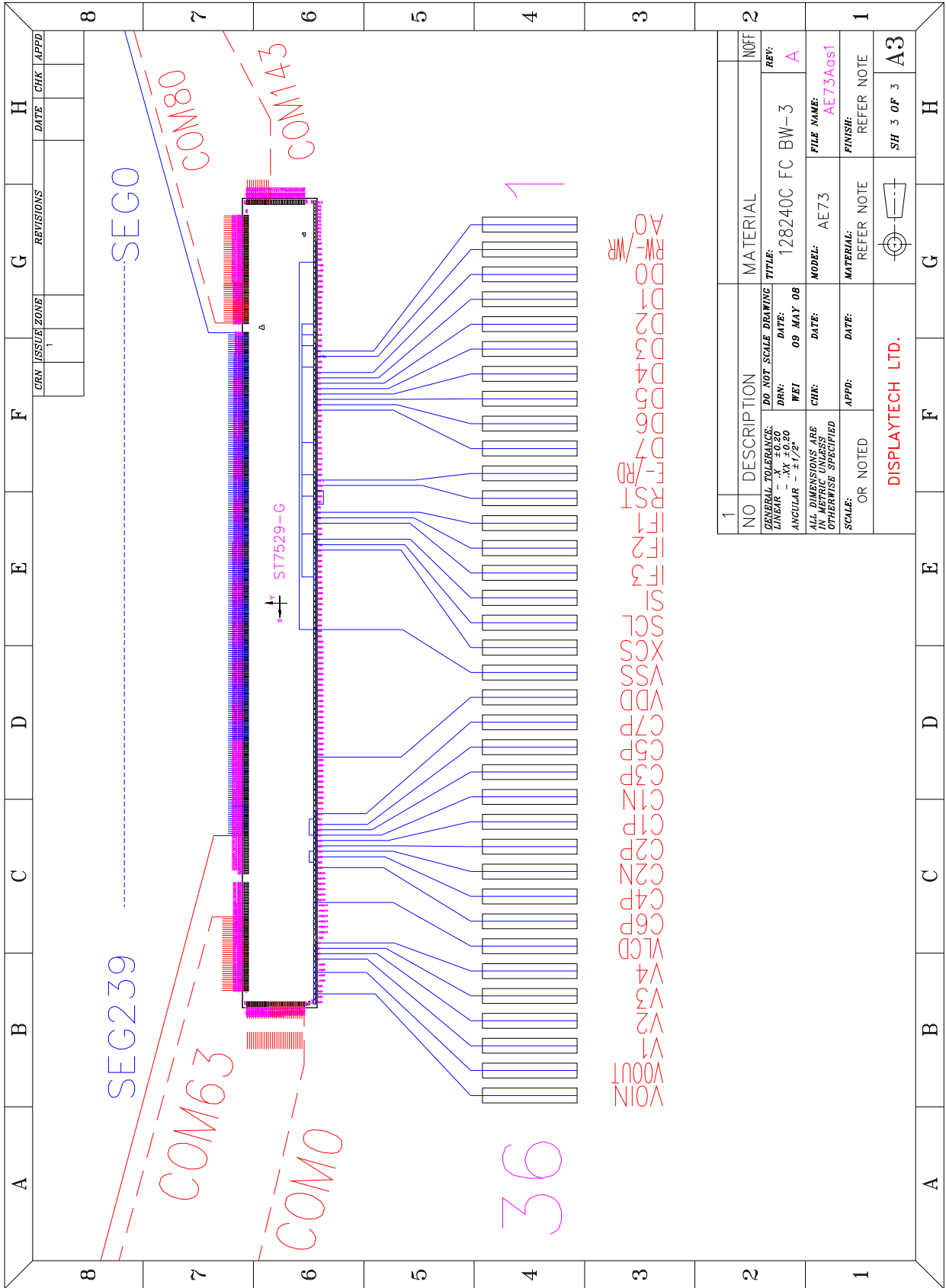

1	NO DESCRIPTION	MATERIAL	NOFF
GENERAL TOLERANCES: LINEAR - .X ±0.20 ANGULAR - ±1/2°		TITLE: 128240C FC BW-3	REV: A
DO NOT SCALE DRAWING DRN: DATE: 09 MAY 08		MODEL: AE73	FILE NAME: AE73Aos1
ALL DIMENSIONS ARE IN METRIC UNLESS OTHERWISE SPECIFIED		MATERIAL: REFER NOTE	FINISH: REFER NOTE
SCALE: OR NOTED		SH 3 OF 3	
DISPLAYTECH LTD.			

BACKLIGHT DRAWING

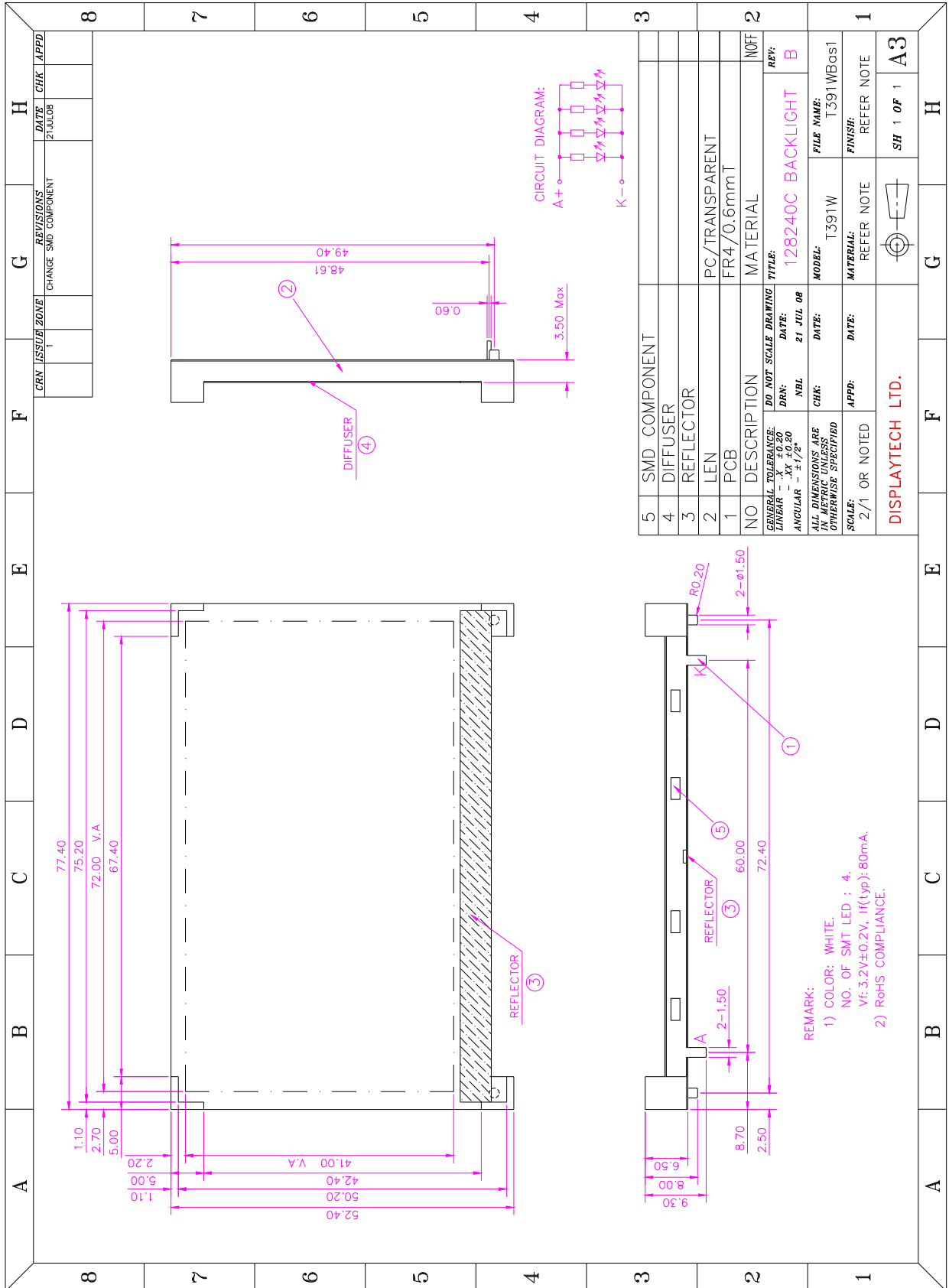

5	SMD COMPONENT		
4	DIFFUSER		
3	REFLECTOR		
2	LEN	PC/TRANSPARENT	
1	PCB	FR4/0.6mmT	
NO	DESCRIPTION	MATERIAL	NOFF
GENERAL TOLERANCE:		DO NOT SCALE DRAWING	
LINEAR	- .XX ±0.20	DRN:	DATE: 21 JUL 08
ANGULAR	- ±1/2°	NBL	CHK:
ALL DIMENSIONS ARE IN METRIC UNLESS OTHERWISE SPECIFIED		FILE NAME: T391WB.os1	
SCALE:	2/1 OR NOTED	MATERIAL:	REFER NOTE
DISPLAYTECH LTD.		FINISH:	REFER NOTE
		MODEL:	T391W
		APPD:	
		DATE:	
		REF:	B
		TITLE:	128240C BACKLIGHT
		SH 1 OF 1	A3

REMARK:
 1) COLOR: WHITE.
 NO. OF SMT LED : 4.
 Vf: 3.2V±0.2V, If(typ): 80mA.
 2) RoHS COMPLIANCE.

■ **BACKLIGHT SPECIFICATION**

◆ **MECHANICAL SPECIFICATIONS**

ITEM	NOMINAL DIMENSIONS	UNIT
OUTLINE SIZE (LxWxH)	77.40 x 52.40x 9.30	mm
VIEWING AREA (LxW)	72.00 x 41.00	mm
CONTACT PIN PITCH/LENGTH	NIL	mm
NO.OF LED SMT	4	---

◆ **ELECTRICAL/OPTICAL CHARACTERISTICS (Ta=25°C, If=80mA typ.)**

MODE	PARAMETER	UNIT
COLOR	WHITE	---
CHROMATICITY COORDINATE	X=0.25~0.35 Y=0.25~0.35	---
AVERAGE LUMINOUS INTENSITY (IV)	225 typ.	cd/m ²
FORWARD VOLTAGE (Vf)	3.2 typ.	V

◆ **ABSOLUTE MAXIMUM RATING**

ITEM	VALUE	UNIT
FORWARD CURRENT	120mA	If
REVERSE VOLTAGE	5V	Vr
POWER DISSIPATION	384mW	Pd
OPERATING TEMPERATURE	-20°C TO 70°C	Top
STORAGE TEMPERATURE	-30°C TO 80°C	Tstg

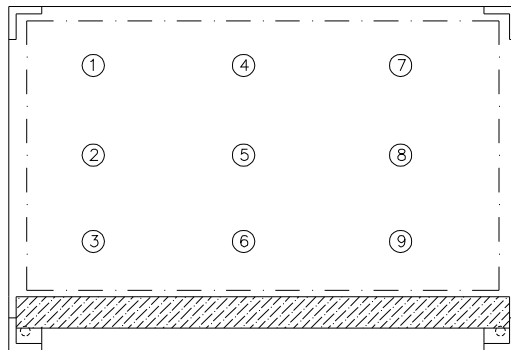

TESTING POINTS

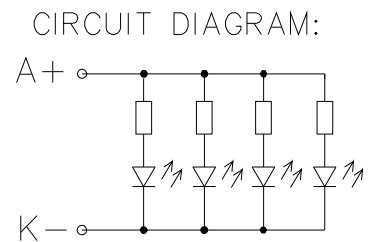

CIRCUIT DIAGRAM

REMARK:

1. AVERAGE LUMINOUS INTENSITY IS THE AVERAGE VALUE OF THE NINE INDICATED POINTS AS SHOWN.
2. MEASUREMENT INSTRUMENT: BM-7, APERTURE: Ø10mm.

■ **QUALITY GUARANTEE**

◆ **PURPOSE:** It is to define the inspection standard of LCD modules

◆ **PRODUCT STANDARD**

1) INSPECTION AND TEST

- FUNCTION TEST
- APPEARANCE INSPECTION
- PACKING SPECIFICATION

2) INSPECTION CONDITION

- Put under the lamp (20w×2) at a distance 100mm from the LCD Modules.
- Tilt upright 45 degree by the front (back) to inspect LCD appearance.

3) AQL INSPECTION LEVEL

- SAMPLING METHOD : MIL-STD-105D
- SAMPLING PLAN : SINGLE
- MAJOR DEFECT : 0.65% (MAJOR)
- MINOR DEFECT : 2.5% (MINOR)
- GENERAL LEVEL : II/NORMAL

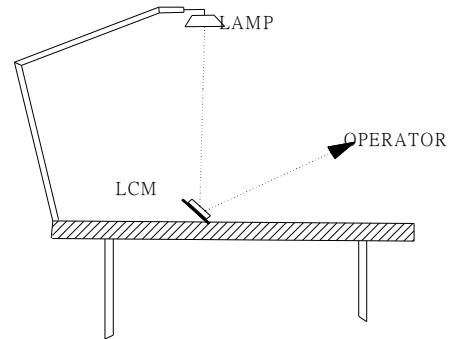

◆ **DISPLAY AREA DEFINITION:**

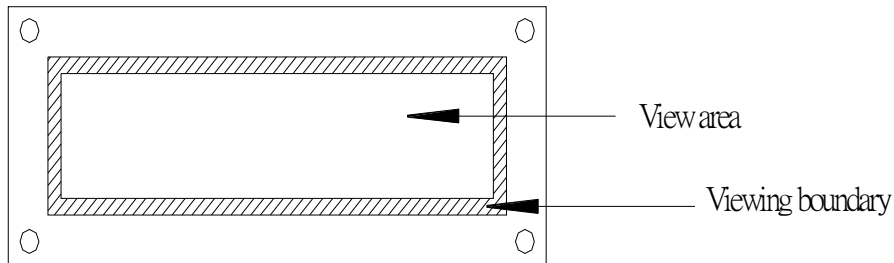

◆ INSPECTION STANDARD

1) FUNCTIONAL TEST STANDARD

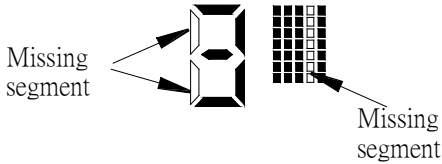
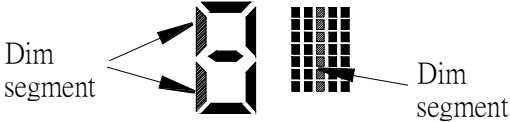
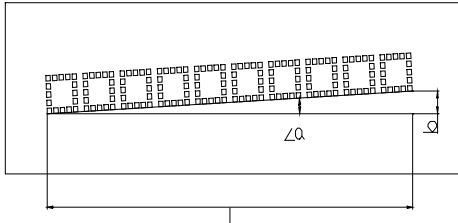
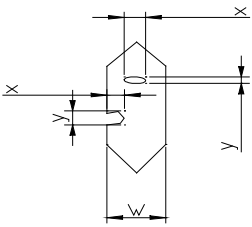

Item	Inspection Standard Description		Standard	Defect type		
1	LCD has no display		Reject	MAJ		
2	LCM display do not change		Reject	MAJ		
3	Display wrong pattern		Reject	MAJ		
4	Display segment open		Reject	MAJ		
5	Display dim segment		Reject	MAJ		
6	Wrong LCD viewing direction		Reject	MAJ		
7	Dim Display		See sample	MAJ		
8	LCD color variation		See sample	MAJ		
9	Pattern parallelism 	Acceptable range		Accept		
		L	<a		b	
		≥ 20mm	0.43°		≤ 0.15mm	
		≥ 30mm	0.38°		≤ 0.2mm	
		≥ 40mm	0.43°		≤ 0.3mm	
		≥ 50mm	0.40°		≤ 0.35mm	
		≥ 60mm	0.43°		≤ 0.45mm	
		≥ 70mm	0.41°		≤ 0.50mm	
		≥ 80mm	0.43°		≤ 0.60mm	
≥ 90mm	0.41°	≤ 0.65mm				
≥ 100mm	0.43°	≤ 0.75mm				
10	LCD display Pin hole		Standard			
			$\varnothing = \frac{x+y}{2}$	QTY		
			$\varnothing \leq 0.25$	1		Accept
			$\varnothing > 0.25$	1		Accept
			$\varnothing < \frac{1}{4} W$	1		Accept
		$\varnothing > \frac{1}{4} W$	1	Reject	MIN	

Item	Inspection Standard Description			Standard	Defect type		
11	LCD display Broken segment(dots)		Draw		Standard		
			X	y	QTY		
			$\geq \frac{1}{4}b$	$\geq \frac{1}{4}a$	1	Reject	MIN
			$(X \text{ or } y) \geq 0.2\text{mm}$		1	Reject	MIN
			$\leq \frac{1}{4}b$	$\leq \frac{1}{4}a$	1	Accept	
		$\leq \frac{1}{5}b$	$\leq \frac{1}{5}a$	2	Accept		
12	LCD display Black spot or White spot		$\varnothing = \frac{x+y}{2}$		QTY		
			$\varnothing < 0.10$			Accept	
			$0.1 < \varnothing \leq 0.20$		2	Accept	
			$0.20 \leq \varnothing < 0.25$		1	Accept	
			$0.25 < \varnothing \leq 0.4$		0	Reject	MIN
			$\varnothing > 0.4$		0	Reject	MAJ
13	LCD display excess black line or white line	Black line/white line(Lxw)mm		QTY			
		$(L \leq 1.0) \times (W \leq 0.025)$		2	Accept		
		$(1.0 < L \leq 1.5) \times (W \leq 0.025)$		1	Accept		
		$(L > 1.5) \times (W \leq 0.025)$		0	Reject	MIN	
		$(L > 2) \times (W > 0.025)$		0	Reject	MAJ	
14	Backlight not function				Reject	MAJ	
15	LED not function or dim				Reject	MIN	
16	Backlight defect (dirt, scratch)				Reject	MIN	

2) COSMETIC INSPECTION STANDARD

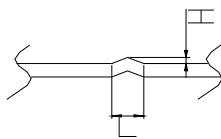
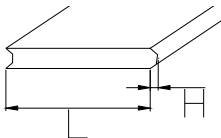
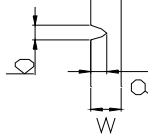
Item	Standard description of inspection			Standard	Defect type		
1	LCD inspection item						
1.1	LCD color variation			See sample	MIN		
1.2	LCD broken			Reject	MAJ		
1.3	Wrong polarizer of LCD			Reject	MAJ		
1.4	Spot on LCD surface			Reject	MAJ		
1.5	Scratch on LCD		Scratch = \varnothing		QTY		
			$\varnothing < 0.1$		Except	Accept	
			$0.1 \leq \varnothing \leq 0.15$		2	Accept	
			$0.15 < \varnothing \leq 0.25$		1	Accept	
			$\varnothing > 0.25$		1	Reject	MIN
1.6	LCD scratch		Scratch = L	scratch = W	QTY		
				$W \leq 0.015$		Accept	
			< 0.5	$W \leq 0.02$	2	Accept	
			< 1.0	$W \leq 0.03$	1	Accept	
			≥ 1.0	$W \geq 0.03$	1	Reject	MIN
1.7	White or black spot on LCD		$\varnothing = \frac{x+y}{2}$		QTY		
			$\varnothing < 0.1$			Accept	
			$0.1 \leq \varnothing < 0.2$		2	Accept	
			$0.2 \leq \varnothing \leq 0.25$		1	Accept	
			$\varnothing > 0.25$		1	Reject	MIN
			Bevy point		-	Reject	MIN

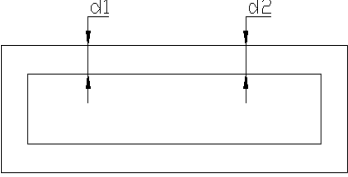
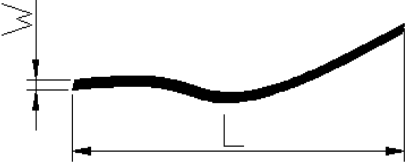
Item	Standard description of inspection			Standard	Defect type	
1.8		(L)	(W)	QTY		
		$L \leq 1.0$	$W \leq 0.025$	2	Accept	
		$1.0 < L \leq 1.5$	$W \leq 0.025$	1	Accept	
		$1.5 < L$	$W > 0.025$	1	Reject	MIN
1.9	Round air bubble	Size	QTY			
		$\varnothing < 0.15$	2	Accept		
		$0.15 \leq \varnothing \leq 0.25$	1	Accept		
		$\varnothing > 0.25$	0	Reject	MIN	
1.10	Line defect	(L)	(W)	QTY		
		$L < 0.5$	$W < 0.02$	2	Accept	
		$L < 1.0$	$W < 0.03$	1	Accept	
		$L \geq 1.0$	$W \geq 0.3$	0	Reject	MIN
1.11	Finger print			Reject	MIN	
2	PCB/COB specification					
2.1	PCB deformity		L	H		
			$\leq 6.0\text{mm}$	$\leq 1.5\text{mm}$	Accept	
			$> 6.0\text{mm}$	$\leq 1.5\text{mm}$	Reject	MIN
			$< 6.0\text{mm}$	$> 1.5\text{mm}$	Reject	MIN
			$> 6.0\text{mm}$	$> 1.5\text{mm}$	Reject	MIN
2.2	Deformity at PCB edge, damage circuit.			Reject	MAJ	
2.3	Convex at PCB edge		L	H		
			$\leq 6.0\text{mm}$	$\leq 1.5\text{mm}$	Accept	
			$> 6.0\text{mm}$	$\leq 1.5\text{mm}$	Reject	MIN
			$< 6.0\text{mm}$	$> 1.5\text{mm}$	Reject	MIN
			$> 6.0\text{mm}$	$> 1.5\text{mm}$	Reject	MIN
2.4	Damage excess 2x2mm at the PCB corner			Reject	MIN	
2.5	Scratch on PCB surface			See sample	MIN	
2.6	Scratch on PCB coat/leakage coat on PCB surface			Reject	MAJ	
2.7	Open circuit			Reject	MAJ	
2.8	PCB PTH open			Reject	MAJ	
2.9	Repair PCB PTH		QTY $\leq 2\text{PCS}$	Accept		
			QTY $\geq 3\text{PCS}$	Reject	MAJ	
2.10	Color different from one side to another side.			Reject	MIN	
2.11	Repaired solder mask area		$\leq 30\text{mm}^2$	Accept		
			$\geq 30\text{mm}^2$	Reject	MIN	
2.12	Scratch circuit, damage Circuit		$a \leq 1/2w$ or $b < w$	Accept		
			$a > 1/2w$ or $b > w$	Reject		
3	Bezel specification					
3.1	Wrong Materials				MAJ	
3.2	Incorrect dimension				MAJ	
3.3	Bezel broken				MAJ	
3.4	Rust on Bezel				MAJ	
3.5	Hole or dirty on oil Paint surface	Top surface	Size	cm^2/per		
			$\varnothing \leq 0.3$	2	Accept	
			$0.3 < \varnothing \leq 0.5$	1	Accept	
		$\varnothing > 0.5$	0	Reject	MIN	
		Side	$\varnothing \leq 0.5$	2	Accept	
			$0.5 < \varnothing \leq 0.8$	1	Accept	
$\varnothing > 0.8$	0		Reject	MIN		

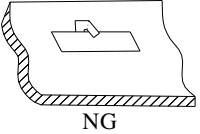
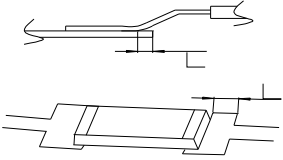
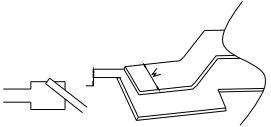
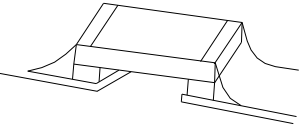
Item	Standard description of inspection		Standard	Defect type	
3.6	Bezel bow or twist		$h \leq 0.01$ mm/mm	Accept	
			$h > 0.01$ mm/mm	Reject	
3.7			$d1 - d2 \leq \text{tolerance}$	Accept	
			$d1 - d2 > \text{tolerance}$	Reject	
3.8	Scratch on bezel 	Face		Accept QTY	
		L	W	Not defined	See Sample
		-	$W \leq 0.15$		
		$L \leq 3$	$W \leq 0.20$	2	
		$L \leq 2$	$W \leq 0.3$	2	
		-	$W > 0.3$		
		side		Accept QTY	
		L	W	except	See Sample
-	$W \leq 0.2$				
$L \leq 3$	$W \leq 0.25$	2			
$L \leq 2$	$W \leq 0.3$	2			
3.9	Twist angle $\alpha = 45^\circ \pm 5^\circ$			Accept	
3.10	Void gap between bezel and PCB		Reject	MIN	
3.11	Bezel clip incorrectly 		Reject	MIN	
4	Solder specification				
4.1	Wrong component		Reject	MAJ	
4.2	Broken component		Reject	MAJ	
4.3	Mis-alignment 	Component legs extend beyond the pad and Legs > pad distance(w) on solder area > W ²		Accept	
		Component legs extend beyond the pad and Legs > pad distance(w) on solder area < W ²		Reject	
	Component Offset 	Solder legs offset distance L < solder legs 1/4W		Accept	
		Solder legs offset L > 1/4W		Reject	
4.4	Component assembly defect 		Reject	MIN	
4.5	CHIP components hoist ≤ 0.5 mm		Accept		
4.6	CHIP components hoist > 0.5mm		Reject	MIN	

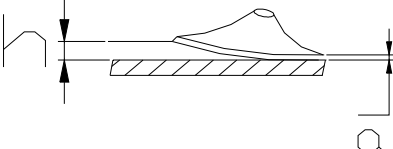
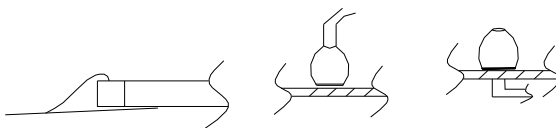
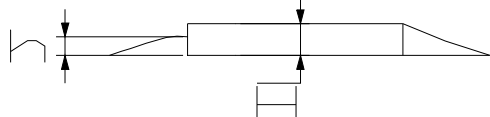
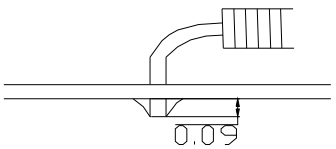
Item	Standard description of inspection	Standard	Defect type
4.7	Components hoist	$h \leq 2.0\text{mm}$	Accept
		$h > 2.0\text{mm}$	Reject
4.8	Switch (socket) hoist	$h \leq 0.5\text{mm}$	Accept
		$h > 0.5\text{mm}$	Reject
4.9	Components cold solder or incomplete solder	Reject	MAJ
4.10	Solder PAD tilt up, but height (h) less than Solder PAD thickness (a) 	Accept	
4.11	Excess solder above components 	Reject	Min
4.12	Insufficient solder below components height or less than diameter 	Reject	MIN
4.13	Solder area less than soldering PAD Area by 2/3	Reject	MIN
4.14	Trimmed pin length beyond 0.09inch (2.3mm) 	Reject	Min
5	Packing specification		
5.1	Wrong carton mark.	Reject	MAJ
5.2	Carton mark problem	Reject	MIN
5.3	Carton damage extend than 150mm	Reject	MAJ
5.4	Carton damage, scratch more 50mm, less 150mm.	Reject	MIN

■ PRECAUTIONS FOR USING LCD MODULES

◆ HANDLING PRECAUTIONS

1. This device is susceptible to Electro-Static Discharge (ESD) damage. Observe Anti-Static precautions.
2. The display panel is made of glass. Do not subject it to a mechanical shock by dropping it or impact.
3. If the display panel is damaged and the liquid crystal substance leaks out, be sure not to get any in your mouth. If the substance contacts your skin or clothes, wash it off using soap and water.
4. Do not apply excessive force to the display surface or the adjoining areas since this may cause the color tone to vary.
5. The polarizer covering the display surface of the LCD module is soft and easily scratched. Handle this polarizer carefully.
6. If the display surface becomes contaminated, breathe on the surface and gently wipe it with a soft dry cloth. If it is heavily contaminated, moisten cloth with one of the following solvents:
 - Isopropyl alcohol
 - Ethyl alcohol
7. Solvents other than those above-mentioned may damage the polarizer. Especially, do not use the following.
 - Water
 - Ketone
 - Aromatic solvents
8. Exercise care to minimize corrosion of the electrode. Corrosion of the electrodes is accelerated by water droplets, moisture condensation or a current flow in a high-humidity environment.
9. Install the LCD Module by using the mounting holes. When mounting the LCD module make sure it is free of twisting, warping and distortion. In particular, do not forcibly pull or bend the I/O cable or the backlight cable.
10. Do not attempt to disassemble or process the LCD module.
11. NC terminal should be open. Do not connect anything.
12. If the logic circuit power is off, do not apply the input signals.
13. To prevent destruction of the elements by static electricity, be careful to maintain an optimum work environment.
 - Be sure to ground the body when handling the LCD modules.
 - Tools required for assembling, such as soldering irons, must be properly grounded.
 - To reduce the amount of static electricity generated, do not conduct assembling and other work under dry conditions.
 - The LCD module is coated with a film to protect the display surface. Exercise care when peeling off this protective film since static electricity may be generated.

◆ POWER SUPPLY PRECAUTIONS:

1. Identify and, at all times, observe absolute maximum ratings for both logic and LC drivers. Note that there is some variance between models.
2. Prevent the application of reverse polarity to VDD and VSS, however briefly.
3. Use a clean power source free from transients. Power-up conditions are occasionally “jolting” and may exceed the maximum ratings of the modules.
4. The VDD power of the module should also supply the power to all devices that may access the display. Don't allow the data bus to be driven when the logic supply to the module is turned off.

◆ OPERATING PRECAUTIONS:

1. DO NOT plug or unplug the module when the system is powered up.
2. Minimize the cable length between the module and the host MPU.
3. For models with EL backlights, do not disable the backlight by interrupting the HV line. Unload inverters produce voltage extremes that may arc within a cable or at the display.
4. Operate the module within the limits of the modules temperature specifications.

◆ MECHANICAL/ENVIRONMENTAL PRECAUTIONS:

1. Improper soldering is the major cause of module difficulty. Use of flux cleaner is not recommended as they may seep under the elastomeric connection and cause display failure.
2. Mount the module so that it is free from torque and mechanical stress.
3. Surface of the LCD panel should not be touched or scratched. The display front surface is an easily scratched, plastic polarizer. Avoid contact and clean only when necessary with soft, absorbent cotton dampened with petroleum benzene.
4. Always employ anti-static procedure while handling the module.
5. Prevent moisture build-up upon the module and observe the environmental constraints for storage temperature and humidity.
6. Do not store in direct sunlight
7. If leakage of the liquid crystal material should occur, avoid contact with this material, particularly ingestion. If the body or clothing becomes contaminated by the liquid crystal material, wash thoroughly with water and soap

◆ Storage Precautions

When storing the LCD modules, avoid exposure to direct sunlight or to the light of fluorescent lamps. Keep the modules in bags (avoid high temperature / high humidity and low temperatures below 0°C). Whenever possible, the LCD modules should be stored in the same conditions in which they were shipped from our company.

◆ Others

Liquid crystals solidify under low temperature (below the storage temperature range) leading to defective orientation or the generation of air bubbles (black or white). Air bubbles may also be generated if the module is subject to a low temperature.

If the LCD modules have been operating for a long time showing the same display patterns, the display patterns may remain on the screen as ghost images and a slight contrast irregularity may also appear. A normal operating status can be regained by suspending use for some time. It should be noted that this phenomenon does not adversely affect performance reliability.

To minimize the performance degradation of the LCD modules resulting from destruction caused by static electricity etc., exercise care to avoid holding the following sections when handling the modules.

- Exposed area of the printed circuit board.
- Terminal electrode sections.

■ USING LCD MODULES**◆ Liquid Crystal Display Modules**

LCD is composed of glass and polarizer. Pay attention to the following items when handling.

1. Please keep the temperature within specified range for use and storage. Polarization degradation, bubble generation or polarizer peel-off may occur with high temperature and high humidity.
2. Do not touch, push or rub the exposed polarizers with anything harder than an HB pencil lead (glass, tweezers, etc.).
3. N-hexane is recommended for cleaning the adhesives used to attach front/rear polarizers and reflectors made of organic substances that will be damaged by chemicals such as acetone, toluene, ethanol and isopropylalcohol.
4. When the display surface becomes dusty, wipe gently with absorbent cotton or other soft material like chamois soaked in petroleum benzine. Do not scrub hard to avoid damaging the display surface.
5. Wipe off saliva or water drops immediately, contact with water over a long period of time may cause deformation or color fading.
6. Avoid contacting oil and fats.
7. Condensation on the surface and contact with terminals due to cold will damage, stain or dirty the polarizers. After products are tested at low temperature they must be warmed up in a container before coming in contact with room temperature air.
8. Do not put or attach anything on the display area to avoid leaving marks on.
9. Do not touch the display with bare hands. This will stain the display area and degrade insulation between terminals (some cosmetics are determined to the polarizers).
10. As glass is fragile. It tends to become chipped during handling especially on the edges. Please avoid dropping or jarring.

◆ Installing LCD Modules

1. When assembling the LCM into other equipment, the spacer to the bit between the LCM and the fitting plate should have enough height to avoid causing stress to the module surface, refer to the individual specifications for measurements. The measurement tolerance should be ± 0.1 mm.

◆ Precaution for Handling LCD Modules

Since LCM has been assembled and adjusted with a high degree of precision, avoid applying excessive shocks to the module or making any alterations or modifications to it.

1. Do not alter, modify or change the shape of the tab on the metal frame.
2. Do not make extra holes on the printed circuit board, modify its shape or change the positions of components to be attached.
3. Do not damage or modify the pattern writing on the printed circuit board.
4. Absolutely do not modify the zebra rubber strip (conductive rubber) or heat seal connector.
5. Except for soldering the interface, do not make any alterations or modifications with a soldering iron.
6. Do not drop, bend or twist LCM.

◆ Electro-Static Discharge Control

Since this module uses a CMOS LSI, the same careful attention should be paid to electrostatic discharge as for an ordinary CMOS IC.

1. Make certain that you are grounded when handing LCM.
2. Before remove LCM from its packing case or incorporating it into a set, be sure the module and your body have the same electric potential.
3. When soldering the terminal of LCM, make certain the AC power source for the soldering iron does not leak.
4. When using an electric screwdriver to attach LCM, the screwdriver should be of ground potentiality to minimize as much as possible any transmission of electromagnetic waves produced sparks coming from the commutator of the motor.
5. As far as possible make the electric potential of your work clothes and that of the workbench the ground potential.
6. To reduce the generation of static electricity is careful that the air in the work is not too dried. A relative humidity of 50%-60% is recommended.

◆ Precaution for soldering to the LCM

1. Observe the following when soldering lead wire, connector cable and etc. to the LCM.
 - Soldering iron temperature: $280^{\circ}\text{C} \pm 10^{\circ}\text{C}$.
 - Soldering time: 3-4 sec.
 - Solder: eutectic solder.

If soldering flux is used, be sure to remove any remaining flux after finishing to soldering operation. (This does not apply in the case of a non-halogen type of flux.) It is recommended that you protect the LCD surface with a cover during soldering to prevent any damage due to flux spatters.

2. When soldering the electroluminescent panel and PC board, the panel and board should not be detached more than three times. This maximum number is determined by the temperature and time conditions mentioned above, though there may be some variance depending on the temperature of the soldering iron.
3. When remove the electroluminescent panel from the PC board, be sure the solder has completely melted, the soldered pad on the PC board could be damaged.

◆ Precautions for Operation

1. Viewing angle varies with the change of liquid crystal driving voltage (VO). Adjust VO to show the best contrast.
2. Driving the LCD in the voltage above the limit shortens its life.
3. Response time is greatly delayed at temperature below the operating temperature range. However, this does not mean the LCD will be out of the order. It will recover when it returns to the specified temperature range.
4. If the display area is pushed hard during operation, the display will become abnormal. However, it will return to normal if it is turned off and then back on.
5. Condensation on terminals can cause an electrochemical reaction disrupting the terminal circuit. Therefore, it must be used under the relative condition of 40°C , 50% RH.
6. When turning the power on, input each signal after the positive/negative voltage becomes stable.

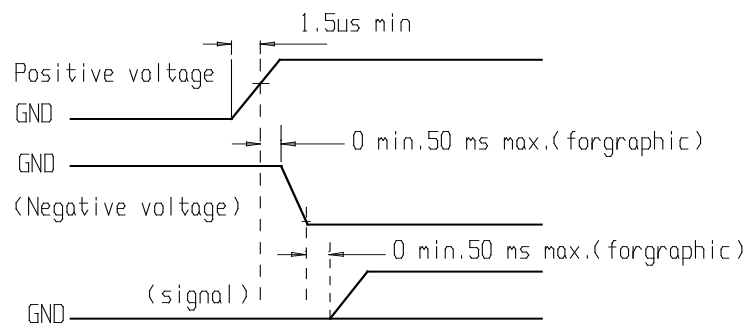

◆ Storage

When storing LCDs as spares for some years, the following precautions are necessary.

1. Store them in a sealed polyethylene bag. If properly sealed, there is no need for desiccant.
2. Store them in a dark place. Do not expose to sunlight or fluorescent light, keep the temperature between 0°C and 35°C.
3. The polarizer surface should not come in contact with any other objects. (We advise you to store them in the container in which they were shipped.)
4. Environmental conditions:
 - Do not leave them for more than 168hrs. at 60°C.
 - Should not be left for more than 48hrs. at -20°C.

◆ Safety

1. It is recommended to crush damaged or unnecessary LCDs into pieces and wash them off with solvents such as acetone and ethanol, which should later be burned.
2. If any liquid leaks out of a damaged glass cell and comes in contact with the hands, wash off thoroughly with soap and water.

◆ Limited Warranty

Unless agreed between DISPLAYTECH and customer, DISPLAYTECH will replace or repair any of its LCD modules that are found to be functionally defective when inspected in accordance with DISPLAYTECH LCD acceptance standards (copies available upon request) for a period of one year from date of shipments. Cosmetic/visual defects must be returned to DISPLAYTECH within 90 days of shipment. Confirmation of such date shall be based on freight documents. The warranty liability of DISPLAYTECH limited to repair and/or replacement on the terms set forth above. DISPLAYTECH will not be responsible for any subsequent or consequential events.

◆ Return LCM under warranty

No warranty can be granted if the precautions stated above have been disregarded. The typical examples of violations are :

- Broken LCD glass.
- PCB eyelet's damaged or modified.
- PCB conductors damaged.
- Circuit modified in any way, including addition of components.
- PCB tampered with by grinding, engraving or painting varnish.
- Soldering to or modifying the bezel in any manner.

Module repairs will be invoiced to the customer upon mutual agreement. Modules must be returned with sufficient description of the failures or defects. Any connectors or cable installed by the customer must be removed completely without damaging the PCB eyelet's, conductors and terminals.

■ REVISION RECORD

VERSION	CHANGES	DATE
1.0	Initial revision	29 July 2008