

# RDS/RBDS decoder

## BU1922/BU1922F

The BU1922 and BU1922F are RDS/RBDS decoders that employ a digital PLL. They have a built-in anti-aliasing filter and an eight-stage BDF (switched-capacitor filter). Linear CMOS circuitry is used for low power consumption.

### ●Applications

RDS/RBDS compatible FM receivers for Europe and North America, car stereo systems, home stereo systems and FM pagers.

### ●Features

- 1) Low power consumption.
- 2) Two-stage anti-aliasing filter (LPF).
- 3) 57kHz bandpass filter (8-stage switched capacitor filter).
- 4) DSB demodulation (digital PLL).
- 5) Quality indication output for demodulated data.

### ●Absolute maximum ratings (Ta = 25°C)

Parameter	Symbol	Limits	Unit	Conditions
Supply voltage	V <sub>DD</sub>	-0.3~+7.0	V	V <sub>DD1</sub> V <sub>DD2</sub>
Maximum input voltage	V <sub>MAX</sub>	-0.3~V <sub>DD</sub> +0.3	V	All input pins
Maximum output current	I <sub>MAX</sub>	±4.0	mA	All input pins
Power dissipation	P <sub>D</sub>	350*	mW	
Operating temperature	T <sub>opr</sub>	-40~+85	°C	
Storage temperature	T <sub>stg</sub>	-55~+125	°C	

\* 1 Reduced by 3.5mW for each increase in Ta of 1°C over 25°C.

\* 2 All output pins.

### ●Recommended operating conditions (Ta = 25°C)

Parameter	Symbol	Min.	Typ.	Max.	Unit
Supply voltage	V <sub>DD1</sub>	4.5	—	5.5	V
	V <sub>DD2</sub>	4.5	—	5.5	V

7828999 0019068 10T

**ROHM**

203

● Block diagram

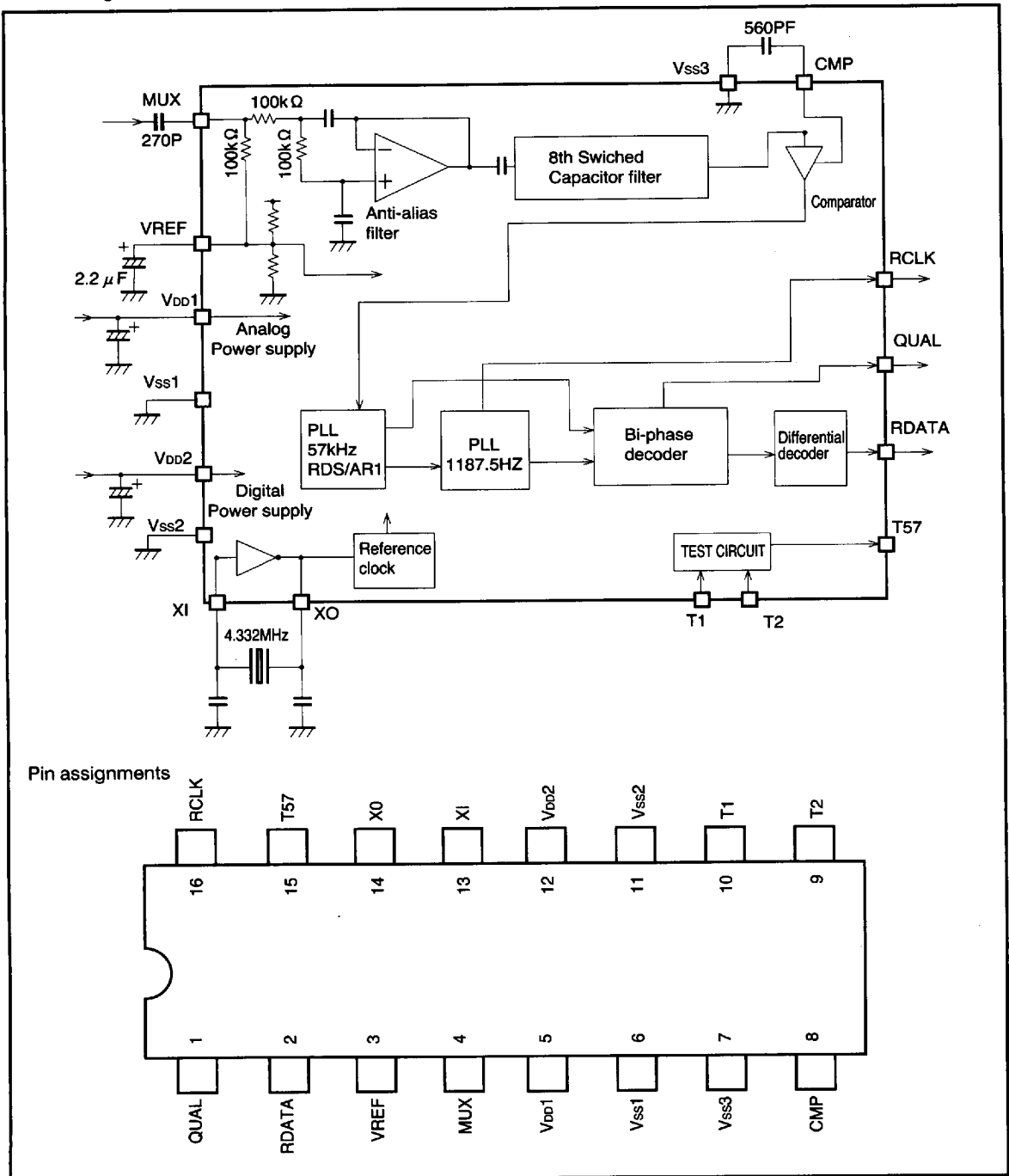

7828999 0019069 046

## ● Pin descriptions

Pin No.	Symbol	Pin name	Function	Input/output type
1	QUAL	Demodulator quality	Good data: HI, bad data: LO	Type E
2	RDATA	Demodulator data	Refer to the timing diagram	
3	VREF	Reference voltage	1/2 VDD1 (refer to the circuit example)	Type G
4	MUX	Input	Composite signal input (refer to the circuit example)	Type F
5	VDD1	Analog power supply	4.5~5.5V	
6	VSS1			
7	CMP	Comparator input	C coupling (refer to the circuit example)	Type F
8	VSS3	GND		
9	T2	Test input	Open or connected to ground	Type B
10	T1			
11	VDD2	Digital power supply	4.5~5.5V	
12	VSS2			
13	XI	Crystal oscillator	Connects to 4.332MHz oscillator (refer to the circuit example)	Type A
14	XO			
15	T57	Test output	Open	Type E
16	RCLK	Reset	1187.5kHz clock (refer to the timing diagram)	

■ 7828999 0019070 868 ■

**ROHM**

205

● Input/output circuit

Type A

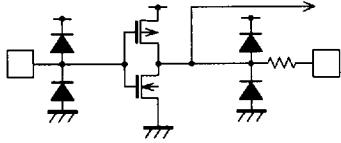

Type B

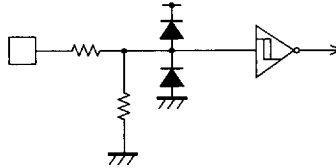

Type C

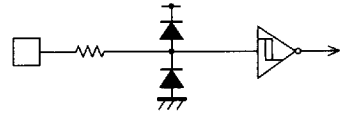

Type D

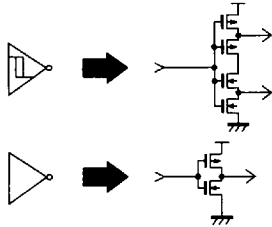

Type E

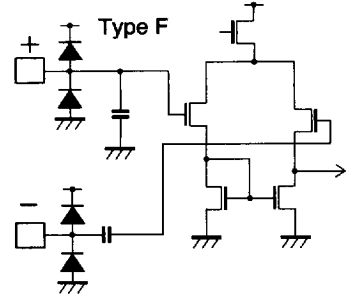
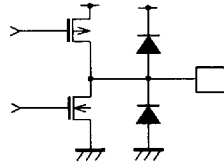

Type G

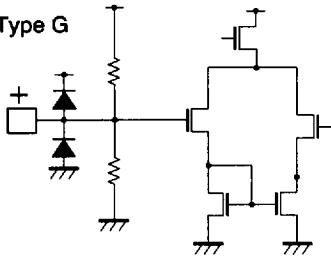

Type H

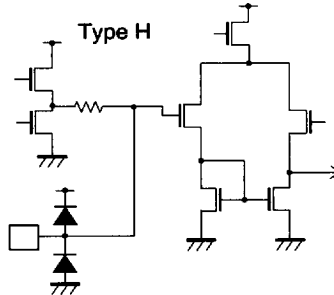

Type I

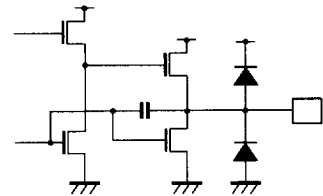

7828999 0019071 7T4

●Electrical characteristics (unless otherwise specified Ta = 25°C, V<sub>DD1</sub> = V<sub>DD2</sub> = 5.0V, V<sub>SS1</sub> = V<sub>SS2</sub> = 0.0V)

Parameter	Symbol	Min.	Typ.	Max.	Unit	Conditions
Operating current	I <sub>DD</sub>	—	4.5	7.0	mA	I <sub>DD1</sub> + I <sub>DD2</sub>
Reference voltage	V <sub>REF</sub>	—	1/2V <sub>DD1</sub>	—	V	Pin 3
Input current 1	I <sub>IN1</sub>	—	—	1.0	μA	MUX V <sub>IN</sub> =V <sub>DD1</sub>
Output current 1	I <sub>OUT1</sub>	—	—	1.0	μA	MUX V <sub>IN</sub> =V <sub>DD1</sub>
Input current 2	I <sub>IN2</sub>	—	—	1.0	μA	XI V <sub>IN</sub> =V <sub>DD2</sub>
Output current 2	I <sub>OUT2</sub>	—	—	1.0	μA	XI V <sub>IN</sub> =V <sub>DD2</sub>
"L" level output voltage 1	V <sub>OL1</sub>	V <sub>DD2</sub> -1.0	V <sub>DD2</sub> -0.3	—	V	RCLK RDATA QUAL I <sub>O</sub> =-1.0mA
"H" level output voltage 1	V <sub>OH1</sub>	—	0.2	1.0	V	RCLK RDATA QUAL I <sub>O</sub> =1.0mA

## Filter block

Parameter	Symbol	Min.	Typ.	Max.	Unit	Conditions
Center frequency	FC	56.5	57.0	57.5	kHz	
Gain	GA	23	26	29	dB	F=57.0kHz
Attenuation 1	ATT1	18	22		dB	57kHz±4kHz
Attenuation 2	ATT2	65	80		dB	38kHz
Attenuation 3	ATT3	35	50		dB	67kHz
S/N ratio	SN	30	40		dB	57kHz V <sub>IN</sub> =3mVrms
Maximum input level	VMAX1			500	mVrms	

## Demodulator block

Parameter	Symbol	Min.	Typ.	Max.	Unit	Conditions
RDS detector sensitivity	SRDS	—	0.5	1.0	mVrms	
RDS maximum input level	MRDS	—	—	300	mVrms	
ARI detector sensitivity	SARI	—	1.5	3.0	mVrms	
Data rate	DRATE	—	1187.5	—	Hz	
Clock transient vs. data	CT	—	4.3	—	μs	

©Circuit is not designed for radiation resistance.

7828999 0019072 630

**ROHM**

207

●Output data timing

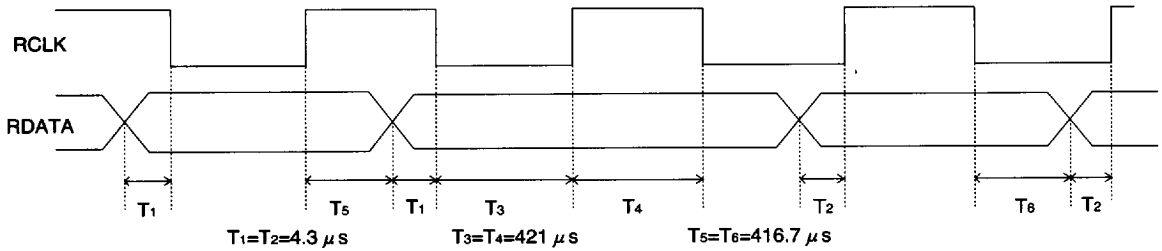

The clock (RCLK) frequency is 1187.5Hz. Depending on the state of the internal PLL clock, the data (RDATA) is replaced in synchronous with either the rising or falling edge of the clock. To read the data, you may

choose either the rising or falling edge of the clock as the reference. The data is valid for 416.7μsec. after the reference clock edge.

QUAL pin operation : Indicates the quality of the demodulated data.

- (1) Good data : HI
- (2) Poor data : LO

●Electrical characteristics curve

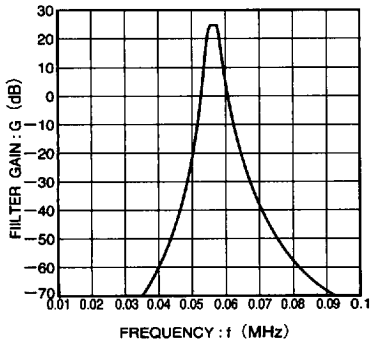
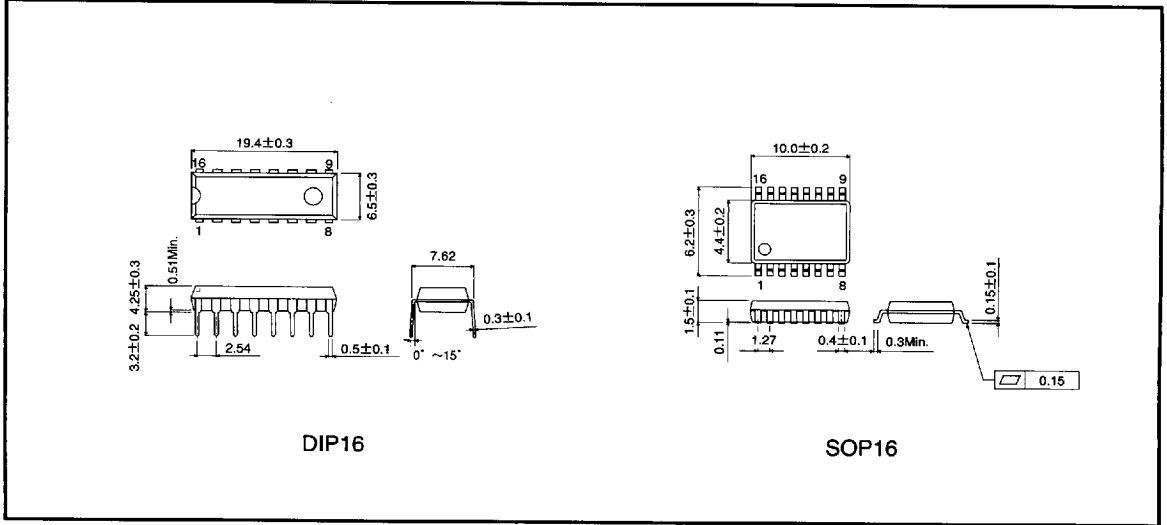

Fig. 1 Bandpass filter characteristics

7828999 0019073 577

● External dimensions (Unit: mm)



DIP16

SOP16

7828999 0019074 403

**ROHM**