



## ispXPGA<sup>®</sup> Device Datasheet

June 2010

# Select Devices Discontinued!

Product Change Notifications (PCNs) have been issued to discontinue select devices in this data sheet.

The original datasheet pages have not been modified and do not reflect those changes. Please refer to the table below for reference PCN and current product status.

| Product Line | Ordering Part Number | Product Status     | Reference PCN             |
|--------------|----------------------|--------------------|---------------------------|
| LFX125B      | LFX125B-03F256C      | Discontinued       | <a href="#">PCN#09-10</a> |
|              | LFX125B-03FN256C     |                    |                           |
|              | LFX125B-04F256C      |                    |                           |
|              | LFX125B-04FN256C     |                    |                           |
|              | LFX125B-05F256C      |                    |                           |
|              | LFX125B-05FN256C     |                    |                           |
|              | LFX125B-03F516C      |                    |                           |
|              | LFX125B-04F516C      |                    |                           |
| LFX125C      | LFX125C-03F256C      | Discontinued       | <a href="#">PCN#09-10</a> |
|              | LFX125C-03FN256C     |                    |                           |
|              | LFX125C-04F256C      |                    |                           |
|              | LFX125C-04FN256C     |                    |                           |
|              | LFX125C-03F516C      |                    |                           |
|              | LFX125C-04F516C      |                    |                           |
| LFX200B      | LFX200B-03F256C      | Active / Orderable | <a href="#">PCN#09-10</a> |
|              | LFX200B-03FN256C     |                    |                           |
|              | LFX200B-04F256C      |                    |                           |
|              | LFX200B-04FN256C     |                    |                           |
|              | LFX200B-05F256C      | Discontinued       |                           |
|              | LFX200B-05FN256C     |                    |                           |
|              | LFX200B-03F516C      |                    |                           |
|              | LFX200B-04F516C      |                    |                           |
| LFX200C      | LFX200C-03F256C      | Discontinued       | <a href="#">PCN#09-10</a> |
|              | LFX200C-03FN256C     |                    |                           |
|              | LFX200C-04F256C      |                    |                           |
|              | LFX200C-04FN256C     |                    |                           |
|              | LFX200C-03F516C      |                    |                           |
|              | LFX200C-04F516C      |                    |                           |



| Product Line     | Ordering Part Number | Product Status     | Reference PCN              |
|------------------|----------------------|--------------------|----------------------------|
| LFX500B          | LFX500B-03F516C      | Discontinued       | <a href="#">PCN#09-10</a>  |
|                  | LFX500B-04F516C      |                    |                            |
|                  | LFX500B-05F516C      |                    |                            |
|                  | LFX500B-03F900C      |                    |                            |
|                  | LFX500B-03FN900C     |                    |                            |
|                  | LFX500B-04F900C      |                    |                            |
|                  | LFX500B-04FN900C     |                    |                            |
|                  | LFX500B-05F900C      |                    |                            |
| LFX500C          | LFX500C-03F516C      | Discontinued       | <a href="#">PCN#09-10</a>  |
|                  | LFX500C-04F516C      |                    |                            |
|                  | LFX500C-03F900C      |                    |                            |
|                  | LFX500C-03FN900C     |                    |                            |
|                  | LFX500C-04F900C      |                    |                            |
|                  | LFX500C-04FN900C     |                    |                            |
| LFX1200B         | LFX1200B-03FE680C    | Discontinued       | <a href="#">PCN#03A-10</a> |
|                  | LFX1200B-04FE680C    |                    |                            |
|                  | LFX1200B-05FE680C    |                    |                            |
|                  | LFX1200B-03F900C     |                    |                            |
|                  | LFX1200B-04F900C     |                    |                            |
| LFX1200C         | LFX1200C-03FE680C    | Discontinued       | <a href="#">PCN#03A-10</a> |
|                  | LFX1200C-04FE680C    |                    |                            |
|                  | LFX1200C-03F900C     |                    |                            |
|                  | LFX1200C-04F900C     |                    |                            |
| LFX125EB         | LFX125EB-03F256C     | Active / Orderable |                            |
|                  | LFX125EB-03FN256C    |                    |                            |
|                  | LFX125EB-04F256C     |                    |                            |
|                  | LFX125EB-04FN256C    |                    |                            |
|                  | LFX125EB-05F256C     |                    |                            |
|                  | LFX125EB-05FN256C    |                    |                            |
|                  | LFX125EB-03F256I     |                    |                            |
|                  | LFX125EB-03FN256I    |                    |                            |
|                  | LFX125EB-04F256I     | Discontinued       |                            |
|                  | LFX125EB-04FN256I    |                    |                            |
|                  | LFX125EB-03F516C     |                    |                            |
|                  | LFX125EB-04F516C     |                    |                            |
|                  | LFX125EB-05F516C     |                    |                            |
|                  | LFX125EB-03F516I     |                    |                            |
| LFX125EB-04F516I |                      |                    |                            |
| LFX125EC         | LFX125EC-03F256C     | Discontinued       | <a href="#">PCN#09-10</a>  |
|                  | LFX125EC-03FN256C    |                    |                            |
|                  | LFX125EC-04F256C     |                    |                            |
|                  | LFX125EC-04FN256C    |                    |                            |
|                  | LFX125EC-03F256I     |                    |                            |
|                  | LFX125EC-03FN256I    |                    |                            |



| Product Line                 | Ordering Part Number | Product Status            | Reference PCN             |
|------------------------------|----------------------|---------------------------|---------------------------|
| <b>LFX125EC<br/>(Cont'd)</b> | LFX125EC-03F516C     | <b>Discontinued</b>       | <a href="#">PCN#09-10</a> |
|                              | LFX125EC-04F516C     |                           |                           |
|                              | LFX125EC-03F516I     |                           |                           |
| <b>LFX200EB</b>              | LFX200EB-03F256C     | <b>Active / Orderable</b> |                           |
|                              | LFX200EB-03FN256C    |                           |                           |
|                              | LFX200EB-04F256C     |                           |                           |
|                              | LFX200EB-04FN256C    |                           |                           |
|                              | LFX200EB-05F256C     |                           |                           |
|                              | LFX200EB-05FN256C    |                           |                           |
|                              | LFX200EB-03F256I     |                           |                           |
|                              | LFX200EB-03FN256I    |                           |                           |
|                              | LFX200EB-04F256I     |                           |                           |
|                              | LFX200EB-04FN256I    |                           |                           |
|                              | LFX200EB-03F516C     |                           |                           |
|                              | LFX200EB-04F516C     |                           |                           |
|                              | LFX200EB-05F516C     |                           |                           |
|                              | LFX200EB-03F516I     |                           |                           |
| LFX200EB-04F516I             |                      |                           |                           |
| <b>LFX200EC</b>              | LFX200EC-03F256C     | <b>Discontinued</b>       | <a href="#">PCN#09-10</a> |
|                              | LFX200EC-03FN256C    |                           |                           |
|                              | LFX200EC-04F256C     |                           |                           |
|                              | LFX200EC-04FN256C    |                           |                           |
|                              | LFX200EC-03F256I     |                           |                           |
|                              | LFX200EC-03FN256I    |                           |                           |
|                              | LFX200EC-03F516C     |                           |                           |
|                              | LFX200EC-04F516C     |                           |                           |
|                              | LFX200EC-03F516I     |                           |                           |
| <b>LFX500EB</b>              | LFX500EB-03F516C     | <b>Discontinued</b>       | <a href="#">PCN#09-10</a> |
|                              | LFX500EB-04F516C     |                           |                           |
|                              | LFX500EB-05F516C     |                           |                           |
|                              | LFX500EB-03F516I     |                           |                           |
|                              | LFX500EB-04F516I     |                           |                           |
|                              | LFX500EB-03F900C     |                           |                           |
|                              | LFX500EB-03FN900C    |                           |                           |
|                              | LFX500EB-04F900C     |                           |                           |
|                              | LFX500EB-04FN900C    |                           |                           |
|                              | LFX500EB-05F900C     |                           |                           |
|                              | LFX500EB-05FN900C    |                           |                           |
|                              | LFX500EB-03F900I     |                           |                           |
|                              | LFX500EB-03FN900I    |                           |                           |
|                              | LFX500EB-04F900I     |                           |                           |
| LFX500EB-04FN900I            |                      |                           |                           |
| <b>LFX500EC</b>              | LFX500EC-03F516C     | <b>Discontinued</b>       | <a href="#">PCN#09-10</a> |
|                              | LFX500EC-04F516C     |                           |                           |
|                              | LFX500EC-03F516I     |                           |                           |



| Product Line                 | Ordering Part Number | Product Status      | Reference PCN              |
|------------------------------|----------------------|---------------------|----------------------------|
| <b>LFX500EC<br/>(Cont'd)</b> | LFX500EC-03F900C     | <b>Discontinued</b> | <a href="#">PCN#09-10</a>  |
|                              | LFX500EC-03FN900C    |                     |                            |
|                              | LFX500EC-04F900C     |                     |                            |
|                              | LFX500EC-04FN900C    |                     |                            |
|                              | LFX500EC-03F900I     |                     |                            |
|                              | LFX500EC-03FN900I    |                     |                            |
| <b>LFX1200EB</b>             | LFX1200EB-03FE680C   | <b>Discontinued</b> | <a href="#">PCN#03A-10</a> |
|                              | LFX1200EB-04FE680C   |                     |                            |
|                              | LFX1200EB-05FE680C   |                     |                            |
|                              | LFX1200EB-03FE680I   |                     |                            |
|                              | LFX1200EB-04FE680I   |                     |                            |
|                              | LFX1200EB-03F900C    |                     |                            |
|                              | LFX1200EB-04F900C    |                     |                            |
|                              | LFX1200EB-05F900C    |                     |                            |
|                              | LFX1200EB-03F900I    |                     |                            |
|                              | LFX1200EB-04F900I    |                     |                            |
| <b>LFX1200EC</b>             | LFX1200EC-03FE680C   | <b>Discontinued</b> | <a href="#">PCN#03A-10</a> |
|                              | LFX1200EC-04FE680C   |                     |                            |
|                              | LFX1200EC-03FE680I   |                     |                            |
|                              | LFX1200EC-03F900C    |                     |                            |
|                              | LFX1200EC-04F900C    |                     |                            |
|                              | LFX1200EC-03F900I    |                     |                            |



- Non-volatile, Infinitely Reconfigurable**
  - Instant-on - Powers up in microseconds via on-chip E<sup>2</sup>CMOS® based memory
  - No external configuration memory
  - Excellent design security, no bit stream to intercept
  - Reconfigure SRAM based logic in milliseconds
- High Logic Density for System-level Integration**
  - 139K to 1.25M functional gates
  - 160 to 496 I/O
  - 1.8V, 2.5V, and 3.3V V<sub>CC</sub> operation
  - Up to 414Kb sysMEM™ embedded memory
- High Performance Programmable Function Unit (PFU)**
  - Four LUT-4 per PFU supports wide and narrow functions
  - Dual flip-flops per LUT-4 for extensive pipelining
  - Dedicated logic for adders, multipliers, multiplexers, and counters
- Flexible Memory Resources**
  - Multiple sysMEM Embedded RAM Blocks
    - Single port, Dual port, and FIFO operation
  - 64-bit distributed memory in each PFU
    - Single port, Double port, FIFO, and Shift Register operation
- Flexible Programming, Reconfiguration, and Testing**
  - Supports IEEE 1532 and 1149.1
- Microprocessor configuration interface
  - Program E<sup>2</sup>CMOS while operating from SRAM
- Eight sysCLOCK™ Phase Locked Loops (PLLs) for Clock Management**
  - True PLL technology
  - 10MHz to 320MHz operation
  - Clock multiplication and division
  - Phase adjustment
  - Shift clocks in 250ps steps
- sysIO™ for High System Performance**
  - High speed memory support through SSTL and HSTL
  - Advanced buses supported through PCI, GTL+, LVDS, BLVDS, and LVPECL
  - Standard logic supported through LVTTTL, LVCMOS 3.3, 2.5 and 1.8
  - 5V tolerant I/O for LVCMOS 3.3 and LVTTTL interfaces
  - Programmable drive strength for series termination
  - Programmable bus maintenance
- Two Options Available**
  - High-performance sysHSI (standard part number)
  - Low-cost, no sysHSI (“E-Series”)
- sysHSI™ Capability for Ultra Fast Serial Communications**
  - Up to 800Mbps performance
  - Up to 20 channels per device
  - Built in Clock Data Recovery (CDR) and Serialization and De-serialization (SERDES)

**Table 1. ispXPGA Family Selection Guide**

|                              | ispXPGA 125/E                       | ispXPGA 200/E                       | ispXPGA 500/E                           | ispXPGA 1200/E <sup>3</sup> |
|------------------------------|-------------------------------------|-------------------------------------|-----------------------------------------|-----------------------------|
| Functional Gates             | 139K                                | 210K                                | 476K                                    | 1.25M                       |
| PFUs                         | 484                                 | 676                                 | 1764                                    | 3844                        |
| LUT-4s                       | 1936                                | 2704                                | 7056                                    | 15376                       |
| Logic FFs                    | 3.8K                                | 5.4K                                | 14.1K                                   | 30.7K                       |
| sysMEM Memory                | 92K                                 | 111K                                | 184K                                    | 414K                        |
| Distributed Memory           | 30K                                 | 43K                                 | 112K                                    | 246K                        |
| EBR                          | 20                                  | 24                                  | 40                                      | 90                          |
| sysHSI Channels <sup>1</sup> | 4                                   | 8                                   | 12                                      | 20                          |
| User I/O                     | 160/176                             | 160/208                             | 336                                     | 496                         |
| Packaging                    | 256 fpBGA<br>516 fpBGA <sup>2</sup> | 256 fpBGA<br>516 fpBGA <sup>2</sup> | 516 fpBGA <sup>2</sup><br><br>900 fpBGA | 680 fpSBGA<br>900 fpBGA     |

1. “E-Series” does not support sysHSI.  
 2. FH516 package was converted to F516 via [PCN #09A-08](#).  
 3. Discontinued via [PCN #03A-10](#).

## ispXPGA Family Overview

The ispXPGA family of devices provides the ideal vehicle for the creation of high-performance logic designs that are both non-volatile and infinitely re-programmable. Other FPGA solutions force a compromise, being either re-programmable or non-volatile. This family couples this capability with a mainstream architecture containing the features required for today’s system-level design.

The ispXPGA family is available in two options. The standard device supports sysHSI capability for ultra fast serial communications while the lower-cost “E-Series” supports the same high-performance FPGA fabric without the sysHSI Block.

Electrically Erasable CMOS (E<sup>2</sup>CMOS) memory cells provide the ispXPGA family with non-volatile capability. These allow logic to be functional microseconds after power is applied, allowing easy interfacing in many applications. This capability also means that expensive external configuration memories are not required and that designs can be secured from unauthorized read back. Internal SRAM cells allow the device to be infinitely reconfigured if desired. Both the SRAM and E<sup>2</sup>CMOS cells can be programmed and verified through the IEEE 1532 industry standard. Additionally, the SRAM cells can be configured and read-back through the sysCONFIG™ peripheral port.

The family spans the density and I/O range required for the majority of today’s logic designs, 139K to 1.25M functional gates and 160 to 496 I/O. The devices are available for operation from 1.8V, 2.5V, and 3.3V power supplies, providing easy integration into the overall system.

System-level design needs are met through the incorporation of sysMEM dual-port memory blocks, sysIO advanced I/O support, and sysCLOCK Phase Locked Loops (PLLs). High-speed serial communications are supported through multiple sysHSI blocks, which provide clock data recovery (CDR) and serialization/de-serialization (SERDES).

The ispLEVER™ design tool from Lattice allows easy implementation of designs using the ispXPGA product. Synthesis library support is available for major logic synthesis tools. The ispLEVER tool takes the output from these common synthesis packages and place and routes the design in the ispXPGA product. The tool supports floor planning and the management of other constraints within the device. The tool also provides outputs to common timing analysis tools for timing analysis.

To increase designer productivity, Lattice provides a variety of pre-designed modules referred to as IP cores for the ispXPGA product. These IP cores allow designers to concentrate on the unique portions of their design while using pre-designed blocks to implement standard functions such as bus interfaces, standard communication interfaces, and memory controllers.

Through the use of advanced technology and innovative architecture the ispXPGA FPGA devices provide designers with excellent speed performance. Although design dependent, many typical designs can run at over 150MHz. Certain designs can run at over 300MHz. Table 2 details the performance of several building blocks commonly used by logic designers.

**Table 2. ispXPGA Speed Performance for Typical Building Blocks**

| Function                        | Performance |
|---------------------------------|-------------|
| 8:1 Asynch MUX                  | 150 MHz     |
| 1:32 Asynch Demultiplexer       | 125 MHz     |
| 8 x 8 2-LL Pipelined Multiplier | 225 MHz     |
| 32-bit Up/Down Counter          | 290 MHz     |
| 32-bit Shift Register           | 360 MHz     |

---

## Architecture Overview

The ispXPGA architecture is a symmetrical architecture consisting of an array of Programmable Function Units (PFUs) enclosed by Input Output Groups (PICs) with columns of sysMEM Embedded Block RAMs (EBRs) distributed throughout the array. Figure 1 illustrates the ispXPGA architecture. Each PIC has two corresponding sysIO blocks, each of which includes one input and output buffer. On two sides of the device, between the PICs and the sysIO blocks, there are sysHSI High-Speed Interface blocks. The symmetrical architecture allows designers to easily implement their designs, since any logic function can be placed in any section of the device.

The PFUs contain the basic building blocks to create logic, memory, arithmetic, and register functions. They are optimized for speed and flexibility allowing complex designs to be implemented quickly and efficiently.

The PICs interface the PFUs and EBRs to the external pins of the device. They allow the signals to be registered quickly to minimize setup times for high-speed designs. They also allow connections directly to the different logic elements for fast access to combinatorial functions.

The sysMEM EBRs are large, fast memory elements that can be configured as RAM, ROM, FIFO, and other storage types. They are designed to facilitate both single and dual-port memory for high-speed applications.

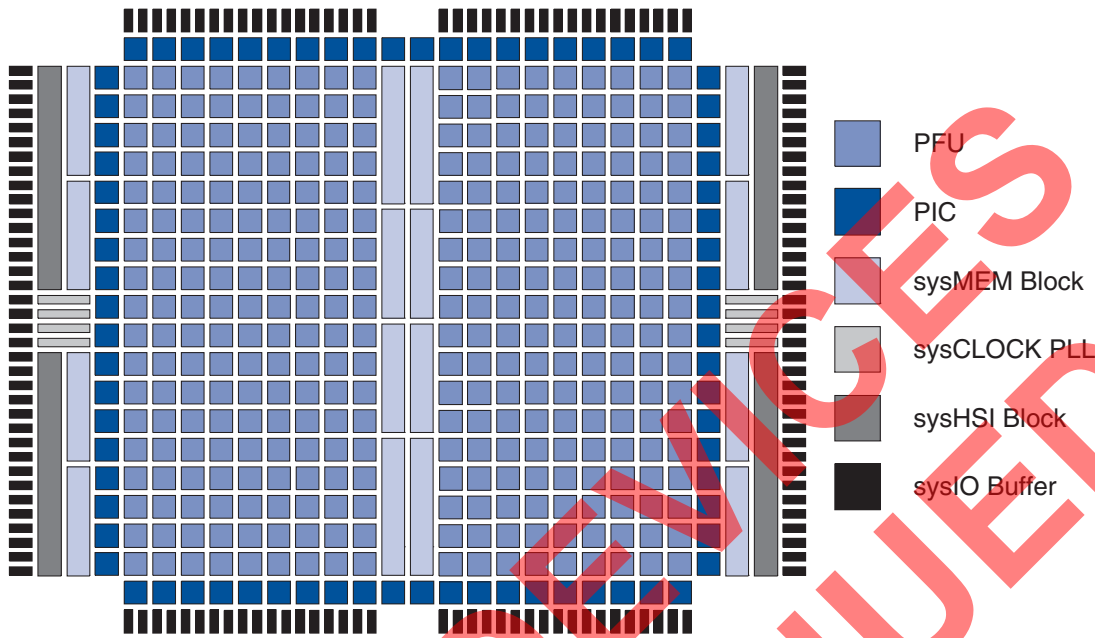
These three components of the architecture are interconnected via a high-speed, flexible routing array. The routing array consists of Variable Length Interconnect (VLI) lines between the PICs, PFUs, and EBRs. There is additional routing available to the PFU for feedback and direct routing of signals to adjacent PFUs or PICs.

The sysIO blocks consist of configurable input and output buffers connected directly to the PICs. These buffers can be configured to interface with 16 different I/O standards. This allows the ispXPGA to interface with other devices without the need for external transceivers.

The sysHSI blocks provide the necessary components to allow the ispXPGA device to transfer data at up to 800Mbps using the LVDS standard. These components include serializing, de-serializing, and clock data recovery (CDR) logic.

The sysCLOCK blocks provide clock multiplication/division, clock distribution, delay compensation, and increased performance through the use of PLL circuitry that manipulates the global clocks. There is one sysCLOCK block for each global clock tree in the device.

Figure 1. ispXPGA Block Diagram



**Programmable Function Unit**

The Programmable Function Unit (PFU) is the basic building block of the ispXPGA architecture. The PFUs are arranged in rows and columns in the device with PFU (1,1) referring to (row 1, column 1). Each PFU consists of four Configurable Logic Elements (CLEs), four Configurable Sequential Elements (CSEs), and a Wide Logic Generator (WLG). By utilizing these components, the PFU can implement a variety of functions. Table 3 lists some of the function capabilities of the PFU.

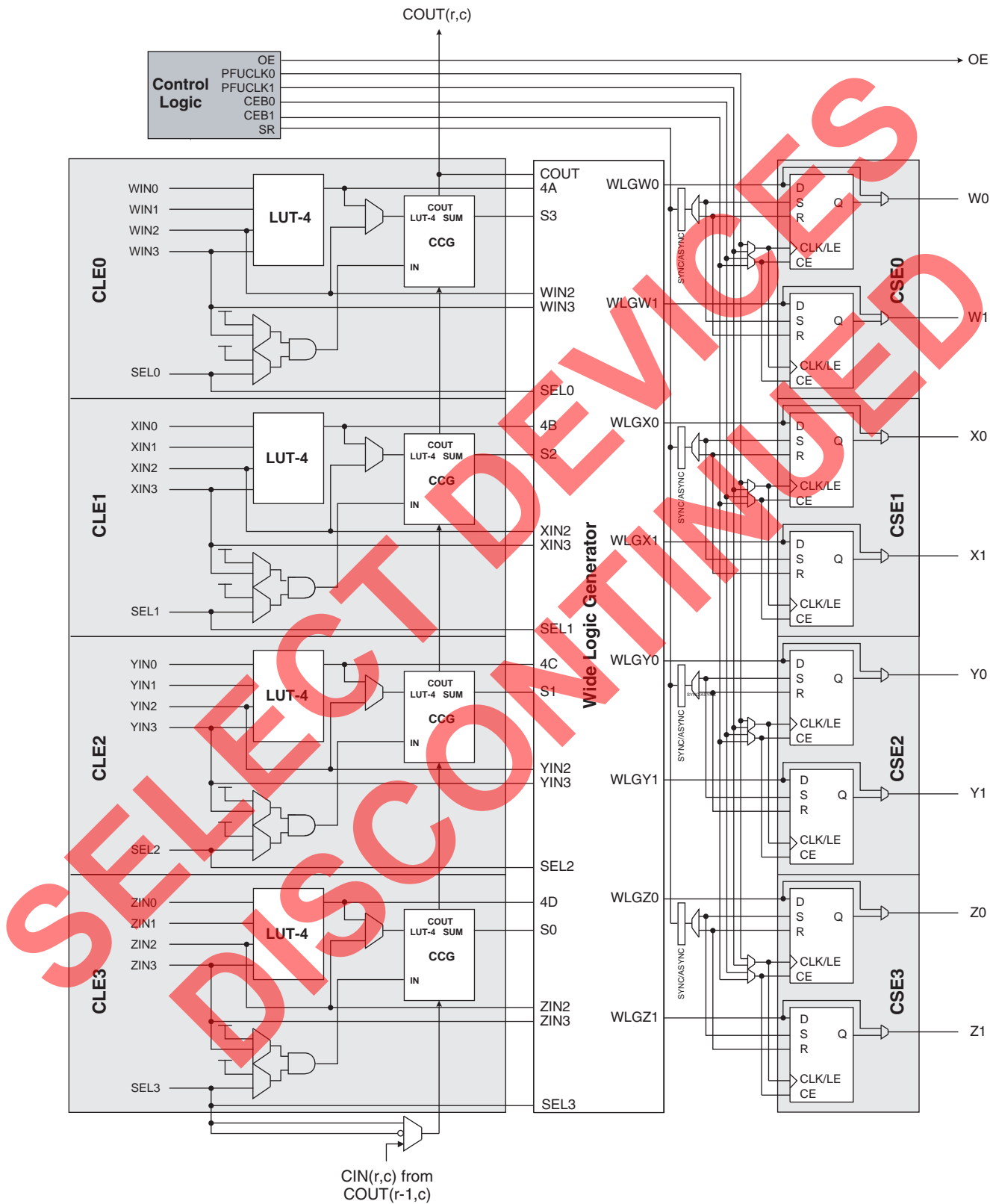
There are 57 inputs to each PFU and nine outputs. The PFU uses 20 inputs for logic, and 37 inputs drive the control logic from which six control signals are derived for the PFU.

**Table 3. Function Capability of ispXPGA PFU**

| Function             | Capability                                            |
|----------------------|-------------------------------------------------------|
| Look-up table        | LUT-4, LUT-5, LUT-6                                   |
| Wide logic functions | Up to 20 input logic functions                        |
| Multiplexing         | 2:1, 4:1, 8:1                                         |
| Arithmetic logic     | Dedicated carry chain and booth multiplication logic  |
| Single-port RAM      | 16X1, 16X2, 16X4, 32X1, 32X2, 64X1                    |
| Double-port RAM      | 16X1, 16X2, 32X1                                      |
| Shift register       | 8-bit shift registers (up to 32-bit shift capability) |



Figure 2. ispXPGA PFU



**Configurable Logic Element**

The CLE is made up of a four-input Look-up Table (LUT-4), a Carry Chain Generator (CCG), and a two-input AND gate. The LUT-4 creates various combinatorial and memory elements, the CCG creates a single one-bit full adder, and the two-input AND gate can expand the CCG to incorporate Booth Multiplier capability by feeding the output of the AND gate to one of the inputs of the CCG.

Of the five inputs that feed each CLE, two are dedicated inputs into each LUT-4 and the remaining three take on varying functionality. The third and fourth inputs can be used as either inputs to the LUT-4 or as a Feed-Thru to the CSE via the WLG. The fifth input can be a data port when the LUT is configured as Distributed Memory, a select line for multiplexer operation, or a Feed-Thru directly to the CSE via the WLG (Figure 2).

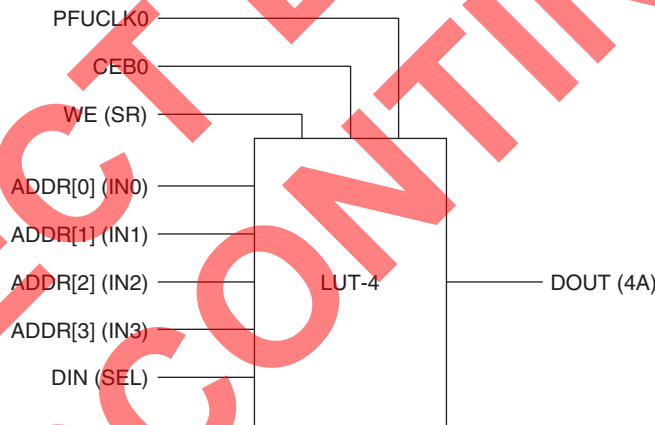
**Look-Up Table – Combinatorial Mode**

In combinatorial mode, the LUT-4 can implement any logic function up to four inputs. By using the carry chain and the WLG, each LUT-4 can be combined to form the enhanced functions listed in Table 3.

**Look-Up Table – Distributed Memory Mode**

In the distributed memory mode, the LUT functions as a memory element. The inputs to the LUT function as Address and Data. Each PFU is capable of implementing up to 64 SRAM bits. Both single and double port RAM can be performed in the PFU (Table 3). Furthermore, the distributed memory can be configured as either synchronous or asynchronous memory. Figure 3 illustrates the LUT while in distributed memory mode. When using any LUT in the PFU in memory mode, the Set/Reset signal will be used for Write Enable (WE(SR)) and the CLK0 signal will be used as the clock for synchronous read and write.

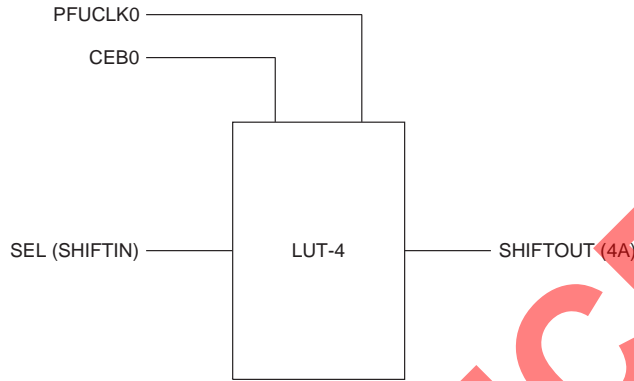
**Figure 3. LUT in Distributed Memory Mode**



**Look-Up Table – Shift Register Mode**

In the shift register mode, the LUT functions as a 1-bit to 8-bit shift register. This means that each PFU can implement up to four 8-bit shift registers or any cascaded combination. Figure 4 illustrates the LUT when configured in shift register mode.

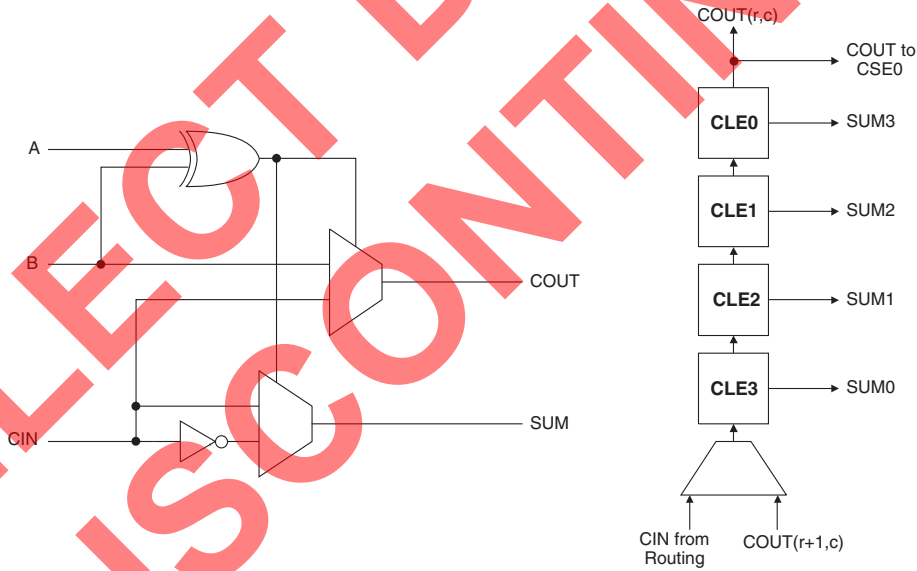
Figure 4. LUT in Shift Register Mode



**Carry Chain Generator**

The Carry Chain Generator is useful for implementing high-speed arithmetic functions. The CCG consists of a two-input XOR gate whose carryout can be cascaded with the input of the adjacent CCG. As shown in Figure 5, the carryin signal feeds CLE3 of the PFU and is propagated through CLE2 and CLE1 before reaching CLE0. The sum output of the CCG can be fed to the CSE through the WLG. The carryout must propagate to CLE0 for use outside the PFU. The carryout from the PFU can feed the W0 input of CSE0. The CCG also helps to effectively implement wider functions by using its logic elements to expand the capabilities of the LUT-4.

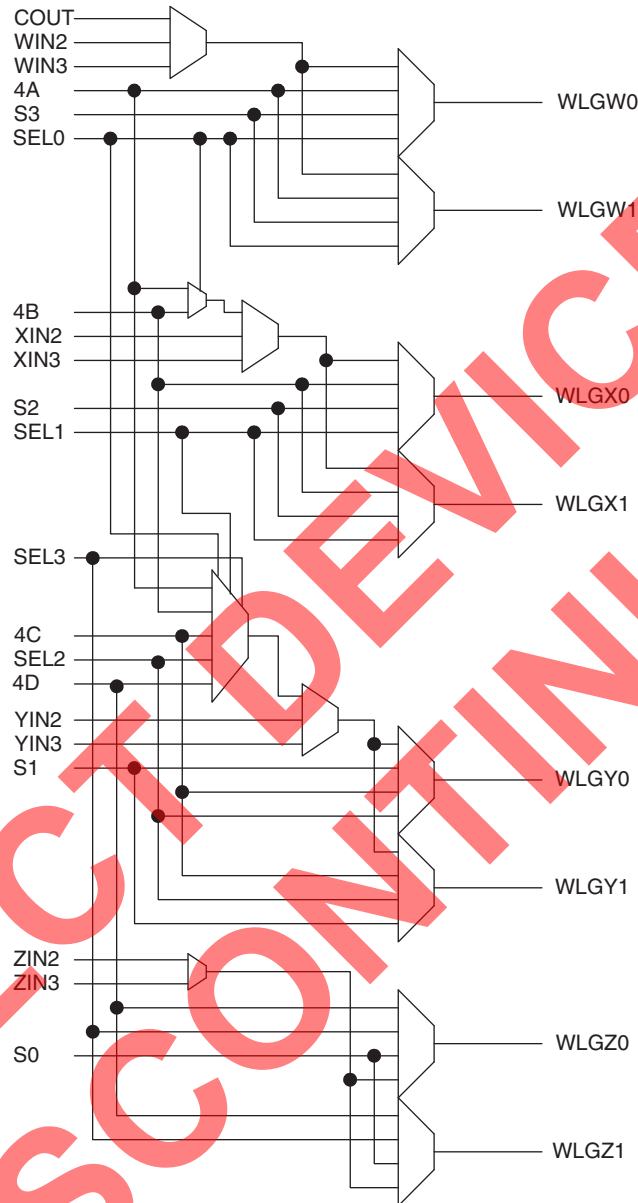
Figure 5. Carry Chain Generator



**Wide Logic Generator**

The WLG contains the logic necessary to implement wide gate functions. This is made up of a set of multiplexers that are located between the CLE and the CSE. The WLG helps in enhancing the wide gating capability of the PFU. The outputs of each CLE can be cascaded in the WLG to build wide gating functions. Wide multiplexing functions are also possible with a similar use of the WLG. Figure 6 illustrates the WLG.

Figure 6. ispXPGA Wide Logic Generator



**Configurable Sequential Element**

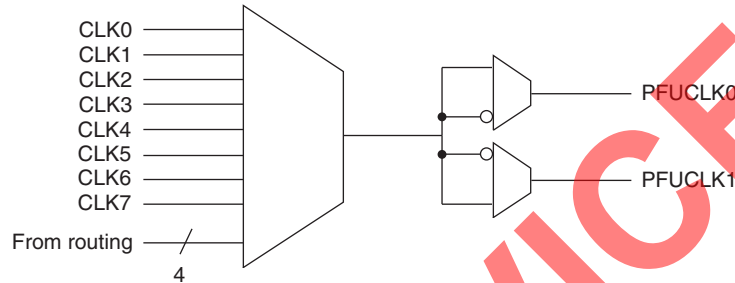
There are two registers in each CSE for a total of eight registers in each PFU. This high register count assists in implementing efficient pipelined applications with no utilization penalty. Each register can be configured as a latch or D type flip-flop with either synchronous or asynchronous set or reset. Figure 2 shows the signals that feed the register’s D inputs. Feed-through signals in the architecture ensure that registers are efficiently utilized even if the accompanying LUT is occupied.

**Control Logic**

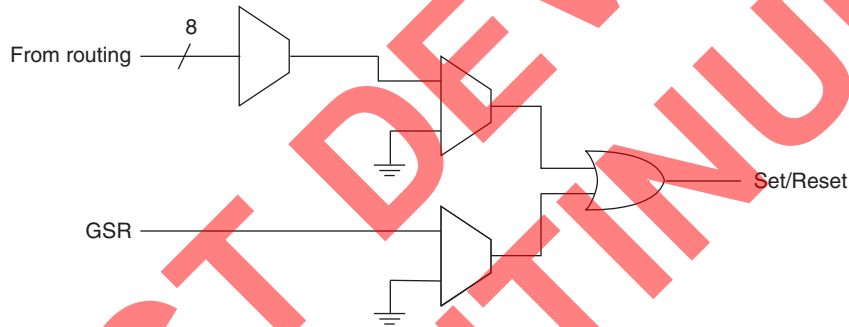
The control signals available to the registers in a PFU are Clock, Clock Enable, and Set/Reset. Figure 7 shows the various options available to generate the clock signal. As can be seen, the clock signal is the output of a 12:1 MUX with true and complement versions available from the 12:1 MUX. Each CSE can chose whether it uses the true or complement form of the clock. Figure 8 shows the Set/Reset selection for each PFU in the ispXPGA. A common

Set/Reset signal controls all the registers for each PFU. This common Set/Reset signal is composed of the logical OR term of the Global Set/Reset signal (GSR) and the selected signal from routing. The polarity of this signal is not controllable inside the PFU. The polarity of the Global Set/Reset signal (GSR) is programmable. Figure 9 shows the Clock Enable and Output Enable selection for each PFU.

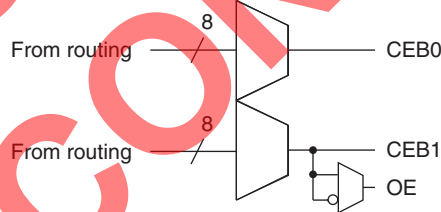
**Figure 7. Clock Selection per PFU**



**Figure 8. Set/Reset Selection per PFU**



**Figure 9. Clock Enable and Output Enable Selection per PFU**

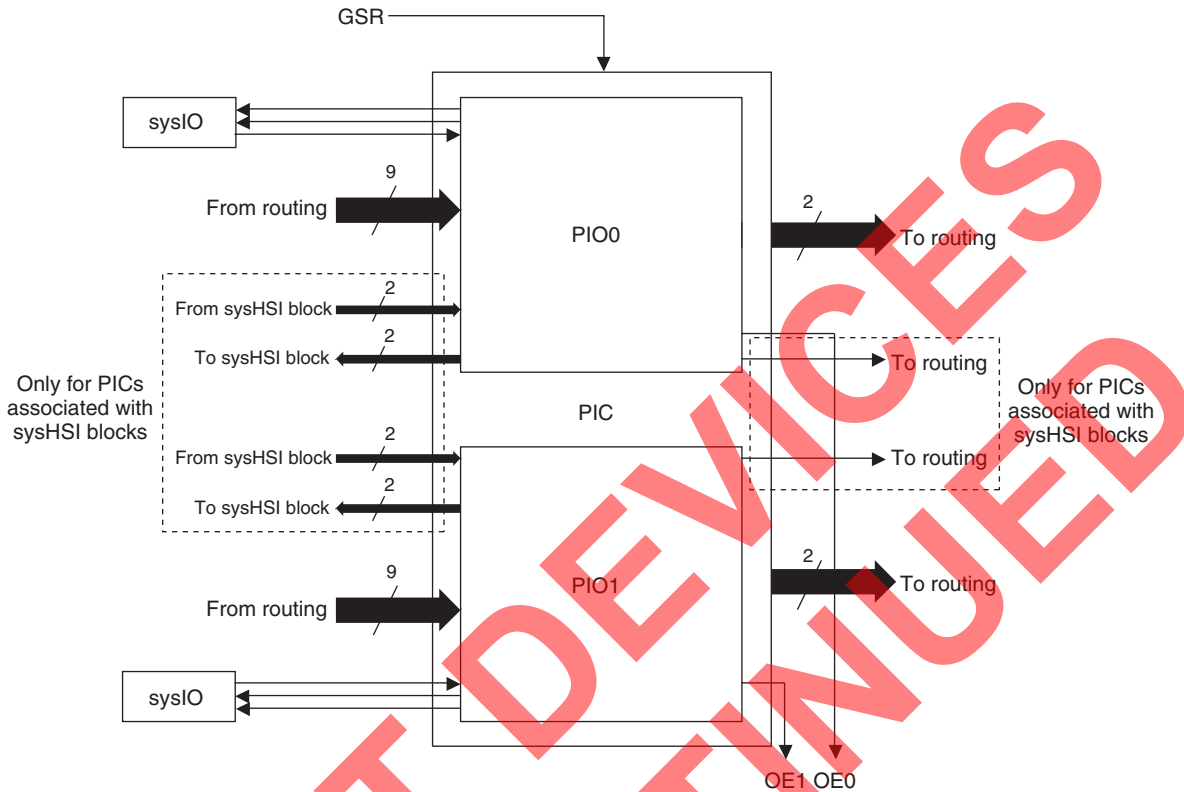


**Programmable Input/Output Cell**

The Programmable Input/Output Cell (PIC) is an essential part of the symmetrical architecture of the ispXPGA Family. The PICs interface the PFUs and EBRs to the sysIO and sysHSI blocks of the device.

Each PIC contains two Programmable Input/Outputs (PIOs) with a total of 21 inputs and 10 outputs. There are 18 inputs from routing, two inputs from the sysIO buffers, and the Global Set/Reset signal. Four outputs of the PIC connect to routing and two outputs are available as Output Enables for the tri-statable Long Lines. The remaining four outputs feed the sysIO buffers directly (one output enable and one output to each). Each PIC associated with a sysHSI block has four additional inputs and six additional outputs to support the sysHSI blocks. The four additional inputs come from the sysHSI block associated with the PIC. The four of the six additional outputs come from the PIC outputs and feed the sysHSI block, while the remaining two outputs feed routing. Figure 10 shows the block diagram of the PIC with the sysHSI block inputs and outputs.

Figure 10. ispXPGA PIC



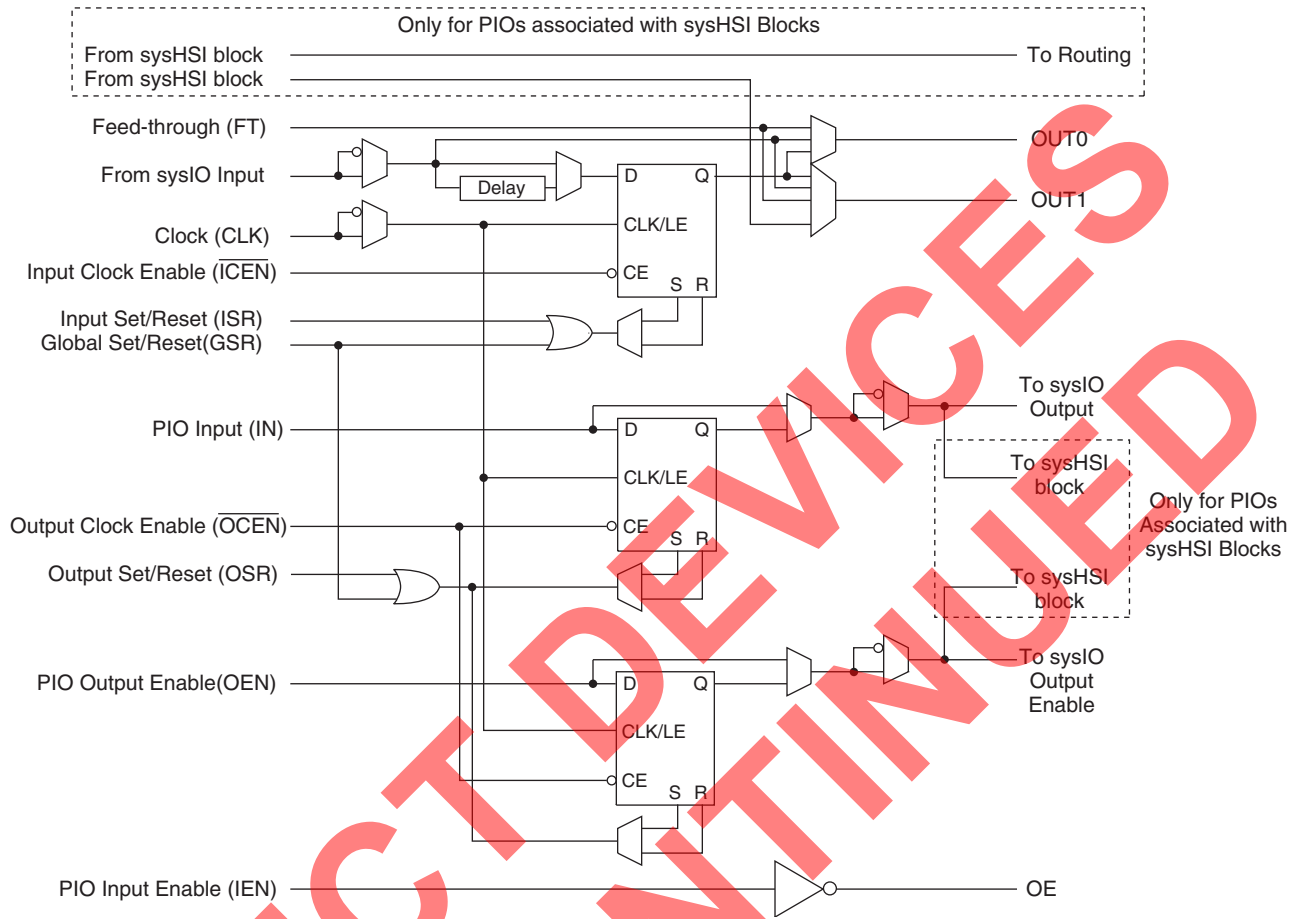
## Programmable Input/Output

The PIO is the building block of a PIC. The PIO has a total of 11 inputs and five outputs. Nine of the 11 inputs are generated from routing. The inputs from routing are the PIO Input (IN), Feed-Thru (FT), Clock (CLK), Input Clock Enable (ICE), Input Set/Reset (ISR), Output Clock Enable (OCEN), Output Set/Reset (OSR), PIO Output Enable (OEN), and PIO Input Enable (IEN). The remaining inputs are the sysIO input buffer signal and the Global Set/Reset signal. Three of the five outputs (OUT0, OUT1, and OE) feed routing. The last two outputs feed the sysIO buffer directly as the output and output enable of the sysIO output buffer.

PIOs associated with sysHSI blocks contain two additional inputs and outputs to support the sysHSI block. The two inputs come from the sysHSI block associated with the PIO, and the two outputs feed the sysHSI block. One of the inputs routes directly through the PIO to routing, while the other is multiplexed with the Feed-Thru, register bypass, and Q output of the register to form the OUT1 output of the PIO. The outputs to the sysHSI block are the same signals as the outputs which feed the sysIO buffers (sysIO Output and sysIO Output Enable).

Each PIO has an input register, an output register, and an output enable register as shown in Figure 11. The input register path of the PIO has a 'delay' option, which slows the data-flow. A two-input OR function of the Global Set/Reset (GSR) and Set/Reset (ISR or OSR) signals creates the set/reset term for the respective registers. Each PIO has two pairs of set/reset and clock enable signals. One is exclusive to the input register, whereas the other is common for both the output and output enable registers. The clock (CLK) is common to all registers in a PIO, and the polarity of the clock is controllable. The input, output, and the output enable registers can be configured as a latch or D-type flip-flop. Each PIO is capable of generating an output enable signal, which in turn becomes a PIC output.

Figure 11. ispXPGA PIO



### VLI Routing Resources

The ispXPGA architecture contains a Variable-Length-Interconnect (VLI) routing technology connecting the PFUs, PICs, and EBRs in the device. There are four types of routing resources, Global Lines, Long Lines, General Interconnect, and Local Lines forming the global routing structure. This allows a signal to be routed to any element in the device with the optimal delay.

The Global Lines consist of global clock lines and a global set/reset line. These lines are routed to all elements in the device. They are specifically designed for high speed, predictable timing regardless of fan-out. The global clock lines can also be used as dedicated inputs.

The Long Lines consist of Horizontal and Vertical Long Lines (HLL and VLL). The VLL and HLL are tri-statable lines spanning the entire device. These lines allow fast routing for high fan-out nets and general-purpose functions.

The General Interconnect consists of Double and Deca Lines. The Double Lines connect up to three elements (two plus the driving element), while the Deca Lines connect up to eleven elements (ten plus the driving element).

The Local Lines are extremely fast routing paths consisting of Feedback and Direct Connect Lines. The Feedback Lines are internal routing paths from the PFU outputs to the PFU inputs. The Direct Connect Lines connect all adjacent elements.

The Common Interface Block (CIB) provides the link between the logic element (PFU, PIC, or EBR) and the VLI Routing resources. The CIB is a switch matrix that can be programmed to connect virtually any routing resource to any input or output of the logic element.

## Memory

The ispXPGA architecture provides a large amount of resources for memory intensive applications. Embedded Block RAMs (EBRs) are available to complement the Distributed Memory that is configured in the PFUs (see Look-Up Table -Distributed Memory Mode in the PFU section above). Each memory element can be configured as RAM or ROM. Additionally, the internal logic of the device can be used to configure the memory elements as FIFO and other storage types. These EBRs are referred to as sysMEM blocks. Refer to Table 1 for memory resources per device.

### sysMEM Blocks

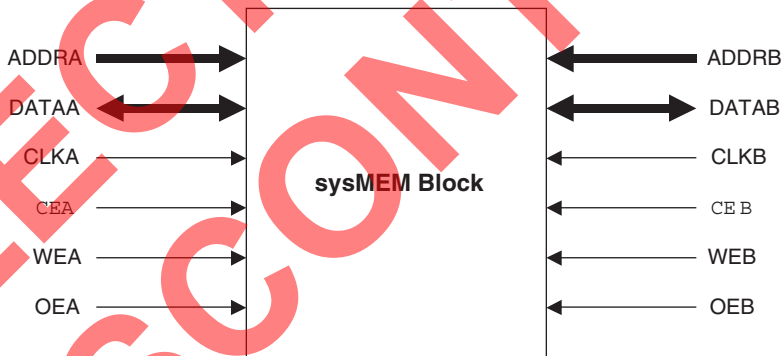
The sysMEM blocks are organized in columns distributed throughout the device. Each EBR contains 4.6K bits of dual-port RAM with dedicated control, address, and data lines for each port. Each column of sysMEM blocks has dedicated address and control lines that can be used by each block separately or cascaded to form larger memory elements. The memory cells are symmetrical and contain two sets of identical control signals. Each port has a read/write clock, clock enable, write enable, and output enable. Figure 12 illustrates the sysMEM block.

The ispXPGA memory block can operate as single-port or dual-port RAM. Supported configurations are:

- 512 x 9 bits single-port (8 bits data / 1 bit parity)
- 256 x 18 bits single-port (16 bits data / 2 bits parity)
- 512 x 9 bits dual-port (8 bits data / 1 bit parity)
- 256 x 18 bits dual-port (16 bits data / 2 bits parity)

The data widths of “9” and “18” are ideal for applications where parity is necessary. This allows 9 data bits, 8 data bits plus a parity bit, 18 data bits, or 16 data bits plus two parity bits. The logic for generating and checking the parity must be customized separately.

**Figure 12. sysMEM Block Diagram**



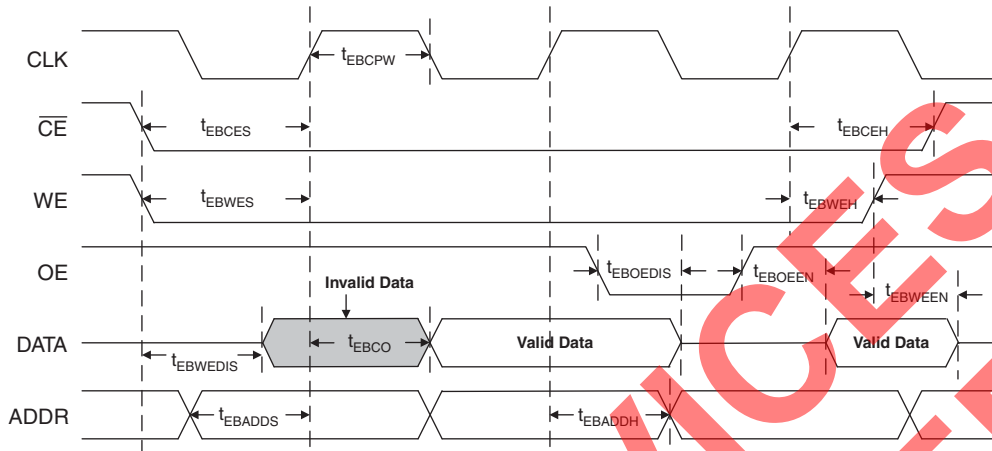
### Read and Write Operations

The ispXPGA EBR has fully synchronous read and write operations as well as an asynchronous read operation. These operations allow several different types of memory to be implemented in the device.

**Synchronous Read:** The Clock Enable ( $\overline{CE}$ ) and Write Enable (WE) signals control the synchronous read operation. When the  $\overline{CE}$  signal is low, the clock is enabled. When the WE signal is low the read operation begins. Once the address (ADDR) is present, a rising clock edge (or falling edge depending on polarity) causes the stored data to be available on the DATA port. Figure 13 illustrates the synchronous read timing.

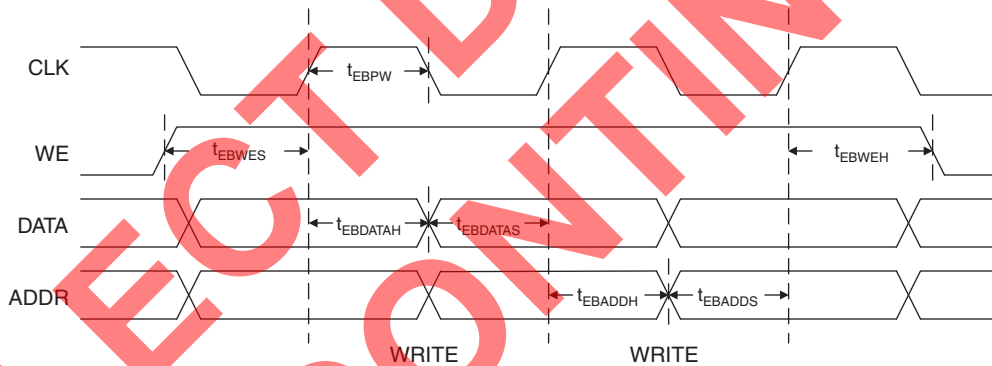


Figure 13. EBR Synchronous Read Timing Diagram



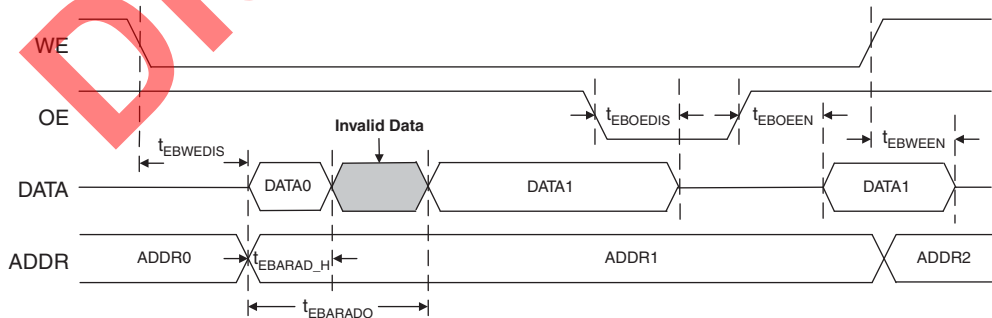
**Synchronous Write:** The WE signal controls the synchronous write operation. When the WE signal is high, the write operation begins. Once the address and data are present and the Output Enable (OE) is active, a rising clock edge (or falling edge depending on polarity) causes the data to be stored into the EBR. Figure 14 illustrates the synchronous write timing.

Figure 14. EBR Synchronous Write Timing Diagram



**Asynchronous Read:** The WE signal controls the asynchronous read operation. When the WE signal is low, the read operation begins. Shortly after the address is present, the stored data is available on the DATA port. Figure 15 illustrates the asynchronous read timing. For more information about the EBR, refer to TN1028 [ispXPGA Memory Usage Guidelines](#).

Figure 15. EBR Asynchronous Read Timing Diagram



### sysCLOCK PLL Description

The sysCLOCK PLL circuitry consists of Phase-Lock Loops (PLLs) and the various dividers, reset, and feedback signals associated with the PLLs. This feature gives the user the ability to synthesize clock frequencies and generate multiple clock signals for routing within the device. Furthermore, it can generate clock signals that are aligned either at the board level or the device level.

The ispXPGA devices provide up to eight PLLs. Each PLL receives its input clock from its associated global clock pin, and its output is routed to the associated global clock net. For example, PLL0 receives its clock input from the GCLK0 global clock pin and provides output to the CLK0 global clock net. The PLL also has the ability to output a secondary clock that is a division of the primary clock output. When using the secondary clock, the secondary clock will be routed to the neighboring global clock net. For example, PLL0 will drive its primary clock output on the CLK0 global clock net and its secondary clock output will drive the CLK1 global clock net. Additionally, each PLL has a set of PLL\_RST, PLL\_FBK, and PLL\_LOCK signals. The PLL\_RST signal can be generated through routing or a dedicated dual-function I/O pin. The PLL\_FBK signal can be generated through a dedicated dual-function I/O pin or internally from the Global Clock net associated with the PLL. The PLL\_LOCK signal feeds routing directly from the sysCLOCK PLL circuit. Figure 17 illustrates how the PLL\_RST and PLL\_FBK signals are generated.

Each PLL has four dividers associated with it, M, N, V, and K. The M divider is used to divide the clock signal, while the N divider is used to multiply the clock signal. The V divider allows the VCO frequency to operate at higher frequencies than the clock output, thereby increasing the frequency range. The K divider is only used when a secondary clock output is needed. This divider divides the primary clock output and feeds to the adjacent global clock net. Different combinations of these dividers allow the user to synthesize clock frequencies. Figure 16 shows the ispXPGA PLL block diagram.

The PLL also has a delay feature that allows the output clock to be advanced or delayed to improve set-up and clock-to-out times for better performance. This operates by inserting delay on the input or feedback lines of the PLL. For more information on the PLL, please refer to TN1003, [sysCLOCK PLL Usage and Design Guidelines](#).

**Figure 16. ispXPGA PLL Block Diagram**

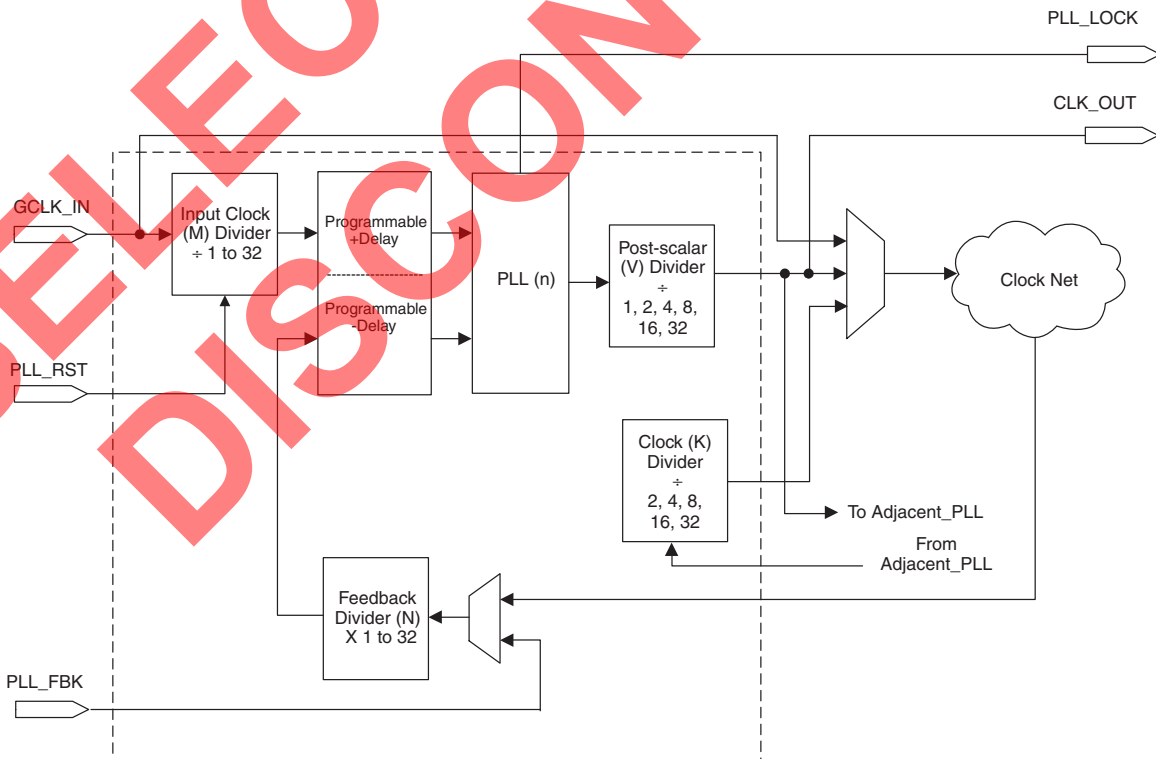
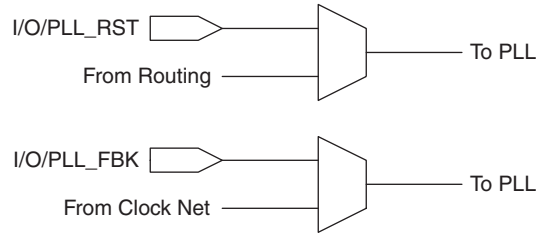


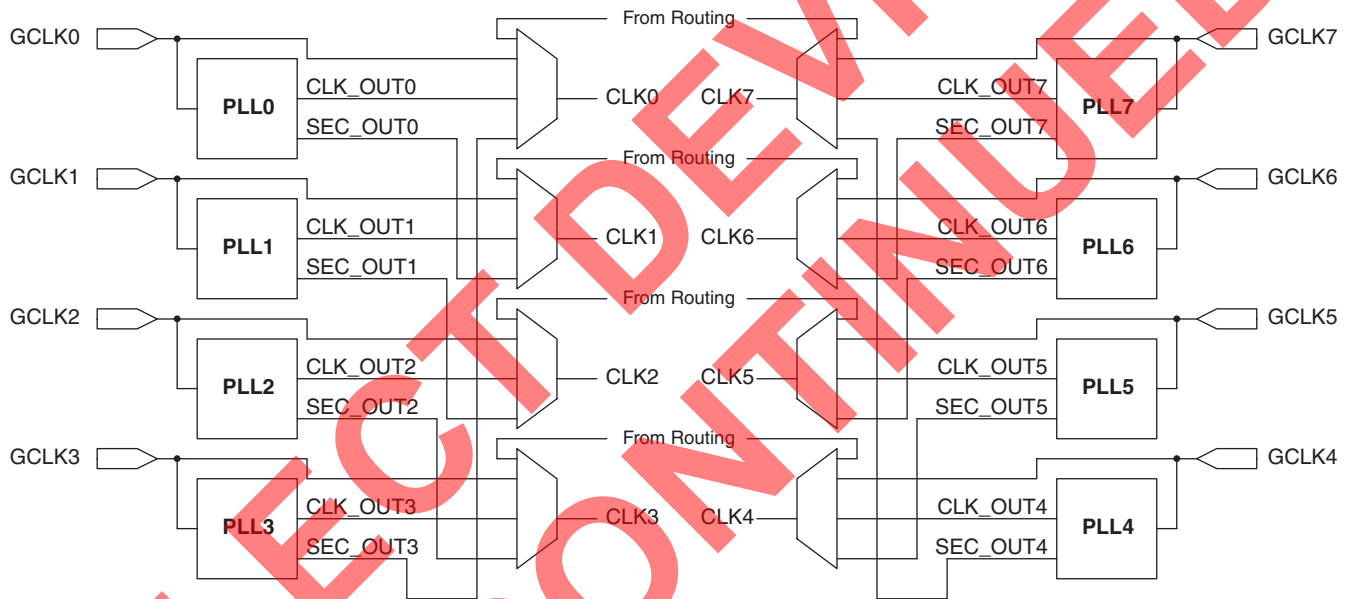
Figure 17. ispXPGA PLL\_RST and PLL\_FBK Generation



### Clock Routing

The Global Clock Lines (GCLK) have two sources, their dedicated pins and the sysCLOCK circuit. Figure 18 illustrates the generation of the Global Clock Lines.

Figure 18. Global Clock Line Generation



### sysIO Capability

All the ispXPGA devices have eight sysIO banks, where each bank is capable of supporting multiple I/O standards. Each sysIO bank has its own I/O supply voltage ( $V_{CCO}$ ) and reference voltage ( $V_{REF}$ ) resources allowing each bank complete independence from the others. Each I/O is individually configurable based on the bank's  $V_{CCO}$  and  $V_{REF}$  settings. In addition, each I/O has configurable drive strength, weak pull-up, weak pull-down, or a bus-keeper latch. Table 4 lists the number of I/Os supported per bank in each of the ispXPGA devices. In addition, 5V tolerant inputs are specified within an I/O bank that is connected to  $V_{CCO}$  of 3.0V to 3.6V for LVCMOS 3.3, LVTTTL and PCI interfaces.

Table 5 lists the sysIO standards with the typical values for  $V_{CCO}$ ,  $V_{REF}$  and  $V_{TT}$ .

The TOE, JTAG TAP pins, PROGRAM, CFG0 and DONE pins of the ispXPGA device are the only pins that do not have the sysIO capabilities. The TOE and CFG0 pins operate off the  $V_{CC}$  of the device, supporting only the LVCMOS standard corresponding to the device supply voltage. The TAP pins have a separate supply voltage ( $V_{CCJ}$ ), which determines the LVCMOS standard corresponding to that supply voltage.

There are three classes of I/O interface standards that are implemented in the ispXPGA devices. The first is the unterminated, single-ended interface. It includes the 3.3V LVTTTL standard along with the 1.8V, 2.5V, and 3.3V LVCMOS interface standards. Additionally, PCI and AGP-1X are subsets of this type of interface.

The second type of interface implemented is the terminated, single-ended interface standard. This group of interfaces includes different versions of SSTL and HSTL interfaces along with CTT, and GTL+. Usage of these particular I/O interfaces requires an additional  $V_{REF}$  signal. At the system level a termination voltage,  $V_{TT}$ , is also required. Typically an output will be terminated to  $V_{TT}$  at the receiving end of the transmission line it is driving.

The third type of interface standards are the differential standards LVDS, BLVDS, and LVPECL. The differential standards require two I/O pins to create the differential pair. The logic level is determined by the difference in the two signals. Table 6 lists how these interface standards are implemented in the ispXPGA devices.

For more information on sysIO capability, refer to TN1000, [sysIO Usage Guidelines for Lattice Devices](#).

Figure 19. sysIO Banks per Device

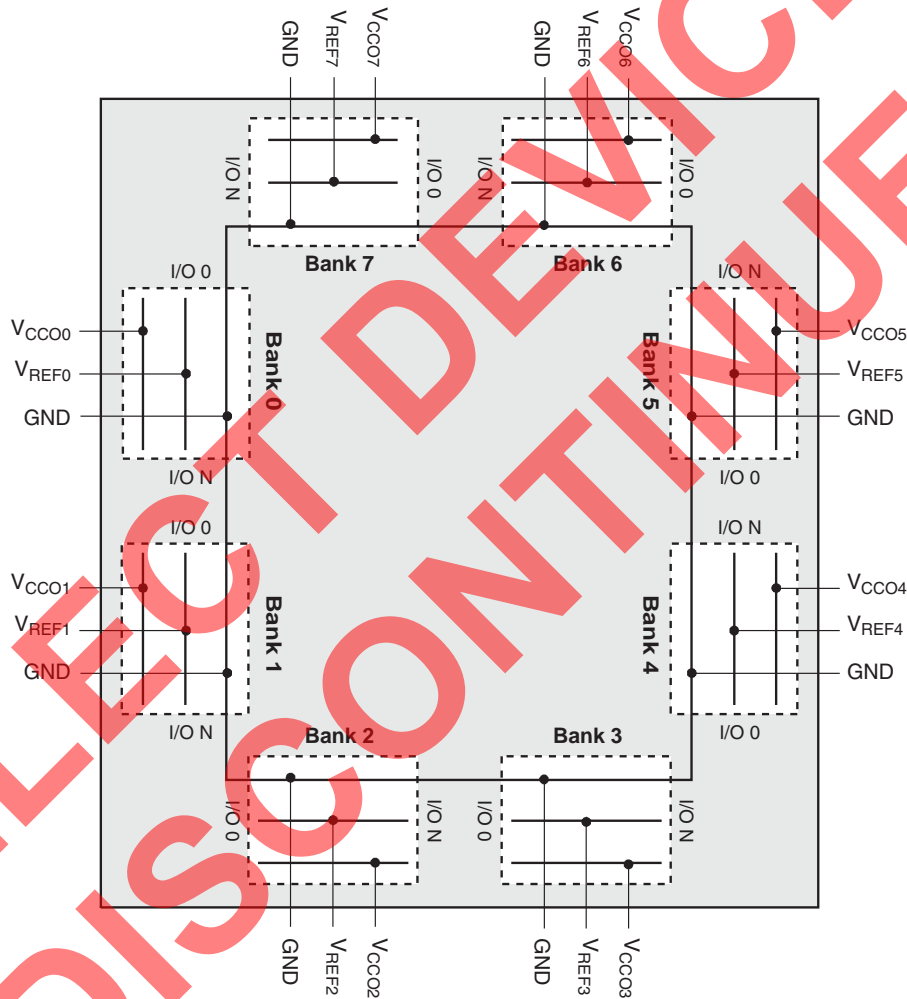


Table 4. Number of I/Os per Bank

| Device    | Max. Number of I/Os per Bank (N) |
|-----------|----------------------------------|
| XPGA 1200 | 62                               |
| XPGA 500  | 42                               |
| XPGA 200  | 26                               |
| XPGA 125  | 22                               |

**Table 5. ispXPGA Supported I/O Standards**

| sysIO Standard     | V <sub>CCO</sub> | V <sub>REF</sub> | V <sub>TT</sub> |
|--------------------|------------------|------------------|-----------------|
| LVTTTL             | 3.3V             | N/A              | N/A             |
| LVC MOS-3.3        | 3.3V             | N/A              | N/A             |
| LVC MOS-2.5        | 2.5V             | N/A              | N/A             |
| LVC MOS-1.8        | 1.8V             | N/A              | N/A             |
| PCI                | 3.3V             | N/A              | N/A             |
| AGP-1X             | 3.3V             | N/A              | N/A             |
| SSTL3, Class I, II | 3.3V             | 1.5V             | 1.5V            |
| SSTL2, Class I, II | 2.5V             | 1.25V            | 1.25V           |
| HSTL, Class I      | 1.5V             | 0.75V            | 0.75V           |
| HSTL, Class III    | 1.5V             | 0.9V             | 1.5V            |
| GTL+               | N/A              | 1.0V             | 1.5V            |
| LVPECL             | 3.3V             | N/A              | N/A             |
| LVDS <sup>1</sup>  | 2.5V             | N/A              | N/A             |
| BLVDS              | 2.5V             | N/A              | N/A             |

1. V<sub>CCO</sub> must be 2.5V for high speed serial operations (sysHSI block).

**Table 6. Differential Interface Standard Support<sup>1</sup>**

|        |          | sysIO Buffer Not Using sysHSI Block      | sysIO Buffer Using sysHSI Block     |
|--------|----------|------------------------------------------|-------------------------------------|
| LVDS   | Driver   | Supported with external resistor network | Supported                           |
|        | Receiver | Supported with standard termination      | Supported with standard termination |
| BLVDS  | Driver   | Supported with external resistor network | Not supported                       |
|        | Receiver | Supported (may need termination)         | Supported (may need termination)    |
| LVPECL | Driver   | Supported with external resistor network | Not supported                       |
|        | Receiver | Supported with termination               | Supported with termination          |

1. For more information, refer to TN1000, [sysIO Usage Guidelines for Lattice Devices](#).

## High Speed Serial Interface Block (sysHSI Block)<sup>1</sup>

The High Speed Serial Interface (sysHSI) allows high speed serial data transfer over a pair of LVDS I/O. The ispXPGA devices have multiple sysHSI blocks.

Each sysHSI block has two SERDES blocks which contain two main sub-blocks, Transmitter (with a serializer) and Receiver (with a deserializer) including Clock/Data Recovery Circuit (CDR). Each SERDES can be used as a full duplex channel. The two SERDES in sysHSI blocks share a common clock and must operate at the same nominal frequency. Figure 20 shows the sysHSI block.

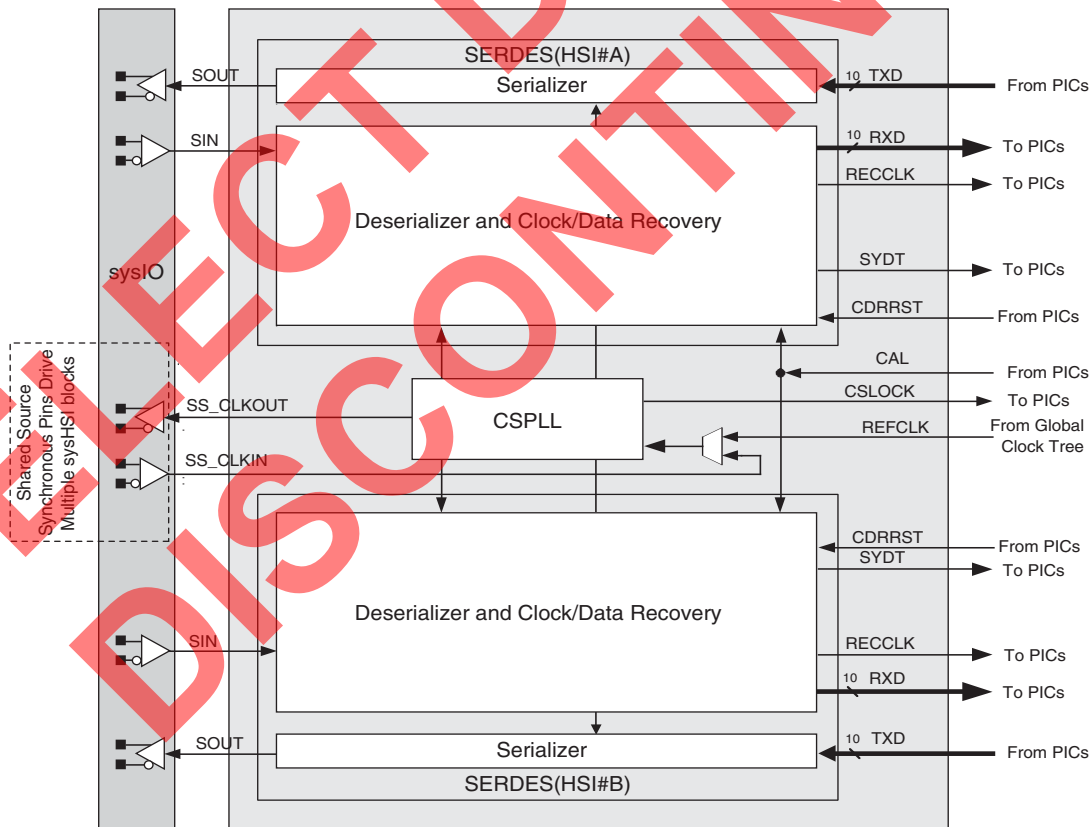
Device features support two data coding modes: 10B/12B and 8B/10B (for use with other encoding schemes, see Lattice’s sysHSI technical notes). The encoding and decoding of the 10B/12B standard are performed within the sysHSI block. For the 8B/10B standard, the symbol boundaries are aligned internally but the encoding and decoding are performed outside the sysHSI block.

Each SERDES block receives a single high speed serial data input stream (with embedded clock) from an input, and provide a low speed 10-bit wide data stream and a recovered clock to the device. For transmitting, SERDES converts a 10-bit wide low-speed data stream to a single high-speed data stream with embedded clock for output.

Additionally, multiple sysHSI blocks can be grouped together to form a source synchronous interface of 1-10 channels.

For more information on the SERDES/CDR, refer to TN1020, [sysHSI Usage Guidelines](#).

**Figure 20. sysHSI Block Diagram**



1. “E-Series” does not support sysHSI.

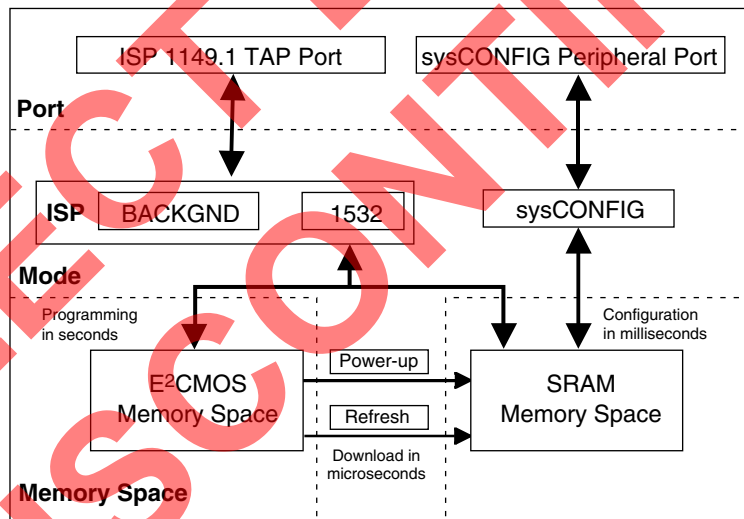
## Configuration and Programming

The ispXPGA family of devices takes a unique approach to FPGA configuration memory. It contains two types of memory, Static RAM and non-volatile E<sup>2</sup>CMOS cells. The static RAM is used to control the functionality of the device during normal operation and the E<sup>2</sup>CMOS memory cells are used to load the SRAM. The E<sup>2</sup>CMOS memory module can be thought of as the hard drive for the ispXPGA configuration and the SRAM as the working configuration memory. There is a one-to-one relationship between SRAM memory and the E<sup>2</sup>CMOS cells. The SRAM can be configured either from the E<sup>2</sup>CMOS memory or from an external source, as shown in Figure 21.

Figure 21 shows the different ports and modes that are used in the configuration and programming of the ispXPGA devices. There are two possible ports that can be used for configuration of the SRAM memory: the ISP port which supports the IEEE 1149.1 Test Access Port (TAP) Std., accommodates bit-wide configuration. The sysCONFIG port allows byte-wide configuration of the SRAM configuration memory. When programming the E<sup>2</sup>CMOS memory, only the 1149.1 TAP can be used.

Configuration and programming done through the 1149.1 Test Access Port (TAP) supports both the IEEE Std. 1149.1 Boundary Scan TAP specification and the IEEE Std. 1532 In-System Configuration specification. To configure or program the device using the 1149.1 TAP the device must be in the ISP mode. To configure the SRAM memory using the sysCONFIG Port, the device must be in the sysCONFIG mode. Upon power-up, the device's SRAM memory can be configured either from the E<sup>2</sup>CMOS memory or from an external source through the sysCONFIG mode. Additionally, the SRAM can be re-configured from the E<sup>2</sup>CMOS memory by executing a "REFRESH." See TN1026, [ispXP Configuration Usage Guidelines](#), for more in depth information on the different programming modes, timing and wake-up.

**Figure 21. ispXP Block Diagram**



## Supports IEEE 1149.1 Boundary Scan Testability

All ispXPGA devices have boundary scan cells and supports the IEEE 1149.1 standard. This allows functional testing of the circuit board on which the device is mounted through a serial scan path that can access all critical logic nodes. Internal boundary scan registers are linked internally, allowing test data to be shifted in and loaded directly onto test nodes, or test node data to be captured and shifted out for verification. In addition, these devices can be linked into a board-level serial scan path for more board level testing.

## Security Scheme

A programmable security scheme is provided on the ispXPGA devices as a deterrent to unauthorized copying of the array configuration patterns. Once programmed, the security scheme prevents read-back of the programmed

pattern by a device programmer, securing proprietary designs from competitors. The entire device must be erased in order to erase the security scheme.

### Density Shifting

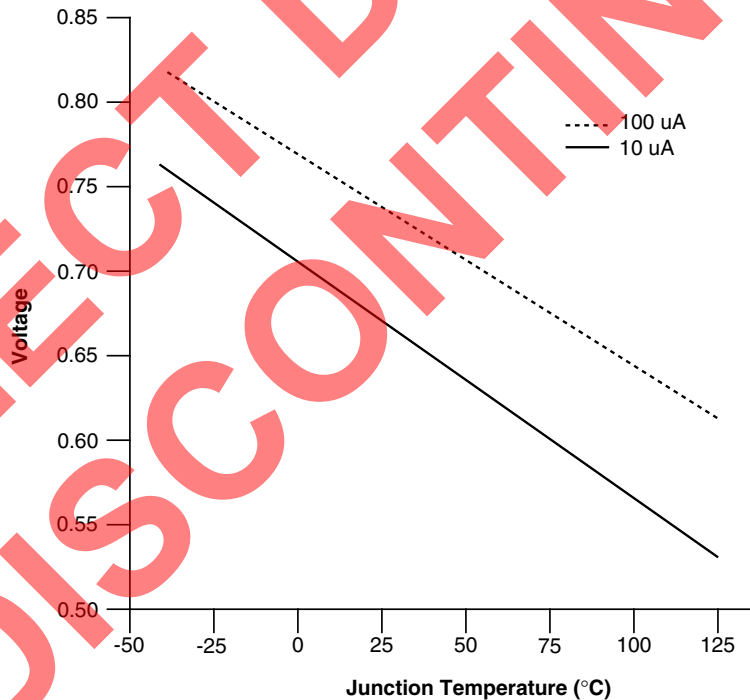
The ispXPGA family has been designed to ensure that different density devices in the same package have the same pin-out. Furthermore, the architecture ensures a high success rate when performing design migration from lower density parts to higher density parts. In many cases, it is possible to shift a lower utilization design targeted for a high-density device to a lower density device. However, the exact details of the final resource utilization will impact the likely success in each case.

### Temperature Sensing Diode

The built-in temperature-sensing diodes allow junction temperature to be measured during device operation. A pair of pins (DXp and DXn) are dedicated for monitoring device junction temperature. The measurement is done by forcing 10  $\mu$ A and 100  $\mu$ A current in the forward direction, and then measuring the resulting voltage. The voltage decreases with increasing temperature at approximately 1.64 mV/ $^{\circ}$ C. A typical device with a 85 $^{\circ}$ C junction temperature will measure approximately 593 mV.

The temperature-sensing diode works for the entire operating range as shown in Figure 22 - Sensing Diode Voltage-Temperature Relationship. Refer to the Lattice [Thermal Management](#) document for thermal coefficients. Also refer to TN1043, [Power Estimation in ispXPGA Devices](#).

**Figure 22. Sensing Diode Voltage-Temperature Relationship**





### Absolute Maximum Ratings<sup>1, 2, 3</sup>

|                                                           | 1.8V         | 2.5V/3.3V    |
|-----------------------------------------------------------|--------------|--------------|
| Supply Voltage (V <sub>CC</sub> )                         | -0.5 to 2.5V | -0.5 to 5.5V |
| PLL Supply Voltage (V <sub>CCP</sub> )                    | -0.5 to 2.5V | -0.5 to 5.5V |
| Output Supply Voltage (V <sub>CCO</sub> )                 | -0.5 to 4.5V | -0.5 to 4.5V |
| IEEE 1149.1 TAP Supply Voltage (V <sub>CCJ</sub> )        | -0.5 to 4.5V | -0.5 to 4.5V |
| Input Voltage Applied <sup>4, 5</sup>                     | -0.5 to 5.5V | -0.5 to 5.5V |
| Storage Temperature                                       | -65 to 150°C | -65 to 150°C |
| Junction Temperature (T <sub>J</sub> ) with Power Applied | -55 to 150°C | -55 to 150°C |

1. Stress above those listed under the “Absolute Maximum Ratings” may cause permanent damage to the device. Functional operation of the device at these or any other conditions above those indicated in the operational sections of this specification is not implied (while programming, following the programming specifications).
2. Compliance with the Lattice [Thermal Management](#) document is required.
3. All voltages referenced to GND.
4. Overshoot and undershoot of -2V to (V<sub>IH</sub> (MAX) + 2) volts not to exceed 6V is permitted for a duration of <20ns.
5. A maximum of 64 I/Os per device with V<sub>IN</sub> > 3.6V is allowed.

### Recommended Operating Conditions

| Symbol               | Parameter                                                           | Min  | Max  | Units |
|----------------------|---------------------------------------------------------------------|------|------|-------|
| V <sub>CC</sub>      | Supply Voltage for 1.8V device <sup>1</sup>                         | 1.65 | 1.95 | V     |
|                      | Supply Voltage for 2.5V device                                      | 2.3  | 2.7  | V     |
|                      | Supply Voltage for 3.3V device                                      | 3.0  | 3.6  | V     |
| V <sub>CCP</sub>     | Supply Voltage for PLL and sysHSI blocks, 1.8V devices <sup>1</sup> | 1.65 | 1.95 | V     |
|                      | Supply Voltage for PLL and sysHSI blocks, 2.5V devices              | 2.3  | 2.7  | V     |
|                      | Supply Voltage for PLL and sysHSI blocks, 3.3V devices              | 3.0  | 3.6  | V     |
| V <sub>CCJ</sub>     | Supply Voltage for IEEE 1149.1 Test Access Port for LVCMOS 1.8V     | 1.65 | 1.95 | V     |
|                      | Supply Voltage for IEEE 1149.1 Test Access Port for LVCMOS 2.5V     | 2.3  | 2.7  | V     |
|                      | Supply Voltage for IEEE 1149.1 Test Access Port for LVCMOS 3.3V     | 3.0  | 3.6  | V     |
| T <sub>J</sub> (COM) | Junction Temperature Commercial Operation                           | 0    | 85   | C     |
| T <sub>J</sub> (IND) | Junction Temperature Industrial Operation                           | -40  | 105  | C     |

1. sysHSI specification is valid for V<sub>CC</sub> and V<sub>CCP</sub> = 1.7V to 1.9V.

### E<sup>2</sup>CMOS Erase Reprogram Specifications

| Parameter                          | Min   | Max | Units  |
|------------------------------------|-------|-----|--------|
| Erase/Reprogram Cycle <sup>1</sup> | 1,000 | —   | Cycles |

1. Valid over commercial temperature range.

### Hot Socketing Characteristics<sup>1, 2, 3, 4</sup>

| Symbol          | Parameter                              | Condition                  | Min | Typ   | Max    | Units |
|-----------------|----------------------------------------|----------------------------|-----|-------|--------|-------|
| I <sub>DK</sub> | Input or Tristated I/O Leakage Current | 0 ≤ V <sub>IN</sub> ≤ 3.0V | —   | +/-50 | +/-800 | μA    |

1. Insensitive to sequence of V<sub>CC</sub> and V<sub>CCO</sub> when V<sub>CCO</sub> ≥ 1.0V. For V<sub>CCO</sub> > 1.0V, V<sub>CC</sub> min must be present. However, assumes monotonic rise/fall rates for V<sub>CC</sub> and V<sub>CCO</sub>, provided (V<sub>IN</sub> - V<sub>CCO</sub>) ≥ 3.6V.
2. LVTTTL, LVCMOS only.
3. 0 < V<sub>CC</sub> ≤ V<sub>CC</sub> (MAX), 0 < V<sub>CCO</sub> ≤ V<sub>CCO</sub> (MAX).
4. I<sub>DK</sub> is additive to I<sub>PU</sub>, I<sub>PD</sub> or I<sub>BH</sub>. Device defaults to pull-up until non-volatile cells are active.

## DC Electrical Characteristics

### Over Recommended Operating Conditions

| Symbol                                         | Parameter                             | Condition                                                            | Min                     | Typ | Max                     | Units |
|------------------------------------------------|---------------------------------------|----------------------------------------------------------------------|-------------------------|-----|-------------------------|-------|
| I <sub>IL</sub> , I <sub>IH</sub> <sup>1</sup> | Input or I/O Low Leakage              | 0 ≤ V <sub>IN</sub> < (V <sub>CCO</sub> - 0.2V)                      | —                       | —   | 10                      | μA    |
|                                                |                                       | (V <sub>CCO</sub> - 0.2V) ≤ V <sub>IN</sub> ≤ 3.6V                   | —                       | —   | 300                     | μA    |
| I <sub>IH</sub> <sup>2</sup>                   | Input High Leakage Current            | 3.6V < V <sub>IN</sub> ≤ 5.5V and<br>3.0V ≤ V <sub>CCO</sub> ≤ 3.6V  | —                       | —   | 3                       | mA    |
| I <sub>PU</sub>                                | I/O Active Pull-up Current            | 0 ≤ V <sub>IN</sub> ≤ 0.7 V <sub>CCO</sub>                           | -30                     | —   | -150                    | μA    |
| I <sub>PD</sub>                                | I/O Active Pull-down Current          | V <sub>IL</sub> (MAX) ≤ V <sub>IN</sub> ≤ V <sub>IH</sub> (MAX)      | 30                      | —   | 150                     | μA    |
| I <sub>BHLS</sub>                              | Bus Hold Low Sustaining Current       | V <sub>IN</sub> = V <sub>IL</sub> (MAX)                              | 30                      | —   | —                       | μA    |
| I <sub>BHHS</sub>                              | Bus Hold High Sustaining Current      | V <sub>IN</sub> = 0.7 V <sub>CCO</sub>                               | -30                     | —   | —                       | μA    |
| I <sub>BHLO</sub>                              | Bus Hold Low Overdrive Current        | 0 ≤ V <sub>IN</sub> ≤ V <sub>IH</sub> (MAX)                          | —                       | —   | 150                     | μA    |
| I <sub>BHHO</sub>                              | Bus Hold High Overdrive Current       | 0 ≤ V <sub>IN</sub> ≤ V <sub>IH</sub> (MAX)                          | —                       | —   | -150                    | μA    |
| V <sub>BHT</sub>                               | Bus Hold Trip Points                  |                                                                      | V <sub>CCO</sub> * 0.35 | —   | V <sub>CCO</sub> * 0.65 | V     |
| C <sub>1</sub>                                 | I/O Capacitance <sup>3</sup>          | V <sub>CCO</sub> = 3.3V, 2.5V, 1.8V                                  | —                       | 8   | —                       | pf    |
|                                                |                                       | V <sub>CC</sub> = 1.8V, V <sub>IO</sub> = 0 to V <sub>IH</sub> (MAX) | —                       | —   | —                       |       |
| C <sub>2</sub>                                 | Clock Capacitance <sup>3</sup>        | V <sub>CCO</sub> = 3.3V, 2.5V, 1.8V                                  | —                       | 8   | —                       | pf    |
|                                                |                                       | V <sub>CC</sub> = 1.8V, V <sub>IO</sub> = 0 to V <sub>IH</sub> (MAX) | —                       | —   | —                       |       |
| C <sub>3</sub>                                 | Global Input Capacitance <sup>3</sup> | V <sub>CCO</sub> = 3.3V, 2.5V, 1.8V                                  | —                       | 6   | —                       | pf    |
|                                                |                                       | V <sub>CC</sub> = 1.8V, V <sub>IO</sub> = 0 to V <sub>IH</sub> (MAX) | —                       | —   | —                       |       |

1. Input or I/O leakage current is measured with the pin configured as an input or as an I/O with the output driver tri-stated. It is not measured with the output driver active. Bus maintenance circuits are disabled.
2. 5V tolerant inputs and I/Os should be placed in banks where 3.0V ≤ V<sub>CCO</sub> ≤ 3.6V. The JTAG and sysCONFIG ports are not included for the 5V tolerant interface.
3. T<sub>A</sub> = 25°C, f = 1.0MHz.

SELECTED PARTS  
 DISCONTINUED

## Supply Current

### Over Recommended Operating Conditions

| Symbol                         | Parameter                                    | Device  | Condition               | Min. | Typ. | Max. | Units |
|--------------------------------|----------------------------------------------|---------|-------------------------|------|------|------|-------|
| I <sub>CC</sub> <sup>1,2</sup> | Standby Core Operating Power Supply Current  | LFX125  | V <sub>CC</sub> = 3.3V  | —    | 60   | —    | mA    |
|                                |                                              |         | V <sub>CC</sub> = 2.5V  | —    | 60   | —    | mA    |
|                                |                                              |         | V <sub>CC</sub> = 1.8V  | —    | 40   | —    | mA    |
|                                |                                              | LFX200  | V <sub>CC</sub> = 3.3V  | —    | 70   | —    | mA    |
|                                |                                              |         | V <sub>CC</sub> = 2.5V  | —    | 70   | —    | mA    |
|                                |                                              |         | V <sub>CC</sub> = 1.8V  | —    | 50   | —    | mA    |
|                                |                                              | LFX500  | V <sub>CC</sub> = 3.3V  | —    | 120  | —    | mA    |
|                                |                                              |         | V <sub>CC</sub> = 2.5V  | —    | 120  | —    | mA    |
|                                |                                              |         | V <sub>CC</sub> = 1.8V  | —    | 100  | —    | mA    |
|                                |                                              | LFX1200 | V <sub>CC</sub> = 3.3V  | —    | 220  | —    | mA    |
|                                |                                              |         | V <sub>CC</sub> = 2.5V  | —    | 220  | —    | mA    |
|                                |                                              |         | V <sub>CC</sub> = 1.8V  | —    | 200  | —    | mA    |
| I <sub>CCO</sub> <sup>3</sup>  | Standby Output Power Supply Current          |         | V <sub>CCO</sub> = 3.3V | —    | 2.0  | —    | mA    |
|                                |                                              |         | V <sub>CCO</sub> = 2.5V | —    | 2.0  | —    | mA    |
|                                |                                              |         | V <sub>CCO</sub> = 1.8V | —    | 2.0  | —    | mA    |
|                                |                                              |         | V <sub>CCO</sub> = 1.5V | —    | 2.0  | —    | mA    |
| I <sub>CCP</sub> <sup>4</sup>  | Standby PLL Operating Supply Current         |         | V <sub>CCP</sub> = 3.3V | —    | 17.0 | —    | mA    |
|                                |                                              |         | V <sub>CCP</sub> = 2.5V | —    | 17.0 | —    | mA    |
|                                |                                              |         | V <sub>CCP</sub> = 1.8V | —    | 15.0 | —    | mA    |
| I <sub>CCJ</sub> <sup>5</sup>  | Standby IEEE 1149.1 TAP Power Supply Current |         | V <sub>CCJ</sub> = 3.3V | —    | 2.0  | —    | mA    |
|                                |                                              |         | V <sub>CCJ</sub> = 2.5V | —    | 1.5  | —    | mA    |
|                                |                                              |         | V <sub>CCJ</sub> = 1.8V | —    | 1.0  | —    | mA    |

1. T<sub>A</sub> = 25°C, frequency = 1.0 MHz, device configured with 16-bit counters.
2. I<sub>CC</sub> varies with specific device configuration and operating frequency. For more accurate power calculation, see TN1043, [Power Estimation in ispXPGA Devices](#).
3. T<sub>A</sub> = 25°C, per bank, no DC load, frequency = 0 MHz.
4. T<sub>A</sub> = 25°C, per PLL, frequency = 10 MHz.
5. T<sub>A</sub> = 25°C

**sysIO Recommended Operating Conditions**

| Standard                 | V <sub>CCO</sub> (V) <sup>1</sup> |      |      | V <sub>REF</sub> (V) |      |       |
|--------------------------|-----------------------------------|------|------|----------------------|------|-------|
|                          | Min.                              | Typ. | Max. | Min.                 | Typ. | Max.  |
| LVC MOS 3.3              | 3.0                               | 3.3  | 3.6  | -                    | -    | -     |
| LVC MOS 2.5              | 2.3                               | 2.5  | 2.7  | -                    | -    | -     |
| LVC MOS 1.8 <sup>2</sup> | 1.65                              | 1.8  | 1.95 | -                    | -    | -     |
| LV TTL                   | 3.0                               | 3.3  | 3.6  | -                    | -    | -     |
| PCI 3.3                  | 3.0                               | 3.3  | 3.6  | -                    | -    | -     |
| AGP-1X                   | 3.15                              | 3.3  | 3.45 | -                    | -    | -     |
| SSTL 2                   | 2.3                               | 2.5  | 2.7  | 1.15                 | 1.25 | 1.35  |
| SSTL 3                   | 3.0                               | 3.3  | 3.6  | 1.3                  | 1.5  | 1.7   |
| CTT 3.3                  | 3.0                               | 3.3  | 3.6  | 1.35                 | 1.5  | 1.65  |
| CTT 2.5                  | 2.3                               | 2.5  | 2.7  | 1.35                 | 1.5  | 1.65  |
| HSTL Class I             | 1.4                               | 1.5  | 1.6  | 0.68                 | 0.75 | 0.9   |
| HSTL Class III           | 1.4                               | 1.5  | 1.6  | -                    | 0.9  | -     |
| GTL+                     | -                                 | -    | -    | 0.882                | 1.0  | 1.122 |
| LVDS                     | 2.3                               | 2.5  | 2.7  | -                    | -    | -     |
| LVPECL                   | 3.0                               | 3.3  | 3.6  | -                    | -    | -     |
| BLVDS                    | 2.3                               | 2.5  | 2.7  | -                    | -    | -     |

1. Inputs independent of V<sub>CCO</sub>.
2. Design tool default setting.

### sysIO DC Electrical Characteristics

Over Recommended Operating Conditions

| Standard                | V <sub>IL</sub> |                         | V <sub>IH</sub>         |          | V <sub>OL</sub><br>Max. (V) | V <sub>OH</sub><br>Min. (V) | I <sub>OL</sub> (mA)         | I <sub>OH</sub> (mA)             |
|-------------------------|-----------------|-------------------------|-------------------------|----------|-----------------------------|-----------------------------|------------------------------|----------------------------------|
|                         | Min. (V)        | Max. (V)                | Min. (V)                | Max. (V) |                             |                             |                              |                                  |
| LVCMOS 3.3              | -0.3            | 0.8                     | 2.0                     | 5.5      | 0.4                         | V <sub>CCO</sub> - 0.4      | 20, 16, 12, 8, 5.33, 4       | -20, -16, -12, -8, -5.33, -4     |
|                         |                 |                         |                         |          | 0.2                         | V <sub>CCO</sub> - 0.2      | 0.1                          | -0.1                             |
| LVCMOS 2.5              | -0.3            | 0.7                     | 1.7                     | 3.6      | 0.4                         | V <sub>CCO</sub> - 0.4      | 16, 12, 8, 5.33, 4           | -16, -12, -8, -5.33, -4          |
|                         |                 |                         |                         |          | 0.2                         | V <sub>CCO</sub> - 0.2      | 0.1                          | -0.1                             |
| LVCMOS 1.8 <sup>1</sup> | -0.3            | 0.68 <sup>3</sup>       | 1.07 <sup>3</sup>       | 3.6      | 0.4                         | V <sub>CCO</sub> - 0.4      | 12, 8 <sup>1</sup> , 5.33, 4 | -12, -8 <sup>1</sup> , -5.33, -4 |
|                         |                 | 0.35V <sub>CC</sub>     | 0.65V <sub>CC</sub>     |          | 0.2                         | V <sub>CCO</sub> - 0.2      | 0.1                          | -0.1                             |
| LVTTTL                  | -0.3            | 0.8                     | 2.0                     | 5.5      | 0.4                         | V <sub>CCO</sub> - 0.4      | 4                            | -4                               |
|                         |                 |                         |                         |          | 0.2                         | V <sub>CCO</sub> - 0.2      | 0.1                          | -0.1                             |
| PCI 3.3                 | -0.3            | 1.08 <sup>3</sup>       | 1.5 <sup>3</sup>        | 5.5      | 0.1 V <sub>CCO</sub>        | 0.9 V <sub>CCO</sub>        | 1.5                          | -0.5                             |
|                         |                 | 0.3V <sub>CCO</sub>     | 0.5 V <sub>CCO</sub>    |          |                             |                             |                              |                                  |
| AGP-1X                  | -0.3            | 1.08 <sup>3</sup>       | 1.5 <sup>3</sup>        | 3.6      | 0.1 V <sub>CCO</sub>        | 0.9 V <sub>CCO</sub>        | 1.5                          | -0.5                             |
|                         |                 | 0.3 V <sub>CCO</sub>    | 0.5 V <sub>CCO</sub>    |          |                             |                             |                              |                                  |
| SSTL 3 Class I          | -0.3            | V <sub>REF</sub> - 0.2  | V <sub>REF</sub> + 0.2  | 3.6      | 0.7                         | V <sub>CCO</sub> - 1.1      | 8                            | -8                               |
| SSTL 3 Class II         | -0.3            | V <sub>REF</sub> - 0.2  | V <sub>REF</sub> + 0.2  | 3.6      | 0.5                         | V <sub>CCO</sub> - 0.9      | 16                           | -16                              |
| SSTL 2 Class I          | -0.3            | V <sub>REF</sub> - 0.18 | V <sub>REF</sub> + 0.18 | 3.6      | 0.54                        | V <sub>CCO</sub> - 0.62     | 7.6                          | -7.6                             |
| SSTL 2 Class II         | -0.3            | V <sub>REF</sub> - 0.18 | V <sub>REF</sub> + 0.18 | 3.6      | 0.35                        | V <sub>CCO</sub> - 0.43     | 15.2                         | -15.2                            |
| CTT 3.3                 | -0.3            | V <sub>REF</sub> - 0.2  | V <sub>REF</sub> + 0.2  | 3.6      | V <sub>REF</sub> - 0.4      | V <sub>REF</sub> + 0.4      | 8                            | -8                               |
| CTT 2.5                 | -0.3            | V <sub>REF</sub> - 0.2  | V <sub>REF</sub> + 0.2  | 3.6      | V <sub>REF</sub> - 0.4      | V <sub>REF</sub> + 0.4      | 8                            | -8                               |
| HSTL Class I            | -0.3            | V <sub>REF</sub> - 0.1  | V <sub>REF</sub> + 0.1  | 3.6      | 0.4                         | V <sub>CCO</sub> - 0.4      | 8                            | -8                               |
| HSTL Class III          | -0.3            | V <sub>REF</sub> - 0.1  | V <sub>REF</sub> + 0.1  | 3.6      | 0.4                         | V <sub>CCO</sub> - 0.4      | 24                           | -8                               |
| GTL+                    | -0.3            | V <sub>REF</sub> - 0.2  | V <sub>REF</sub> + 0.2  | 3.6      | 0.6                         | N/A                         | 36                           | N/A                              |

1. Design tool default setting.
2. The average DC current drawn by I/Os between adjacent bank GND connections, or between the last GND in an I/O bank and the end of the I/O bank, as shown in the logic signals connection table, shall not exceed n\*8mA. Where n is the number of I/Os between bank GND connections or between the last GND in a bank and the end of a bank
3. Applicable for ispXPGA B devices.

**sysIO Differential Standards DC Electrical Characteristics<sup>1</sup>**

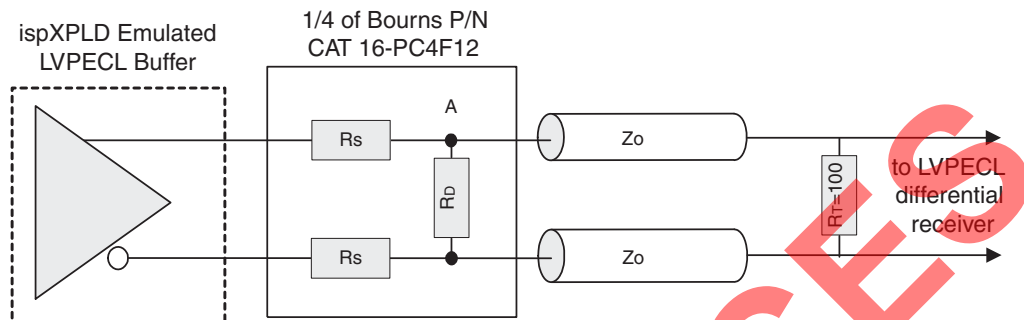
| Parameter                           | Description                                                | Test Conditions                                                 | Min.     | Typ.  | Max.    |
|-------------------------------------|------------------------------------------------------------|-----------------------------------------------------------------|----------|-------|---------|
| <b>LVDS<sup>2</sup></b>             |                                                            |                                                                 |          |       |         |
| V <sub>INP</sub> , V <sub>INM</sub> | Input voltage                                              |                                                                 | 0V       | —     | 2.4V    |
| V <sub>THD</sub>                    | Differential input threshold                               | 0.2V δ V <sub>CM</sub> δ 1.8V                                   | +/-100mV | —     | —       |
| I <sub>IN</sub>                     | Input current                                              | Power on                                                        | —        | —     | +/-10uA |
| V <sub>OH</sub>                     | Output High Voltage for V <sub>OP</sub> or V <sub>OM</sub> | R <sub>T</sub> = 100 Ohm                                        | —        | 1.38V | 1.60V   |
| V <sub>OL</sub>                     | Output Low Voltage for V <sub>OP</sub> or V <sub>OM</sub>  | R <sub>T</sub> = 100 Ohm                                        | 0.9V     | 1.03V | —       |
| V <sub>OD</sub>                     | Output Voltage Differential                                | V <sub>OP</sub> - V <sub>OM</sub>  , R <sub>T</sub> = 100 ohm   | 250mV    | 350mV | 450mV   |
| ΔV <sub>OD</sub>                    | Change in V <sub>OD</sub> between high and low             |                                                                 | —        | —     | 50mV    |
| V <sub>OS</sub>                     | Output Voltage Offset                                      | V <sub>OP</sub> + V <sub>OM</sub>  /2, R <sub>T</sub> = 100 ohm | 1.125V   | 1.25V | 1.375V  |
| ΔV <sub>OS</sub>                    | Change in V <sub>OS</sub> between H and L                  |                                                                 | —        | —     | 50mV    |
| I <sub>OSD</sub>                    | Output short circuit current                               | V <sub>OD</sub> = 0V Driver outputs shorted                     | —        | —     | 24mA    |
| <b>BLVDS<sup>1</sup></b>            |                                                            |                                                                 |          |       |         |
| V <sub>INP</sub> , V <sub>INM</sub> | Input voltage                                              |                                                                 | 0V       | —     | 2.4V    |
| V <sub>THD</sub>                    | Differential input threshold                               | 0.2V δ V <sub>CM</sub> δ 1.8V                                   | +/-100mV | —     | —       |
| I <sub>IN</sub>                     | Input current                                              | Power on                                                        | —        | —     | +/-10uA |
| V <sub>OH</sub>                     | Output High Voltage for V <sub>OP</sub> or V <sub>OM</sub> | R <sub>T</sub> = 27Ω                                            | —        | 1.4V  | 1.80V   |
| V <sub>OL</sub>                     | Output Low Voltage for V <sub>OP</sub> or V <sub>OM</sub>  | R <sub>T</sub> = 27Ω                                            | 0.95V    | 1.1V  | —       |
| V <sub>OD</sub>                     | Output Voltage Differential                                | V <sub>OP</sub> - V <sub>OM</sub>  , R <sub>T</sub> = 27Ω       | 240mV    | 300mV | 460mV   |
| ΔV <sub>OD</sub>                    | Change in V <sub>OD</sub> Between H and L                  |                                                                 |          |       | 27mV    |
| V <sub>OS</sub>                     | Output Voltage Offset                                      | V <sub>OP</sub> + V <sub>OM</sub>  /2, R <sub>T</sub> = 27Ω     | 1.1V     | 1.3V  | 1.5V    |
| ΔV <sub>OS</sub>                    | Change in V <sub>OS</sub> Between H and L                  |                                                                 |          |       | 27mV    |
| I <sub>OSD</sub>                    | Output Short Circuit Current                               | V <sub>OD</sub> = 0. Driver Outputs Shorted.                    |          | 36mA  | 65mA    |

1. Refer to TN1000, [sysIO Usage Guidelines for Lattice Devices](#).  
 2. V<sub>OP</sub> and V<sub>OM</sub> are the two outputs of the LVDS/BLVDS output buffer.

| <b>LVPECL<sup>1</sup></b>      |                              |      |       |      |       |      |       |       |
|--------------------------------|------------------------------|------|-------|------|-------|------|-------|-------|
| DC Parameter                   | Parameter Description        | Min. | Max.  | Min. | Max.  | Min. | Max.  | Units |
| V <sub>CCO</sub>               |                              | 3.0  |       | 3.3  |       | 3.6  |       | V     |
| V <sub>IH</sub>                | Input Voltage High           | 1.49 | 2.72  | 1.49 | 2.72  | 1.49 | 2.72  | V     |
| V <sub>IL</sub>                | Input Voltage Low            | 0.86 | 2.125 | 0.86 | 2.125 | 0.86 | 2.125 | V     |
| V <sub>OH</sub>                | Output Voltage High          | 1.8  | 2.11  | 1.92 | 2.28  | 2.13 | 2.41  | V     |
| V <sub>OL</sub>                | Output Voltage Low           | 0.96 | 1.27  | 1.06 | 1.43  | 1.3  | 1.57  | V     |
| V <sub>DIFF</sub> <sup>2</sup> | Differential Input threshold | 0.3  | —     | 0.3  | —     | 0.3  | —     | V     |

1. These values are valid at the output of the source termination pack as shown above with 100-ohm differential load only (see Figure 23). The V<sub>OH</sub> levels are 200mV below the standard LVPECL levels and are compatible with devices tolerant of the lower common mode ranges.  
 2. Valid for 0.2 δ V<sub>CM</sub> δ 1.8V.

Figure 23. LVPECL Driver with Three Resistor Pack



**ispXPGA 125B/C & ispXPGA 125EB/EC External Switching Characteristics**  
Over Recommended Operating Conditions

| Parameter              | Description                  | Conditions                                                     | -5 <sup>1</sup> |      | -4   |      | -3   |      | Units |
|------------------------|------------------------------|----------------------------------------------------------------|-----------------|------|------|------|------|------|-------|
|                        |                              |                                                                | Min.            | Max. | Min. | Max. | Min. | Max. |       |
| t <sub>CO</sub>        | Global Clock Input to Output | PIO Output Register                                            | —               | 5.3  | —    | 5.7  | —    | 6.6  | ns    |
| t <sub>S</sub>         | Global Clock Input Setup     | PIO Input Register without input delay                         | -1.9            | —    | -1.8 | —    | -1.5 | —    | ns    |
| t <sub>H</sub>         | Global Clock Input Hold      | PIO Input Register without input delay                         | 2.7             | —    | 2.9  | —    | 3.3  | —    | ns    |
| t <sub>SINDLY</sub>    | Global Clock Input Setup     | PIO Input Register with input delay                            | 3.1             | —    | 3.3  | —    | 3.8  | —    | ns    |
| t <sub>HINDLY</sub>    | Global Clock Input Hold      | PIO Input Register with input delay                            | 0.0             | —    | 0.0  | —    | 0.0  | —    |       |
| t <sub>COPLL</sub>     | Global Clock Input to Output | PIO Output Register using PLL without delay                    | —               | 3.6  | —    | 3.9  | —    | 4.5  | ns    |
| t <sub>SPLL</sub>      | Global Clock Input Setup     | PIO Input Register without input delay using PLL without delay | 0               | —    | 0.1  | —    | 0.3  | —    | ns    |
| t <sub>HPLL</sub>      | Global Clock Input Hold      | PIO Input Register without input delay using PLL without delay | 0.9             | —    | 1.0  | —    | 1.2  | —    | ns    |
| t <sub>SINDLYPLL</sub> | Global Clock Input Setup     | PIO Input Register with input delay using PLL without delay    | 5.1             | —    | 5.5  | —    | 6.3  | —    | ns    |
| t <sub>HINDLYPLL</sub> | Global Clock Input Hold      | PIO Input Register with input delay using PLL without delay    | -3.0            | —    | -2.8 | —    | -2.4 | —    | ns    |

1. Only available for ispXPGA 125B and ispXPGA 125EB (2.5V/3.3V) devices.

## ispXPGA 125B/C &amp; ispXPGA 125EB/EC PFU Timing Parameters

Over Recommended Operating Conditions

| Parameter                        | Description                                             | -5 <sup>1</sup> |      | -4    |      | -3    |      | Units |
|----------------------------------|---------------------------------------------------------|-----------------|------|-------|------|-------|------|-------|
|                                  |                                                         | Min.            | Max. | Min.  | Max. | Min.  | Max. |       |
| <b>Functional Delays</b>         |                                                         |                 |      |       |      |       |      |       |
| <b>LUTs</b>                      |                                                         |                 |      |       |      |       |      |       |
| t <sub>LUT4</sub>                | 4-Input LUT Delay                                       | —               | 0.41 | —     | 0.44 | —     | 0.51 | ns    |
| t <sub>LUT5</sub>                | 5-Input LUT Delay                                       | —               | 0.73 | —     | 0.79 | —     | 0.91 | ns    |
| t <sub>LUT6</sub>                | 6-Input LUT Delay                                       | —               | 0.86 | —     | 0.93 | —     | 1.07 | ns    |
| <b>Shift Register (LUT)</b>      |                                                         |                 |      |       |      |       |      |       |
| t <sub>LSR_S</sub>               | Shift Register Setup Time                               | -0.64           | —    | -0.62 | —    | -0.53 | —    | ns    |
| t <sub>LSR_H</sub>               | Shift Register Hold Time                                | 0.61            | —    | 0.63  | —    | 0.72  | —    | ns    |
| t <sub>LSR_CO</sub>              | Shift Register Clock to Output Delay                    | —               | 0.70 | —     | 0.75 | —     | 0.86 | ns    |
| <b>Arithmetic Functions</b>      |                                                         |                 |      |       |      |       |      |       |
| t <sub>LCTHRUR</sub>             | MC (Macro Cell) Carry In to MC Carry Out Delay (Ripple) | —               | 0.08 | —     | 0.09 | —     | 0.10 | ns    |
| t <sub>LCTHRUL<sup>2</sup></sub> | MC Carry In to MC Carry Out Delay (Look Ahead)          | —               | 0.05 | —     | 0.05 | —     | 0.06 | ns    |
| t <sub>LSTHRU</sub>              | MC Sum In to MC Sum Out Delay                           | —               | 0.42 | —     | 0.45 | —     | 0.52 | ns    |
| t <sub>LSINCOUT</sub>            | MC Sum In to MC Carry Out Delay                         | —               | 0.29 | —     | 0.31 | —     | 0.36 | ns    |
| t <sub>LCINSOUTR</sub>           | MC Carry In to MC Sum Out Delay (Ripple)                | —               | 0.36 | —     | 0.39 | —     | 0.45 | ns    |
| t <sub>LCINSOUTL</sub>           | MC Carry In to MC Sum Out Delay (Look Ahead)            | —               | 0.26 | —     | 0.28 | —     | 0.32 | ns    |
| <b>Feed-thru</b>                 |                                                         |                 |      |       |      |       |      |       |
| t <sub>LFT</sub>                 | PFU Feed-Thru Delay                                     | —               | 0.15 | —     | 0.16 | —     | 0.18 | ns    |
| <b>Distributed RAM</b>           |                                                         |                 |      |       |      |       |      |       |
| t <sub>LRAM_CO</sub>             | Clock to RAM Output                                     | —               | 1.24 | —     | 1.33 | —     | 1.53 | ns    |
| t <sub>LRAMAD_S</sub>            | Address Setup Time                                      | -0.41           | —    | -0.40 | —    | -0.34 | —    | ns    |
| t <sub>LRAMD_S</sub>             | Data Setup Time                                         | 0.21            | —    | 0.22  | —    | 0.25  | —    | ns    |
| t <sub>LRAMWE_S</sub>            | Write Enable Setup Time                                 | 0.45            | —    | 0.46  | —    | 0.53  | —    | ns    |
| t <sub>LRAMAD_H</sub>            | Address Hold Time                                       | 0.58            | —    | 0.60  | —    | 0.69  | —    | ns    |
| t <sub>LRAMD_H</sub>             | Data Hold Time                                          | 0.11            | —    | 0.11  | —    | 0.13  | —    | ns    |
| t <sub>LRAMWE_H</sub>            | Write Enable Hold Time                                  | 0.12            | —    | 0.12  | —    | 0.14  | —    | ns    |
| t <sub>LRAMCPW</sub>             | Clock Pulse Width (High or Low)                         | 2.91            | —    | 3.00  | —    | 3.45  | —    | ns    |
| t <sub>LRAMADO</sub>             | Address to Output Delay                                 | —               | 0.86 | —     | 0.93 | —     | 1.07 | ns    |
| <b>Register/Latch Delays</b>     |                                                         |                 |      |       |      |       |      |       |
| <b>Registers</b>                 |                                                         |                 |      |       |      |       |      |       |
| t <sub>L_CO</sub>                | Register Clock to Output Delay                          | —               | 0.58 | —     | 0.62 | —     | 0.71 | ns    |
| t <sub>L_S</sub>                 | Register Setup Time (Data before Clock)                 | 0.14            | —    | 0.14  | —    | 0.16  | —    | ns    |
| t <sub>L_H</sub>                 | Register Hold Time (Data after Clock)                   | -0.12           | —    | -0.12 | —    | -0.10 | —    | ns    |
| t <sub>LCE_S</sub>               | Register Clock Enable Setup Time                        | -0.11           | —    | -0.11 | —    | -0.09 | —    | ns    |
| t <sub>LCE_H</sub>               | Register Clock Enable Hold Time                         | 0.11            | —    | 0.11  | —    | 0.13  | —    | ns    |
| <b>Latches</b>                   |                                                         |                 |      |       |      |       |      |       |
| t <sub>L_GO</sub>                | Latch Gate to Output Delay                              | —               | 0.09 | —     | 0.10 | —     | 0.12 | ns    |
| t <sub>LL_S</sub>                | Latch Setup Time                                        | 0.14            | —    | 0.14  | —    | 0.16  | —    | ns    |
| t <sub>LL_H</sub>                | Latch Hold Time                                         | -0.12           | —    | -0.12 | —    | -0.10 | —    | ns    |
| t <sub>LLPD</sub>                | Latch Propagation Delay (Transparent Mode)              | —               | 0.09 | —     | 0.10 | —     | 0.12 | ns    |



**ispXPGA 125B/C & ispXPGA 125EB/EC PFU Timing Parameters (Cont.)**

Over Recommended Operating Conditions

| Parameter            | Description                        | -5 <sup>1</sup> |      | -4    |      | -3    |      | Units |
|----------------------|------------------------------------|-----------------|------|-------|------|-------|------|-------|
|                      |                                    | Min.            | Max. | Min.  | Max. | Min.  | Max. |       |
| <b>Reset/Set</b>     |                                    |                 |      |       |      |       |      |       |
| t <sub>LASSRO</sub>  | Asynchronous Set/Reset to Output   | —               | 1.09 | —     | 1.17 | —     | 1.35 | ns    |
| t <sub>LASSRPW</sub> | Asynchronous Set/Reset Pulse Width | 4.19            | —    | 4.50  | —    | 5.18  | —    | ns    |
| t <sub>LASSRR</sub>  | Asynchronous Set/Reset Recovery    | —               | 0.51 | —     | 0.55 | —     | 0.63 | ns    |
| t <sub>LSSR_S</sub>  | Synchronous Set/Reset Setup Time   | -0.03           | —    | -0.03 | —    | -0.03 | —    | ns    |
| t <sub>LSSR_H</sub>  | Synchronous Set/Reset Hold Time    | 0.03            | —    | 0.03  | —    | 0.03  | —    | ns    |

1. Only available for ispXPGA 125B and ispXPGA 125EB (2.5V/3.3V) devices.

Timing v.0.3

2. t<sub>LCTHRUL</sub> quoted bit by bit.

**ispXPGA 125B/C & ispXPGA 125EB/EC PIC Timing Parameters**

| Parameter                    | Description                                | -5 <sup>1</sup> |       | -4    |       | -3    |       | Units |
|------------------------------|--------------------------------------------|-----------------|-------|-------|-------|-------|-------|-------|
|                              |                                            | Min.            | Max.  | Min.  | Max.  | Min.  | Max.  |       |
| <b>Register/Latch Delays</b> |                                            |                 |       |       |       |       |       |       |
| t <sub>IO_CO</sub>           | Register Clock to Output Delay             | —               | 0.89  | —     | 0.96  | —     | 1.10  | ns    |
| t <sub>IO_S</sub>            | Register Setup Time (Data before Clock)    | 0.05            | —     | 0.05  | —     | 0.06  | —     | ns    |
| t <sub>IO_H</sub>            | Register Hold Time (Data after Clock)      | 0.06            | —     | 0.06  | —     | 0.07  | —     | ns    |
| t <sub>IOCE_S</sub>          | Register Clock Enable Setup Time           | -0.03           | —     | -0.03 | —     | -0.03 | —     | ns    |
| t <sub>IOCE_H</sub>          | Register Clock Enable Hold Time            | 0.13            | —     | 0.13  | —     | 0.15  | —     | ns    |
| t <sub>IO_GO</sub>           | Latch Gate to Output Delay                 | —               | 0.68  | —     | 0.73  | —     | 0.84  | ns    |
| t <sub>IOL_S</sub>           | Latch Setup Time                           | 0.05            | —     | 0.05  | —     | 0.06  | —     | ns    |
| t <sub>IOL_H</sub>           | Latch Hold Time                            | 0.06            | —     | 0.06  | —     | 0.07  | —     | ns    |
| t <sub>IOLPD</sub>           | Latch Propagation Delay (Transparent Mode) | —               | 0.09  | —     | 0.10  | —     | 0.12  | ns    |
| t <sub>IOASRO</sub>          | Asynchronous Set/Reset to Output           | —               | 1.00  | —     | 1.08  | —     | 1.24  | ns    |
| t <sub>IOASRPW</sub>         | Asynchronous Set/Reset Pulse Width         | 4.19            | —     | 4.50  | —     | 5.18  | —     | ns    |
| t <sub>IOASRR</sub>          | Asynchronous Set/Reset Recovery Time       | —               | 0.23  | —     | 0.25  | —     | 0.29  | ns    |
| <b>Input/Output Delays</b>   |                                            |                 |       |       |       |       |       |       |
| t <sub>IOBUF</sub>           | Output Buffer Delay                        | —               | 0.97  | —     | 1.04  | —     | 1.20  | ns    |
| t <sub>IOIN</sub>            | Input Buffer Delay                         | —               | 0.57  | —     | 0.61  | —     | 0.70  | ns    |
| t <sub>IOEN</sub>            | Output Enable Delay                        | —               | 0.53  | —     | 0.57  | —     | 0.66  | ns    |
| t <sub>IODIS</sub>           | Output Disable Delay                       | —               | -0.14 | —     | -0.13 | —     | -0.11 | ns    |
| t <sub>IOFT</sub>            | Feed-thru Delay                            | —               | 0.19  | —     | 0.20  | —     | 0.23  | ns    |

1. Only available for ispXPGA 125B and ispXPGA 125EB (2.5V/3.3V) devices.

Timing v.0.3

**ispXPGA 125B/C & ispXPGA 125EB/EC EBR Timing Parameters**

| Parameter                | Description                          | -5 <sup>1</sup> |      | -4    |      | -3    |      | Units |
|--------------------------|--------------------------------------|-----------------|------|-------|------|-------|------|-------|
|                          |                                      | Min.            | Max. | Min.  | Max. | Min.  | Max. |       |
| <b>Synchronous Write</b> |                                      |                 |      |       |      |       |      |       |
| t <sub>EBSWAD_S</sub>    | Address Setup Delay                  | 0.59            | —    | 0.61  | —    | 0.70  | —    | ns    |
| t <sub>EBSWAD_H</sub>    | Address Hold Delay                   | -0.40           | —    | -0.39 | —    | -0.33 | —    | ns    |
| t <sub>EBSWCPW</sub>     | Clock Pulse Width                    | 3.16            | —    | 3.40  | —    | 3.91  | —    | ns    |
| t <sub>EBSWWE_S</sub>    | Write Enable Setup Time              | -0.12           | —    | -0.12 | —    | -0.10 | —    | ns    |
| t <sub>EBSWWE_H</sub>    | Write Enable Hold Time               | 0.16            | —    | 0.16  | —    | 0.18  | —    | ns    |
| t <sub>EBSWD_S</sub>     | Data Setup Time                      | 0.27            | —    | 0.28  | —    | 0.32  | —    | ns    |
| t <sub>EBSWD_H</sub>     | Data Hold Time                       | -0.27           | —    | -0.26 | —    | -0.22 | —    | ns    |
| <b>Synchronous Read</b>  |                                      |                 |      |       |      |       |      |       |
| t <sub>EBSR_CO</sub>     | Clock to Data Delay                  | —               | 2.04 | —     | 2.19 | —     | 2.52 | ns    |
| t <sub>EBSRAD_S</sub>    | Address Setup Delay                  | 0.10            | —    | 0.10  | —    | 0.12  | —    | ns    |
| t <sub>EBSRAD_H</sub>    | Address Hold Delay                   | -0.07           | —    | -0.07 | —    | -0.06 | —    | ns    |
| t <sub>EBSRCPW</sub>     | Clock Pulse Width                    | 3.16            | —    | 3.40  | —    | 3.91  | —    | ns    |
| t <sub>EBSRCE_S</sub>    | Clock Enable Setup Time              | -1.76           | —    | -1.71 | —    | -1.45 | —    | ns    |
| t <sub>EBSRCE_H</sub>    | Clock Enable Hold Time               | 1.64            | —    | 1.69  | —    | 1.94  | —    | ns    |
| t <sub>EBSRWE_S</sub>    | Write Enable Setup Time              | -0.18           | —    | -0.17 | —    | -0.14 | —    | ns    |
| t <sub>EBSRWE_H</sub>    | Write Enable Hold Time               | 0.12            | —    | 0.12  | —    | 0.14  | —    | ns    |
| t <sub>EBSRWEEN</sub>    | Write Enable to Data Enable Time     | —               | 1.02 | —     | 1.05 | —     | 1.21 | ns    |
| t <sub>EBSRWEDIS</sub>   | Write Enable to Data Disable Time    | —               | 0.99 | —     | 1.02 | —     | 1.17 | ns    |
| t <sub>EBSREN</sub>      | Output Enable to Data Enable Time    | —               | 1.02 | —     | 1.05 | —     | 1.21 | ns    |
| t <sub>EBSRDIS</sub>     | Output Enable to Data Disable Time   | —               | 0.83 | —     | 0.86 | —     | 0.99 | ns    |
| <b>Asynchronous Read</b> |                                      |                 |      |       |      |       |      |       |
| t <sub>EBARADO</sub>     | Address to New Valid Data Delay      | —               | 2.39 | —     | 2.46 | —     | 2.83 | ns    |
| t <sub>EBARAD_H</sub>    | Address to Previous Valid Data Delay | —               | 2.10 | —     | 2.17 | —     | 2.50 | ns    |
| t <sub>EBARWEEN</sub>    | Write Enable to Data Enable Time     | —               | 1.01 | —     | 1.04 | —     | 1.20 | ns    |
| t <sub>EBARWEDIS</sub>   | Write Enable to Data Disable Time    | —               | 0.98 | —     | 1.01 | —     | 1.16 | ns    |
| t <sub>EBAREN</sub>      | Output Enable to Data Enable Time    | —               | 1.02 | —     | 1.05 | —     | 1.21 | ns    |
| t <sub>EBARDIS</sub>     | Output Enable to Data Disable Time   | —               | 0.83 | —     | 0.86 | —     | 0.99 | ns    |

1. Only available for ispXPGA 125B and ispXPGA 125EB (2.5V/3.3V) devices.

ispXPGA 125B/C & ispXPGA 125EB/EC Timing Adders

| Parameter                               | Description                                          | Base Parameter                                              | -5 <sup>1</sup> |      | -4   |      | -3   |      | Units |
|-----------------------------------------|------------------------------------------------------|-------------------------------------------------------------|-----------------|------|------|------|------|------|-------|
|                                         |                                                      |                                                             | Min.            | Max. | Min. | Max. | Min. | Max. |       |
| <b>Optional Adders</b>                  |                                                      |                                                             |                 |      |      |      |      |      |       |
| t <sub>IOINDLY</sub>                    | Input Delay                                          | —                                                           | —               | 4.28 | —    | 4.6  | —    | 5.29 | ns    |
| <b>t<sub>IOI</sub> Input Adjusters</b>  |                                                      |                                                             |                 |      |      |      |      |      |       |
| LVTTTL_in                               | Using 3.3V TTL                                       | t <sub>IOIN</sub>                                           | —               | 0.5  | —    | 0.5  | —    | 0.5  | ns    |
| LVC MOS_18_in                           | Using 1.8V CMOS                                      | t <sub>IOIN</sub>                                           | —               | 0.0  | —    | 0.0  | —    | 0.0  | ns    |
| LVC MOS_25_in                           | Using 2.5V CMOS                                      | t <sub>IOIN</sub>                                           | —               | 0.3  | —    | 0.3  | —    | 0.3  | ns    |
| LVC MOS_33_in                           | Using 3.3V CMOS                                      | t <sub>IOIN</sub>                                           | —               | 0.5  | —    | 0.5  | —    | 0.5  | ns    |
| AGP_1X_in                               | Using AGP 1x                                         | t <sub>IOIN</sub>                                           | —               | 1.0  | —    | 1.0  | —    | 1.0  | ns    |
| CTT25_in                                | Using CTT 2.5V                                       | t <sub>IOIN</sub>                                           | —               | 1.0  | —    | 1.0  | —    | 1.0  | ns    |
| CTT33_in                                | Using CTT 3.3V                                       | t <sub>IOIN</sub>                                           | —               | 1.0  | —    | 1.0  | —    | 1.0  | ns    |
| GTL+_in                                 | Using GTL+                                           | t <sub>IOIN</sub>                                           | —               | 0.5  | —    | 0.5  | —    | 0.5  | ns    |
| HSTL_I_in                               | Using HSTL 2.5V, Class I                             | t <sub>IOIN</sub>                                           | —               | 0.5  | —    | 0.5  | —    | 0.5  | ns    |
| HSTL_III_in                             | Using HSTL 2.5V, Class III                           | t <sub>IOIN</sub>                                           | —               | 0.5  | —    | 0.5  | —    | 0.5  | ns    |
| LVDS_in                                 | Using Low Voltage Differential Signaling (LVDS)      | t <sub>IOIN</sub>                                           | —               | 0.8  | —    | 0.8  | —    | 0.8  | ns    |
| BLVDS_in                                | Using Bus Low Voltage Differential Signaling (BLVDS) | t <sub>IOIN</sub>                                           | —               | 0.8  | —    | 0.8  | —    | 0.8  | ns    |
| LVPECL_in                               | Using Low Voltage PECL                               | t <sub>IOIN</sub>                                           | —               | 0.8  | —    | 0.8  | —    | 0.8  | ns    |
| PCI_in                                  | Using PCI                                            | t <sub>IOIN</sub>                                           | —               | 1.0  | —    | 1.0  | —    | 1.0  | ns    |
| SSTL2_I_in                              | Using SSTL 2.5V, Class I                             | t <sub>IOIN</sub>                                           | —               | 0.8  | —    | 0.8  | —    | 0.8  | ns    |
| SSTL2_II_in                             | Using SSTL 2.5V, Class II                            | t <sub>IOIN</sub>                                           | —               | 0.5  | —    | 0.5  | —    | 0.5  | ns    |
| SSTL3_I_in                              | Using SSTL 3.3V, Class I                             | t <sub>IOIN</sub>                                           | —               | 0.8  | —    | 0.8  | —    | 0.8  | ns    |
| SSTL3_II_in                             | Using SSTL 3.3V, Class II                            | t <sub>IOIN</sub>                                           | —               | 0.8  | —    | 0.8  | —    | 0.8  | ns    |
| <b>t<sub>IOO</sub> Output Adjusters</b> |                                                      |                                                             |                 |      |      |      |      |      |       |
| Slow Slew                               | Using Slow Slew (LVTTTL and LVC MOS Outputs only)    | t <sub>IOBUF</sub> , t <sub>IOEN</sub>                      | —               | 0.7  | —    | 0.7  | —    | 0.7  | ns    |
| LVTTTL_out                              | Using 3.3V TTL Drive                                 | t <sub>IOBUF</sub> , t <sub>IOEN</sub> , t <sub>IODIS</sub> | —               | 1.0  | —    | 1.0  | —    | 1.0  | ns    |
| LVC MOS_18_4mA_out                      | Using 1.8V CMOS Standard, 4mA Drive                  | t <sub>IOBUF</sub> , t <sub>IOEN</sub> , t <sub>IODIS</sub> | —               | 0.8  | —    | 0.8  | —    | 0.8  | ns    |
| LVC MOS_18_5.33mA_out                   | Using 1.8V CMOS Standard, 5.33mA Drive               | t <sub>IOBUF</sub> , t <sub>IOEN</sub> , t <sub>IODIS</sub> | —               | 0.6  | —    | 0.6  | —    | 0.6  | ns    |
| LVC MOS_18_8mA_out                      | Using 1.8V CMOS Standard, 8mA Drive                  | t <sub>IOBUF</sub> , t <sub>IOEN</sub> , t <sub>IODIS</sub> | —               | 0.0  | —    | 0.0  | —    | 0.0  | ns    |
| LVC MOS_18_12mA_out                     | Using 1.8V CMOS Standard, 12mA Drive                 | t <sub>IOBUF</sub> , t <sub>IOEN</sub> , t <sub>IODIS</sub> | —               | 0.2  | —    | 0.2  | —    | 0.2  | ns    |
| LVC MOS_25_4mA_out                      | Using 2.5V CMOS Standard, 4mA Drive                  | t <sub>IOBUF</sub> , t <sub>IOEN</sub> , t <sub>IODIS</sub> | —               | 0.7  | —    | 0.7  | —    | 0.7  | ns    |
| LVC MOS_25_5.33mA_out                   | Using 2.5V CMOS Standard, 5.33 mA Drive              | t <sub>IOBUF</sub> , t <sub>IOEN</sub> , t <sub>IODIS</sub> | —               | 0.5  | —    | 0.5  | —    | 0.5  | ns    |
| LVC MOS_25_8mA_out                      | Using 2.5V CMOS Standard, 8mA Drive                  | t <sub>IOBUF</sub> , t <sub>IOEN</sub> , t <sub>IODIS</sub> | —               | 0.5  | —    | 0.5  | —    | 0.5  | ns    |
| LVC MOS_25_12mA_out                     | Using 2.5V CMOS Standard, 12mA Drive                 | t <sub>IOBUF</sub> , t <sub>IOEN</sub> , t <sub>IODIS</sub> | —               | 0.5  | —    | 0.5  | —    | 0.5  | ns    |
| LVC MOS_25_16mA_out                     | Using 2.5V CMOS Standard, 16mA Drive                 | t <sub>IOBUF</sub> , t <sub>IOEN</sub> , t <sub>IODIS</sub> | —               | 0.5  | —    | 0.5  | —    | 0.5  | ns    |

## ispXPGA 125B/C &amp; ispXPGA 125EB/EC Timing Adders (Cont.)

| Parameter             | Description                                          | Base Parameter                                              | -5 <sup>1</sup> |      | -4   |      | -3   |      | Units |
|-----------------------|------------------------------------------------------|-------------------------------------------------------------|-----------------|------|------|------|------|------|-------|
|                       |                                                      |                                                             | Min.            | Max. | Min. | Max. | Min. | Max. |       |
| LVC MOS_33_4mA_out    | Using 3.3V CMOS Standard, 4mA Drive                  | t <sub>IOBUF</sub> , t <sub>IOEN</sub> , t <sub>IODIS</sub> | —               | 1.0  | —    | 1.0  | —    | 1.0  | ns    |
| LVC MOS_33_5.33mA_out | Using 3.3V CMOS Standard, 5.33mA Drive               | t <sub>IOBUF</sub> , t <sub>IOEN</sub> , t <sub>IODIS</sub> | —               | 1.0  | —    | 1.0  | —    | 1.0  | ns    |
| LVC MOS_33_8mA_out    | Using 3.3V CMOS Standard, 8mA Drive                  | t <sub>IOBUF</sub> , t <sub>IOEN</sub> , t <sub>IODIS</sub> | —               | 0.7  | —    | 0.7  | —    | 0.7  | ns    |
| LVC MOS_33_12mA_out   | Using 3.3V CMOS Standard, 12mA Drive                 | t <sub>IOBUF</sub> , t <sub>IOEN</sub> , t <sub>IODIS</sub> | —               | 0.5  | —    | 0.5  | —    | 0.5  | ns    |
| LVC MOS_33_16mA_out   | Using 3.3V CMOS Standard, 16mA Drive                 | t <sub>IOBUF</sub> , t <sub>IOEN</sub> , t <sub>IODIS</sub> | —               | 0.5  | —    | 0.5  | —    | 0.5  | ns    |
| LVC MOS_33_24mA_out   | Using 3.3V CMOS Standard, 24mA Drive                 | t <sub>IOBUF</sub> , t <sub>IOEN</sub> , t <sub>IODIS</sub> | —               | 0.5  | —    | 0.5  | —    | 0.5  | ns    |
| AGP_1X_out            | Using AGP 1x Standard                                | t <sub>IOBUF</sub> , t <sub>IOEN</sub> , t <sub>IODIS</sub> | —               | 0.5  | —    | 0.5  | —    | 0.5  | ns    |
| CTT25_out             | Using CTT 2.5V                                       | t <sub>IOBUF</sub> , t <sub>IOEN</sub> , t <sub>IODIS</sub> | —               | 0.5  | —    | 0.5  | —    | 0.5  | ns    |
| CTT33_out             | Using CTT 3.3V                                       | t <sub>IOBUF</sub> , t <sub>IOEN</sub> , t <sub>IODIS</sub> | —               | 0.5  | —    | 0.5  | —    | 0.5  | ns    |
| GTL+_out              | Using GTL+                                           | t <sub>IOBUF</sub> , t <sub>IOEN</sub> , t <sub>IODIS</sub> | —               | 0.5  | —    | 0.5  | —    | 0.5  | ns    |
| HSTL_I_out            | Using HSTL 2.5V, Class I                             | t <sub>IOBUF</sub> , t <sub>IOEN</sub> , t <sub>IODIS</sub> | —               | 0.5  | —    | 0.5  | —    | 0.5  | ns    |
| HSTL_III_out          | Using HSTL 2.5V, Class III                           | t <sub>IOBUF</sub> , t <sub>IOEN</sub> , t <sub>IODIS</sub> | —               | 0.5  | —    | 0.5  | —    | 0.5  | ns    |
| LVDS_out              | Using Low Voltage Differential Signaling (LVDS)      | t <sub>IOBUF</sub> , t <sub>IOEN</sub> , t <sub>IODIS</sub> | —               | 1.0  | —    | 1.0  | —    | 1.0  | ns    |
| BLVDS_out             | Using Bus Low Voltage Differential Signaling (BLVDS) | t <sub>IOBUF</sub> , t <sub>IOEN</sub> , t <sub>IODIS</sub> | —               | 1.0  | —    | 1.0  | —    | 1.0  | ns    |
| LVPECL_out            | Using Low Voltage PECL                               | t <sub>IOBUF</sub> , t <sub>IOEN</sub> , t <sub>IODIS</sub> | —               | 1.0  | —    | 1.0  | —    | 1.0  | ns    |
| PCI_out               | Using PCI Standard                                   | t <sub>IOBUF</sub> , t <sub>IOEN</sub> , t <sub>IODIS</sub> | —               | 0.5  | —    | 0.5  | —    | 0.5  | ns    |
| SSTL2_I_out           | Using SSTL 2.5V, Class I                             | t <sub>IOBUF</sub> , t <sub>IOEN</sub> , t <sub>IODIS</sub> | —               | 0.5  | —    | 0.5  | —    | 0.5  | ns    |
| SSTL2_II_out          | Using SSTL 2.5V, Class II                            | t <sub>IOBUF</sub> , t <sub>IOEN</sub> , t <sub>IODIS</sub> | —               | 0.5  | —    | 0.5  | —    | 0.5  | ns    |
| SSTL3_I_out           | Using SSTL 3.3V, Class I                             | t <sub>IOBUF</sub> , t <sub>IOEN</sub> , t <sub>IODIS</sub> | —               | 0.5  | —    | 0.5  | —    | 0.5  | ns    |
| SSTL3_II_out          | Using SSTL 3.3V, Class II                            | t <sub>IOBUF</sub> , t <sub>IOEN</sub> , t <sub>IODIS</sub> | —               | 0.5  | —    | 0.5  | —    | 0.5  | ns    |

1. Only available for ispXPGA 125B and ispXPGA 125EB (2.5V/3.3V) devices.

Timing v.0.3

**ispXPGA 200B/C & ispXPGA 200EB/EC External Switching Characteristics**  
**Over Recommended Operating Conditions**

| Parameter              | Description                  | Conditions                                                     | -5 <sup>1</sup> |      | -4   |      | -3   |      | Units |
|------------------------|------------------------------|----------------------------------------------------------------|-----------------|------|------|------|------|------|-------|
|                        |                              |                                                                | Min.            | Max. | Min. | Max. | Min. | Max. |       |
| t <sub>CO</sub>        | Global Clock Input to Output | PIO Output Register                                            | —               | 5.5  | —    | 5.9  | —    | 6.8  | ns    |
| t <sub>S</sub>         | Global Clock Input Setup     | PIO Input Register without input delay                         | -2.0            | —    | -2.0 | —    | -1.7 | —    | ns    |
| t <sub>H</sub>         | Global Clock Input Hold      | PIO Input Register without input delay                         | 3.7             | —    | 3.8  | —    | 4.4  | —    | ns    |
| t <sub>SINDLY</sub>    | Global Clock Input Setup     | PIO Input Register with input delay                            | 3.8             | —    | 3.8  | —    | 4.4  | —    | ns    |
| t <sub>HINDLY</sub>    | Global Clock Input Hold      | PIO Input Register with input delay                            | 0.0             | —    | 0.0  | —    | 0.0  | —    |       |
| t <sub>COPLL</sub>     | Global Clock Input to Output | PIO Output Register using PLL without delay                    | —               | 3.3  | —    | 3.6  | —    | 4.2  | ns    |
| t <sub>SPLL</sub>      | Global Clock Input Setup     | PIO Input Register without input delay using PLL without delay | -0.2            | —    | -0.2 | —    | 0.1  | —    | ns    |
| t <sub>HPLL</sub>      | Global Clock Input Hold      | PIO Input Register without input delay using PLL without delay | 1.5             | —    | 1.5  | —    | 1.8  | —    | ns    |
| t <sub>SINDLYPLL</sub> | Global Clock Input Setup     | PIO Input Register with input delay using PLL without delay    | 6.3             | —    | 6.3  | —    | 7.3  | —    | ns    |
| t <sub>HINDLYPLL</sub> | Global Clock Input Hold      | PIO Input Register with input delay using PLL without delay    | -2.7            | —    | -2.6 | —    | -2.2 | —    | ns    |

1. Only available for ispXPGA 200B and ispXPGA 200EB (2.5V/3.3V) devices.

Timing v.0.2

SELECTED  
DISCONTINUED

## ispXPGA 200B/C &amp; ispXPGA 200EB/EC PFU Timing Parameters

Over Recommended Operating Conditions

| Parameter                        | Description                                             | -5 <sup>1</sup> |      | -4    |      | -3    |      | Units |
|----------------------------------|---------------------------------------------------------|-----------------|------|-------|------|-------|------|-------|
|                                  |                                                         | Min.            | Max. | Min.  | Max. | Min.  | Max. |       |
| <b>Functional Delays</b>         |                                                         |                 |      |       |      |       |      |       |
| <b>LUTs</b>                      |                                                         |                 |      |       |      |       |      |       |
| t <sub>LUT4</sub>                | 4-Input LUT Delay                                       | —               | 0.41 | —     | 0.44 | —     | 0.51 | ns    |
| t <sub>LUT5</sub>                | 5-Input LUT Delay                                       | —               | 0.73 | —     | 0.79 | —     | 0.91 | ns    |
| t <sub>LUT6</sub>                | 6-Input LUT Delay                                       | —               | 0.86 | —     | 0.93 | —     | 1.07 | ns    |
| <b>Shift Register (LUT)</b>      |                                                         |                 |      |       |      |       |      |       |
| t <sub>LSR_S</sub>               | Shift Register Setup Time                               | -0.64           | —    | -0.62 | —    | -0.53 | —    | ns    |
| t <sub>LSR_H</sub>               | Shift Register Hold Time                                | 0.61            | —    | 0.63  | —    | 0.72  | —    | ns    |
| t <sub>LSR_CO</sub>              | Shift Register Clock to Output Delay                    | —               | 0.70 | —     | 0.75 | —     | 0.86 | ns    |
| <b>Arithmetic Functions</b>      |                                                         |                 |      |       |      |       |      |       |
| t <sub>LCTHRUR</sub>             | MC (Macro Cell) Carry In to MC Carry Out Delay (Ripple) | —               | 0.08 | —     | 0.09 | —     | 0.10 | ns    |
| t <sub>LCTHRUL<sup>2</sup></sub> | MC Carry In to MC Carry Out Delay (Look Ahead)          | —               | 0.05 | —     | 0.05 | —     | 0.06 | ns    |
| t <sub>LSTHRU</sub>              | MC Sum In to MC Sum Out Delay                           | —               | 0.42 | —     | 0.45 | —     | 0.52 | ns    |
| t <sub>LSINCOUT</sub>            | MC Sum In to MC Carry Out Delay                         | —               | 0.29 | —     | 0.31 | —     | 0.36 | ns    |
| t <sub>LCINSOUTR</sub>           | MC Carry In to MC Sum Out Delay (Ripple)                | —               | 0.36 | —     | 0.39 | —     | 0.45 | ns    |
| t <sub>LCINSOUTL</sub>           | MC Carry In to MC Sum Out Delay (Look Ahead)            | —               | 0.26 | —     | 0.28 | —     | 0.32 | ns    |
| <b>Feed-thru</b>                 |                                                         |                 |      |       |      |       |      |       |
| t <sub>LFT</sub>                 | PFU Feed-Thru Delay                                     | —               | 0.15 | —     | 0.16 | —     | 0.18 | ns    |
| <b>Distributed RAM</b>           |                                                         |                 |      |       |      |       |      |       |
| t <sub>LRAM_CO</sub>             | Clock to RAM Output                                     | —               | 1.24 | —     | 1.33 | —     | 1.53 | ns    |
| t <sub>LRAMAD_S</sub>            | Address Setup Time                                      | -0.41           | —    | -0.40 | —    | -0.34 | —    | ns    |
| t <sub>LRAMD_S</sub>             | Data Setup Time                                         | 0.21            | —    | 0.22  | —    | 0.25  | —    | ns    |
| t <sub>LRAMWE_S</sub>            | Write Enable Setup Time                                 | 0.45            | —    | 0.46  | —    | 0.53  | —    | ns    |
| t <sub>LRAMAD_H</sub>            | Address Hold Time                                       | 0.58            | —    | 0.60  | —    | 0.69  | —    | ns    |
| t <sub>LRAMD_H</sub>             | Data Hold Time                                          | 0.11            | —    | 0.11  | —    | 0.13  | —    | ns    |
| t <sub>LRAMWE_H</sub>            | Write Enable Hold Time                                  | 0.12            | —    | 0.12  | —    | 0.14  | —    | ns    |
| t <sub>LRAMCPW</sub>             | Clock Pulse Width (High or Low)                         | 2.91            | —    | 3.00  | —    | 3.45  | —    | ns    |
| t <sub>LRAMADO</sub>             | Address to Output Delay                                 | —               | 0.86 | —     | 0.93 | —     | 1.07 | ns    |
| <b>Register/Latch Delays</b>     |                                                         |                 |      |       |      |       |      |       |
| <b>Registers</b>                 |                                                         |                 |      |       |      |       |      |       |
| t <sub>L_CO</sub>                | Register Clock to Output Delay                          | —               | 0.58 | —     | 0.62 | —     | 0.71 | ns    |
| t <sub>L_S</sub>                 | Register Setup Time (Data before Clock)                 | 0.14            | —    | 0.14  | —    | 0.16  | —    | ns    |
| t <sub>L_H</sub>                 | Register Hold Time (Data after Clock)                   | -0.12           | —    | -0.12 | —    | -0.10 | —    | ns    |
| t <sub>LCE_S</sub>               | Register Clock Enable Setup Time                        | -0.11           | —    | -0.11 | —    | -0.09 | —    | ns    |
| t <sub>LCE_H</sub>               | Register Clock Enable Hold Time                         | 0.11            | —    | 0.11  | —    | 0.13  | —    | ns    |
| <b>Latches</b>                   |                                                         |                 |      |       |      |       |      |       |
| t <sub>L_GO</sub>                | Latch Gate to Output Delay                              | —               | 0.09 | —     | 0.10 | —     | 0.12 | ns    |
| t <sub>LL_S</sub>                | Latch Setup Time                                        | 0.14            | —    | 0.14  | —    | 0.16  | —    | ns    |
| t <sub>LL_H</sub>                | Latch Hold Time                                         | -0.12           | —    | -0.12 | —    | -0.10 | —    | ns    |
| t <sub>LLPD</sub>                | Latch Propagation Delay (Transparent Mode)              | —               | 0.09 | —     | 0.10 | —     | 0.12 | ns    |

**ispXPGA 200B/C & ispXPGA 200EB/EC PFU Timing Parameters (Cont.)**

Over Recommended Operating Conditions

| Parameter            | Description                        | -5 <sup>1</sup> |      | -4    |      | -3    |      | Units |
|----------------------|------------------------------------|-----------------|------|-------|------|-------|------|-------|
|                      |                                    | Min.            | Max. | Min.  | Max. | Min.  | Max. |       |
| <b>Reset/Set</b>     |                                    |                 |      |       |      |       |      |       |
| t <sub>LASSRO</sub>  | Asynchronous Set/Reset to Output   | —               | 1.09 | —     | 1.17 | —     | 1.35 | ns    |
| t <sub>LASSRPW</sub> | Asynchronous Set/Reset Pulse Width | 4.19            | —    | 4.50  | —    | 5.18  | —    | ns    |
| t <sub>LASSRR</sub>  | Asynchronous Set/Reset Recovery    | —               | 0.51 | —     | 0.55 | —     | 0.63 | ns    |
| t <sub>LSSR_S</sub>  | Synchronous Set/Reset Setup Time   | -0.03           | —    | -0.03 | —    | -0.03 | —    | ns    |
| t <sub>LSSR_H</sub>  | Synchronous Set/Reset Hold Time    | 0.03            | —    | 0.03  | —    | 0.03  | —    | ns    |

1. Only available for ispXPGA 200B and ispXPGA 200EB (2.5V/3.3V) devices.

Timing v.0.3

2. t<sub>LCTHRUL</sub> quoted bit by bit.

**ispXPGA 200B/C & ispXPGA 200EB/EC PIC Timing Parameters**

| Parameter                    | Description                                | -5 <sup>1</sup> |       | -4    |       | -3    |       | Units |
|------------------------------|--------------------------------------------|-----------------|-------|-------|-------|-------|-------|-------|
|                              |                                            | Min.            | Max.  | Min.  | Max.  | Min.  | Max.  |       |
| <b>Register/Latch Delays</b> |                                            |                 |       |       |       |       |       |       |
| t <sub>IO_CO</sub>           | Register Clock to Output Delay             | —               | 0.93  | —     | 1.00  | —     | 1.15  | ns    |
| t <sub>IO_S</sub>            | Register Setup Time (Data before Clock)    | 0.05            | —     | 0.05  | —     | 0.06  | —     | ns    |
| t <sub>IO_H</sub>            | Register Hold Time (Data after Clock)      | 0.06            | —     | 0.06  | —     | 0.07  | —     | ns    |
| t <sub>IOCE_S</sub>          | Register Clock Enable Setup Time           | -0.03           | —     | -0.03 | —     | -0.03 | —     | ns    |
| t <sub>IOCE_H</sub>          | Register Clock Enable Hold Time            | 0.13            | —     | 0.13  | —     | 0.15  | —     | ns    |
| t <sub>IO_GO</sub>           | Latch Gate to Output Delay                 | —               | 0.72  | —     | 0.77  | —     | 0.89  | ns    |
| t <sub>IOL_S</sub>           | Latch Setup Time                           | 0.05            | —     | 0.05  | —     | 0.06  | —     | ns    |
| t <sub>IOL_H</sub>           | Latch Hold Time                            | 0.06            | —     | 0.06  | —     | 0.07  | —     | ns    |
| t <sub>IOLPD</sub>           | Latch Propagation Delay (Transparent Mode) | —               | 0.09  | —     | 0.10  | —     | 0.12  | ns    |
| t <sub>IOASRO</sub>          | Asynchronous Set/Reset to Output           | —               | 1.04  | —     | 1.12  | —     | 1.29  | ns    |
| t <sub>IOASRPW</sub>         | Asynchronous Set/Reset Pulse Width         | 4.19            | —     | 4.50  | —     | 5.18  | —     | ns    |
| t <sub>IOASRR</sub>          | Asynchronous Set/Reset Recovery Time       | —               | 0.23  | —     | 0.25  | —     | 0.29  | ns    |
| <b>Input/Output Delays</b>   |                                            |                 |       |       |       |       |       |       |
| t <sub>IOBUF</sub>           | Output Buffer Delay                        | —               | 0.97  | —     | 1.04  | —     | 1.20  | ns    |
| t <sub>IOIN</sub>            | Input Buffer Delay                         | —               | 0.60  | —     | 0.64  | —     | 0.74  | ns    |
| t <sub>IOEN</sub>            | Output Enable Delay                        | —               | 0.53  | —     | 0.57  | —     | 0.66  | ns    |
| t <sub>IODIS</sub>           | Output Disable Delay                       | —               | -0.13 | —     | -0.12 | —     | -0.10 | ns    |
| t <sub>IOFT</sub>            | Feed-thru Delay                            | —               | 0.19  | —     | 0.20  | —     | 0.23  | ns    |

1. Only available for ispXPGA 200B and ispXPGA 200EB (2.5V/3.3V) devices.

Timing v.0.3

## ispXPGA 200B/C &amp; ispXPGA 200EB/EC EBR Timing Parameters

| Parameter                | Description                          | -5 <sup>1</sup> |      | -4    |      | -3    |      | Units |
|--------------------------|--------------------------------------|-----------------|------|-------|------|-------|------|-------|
|                          |                                      | Min.            | Max. | Min.  | Max. | Min.  | Max. |       |
| <b>Synchronous Write</b> |                                      |                 |      |       |      |       |      |       |
| t <sub>EBSWAD_S</sub>    | Address Setup Delay                  | 0.59            | —    | 0.61  | —    | 0.70  | —    | ns    |
| t <sub>EBSWAD_H</sub>    | Address Hold Delay                   | -0.40           | —    | -0.39 | —    | -0.33 | —    | ns    |
| t <sub>EBSWCPW</sub>     | Clock Pulse Width                    | 3.16            | —    | 3.40  | —    | 3.91  | —    | ns    |
| t <sub>EBSWWE_S</sub>    | Write Enable Setup Time              | -0.12           | —    | -0.12 | —    | -0.10 | —    | ns    |
| t <sub>EBSWWE_H</sub>    | Write Enable Hold Time               | 0.16            | —    | 0.16  | —    | 0.18  | —    | ns    |
| t <sub>EBSWD_S</sub>     | Data Setup Time                      | 0.27            | —    | 0.28  | —    | 0.32  | —    | ns    |
| t <sub>EBSWD_H</sub>     | Data Hold Time                       | -0.27           | —    | -0.26 | —    | -0.22 | —    | ns    |
| <b>Synchronous Read</b>  |                                      |                 |      |       |      |       |      |       |
| t <sub>EBSR_CO</sub>     | Clock to Data Delay                  | —               | 2.04 | —     | 2.19 | —     | 2.52 | ns    |
| t <sub>EBSRAD_S</sub>    | Address Setup Delay                  | 0.10            | —    | 0.10  | —    | 0.12  | —    | ns    |
| t <sub>EBSRAD_H</sub>    | Address Hold Delay                   | -0.07           | —    | -0.07 | —    | -0.06 | —    | ns    |
| t <sub>EBSRCPW</sub>     | Clock Pulse Width                    | 3.16            | —    | 3.40  | —    | 3.91  | —    | ns    |
| t <sub>EBSRCE_S</sub>    | Clock Enable Setup Time              | -1.76           | —    | -1.71 | —    | -1.45 | —    | ns    |
| t <sub>EBSRCE_H</sub>    | Clock Enable Hold Time               | 1.64            | —    | 1.69  | —    | 1.94  | —    | ns    |
| t <sub>EBSRWE_S</sub>    | Write Enable Setup Time              | -0.18           | —    | -0.17 | —    | -0.14 | —    | ns    |
| t <sub>EBSRWE_H</sub>    | Write Enable Hold Time               | 0.12            | —    | 0.12  | —    | 0.14  | —    | ns    |
| t <sub>EBSRWEEN</sub>    | Write Enable to Data Enable Time     | —               | 1.02 | —     | 1.05 | —     | 1.21 | ns    |
| t <sub>EBSRWEDIS</sub>   | Write Enable to Data Disable Time    | —               | 0.99 | —     | 1.02 | —     | 1.17 | ns    |
| t <sub>EBSREN</sub>      | Output Enable to Data Enable Time    | —               | 1.02 | —     | 1.05 | —     | 1.21 | ns    |
| t <sub>EBSRDIS</sub>     | Output Enable to Data Disable Time   | —               | 0.83 | —     | 0.86 | —     | 0.99 | ns    |
| <b>Asynchronous Read</b> |                                      |                 |      |       |      |       |      |       |
| t <sub>EBARADO</sub>     | Address to New Valid Data Delay      | —               | 2.39 | —     | 2.46 | —     | 2.83 | ns    |
| t <sub>EBARAD_H</sub>    | Address to Previous Valid Data Delay | —               | 2.10 | —     | 2.17 | —     | 2.50 | ns    |
| t <sub>EBARWEEN</sub>    | Write Enable to Data Enable Time     | —               | 1.01 | —     | 1.04 | —     | 1.20 | ns    |
| t <sub>EBARWEDIS</sub>   | Write Enable to Data Disable Time    | —               | 0.98 | —     | 1.01 | —     | 1.16 | ns    |
| t <sub>EBAREN</sub>      | Output Enable to Data Enable Time    | —               | 1.02 | —     | 1.05 | —     | 1.21 | ns    |
| t <sub>EBARDIS</sub>     | Output Enable to Data Disable Time   | —               | 0.83 | —     | 0.86 | —     | 0.99 | ns    |

1. Only available for ispXPGA 200B and ispXPGA 200EB (2.5V/3.3V) devices.

Timing v.0.3



**ispXPGA 200B/C & ispXPGA 200EB/EC Timing Adders**

| Parameter                               | Description                                          | Base Parameter                                              | -5 <sup>1</sup> |      | -4   |      | -3   |      | Units |
|-----------------------------------------|------------------------------------------------------|-------------------------------------------------------------|-----------------|------|------|------|------|------|-------|
|                                         |                                                      |                                                             | Min.            | Max. | Min. | Max. | Min. | Max. |       |
| <b>Optional Adders</b>                  |                                                      |                                                             |                 |      |      |      |      |      |       |
| t <sub>IOINDLY</sub>                    | Input Delay                                          | —                                                           | —               | 4.84 | —    | 5.2  | —    | 5.98 | ns    |
| <b>t<sub>IOI</sub> Input Adjusters</b>  |                                                      |                                                             |                 |      |      |      |      |      |       |
| LVTTTL_in                               | Using 3.3V TTL                                       | t <sub>IOIN</sub>                                           | —               | 0.5  | —    | 0.5  | —    | 0.5  | ns    |
| LVC MOS_18_in                           | Using 1.8V CMOS                                      | t <sub>IOIN</sub>                                           | —               | 0.0  | —    | 0.0  | —    | 0.0  | ns    |
| LVC MOS_25_in                           | Using 2.5V CMOS                                      | t <sub>IOIN</sub>                                           | —               | 0.3  | —    | 0.3  | —    | 0.3  | ns    |
| LVC MOS_33_in                           | Using 3.3V CMOS                                      | t <sub>IOIN</sub>                                           | —               | 0.5  | —    | 0.5  | —    | 0.5  | ns    |
| AGP_1X_in                               | Using AGP 1x                                         | t <sub>IOIN</sub>                                           | —               | 1.0  | —    | 1.0  | —    | 1.0  | ns    |
| CTT25_in                                | Using CTT 2.5V                                       | t <sub>IOIN</sub>                                           | —               | 1.0  | —    | 1.0  | —    | 1.0  | ns    |
| CTT33_in                                | Using CTT 3.3V                                       | t <sub>IOIN</sub>                                           | —               | 1.0  | —    | 1.0  | —    | 1.0  | ns    |
| GTL+_in                                 | Using GTL+                                           | t <sub>IOIN</sub>                                           | —               | 0.5  | —    | 0.5  | —    | 0.5  | ns    |
| HSTL_I_in                               | Using HSTL 2.5V, Class I                             | t <sub>IOIN</sub>                                           | —               | 0.5  | —    | 0.5  | —    | 0.5  | ns    |
| HSTL_III_in                             | Using HSTL 2.5V, Class III                           | t <sub>IOIN</sub>                                           | —               | 0.5  | —    | 0.5  | —    | 0.5  | ns    |
| LVDS_in                                 | Using Low Voltage Differential Signaling (LVDS)      | t <sub>IOIN</sub>                                           | —               | 0.8  | —    | 0.8  | —    | 0.8  | ns    |
| BLVDS_in                                | Using Bus Low Voltage Differential Signaling (BLVDS) | t <sub>IOIN</sub>                                           | —               | 0.8  | —    | 0.8  | —    | 0.8  | ns    |
| LVPECL_in                               | Using Low Voltage PECL                               | t <sub>IOIN</sub>                                           | —               | 0.8  | —    | 0.8  | —    | 0.8  | ns    |
| PCI_in                                  | Using PCI                                            | t <sub>IOIN</sub>                                           | —               | 1.0  | —    | 1.0  | —    | 1.0  | ns    |
| SSTL2_I_in                              | Using SSTL 2.5V, Class I                             | t <sub>IOIN</sub>                                           | —               | 0.8  | —    | 0.8  | —    | 0.8  | ns    |
| SSTL2_II_in                             | Using SSTL 2.5V, Class II                            | t <sub>IOIN</sub>                                           | —               | 0.5  | —    | 0.5  | —    | 0.5  | ns    |
| SSTL3_I_in                              | Using SSTL 3.3V, Class I                             | t <sub>IOIN</sub>                                           | —               | 0.8  | —    | 0.8  | —    | 0.8  | ns    |
| SSTL3_II_in                             | Using SSTL 3.3V, Class II                            | t <sub>IOIN</sub>                                           | —               | 0.8  | —    | 0.8  | —    | 0.8  | ns    |
| <b>t<sub>IOO</sub> Output Adjusters</b> |                                                      |                                                             |                 |      |      |      |      |      |       |
| Slow Slew                               | Using Slow Slew (LVTTTL and LVC MOS Outputs only)    | t <sub>IOBUF</sub> , t <sub>IOEN</sub>                      | —               | 0.7  | —    | 0.7  | —    | 0.7  | ns    |
| LVTTTL_out                              | Using 3.3V TTL Drive                                 | t <sub>IOBUF</sub> , t <sub>IOEN</sub> , t <sub>IODIS</sub> | —               | 1.0  | —    | 1.0  | —    | 1.0  | ns    |
| LVC MOS_18_4mA_out                      | Using 1.8V CMOS Standard, 4mA Drive                  | t <sub>IOBUF</sub> , t <sub>IOEN</sub> , t <sub>IODIS</sub> | —               | 0.8  | —    | 0.8  | —    | 0.8  | ns    |
| LVC MOS_18_5.33mA_out                   | Using 1.8V CMOS Standard, 5.33mA Drive               | t <sub>IOBUF</sub> , t <sub>IOEN</sub> , t <sub>IODIS</sub> | —               | 0.6  | —    | 0.6  | —    | 0.6  | ns    |
| LVC MOS_18_8mA_out                      | Using 1.8V CMOS Standard, 8mA Drive                  | t <sub>IOBUF</sub> , t <sub>IOEN</sub> , t <sub>IODIS</sub> | —               | 0.0  | —    | 0.0  | —    | 0.0  | ns    |
| LVC MOS_18_12mA_out                     | Using 1.8V CMOS Standard, 12mA Drive                 | t <sub>IOBUF</sub> , t <sub>IOEN</sub> , t <sub>IODIS</sub> | —               | 0.2  | —    | 0.2  | —    | 0.2  | ns    |
| LVC MOS_25_4mA_out                      | Using 2.5V CMOS Standard, 4mA Drive                  | t <sub>IOBUF</sub> , t <sub>IOEN</sub> , t <sub>IODIS</sub> | —               | 0.7  | —    | 0.7  | —    | 0.7  | ns    |
| LVC MOS_25_5.33mA_out                   | Using 2.5V CMOS Standard, 5.33 mA Drive              | t <sub>IOBUF</sub> , t <sub>IOEN</sub> , t <sub>IODIS</sub> | —               | 0.5  | —    | 0.5  | —    | 0.5  | ns    |
| LVC MOS_25_8mA_out                      | Using 2.5V CMOS Standard, 8mA Drive                  | t <sub>IOBUF</sub> , t <sub>IOEN</sub> , t <sub>IODIS</sub> | —               | 0.5  | —    | 0.5  | —    | 0.5  | ns    |
| LVC MOS_25_12mA_out                     | Using 2.5V CMOS Standard, 12mA Drive                 | t <sub>IOBUF</sub> , t <sub>IOEN</sub> , t <sub>IODIS</sub> | —               | 0.5  | —    | 0.5  | —    | 0.5  | ns    |
| LVC MOS_25_16mA_out                     | Using 2.5V CMOS Standard, 16mA Drive                 | t <sub>IOBUF</sub> , t <sub>IOEN</sub> , t <sub>IODIS</sub> | —               | 0.5  | —    | 0.5  | —    | 0.5  | ns    |

## ispXPGA 200B/C &amp; ispXPGA 200EB/EC Timing Adders (Cont.)

| Parameter             | Description                                          | Base Parameter                                              | -5 <sup>1</sup> |      | -4   |      | -3   |      | Units |
|-----------------------|------------------------------------------------------|-------------------------------------------------------------|-----------------|------|------|------|------|------|-------|
|                       |                                                      |                                                             | Min.            | Max. | Min. | Max. | Min. | Max. |       |
| LVC MOS_33_4mA_out    | Using 3.3V CMOS Standard, 4mA Drive                  | t <sub>IOBUF</sub> , t <sub>IOEN</sub> , t <sub>IODIS</sub> | —               | 1.0  | —    | 1.0  | —    | 1.0  | ns    |
| LVC MOS_33_5.33mA_out | Using 3.3V CMOS Standard, 5.33mA Drive               | t <sub>IOBUF</sub> , t <sub>IOEN</sub> , t <sub>IODIS</sub> | —               | 1.0  | —    | 1.0  | —    | 1.0  | ns    |
| LVC MOS_33_8mA_out    | Using 3.3V CMOS Standard, 8mA Drive                  | t <sub>IOBUF</sub> , t <sub>IOEN</sub> , t <sub>IODIS</sub> | —               | 0.7  | —    | 0.7  | —    | 0.7  | ns    |
| LVC MOS_33_12mA_out   | Using 3.3V CMOS Standard, 12mA Drive                 | t <sub>IOBUF</sub> , t <sub>IOEN</sub> , t <sub>IODIS</sub> | —               | 0.5  | —    | 0.5  | —    | 0.5  | ns    |
| LVC MOS_33_16mA_out   | Using 3.3V CMOS Standard, 16mA Drive                 | t <sub>IOBUF</sub> , t <sub>IOEN</sub> , t <sub>IODIS</sub> | —               | 0.5  | —    | 0.5  | —    | 0.5  | ns    |
| LVC MOS_33_24mA_out   | Using 3.3V CMOS Standard, 24mA Drive                 | t <sub>IOBUF</sub> , t <sub>IOEN</sub> , t <sub>IODIS</sub> | —               | 0.5  | —    | 0.5  | —    | 0.5  | ns    |
| AGP_1X_out            | Using AGP 1x Standard                                | t <sub>IOBUF</sub> , t <sub>IOEN</sub> , t <sub>IODIS</sub> | —               | 0.5  | —    | 0.5  | —    | 0.5  | ns    |
| CTT25_out             | Using CTT 2.5V                                       | t <sub>IOBUF</sub> , t <sub>IOEN</sub> , t <sub>IODIS</sub> | —               | 0.5  | —    | 0.5  | —    | 0.5  | ns    |
| CTT33_out             | Using CTT 3.3V                                       | t <sub>IOBUF</sub> , t <sub>IOEN</sub> , t <sub>IODIS</sub> | —               | 0.5  | —    | 0.5  | —    | 0.5  | ns    |
| GTL+_out              | Using GTL+                                           | t <sub>IOBUF</sub> , t <sub>IOEN</sub> , t <sub>IODIS</sub> | —               | 0.5  | —    | 0.5  | —    | 0.5  | ns    |
| HSTL_I_out            | Using HSTL 2.5V, Class I                             | t <sub>IOBUF</sub> , t <sub>IOEN</sub> , t <sub>IODIS</sub> | —               | 0.5  | —    | 0.5  | —    | 0.5  | ns    |
| HSTL_III_out          | Using HSTL 2.5V, Class III                           | t <sub>IOBUF</sub> , t <sub>IOEN</sub> , t <sub>IODIS</sub> | —               | 0.5  | —    | 0.5  | —    | 0.5  | ns    |
| LVDS_out              | Using Low Voltage Differential Signaling (LVDS)      | t <sub>IOBUF</sub> , t <sub>IOEN</sub> , t <sub>IODIS</sub> | —               | 1.0  | —    | 1.0  | —    | 1.0  | ns    |
| BLVDS_out             | Using Bus Low Voltage Differential Signaling (BLVDS) | t <sub>IOBUF</sub> , t <sub>IOEN</sub> , t <sub>IODIS</sub> | —               | 1.0  | —    | 1.0  | —    | 1.0  | ns    |
| LVPECL_out            | Using Low Voltage PECL                               | t <sub>IOBUF</sub> , t <sub>IOEN</sub> , t <sub>IODIS</sub> | —               | 1.0  | —    | 1.0  | —    | 1.0  | ns    |
| PCI_out               | Using PCI Standard                                   | t <sub>IOBUF</sub> , t <sub>IOEN</sub> , t <sub>IODIS</sub> | —               | 0.5  | —    | 0.5  | —    | 0.5  | ns    |
| SSTL2_I_out           | Using SSTL 2.5V, Class I                             | t <sub>IOBUF</sub> , t <sub>IOEN</sub> , t <sub>IODIS</sub> | —               | 0.5  | —    | 0.5  | —    | 0.5  | ns    |
| SSTL2_II_out          | Using SSTL 2.5V, Class II                            | t <sub>IOBUF</sub> , t <sub>IOEN</sub> , t <sub>IODIS</sub> | —               | 0.5  | —    | 0.5  | —    | 0.5  | ns    |
| SSTL3_I_out           | Using SSTL 3.3V, Class I                             | t <sub>IOBUF</sub> , t <sub>IOEN</sub> , t <sub>IODIS</sub> | —               | 0.5  | —    | 0.5  | —    | 0.5  | ns    |
| SSTL3_II_out          | Using SSTL 3.3V, Class II                            | t <sub>IOBUF</sub> , t <sub>IOEN</sub> , t <sub>IODIS</sub> | —               | 0.5  | —    | 0.5  | —    | 0.5  | ns    |

1. Only available for ispXPGA 200B and ispXPGA 200EB (2.5V/3.3V) devices.

Timing v.0.3

**ispXPGA 500B/C & ispXPGA 500EB/EC External Switching Characteristics**  
**Over Recommended Operating Conditions**

| Parameter              | Description                  | Conditions                                                     | -5 <sup>1</sup> |      | -4   |      | -3   |      | Units |
|------------------------|------------------------------|----------------------------------------------------------------|-----------------|------|------|------|------|------|-------|
|                        |                              |                                                                | Min.            | Max. | Min. | Max. | Min. | Max. |       |
| t <sub>CO</sub>        | Global Clock Input to Output | PIO Output Register                                            | —               | 6.4  | —    | 6.9  | —    | 7.9  | ns    |
| t <sub>S</sub>         | Global Clock Input Setup     | PIO Input Register without input delay                         | -2.9            | —    | -2.7 | —    | -2.3 | —    | ns    |
| t <sub>H</sub>         | Global Clock Input Hold      | PIO Input Register without input delay                         | 3.6             | —    | 3.9  | —    | 4.5  | —    | ns    |
| t <sub>SINDLY</sub>    | Global Clock Input Setup     | PIO Input Register with input delay                            | 3.3             | —    | 3.6  | —    | 4.1  | —    | ns    |
| t <sub>HINDLY</sub>    | Global Clock Input Hold      | PIO Input Register with input delay                            | 0.0             | —    | 0.0  | —    | 0.0  | —    |       |
| t <sub>COPLL</sub>     | Global Clock Input to Output | PIO Output Register using PLL without delay                    | —               | 3.2  | —    | 3.4  | —    | 3.9  | ns    |
| t <sub>SPLL</sub>      | Global Clock Input Setup     | PIO Input Register without input delay using PLL without delay | 0.1             | —    | 0.2  | —    | 0.3  | —    | ns    |
| t <sub>HPLL</sub>      | Global Clock Input Hold      | PIO Input Register without input delay using PLL without delay | 0.8             | —    | 0.9  | —    | 1.0  | —    | ns    |
| t <sub>SINDLYPLL</sub> | Global Clock Input Setup     | PIO Input Register with input delay using PLL without delay    | 6.7             | —    | 7.2  | —    | 8.3  | —    | ns    |
| t <sub>HINDLYPLL</sub> | Global Clock Input Hold      | PIO Input Register with input delay using PLL without delay    | -4.3            | —    | -4.0 | —    | -3.4 | —    | ns    |

1. Only available for ispXPGA 500B and ispXPGA 500EB (2.5V/3.3V) devices.

Timing v.0.3

SELECTED  
DISCONTINUED

## ispXPGA 500B/C &amp; ispXPGA 500EB/EC PFU Timing Parameters

Over Recommended Operating Conditions

| Parameter                        | Description                                             | -5 <sup>1</sup> |      | -4    |      | -3    |      | Units |
|----------------------------------|---------------------------------------------------------|-----------------|------|-------|------|-------|------|-------|
|                                  |                                                         | Min.            | Max. | Min.  | Max. | Min.  | Max. |       |
| <b>Functional Delays</b>         |                                                         |                 |      |       |      |       |      |       |
| <b>LUTs</b>                      |                                                         |                 |      |       |      |       |      |       |
| t <sub>LUT4</sub>                | 4-Input LUT Delay                                       | —               | 0.41 | —     | 0.44 | —     | 0.51 | ns    |
| t <sub>LUT5</sub>                | 5-Input LUT Delay                                       | —               | 0.73 | —     | 0.79 | —     | 0.91 | ns    |
| t <sub>LUT6</sub>                | 6-Input LUT Delay                                       | —               | 0.86 | —     | 0.93 | —     | 1.07 | ns    |
| <b>Shift Register (LUT)</b>      |                                                         |                 |      |       |      |       |      |       |
| t <sub>LSR_S</sub>               | Shift Register Setup Time                               | -0.64           | —    | -0.62 | —    | -0.53 | —    | ns    |
| t <sub>LSR_H</sub>               | Shift Register Hold Time                                | 0.61            | —    | 0.63  | —    | 0.72  | —    | ns    |
| t <sub>LSR_CO</sub>              | Shift Register Clock to Output Delay                    | —               | 0.70 | —     | 0.75 | —     | 0.86 | ns    |
| <b>Arithmetic Functions</b>      |                                                         |                 |      |       |      |       |      |       |
| t <sub>LCTHRUR</sub>             | MC (Macro Cell) Carry In to MC Carry Out Delay (Ripple) | —               | 0.08 | —     | 0.09 | —     | 0.10 | ns    |
| t <sub>LCTHRUL<sup>2</sup></sub> | MC Carry In to MC Carry Out Delay (Look Ahead)          | —               | 0.05 | —     | 0.05 | —     | 0.06 | ns    |
| t <sub>LSTHRU</sub>              | MC Sum In to MC Sum Out Delay                           | —               | 0.42 | —     | 0.45 | —     | 0.52 | ns    |
| t <sub>LSINCOUT</sub>            | MC Sum In to MC Carry Out Delay                         | —               | 0.29 | —     | 0.31 | —     | 0.36 | ns    |
| t <sub>LCINSOUTR</sub>           | MC Carry In to MC Sum Out Delay (Ripple)                | —               | 0.36 | —     | 0.39 | —     | 0.45 | ns    |
| t <sub>LCINSOUTL</sub>           | MC Carry In to MC Sum Out Delay (Look Ahead)            | —               | 0.26 | —     | 0.28 | —     | 0.32 | ns    |
| <b>Feed-thru</b>                 |                                                         |                 |      |       |      |       |      |       |
| t <sub>LFT</sub>                 | PFU Feed-Thru Delay                                     | —               | 0.15 | —     | 0.16 | —     | 0.18 | ns    |
| <b>Distributed RAM</b>           |                                                         |                 |      |       |      |       |      |       |
| t <sub>LRAM_CO</sub>             | Clock to RAM Output                                     | —               | 1.24 | —     | 1.33 | —     | 1.53 | ns    |
| t <sub>LRAMAD_S</sub>            | Address Setup Time                                      | -0.41           | —    | -0.40 | —    | -0.34 | —    | ns    |
| t <sub>LRAMD_S</sub>             | Data Setup Time                                         | 0.21            | —    | 0.22  | —    | 0.25  | —    | ns    |
| t <sub>LRAMWE_S</sub>            | Write Enable Setup Time                                 | 0.45            | —    | 0.46  | —    | 0.53  | —    | ns    |
| t <sub>LRAMAD_H</sub>            | Address Hold Time                                       | 0.58            | —    | 0.60  | —    | 0.69  | —    | ns    |
| t <sub>LRAMD_H</sub>             | Data Hold Time                                          | 0.11            | —    | 0.11  | —    | 0.13  | —    | ns    |
| t <sub>LRAMWE_H</sub>            | Write Enable Hold Time                                  | 0.12            | —    | 0.12  | —    | 0.14  | —    | ns    |
| t <sub>LRAMCPW</sub>             | Clock Pulse Width (High or Low)                         | 2.91            | —    | 3.00  | —    | 3.45  | —    | ns    |
| t <sub>LRAMADO</sub>             | Address to Output Delay                                 | —               | 0.86 | —     | 0.93 | —     | 1.07 | ns    |
| <b>Register/Latch Delays</b>     |                                                         |                 |      |       |      |       |      |       |
| <b>Registers</b>                 |                                                         |                 |      |       |      |       |      |       |
| t <sub>L_CO</sub>                | Register Clock to Output Delay                          | —               | 0.58 | —     | 0.62 | —     | 0.71 | ns    |
| t <sub>L_S</sub>                 | Register Setup Time (Data before Clock)                 | 0.14            | —    | 0.14  | —    | 0.16  | —    | ns    |
| t <sub>L_H</sub>                 | Register Hold Time (Data after Clock)                   | -0.12           | —    | -0.12 | —    | -0.10 | —    | ns    |
| t <sub>LCE_S</sub>               | Register Clock Enable Setup Time                        | -0.11           | —    | -0.11 | —    | -0.09 | —    | ns    |
| t <sub>LCE_H</sub>               | Register Clock Enable Hold Time                         | 0.11            | —    | 0.11  | —    | 0.13  | —    | ns    |
| <b>Latches</b>                   |                                                         |                 |      |       |      |       |      |       |
| t <sub>L_GO</sub>                | Latch Gate to Output Delay                              | —               | 0.09 | —     | 0.10 | —     | 0.12 | ns    |
| t <sub>LL_S</sub>                | Latch Setup Time                                        | 0.14            | —    | 0.14  | —    | 0.16  | —    | ns    |
| t <sub>LL_H</sub>                | Latch Hold Time                                         | -0.12           | —    | -0.12 | —    | -0.10 | —    | ns    |
| t <sub>LLPD</sub>                | Latch Propagation Delay (Transparent Mode)              | —               | 0.09 | —     | 0.10 | —     | 0.12 | ns    |

## ispXPGA 500B/C &amp; ispXPGA 500EB/EC PFU Timing Parameters (Cont.)

Over Recommended Operating Conditions

| Parameter            | Description                        | -5 <sup>1</sup> |      | -4    |      | -3    |      | Units |
|----------------------|------------------------------------|-----------------|------|-------|------|-------|------|-------|
|                      |                                    | Min.            | Max. | Min.  | Max. | Min.  | Max. |       |
| <b>Reset/Set</b>     |                                    |                 |      |       |      |       |      |       |
| t <sub>LASSRO</sub>  | Asynchronous Set/Reset to Output   | —               | 1.09 | —     | 1.17 | —     | 1.35 | ns    |
| t <sub>LASSRPW</sub> | Asynchronous Set/Reset Pulse Width | 4.19            | —    | 4.50  | —    | 5.18  | —    | ns    |
| t <sub>LASSRR</sub>  | Asynchronous Set/Reset Recovery    | —               | 0.51 | —     | 0.55 | —     | 0.63 | ns    |
| t <sub>LSSR_S</sub>  | Synchronous Set/Reset Setup Time   | -0.03           | —    | -0.03 | —    | -0.03 | —    | ns    |
| t <sub>LSSR_H</sub>  | Synchronous Set/Reset Hold Time    | 0.03            | —    | 0.03  | —    | 0.03  | —    | ns    |

1. Only available for ispXPGA 500B and ispXPGA 500EB (2.5V/3.3V) devices.

Timing v.0.3

2. t<sub>LCTHRUL</sub> quoted bit by bit.

## ispXPGA 500B/C &amp; ispXPGA 500EB/EC PIC Timing Parameters

| Parameter                    | Description                                | -5 <sup>1</sup> |       | -4    |       | -3    |       | Units |
|------------------------------|--------------------------------------------|-----------------|-------|-------|-------|-------|-------|-------|
|                              |                                            | Min.            | Max.  | Min.  | Max.  | Min.  | Max.  |       |
| <b>Register/Latch Delays</b> |                                            |                 |       |       |       |       |       |       |
| t <sub>IO_CO</sub>           | Register Clock to Output Delay             | —               | 1.00  | —     | 1.07  | —     | 1.23  | ns    |
| t <sub>IO_S</sub>            | Register Setup Time (Data before Clock)    | 0.05            | —     | 0.05  | —     | 0.06  | —     | ns    |
| t <sub>IO_H</sub>            | Register Hold Time (Data after Clock)      | 0.06            | —     | 0.06  | —     | 0.07  | —     | ns    |
| t <sub>IOCE_S</sub>          | Register Clock Enable Setup Time           | -0.03           | —     | -0.03 | —     | -0.03 | —     | ns    |
| t <sub>IOCE_H</sub>          | Register Clock Enable Hold Time            | 0.13            | —     | 0.13  | —     | 0.15  | —     | ns    |
| t <sub>IO_GO</sub>           | Latch Gate to Output Delay                 | —               | 0.78  | —     | 0.84  | —     | 0.97  | ns    |
| t <sub>IOL_S</sub>           | Latch Setup Time                           | 0.05            | —     | 0.05  | —     | 0.06  | —     | ns    |
| t <sub>IOL_H</sub>           | Latch Hold Time                            | 0.06            | —     | 0.06  | —     | 0.07  | —     | ns    |
| t <sub>IOLPD</sub>           | Latch Propagation Delay (Transparent Mode) | —               | 0.09  | —     | 0.10  | —     | 0.12  | ns    |
| t <sub>IOASRO</sub>          | Asynchronous Set/Reset to Output           | —               | 1.11  | —     | 1.19  | —     | 1.37  | ns    |
| t <sub>IOASRPW</sub>         | Asynchronous Set/Reset Pulse Width         | 4.19            | —     | 4.50  | —     | 5.18  | —     | ns    |
| t <sub>IOASRR</sub>          | Asynchronous Set/Reset Recovery Time       | —               | 0.23  | —     | 0.25  | —     | 0.29  | ns    |
| <b>Input/Output Delays</b>   |                                            |                 |       |       |       |       |       |       |
| t <sub>IOBUF</sub>           | Output Buffer Delay                        | —               | 0.98  | —     | 1.05  | —     | 1.21  | ns    |
| t <sub>IOIN</sub>            | Input Buffer Delay                         | —               | 0.65  | —     | 0.70  | —     | 0.81  | ns    |
| t <sub>IOEN</sub>            | Output Enable Delay                        | —               | 0.52  | —     | 0.56  | —     | 0.64  | ns    |
| t <sub>IODIS</sub>           | Output Disable Delay                       | —               | -0.12 | —     | -0.11 | —     | -0.09 | ns    |
| t <sub>IOFT</sub>            | Feed-thru Delay                            | —               | 0.19  | —     | 0.20  | —     | 0.23  | ns    |

1. Only available for ispXPGA 500B and ispXPGA 500EB (2.5V/3.3V) devices.

Timing v.0.3

## ispXPGA 500B/C &amp; ispXPGA 500EB/EC EBR Timing Parameters

| Parameter                | Description                          | -5 <sup>1</sup> |      | -4    |      | -3    |      | Units |
|--------------------------|--------------------------------------|-----------------|------|-------|------|-------|------|-------|
|                          |                                      | Min.            | Max. | Min.  | Max. | Min.  | Max. |       |
| <b>Synchronous Write</b> |                                      |                 |      |       |      |       |      |       |
| t <sub>EBSWAD_S</sub>    | Address Setup Delay                  | 0.59            | —    | 0.61  | —    | 0.70  | —    | ns    |
| t <sub>EBSWAD_H</sub>    | Address Hold Delay                   | -0.40           | —    | -0.39 | —    | -0.33 | —    | ns    |
| t <sub>EBSWCPW</sub>     | Clock Pulse Width                    | 3.16            | —    | 3.40  | —    | 3.91  | —    | ns    |
| t <sub>EBSWWE_S</sub>    | Write Enable Setup Time              | -0.12           | —    | -0.12 | —    | -0.10 | —    | ns    |
| t <sub>EBSWWE_H</sub>    | Write Enable Hold Time               | 0.16            | —    | 0.16  | —    | 0.18  | —    | ns    |
| t <sub>EBSWD_S</sub>     | Data Setup Time                      | 0.27            | —    | 0.28  | —    | 0.32  | —    | ns    |
| t <sub>EBSWD_H</sub>     | Data Hold Time                       | -0.27           | —    | -0.26 | —    | -0.22 | —    | ns    |
| <b>Synchronous Read</b>  |                                      |                 |      |       |      |       |      |       |
| t <sub>EBSR_CO</sub>     | Clock to Data Delay                  | —               | 2.04 | —     | 2.19 | —     | 2.52 | ns    |
| t <sub>EBSRAD_S</sub>    | Address Setup Delay                  | 0.10            | —    | 0.10  | —    | 0.12  | —    | ns    |
| t <sub>EBSRAD_H</sub>    | Address Hold Delay                   | -0.07           | —    | -0.07 | —    | -0.06 | —    | ns    |
| t <sub>EBSRCPW</sub>     | Clock Pulse Width                    | 3.16            | —    | 3.40  | —    | 3.91  | —    | ns    |
| t <sub>EBSRCE_S</sub>    | Clock Enable Setup Time              | -1.76           | —    | -1.71 | —    | -1.45 | —    | ns    |
| t <sub>EBSRCE_H</sub>    | Clock Enable Hold Time               | 1.64            | —    | 1.69  | —    | 1.94  | —    | ns    |
| t <sub>EBSRWE_S</sub>    | Write Enable Setup Time              | -0.18           | —    | -0.17 | —    | -0.14 | —    | ns    |
| t <sub>EBSRWE_H</sub>    | Write Enable Hold Time               | 0.12            | —    | 0.12  | —    | 0.14  | —    | ns    |
| t <sub>EBSRWEEN</sub>    | Write Enable to Data Enable Time     | —               | 1.02 | —     | 1.05 | —     | 1.21 | ns    |
| t <sub>EBSRWEDIS</sub>   | Write Enable to Data Disable Time    | —               | 0.99 | —     | 1.02 | —     | 1.17 | ns    |
| t <sub>EBSREN</sub>      | Output Enable to Data Enable Time    | —               | 1.02 | —     | 1.05 | —     | 1.21 | ns    |
| t <sub>EBSRDIS</sub>     | Output Enable to Data Disable Time   | —               | 0.83 | —     | 0.86 | —     | 0.99 | ns    |
| <b>Asynchronous Read</b> |                                      |                 |      |       |      |       |      |       |
| t <sub>EBARADO</sub>     | Address to New Valid Data Delay      | —               | 2.39 | —     | 2.46 | —     | 2.83 | ns    |
| t <sub>EBARAD_H</sub>    | Address to Previous Valid Data Delay | —               | 2.10 | —     | 2.17 | —     | 2.50 | ns    |
| t <sub>EBARWEEN</sub>    | Write Enable to Data Enable Time     | —               | 1.01 | —     | 1.04 | —     | 1.20 | ns    |
| t <sub>EBARWEDIS</sub>   | Write Enable to Data Disable Time    | —               | 0.98 | —     | 1.01 | —     | 1.16 | ns    |
| t <sub>EBAREN</sub>      | Output Enable to Data Enable Time    | —               | 1.02 | —     | 1.05 | —     | 1.21 | ns    |
| t <sub>EBARDIS</sub>     | Output Enable to Data Disable Time   | —               | 0.83 | —     | 0.86 | —     | 0.99 | ns    |

1. Only available for ispXPGA 500B and ispXPGA 500EB (2.5V/3.3V) devices.

Timing v.0.3

**ispXPGA 500B/C & ispXPGA 500EB/EC Timing Adders**

| Parameter                               | Description                                          | Base Parameter                                              | -5 <sup>1</sup> |      | -4   |      | -3   |      | Units |
|-----------------------------------------|------------------------------------------------------|-------------------------------------------------------------|-----------------|------|------|------|------|------|-------|
|                                         |                                                      |                                                             | Min.            | Max. | Min. | Max. | Min. | Max. |       |
| <b>Optional Adders</b>                  |                                                      |                                                             |                 |      |      |      |      |      |       |
| t <sub>IOINDLY</sub>                    | Input Delay                                          | —                                                           | —               | 5.21 | —    | 5.60 | —    | 6.44 | ns    |
| <b>t<sub>IOI</sub> Input Adjusters</b>  |                                                      |                                                             |                 |      |      |      |      |      |       |
| LVTTTL_in                               | Using 3.3V TTL                                       | t <sub>IOIN</sub>                                           | —               | 0.5  | —    | 0.5  | —    | 0.5  | ns    |
| LVC MOS_18_in                           | Using 1.8V CMOS                                      | t <sub>IOIN</sub>                                           | —               | 0.0  | —    | 0.0  | —    | 0.0  | ns    |
| LVC MOS_25_in                           | Using 2.5V CMOS                                      | t <sub>IOIN</sub>                                           | —               | 0.3  | —    | 0.3  | —    | 0.3  | ns    |
| LVC MOS_33_in                           | Using 3.3V CMOS                                      | t <sub>IOIN</sub>                                           | —               | 0.5  | —    | 0.5  | —    | 0.5  | ns    |
| AGP_1X_in                               | Using AGP 1x                                         | t <sub>IOIN</sub>                                           | —               | 1.0  | —    | 1.0  | —    | 1.0  | ns    |
| CTT25_in                                | Using CTT 2.5V                                       | t <sub>IOIN</sub>                                           | —               | 1.0  | —    | 1.0  | —    | 1.0  | ns    |
| CTT33_in                                | Using CTT 3.3V                                       | t <sub>IOIN</sub>                                           | —               | 1.0  | —    | 1.0  | —    | 1.0  | ns    |
| GTL+_in                                 | Using GTL+                                           | t <sub>IOIN</sub>                                           | —               | 0.5  | —    | 0.5  | —    | 0.5  | ns    |
| HSTL_I_in                               | Using HSTL 2.5V, Class I                             | t <sub>IOIN</sub>                                           | —               | 0.5  | —    | 0.5  | —    | 0.5  | ns    |
| HSTL_III_in                             | Using HSTL 2.5V, Class III                           | t <sub>IOIN</sub>                                           | —               | 0.5  | —    | 0.5  | —    | 0.5  | ns    |
| LVDS_in                                 | Using Low Voltage Differential Signaling (LVDS)      | t <sub>IOIN</sub>                                           | —               | 0.8  | —    | 0.8  | —    | 0.8  | ns    |
| BLVDS_in                                | Using Bus Low Voltage Differential Signaling (BLVDS) | t <sub>IOIN</sub>                                           | —               | 0.8  | —    | 0.8  | —    | 0.8  | ns    |
| LVPECL_in                               | Using Low Voltage PECL                               | t <sub>IOIN</sub>                                           | —               | 0.8  | —    | 0.8  | —    | 0.8  | ns    |
| PCI_in                                  | Using PCI                                            | t <sub>IOIN</sub>                                           | —               | 1.0  | —    | 1.0  | —    | 1.0  | ns    |
| SSTL2_I_in                              | Using SSTL 2.5V, Class I                             | t <sub>IOIN</sub>                                           | —               | 0.8  | —    | 0.8  | —    | 0.8  | ns    |
| SSTL2_II_in                             | Using SSTL 2.5V, Class II                            | t <sub>IOIN</sub>                                           | —               | 0.5  | —    | 0.5  | —    | 0.5  | ns    |
| SSTL3_I_in                              | Using SSTL 3.3V, Class I                             | t <sub>IOIN</sub>                                           | —               | 0.8  | —    | 0.8  | —    | 0.8  | ns    |
| SSTL3_II_in                             | Using SSTL 3.3V, Class II                            | t <sub>IOIN</sub>                                           | —               | 0.8  | —    | 0.8  | —    | 0.8  | ns    |
| <b>t<sub>IOO</sub> Output Adjusters</b> |                                                      |                                                             |                 |      |      |      |      |      |       |
| Slow Slew                               | Using Slow Slew (LVTTTL and LVC MOS Outputs only)    | t <sub>IOBUF</sub> , t <sub>IOEN</sub>                      | —               | 0.7  | —    | 0.7  | —    | 0.7  | ns    |
| LVTTTL_out                              | Using 3.3V TTL Drive                                 | t <sub>IOBUF</sub> , t <sub>IOEN</sub> , t <sub>IODIS</sub> | —               | 1.0  | —    | 1.0  | —    | 1.0  | ns    |
| LVC MOS_18_4mA_out                      | Using 1.8V CMOS Standard, 4mA Drive                  | t <sub>IOBUF</sub> , t <sub>IOEN</sub> , t <sub>IODIS</sub> | —               | 0.8  | —    | 0.8  | —    | 0.8  | ns    |
| LVC MOS_18_5.33mA_out                   | Using 1.8V CMOS Standard, 5.33mA Drive               | t <sub>IOBUF</sub> , t <sub>IOEN</sub> , t <sub>IODIS</sub> | —               | 0.6  | —    | 0.6  | —    | 0.6  | ns    |
| LVC MOS_18_8mA_out                      | Using 1.8V CMOS Standard, 8mA Drive                  | t <sub>IOBUF</sub> , t <sub>IOEN</sub> , t <sub>IODIS</sub> | —               | 0.0  | —    | 0.0  | —    | 0.0  | ns    |
| LVC MOS_18_12mA_out                     | Using 1.8V CMOS Standard, 12mA Drive                 | t <sub>IOBUF</sub> , t <sub>IOEN</sub> , t <sub>IODIS</sub> | —               | 0.2  | —    | 0.2  | —    | 0.2  | ns    |
| LVC MOS_25_4mA_out                      | Using 2.5V CMOS Standard, 4mA Drive                  | t <sub>IOBUF</sub> , t <sub>IOEN</sub> , t <sub>IODIS</sub> | —               | 0.7  | —    | 0.7  | —    | 0.7  | ns    |
| LVC MOS_25_5.33mA_out                   | Using 2.5V CMOS Standard, 5.33 mA Drive              | t <sub>IOBUF</sub> , t <sub>IOEN</sub> , t <sub>IODIS</sub> | —               | 0.5  | —    | 0.5  | —    | 0.5  | ns    |
| LVC MOS_25_8mA_out                      | Using 2.5V CMOS Standard, 8mA Drive                  | t <sub>IOBUF</sub> , t <sub>IOEN</sub> , t <sub>IODIS</sub> | —               | 0.5  | —    | 0.5  | —    | 0.5  | ns    |
| LVC MOS_25_12mA_out                     | Using 2.5V CMOS Standard, 12mA Drive                 | t <sub>IOBUF</sub> , t <sub>IOEN</sub> , t <sub>IODIS</sub> | —               | 0.5  | —    | 0.5  | —    | 0.5  | ns    |
| LVC MOS_25_16mA_out                     | Using 2.5V CMOS Standard, 16mA Drive                 | t <sub>IOBUF</sub> , t <sub>IOEN</sub> , t <sub>IODIS</sub> | —               | 0.5  | —    | 0.5  | —    | 0.5  | ns    |

## ispXPGA 500B/C &amp; ispXPGA 500EB/EC Timing Adders (Cont.)

| Parameter             | Description                                          | Base Parameter                                              | -5 <sup>1</sup> |      | -4   |      | -3   |      | Units |
|-----------------------|------------------------------------------------------|-------------------------------------------------------------|-----------------|------|------|------|------|------|-------|
|                       |                                                      |                                                             | Min.            | Max. | Min. | Max. | Min. | Max. |       |
| LVC MOS_33_4mA_out    | Using 3.3V CMOS Standard, 4mA Drive                  | t <sub>IOBUF</sub> , t <sub>IOEN</sub> , t <sub>IODIS</sub> | —               | 1.0  | —    | 1.0  | —    | 1.0  | ns    |
| LVC MOS_33_5.33mA_out | Using 3.3V CMOS Standard, 5.33mA Drive               | t <sub>IOBUF</sub> , t <sub>IOEN</sub> , t <sub>IODIS</sub> | —               | 1.0  | —    | 1.0  | —    | 1.0  | ns    |
| LVC MOS_33_8mA_out    | Using 3.3V CMOS Standard, 8mA Drive                  | t <sub>IOBUF</sub> , t <sub>IOEN</sub> , t <sub>IODIS</sub> | —               | 0.7  | —    | 0.7  | —    | 0.7  | ns    |
| LVC MOS_33_12mA_out   | Using 3.3V CMOS Standard, 12mA Drive                 | t <sub>IOBUF</sub> , t <sub>IOEN</sub> , t <sub>IODIS</sub> | —               | 0.5  | —    | 0.5  | —    | 0.5  | ns    |
| LVC MOS_33_16mA_out   | Using 3.3V CMOS Standard, 16mA Drive                 | t <sub>IOBUF</sub> , t <sub>IOEN</sub> , t <sub>IODIS</sub> | —               | 0.5  | —    | 0.5  | —    | 0.5  | ns    |
| LVC MOS_33_24mA_out   | Using 3.3V CMOS Standard, 24mA Drive                 | t <sub>IOBUF</sub> , t <sub>IOEN</sub> , t <sub>IODIS</sub> | —               | 0.5  | —    | 0.5  | —    | 0.5  | ns    |
| AGP_1X_out            | Using AGP 1x Standard                                | t <sub>IOBUF</sub> , t <sub>IOEN</sub> , t <sub>IODIS</sub> | —               | 0.5  | —    | 0.5  | —    | 0.5  | ns    |
| CTT25_out             | Using CTT 2.5V                                       | t <sub>IOBUF</sub> , t <sub>IOEN</sub> , t <sub>IODIS</sub> | —               | 0.5  | —    | 0.5  | —    | 0.5  | ns    |
| CTT33_out             | Using CTT 3.3V                                       | t <sub>IOBUF</sub> , t <sub>IOEN</sub> , t <sub>IODIS</sub> | —               | 0.5  | —    | 0.5  | —    | 0.5  | ns    |
| GTL+_out              | Using GTL+                                           | t <sub>IOBUF</sub> , t <sub>IOEN</sub> , t <sub>IODIS</sub> | —               | 0.5  | —    | 0.5  | —    | 0.5  | ns    |
| HSTL_I_out            | Using HSTL 2.5V, Class I                             | t <sub>IOBUF</sub> , t <sub>IOEN</sub> , t <sub>IODIS</sub> | —               | 0.5  | —    | 0.5  | —    | 0.5  | ns    |
| HSTL_III_out          | Using HSTL 2.5V, Class III                           | t <sub>IOBUF</sub> , t <sub>IOEN</sub> , t <sub>IODIS</sub> | —               | 0.5  | —    | 0.5  | —    | 0.5  | ns    |
| LVDS_out              | Using Low Voltage Differential Signaling (LVDS)      | t <sub>IOBUF</sub> , t <sub>IOEN</sub> , t <sub>IODIS</sub> | —               | 1.0  | —    | 1.0  | —    | 1.0  | ns    |
| BLVDS_out             | Using Bus Low Voltage Differential Signaling (BLVDS) | t <sub>IOBUF</sub> , t <sub>IOEN</sub> , t <sub>IODIS</sub> | —               | 1.0  | —    | 1.0  | —    | 1.0  | ns    |
| LVPECL_out            | Using Low Voltage PECL                               | t <sub>IOBUF</sub> , t <sub>IOEN</sub> , t <sub>IODIS</sub> | —               | 1.0  | —    | 1.0  | —    | 1.0  | ns    |
| PCI_out               | Using PCI Standard                                   | t <sub>IOBUF</sub> , t <sub>IOEN</sub> , t <sub>IODIS</sub> | —               | 0.5  | —    | 0.5  | —    | 0.5  | ns    |
| SSTL2_I_out           | Using SSTL 2.5V, Class I                             | t <sub>IOBUF</sub> , t <sub>IOEN</sub> , t <sub>IODIS</sub> | —               | 0.5  | —    | 0.5  | —    | 0.5  | ns    |
| SSTL2_II_out          | Using SSTL 2.5V, Class II                            | t <sub>IOBUF</sub> , t <sub>IOEN</sub> , t <sub>IODIS</sub> | —               | 0.5  | —    | 0.5  | —    | 0.5  | ns    |
| SSTL3_I_out           | Using SSTL 3.3V, Class I                             | t <sub>IOBUF</sub> , t <sub>IOEN</sub> , t <sub>IODIS</sub> | —               | 0.5  | —    | 0.5  | —    | 0.5  | ns    |
| SSTL3_II_out          | Using SSTL 3.3V, Class II                            | t <sub>IOBUF</sub> , t <sub>IOEN</sub> , t <sub>IODIS</sub> | —               | 0.5  | —    | 0.5  | —    | 0.5  | ns    |

1. Only available for ispXPGA 500B and ispXPGA 500EB (2.5V/3.3V) devices.

Timing v.0.3



**ispXPGA 1200B/C & ispXPGA 1200EB/EC External Switching Characteristics**

Over Recommended Operating Conditions

| Parameter              | Description                  | Conditions                                                     | -5 <sup>1</sup> |      | -4   |      | -3   |      | Units |
|------------------------|------------------------------|----------------------------------------------------------------|-----------------|------|------|------|------|------|-------|
|                        |                              |                                                                | Min.            | Max. | Min. | Max. | Min. | Max. |       |
| t <sub>CO</sub>        | Global Clock Input to Output | PIO Output Register                                            | —               | 6.6  | —    | 7.1  | —    | 8.2  | ns    |
| t <sub>S</sub>         | Global Clock Input Setup     | PIO Input Register without input delay                         | -2.7            | —    | -2.7 | —    | -2.3 | —    | ns    |
| t <sub>H</sub>         | Global Clock Input Hold      | PIO Input Register without input delay                         | 4.5             | —    | 4.6  | —    | 5.3  | —    | ns    |
| t <sub>SINDLY</sub>    | Global Clock Input Setup     | PIO Input Register with input delay                            | 3.8             | —    | 3.8  | —    | 4.4  | —    | ns    |
| t <sub>HINDLY</sub>    | Global Clock Input Hold      | PIO Input Register with input delay                            | 0.0             | —    | 0.0  | —    | 0.0  | —    |       |
| t <sub>COPLL</sub>     | Global Clock Input to Output | PIO Output Register using PLL without delay                    | —               | 3.1  | —    | 3.3  | —    | 3.8  | ns    |
| t <sub>SPLL</sub>      | Global Clock Input Setup     | PIO Input Register without input delay using PLL without delay | 0.5             | —    | 0.5  | —    | 0.6  | —    | ns    |
| t <sub>HPLL</sub>      | Global Clock Input Hold      | PIO Input Register without input delay using PLL without delay | 0.8             | —    | 0.8  | —    | 1.0  | —    | ns    |
| t <sub>SINDLYPLL</sub> | Global Clock Input Setup     | PIO Input Register with input delay using PLL without delay    | 7.6             | —    | 7.6  | —    | 8.8  | —    | ns    |
| t <sub>HINDLYPLL</sub> | Global Clock Input Hold      | PIO Input Register with input delay using PLL without delay    | -4.1            | —    | -4.0 | —    | -3.4 | —    | ns    |

1. Only available for ispXPGA 1200B and ispXPGA 1200EB (2.5V/3.3V) devices.

Timing v.0.2



## ispXPGA 1200B/C &amp; ispXPGA 1200EB/EC PFU Timing Parameters

Over Recommended Operating Conditions

| Parameter                        | Description                                             | -5 <sup>1</sup> |      | -4    |      | -3    |      | Units |
|----------------------------------|---------------------------------------------------------|-----------------|------|-------|------|-------|------|-------|
|                                  |                                                         | Min.            | Max. | Min.  | Max. | Min.  | Max. |       |
| <b>Functional Delays</b>         |                                                         |                 |      |       |      |       |      |       |
| <b>LUTs</b>                      |                                                         |                 |      |       |      |       |      |       |
| t <sub>LUT4</sub>                | 4-Input LUT Delay                                       | —               | 0.41 | —     | 0.44 | —     | 0.51 | ns    |
| t <sub>LUT5</sub>                | 5-Input LUT Delay                                       | —               | 0.73 | —     | 0.79 | —     | 0.91 | ns    |
| t <sub>LUT6</sub>                | 6-Input LUT Delay                                       | —               | 0.86 | —     | 0.93 | —     | 1.07 | ns    |
| <b>Shift Register (LUT)</b>      |                                                         |                 |      |       |      |       |      |       |
| t <sub>LSR_S</sub>               | Shift Register Setup Time                               | -0.64           | —    | -0.62 | —    | -0.53 | —    | ns    |
| t <sub>LSR_H</sub>               | Shift Register Hold Time                                | 0.61            | —    | 0.63  | —    | 0.72  | —    | ns    |
| t <sub>LSR_CO</sub>              | Shift Register Clock to Output Delay                    | —               | 0.70 | —     | 0.75 | —     | 0.86 | ns    |
| <b>Arithmetic Functions</b>      |                                                         |                 |      |       |      |       |      |       |
| t <sub>LCTHRUR</sub>             | MC (Macro Cell) Carry In to MC Carry Out Delay (Ripple) | —               | 0.08 | —     | 0.09 | —     | 0.10 | ns    |
| t <sub>LCTHRUL<sup>2</sup></sub> | MC Carry In to MC Carry Out Delay (Look Ahead)          | —               | 0.05 | —     | 0.05 | —     | 0.06 | ns    |
| t <sub>LSTHRU</sub>              | MC Sum In to MC Sum Out Delay                           | —               | 0.42 | —     | 0.45 | —     | 0.52 | ns    |
| t <sub>LSINCOUT</sub>            | MC Sum In to MC Carry Out Delay                         | —               | 0.29 | —     | 0.31 | —     | 0.36 | ns    |
| t <sub>LCINSOUTR</sub>           | MC Carry In to MC Sum Out Delay (Ripple)                | —               | 0.36 | —     | 0.39 | —     | 0.45 | ns    |
| t <sub>LCINSOUTL</sub>           | MC Carry In to MC Sum Out Delay (Look Ahead)            | —               | 0.26 | —     | 0.28 | —     | 0.32 | ns    |
| <b>Feed-thru</b>                 |                                                         |                 |      |       |      |       |      |       |
| t <sub>LFT</sub>                 | PFU Feed-Thru Delay                                     | —               | 0.15 | —     | 0.16 | —     | 0.18 | ns    |
| <b>Distributed RAM</b>           |                                                         |                 |      |       |      |       |      |       |
| t <sub>LRAM_CO</sub>             | Clock to RAM Output                                     | —               | 1.24 | —     | 1.33 | —     | 1.53 | ns    |
| t <sub>LRAMAD_S</sub>            | Address Setup Time                                      | -0.41           | —    | -0.40 | —    | -0.34 | —    | ns    |
| t <sub>LRAMD_S</sub>             | Data Setup Time                                         | 0.21            | —    | 0.22  | —    | 0.25  | —    | ns    |
| t <sub>LRAMWE_S</sub>            | Write Enable Setup Time                                 | 0.45            | —    | 0.46  | —    | 0.53  | —    | ns    |
| t <sub>LRAMAD_H</sub>            | Address Hold Time                                       | 0.58            | —    | 0.60  | —    | 0.69  | —    | ns    |
| t <sub>LRAMD_H</sub>             | Data Hold Time                                          | 0.11            | —    | 0.11  | —    | 0.13  | —    | ns    |
| t <sub>LRAMWE_H</sub>            | Write Enable Hold Time                                  | 0.12            | —    | 0.12  | —    | 0.14  | —    | ns    |
| t <sub>LRAMCPW</sub>             | Clock Pulse Width (High or Low)                         | 2.91            | —    | 3.00  | —    | 3.45  | —    | ns    |
| t <sub>LRAMADO</sub>             | Address to Output Delay                                 | —               | 0.86 | —     | 0.93 | —     | 1.07 | ns    |
| <b>Register/Latch Delays</b>     |                                                         |                 |      |       |      |       |      |       |
| <b>Registers</b>                 |                                                         |                 |      |       |      |       |      |       |
| t <sub>L_CO</sub>                | Register Clock to Output Delay                          | —               | 0.58 | —     | 0.62 | —     | 0.71 | ns    |
| t <sub>L_S</sub>                 | Register Setup Time (Data before Clock)                 | 0.14            | —    | 0.14  | —    | 0.16  | —    | ns    |
| t <sub>L_H</sub>                 | Register Hold Time (Data after Clock)                   | -0.12           | —    | -0.12 | —    | -0.10 | —    | ns    |
| t <sub>LCE_S</sub>               | Register Clock Enable Setup Time                        | -0.11           | —    | -0.11 | —    | -0.09 | —    | ns    |
| t <sub>LCE_H</sub>               | Register Clock Enable Hold Time                         | 0.11            | —    | 0.11  | —    | 0.13  | —    | ns    |
| <b>Latches</b>                   |                                                         |                 |      |       |      |       |      |       |
| t <sub>L_GO</sub>                | Latch Gate to Output Delay                              | —               | 0.09 | —     | 0.10 | —     | 0.12 | ns    |
| t <sub>LL_S</sub>                | Latch Setup Time                                        | 0.14            | —    | 0.14  | —    | 0.16  | —    | ns    |
| t <sub>LL_H</sub>                | Latch Hold Time                                         | -0.12           | —    | -0.12 | —    | -0.10 | —    | ns    |
| t <sub>LLPD</sub>                | Latch Propagation Delay (Transparent Mode)              | —               | 0.09 | —     | 0.10 | —     | 0.12 | ns    |

## ispXPGA 1200B/C &amp; ispXPGA 1200EB/EC PFU Timing Parameters (Cont.)

Over Recommended Operating Conditions

| Parameter            | Description                        | -5 <sup>1</sup> |      | -4    |      | -3    |      | Units |
|----------------------|------------------------------------|-----------------|------|-------|------|-------|------|-------|
|                      |                                    | Min.            | Max. | Min.  | Max. | Min.  | Max. |       |
| <b>Reset/Set</b>     |                                    |                 |      |       |      |       |      |       |
| t <sub>LASSRO</sub>  | Asynchronous Set/Reset to Output   | —               | 1.09 | —     | 1.17 | —     | 1.35 | ns    |
| t <sub>LASSRPW</sub> | Asynchronous Set/Reset Pulse Width | 4.19            | —    | 4.50  | —    | 5.18  | —    | ns    |
| t <sub>LASSRR</sub>  | Asynchronous Set/Reset Recovery    | —               | 0.51 | —     | 0.55 | —     | 0.63 | ns    |
| t <sub>LSSR_S</sub>  | Synchronous Set/Reset Setup Time   | -0.03           | —    | -0.03 | —    | -0.03 | —    | ns    |
| t <sub>LSSR_H</sub>  | Synchronous Set/Reset Hold Time    | 0.03            | —    | 0.03  | —    | 0.03  | —    | ns    |

1. Only available for ispXPGA 1200B and ispXPGA 1200EB (2.5V/3.3V) devices.

Timing v.2.1

2. t<sub>LCTHRUL</sub> quoted bit by bit.

## ispXPGA 1200B/C &amp; ispXPGA 1200EB/EC PIC Timing Parameters

| Parameter                    | Description                                | -5 <sup>1</sup> |       | -4    |       | -3    |       | Units |
|------------------------------|--------------------------------------------|-----------------|-------|-------|-------|-------|-------|-------|
|                              |                                            | Min.            | Max.  | Min.  | Max.  | Min.  | Max.  |       |
| <b>Register/Latch Delays</b> |                                            |                 |       |       |       |       |       |       |
| t <sub>IO_CO</sub>           | Register Clock to Output Delay             | —               | 1.01  | —     | 1.09  | —     | 1.25  | ns    |
| t <sub>IO_S</sub>            | Register Setup Time (Data before Clock)    | 0.05            | —     | 0.05  | —     | 0.06  | —     | ns    |
| t <sub>IO_H</sub>            | Register Hold Time (Data after Clock)      | 0.06            | —     | 0.06  | —     | 0.07  | —     | ns    |
| t <sub>IOCE_S</sub>          | Register Clock Enable Setup Time           | -0.03           | —     | -0.03 | —     | -0.03 | —     | ns    |
| t <sub>IOCE_H</sub>          | Register Clock Enable Hold Time            | 0.13            | —     | 0.13  | —     | 0.15  | —     | ns    |
| t <sub>IO_GO</sub>           | Latch Gate to Output Delay                 | —               | 0.85  | —     | 0.91  | —     | 1.05  | ns    |
| t <sub>IOL_S</sub>           | Latch Setup Time                           | 0.05            | —     | 0.05  | —     | 0.06  | —     | ns    |
| t <sub>IOL_H</sub>           | Latch Hold Time                            | 0.06            | —     | 0.06  | —     | 0.07  | —     | ns    |
| t <sub>IOLPD</sub>           | Latch Propagation Delay (Transparent Mode) | —               | 0.09  | —     | 0.10  | —     | 0.12  | ns    |
| t <sub>IOASRO</sub>          | Asynchronous Set/Reset to Output           | —               | 1.17  | —     | 1.26  | —     | 1.45  | ns    |
| t <sub>IOASRPW</sub>         | Asynchronous Set/Reset Pulse Width         | 4.19            | —     | 4.50  | —     | 5.18  | —     | ns    |
| t <sub>IOASRR</sub>          | Asynchronous Set/Reset Recovery Time       | —               | 0.23  | —     | 0.25  | —     | 0.29  | ns    |
| <b>Input/Output Delays</b>   |                                            |                 |       |       |       |       |       |       |
| t <sub>IOBUF</sub>           | Output Buffer Delay                        | —               | 0.99  | —     | 1.06  | —     | 1.22  | ns    |
| t <sub>IOIN</sub>            | Input Buffer Delay                         | —               | 0.71  | —     | 0.76  | —     | 0.87  | ns    |
| t <sub>IOEN</sub>            | Output Enable Delay                        | —               | 0.52  | —     | 0.56  | —     | 0.64  | ns    |
| t <sub>IODIS</sub>           | Output Disable Delay                       | —               | -0.11 | —     | -0.10 | —     | -0.09 | ns    |
| t <sub>IOFT</sub>            | Feed-thru Delay                            | —               | 0.19  | —     | 0.20  | —     | 0.23  | ns    |

1. Only available for ispXPGA 1200B and ispXPGA 1200EB (2.5V/3.3V) devices.

Timing v.2.1

**ispXPGA 1200B/C & ispXPGA 1200EB/EC EBR Timing Parameters**

| Parameter                | Description                          | -5 <sup>1</sup> |      | -4    |      | -3    |      | Units |
|--------------------------|--------------------------------------|-----------------|------|-------|------|-------|------|-------|
|                          |                                      | Min.            | Max. | Min.  | Max. | Min.  | Max. |       |
| <b>Synchronous Write</b> |                                      |                 |      |       |      |       |      |       |
| t <sub>EBSWAD_S</sub>    | Address Setup Delay                  | 0.59            | —    | 0.61  | —    | 0.70  | —    | ns    |
| t <sub>EBSWAD_H</sub>    | Address Hold Delay                   | -0.40           | —    | -0.39 | —    | -0.33 | —    | ns    |
| t <sub>EBSWCPW</sub>     | Clock Pulse Width                    | 3.16            | —    | 3.40  | —    | 3.91  | —    | ns    |
| t <sub>EBSWWE_S</sub>    | Write Enable Setup Time              | -0.12           | —    | -0.12 | —    | -0.10 | —    | ns    |
| t <sub>EBSWWE_H</sub>    | Write Enable Hold Time               | 0.16            | —    | 0.16  | —    | 0.18  | —    | ns    |
| t <sub>EBSWD_S</sub>     | Data Setup Time                      | 0.27            | —    | 0.28  | —    | 0.32  | —    | ns    |
| t <sub>EBSWD_H</sub>     | Data Hold Time                       | -0.27           | —    | -0.26 | —    | -0.22 | —    | ns    |
| <b>Synchronous Read</b>  |                                      |                 |      |       |      |       |      |       |
| t <sub>EBSR_CO</sub>     | Clock to Data Delay                  | —               | 2.04 | —     | 2.19 | —     | 2.52 | ns    |
| t <sub>EBSRAD_S</sub>    | Address Setup Delay                  | 0.10            | —    | 0.10  | —    | 0.12  | —    | ns    |
| t <sub>EBSRAD_H</sub>    | Address Hold Delay                   | -0.07           | —    | -0.07 | —    | -0.06 | —    | ns    |
| t <sub>EBSRCPW</sub>     | Clock Pulse Width                    | 3.16            | —    | 3.40  | —    | 3.91  | —    | ns    |
| t <sub>EBSRCE_S</sub>    | Clock Enable Setup Time              | -1.76           | —    | -1.71 | —    | -1.45 | —    | ns    |
| t <sub>EBSRCE_H</sub>    | Clock Enable Hold Time               | 1.64            | —    | 1.69  | —    | 1.94  | —    | ns    |
| t <sub>EBSRWE_S</sub>    | Write Enable Setup Time              | -0.18           | —    | -0.17 | —    | -0.14 | —    | ns    |
| t <sub>EBSRWE_H</sub>    | Write Enable Hold Time               | 0.12            | —    | 0.12  | —    | 0.14  | —    | ns    |
| t <sub>EBSRWEEN</sub>    | Write Enable to Data Enable Time     | —               | 1.02 | —     | 1.05 | —     | 1.21 | ns    |
| t <sub>EBSRWEDIS</sub>   | Write Enable to Data Disable Time    | —               | 0.99 | —     | 1.02 | —     | 1.17 | ns    |
| t <sub>EBSREN</sub>      | Output Enable to Data Enable Time    | —               | 1.02 | —     | 1.05 | —     | 1.21 | ns    |
| t <sub>EBSRDIS</sub>     | Output Enable to Data Disable Time   | —               | 0.83 | —     | 0.86 | —     | 0.99 | ns    |
| <b>Asynchronous Read</b> |                                      |                 |      |       |      |       |      |       |
| t <sub>EBARADO</sub>     | Address to New Valid Data Delay      | —               | 2.39 | —     | 2.46 | —     | 2.83 | ns    |
| t <sub>EBARAD_H</sub>    | Address to Previous Valid Data Delay | —               | 2.10 | —     | 2.17 | —     | 2.50 | ns    |
| t <sub>EBARWEEN</sub>    | Write Enable to Data Enable Time     | —               | 1.01 | —     | 1.04 | —     | 1.20 | ns    |
| t <sub>EBARWEDIS</sub>   | Write Enable to Data Disable Time    | —               | 0.98 | —     | 1.01 | —     | 1.16 | ns    |
| t <sub>EBAREN</sub>      | Output Enable to Data Enable Time    | —               | 1.02 | —     | 1.05 | —     | 1.21 | ns    |
| t <sub>EBARDIS</sub>     | Output Enable to Data Disable Time   | —               | 0.83 | —     | 0.86 | —     | 0.99 | ns    |

1. Only available for ispXPGA 1200B and ispXPGA 1200EB (2.5V/3.3V) devices.

Timing v.2.1

**ispXPGA 1200B/C & ispXPGA 1200EB/EC Timing Adders**

| Parameter                               | Description                                          | Base Parameter                                              | -5 <sup>1</sup> |      | -4   |      | -3   |      | Units |
|-----------------------------------------|------------------------------------------------------|-------------------------------------------------------------|-----------------|------|------|------|------|------|-------|
|                                         |                                                      |                                                             | Min.            | Max. | Min. | Max. | Min. | Max. |       |
| <b>Optional Adders</b>                  |                                                      |                                                             |                 |      |      |      |      |      |       |
| t <sub>IOINDLY</sub>                    | Input Delay                                          | —                                                           | —               | 5.58 | —    | 6.0  | —    | 6.90 | ns    |
| <b>t<sub>IOI</sub> Input Adjusters</b>  |                                                      |                                                             |                 |      |      |      |      |      |       |
| LVTTTL_in                               | Using 3.3V TTL                                       | t <sub>IOIN</sub>                                           | —               | 0.5  | —    | 0.5  | —    | 0.5  | ns    |
| LVC MOS_18_in                           | Using 1.8V CMOS                                      | t <sub>IOIN</sub>                                           | —               | 0.0  | —    | 0.0  | —    | 0.0  | ns    |
| LVC MOS_25_in                           | Using 2.5V CMOS                                      | t <sub>IOIN</sub>                                           | —               | 0.3  | —    | 0.3  | —    | 0.3  | ns    |
| LVC MOS_33_in                           | Using 3.3V CMOS                                      | t <sub>IOIN</sub>                                           | —               | 0.5  | —    | 0.5  | —    | 0.5  | ns    |
| AGP_1X_in                               | Using AGP 1x                                         | t <sub>IOIN</sub>                                           | —               | 1.0  | —    | 1.0  | —    | 1.0  | ns    |
| CTT25_in                                | Using CTT 2.5V                                       | t <sub>IOIN</sub>                                           | —               | 1.0  | —    | 1.0  | —    | 1.0  | ns    |
| CTT33_in                                | Using CTT 3.3V                                       | t <sub>IOIN</sub>                                           | —               | 1.0  | —    | 1.0  | —    | 1.0  | ns    |
| GTL+_in                                 | Using GTL+                                           | t <sub>IOIN</sub>                                           | —               | 0.5  | —    | 0.5  | —    | 0.5  | ns    |
| HSTL_I_in                               | Using HSTL 2.5V, Class I                             | t <sub>IOIN</sub>                                           | —               | 0.5  | —    | 0.5  | —    | 0.5  | ns    |
| HSTL_III_in                             | Using HSTL 2.5V, Class III                           | t <sub>IOIN</sub>                                           | —               | 0.5  | —    | 0.5  | —    | 0.5  | ns    |
| LVDS_in                                 | Using Low Voltage Differential Signaling (LVDS)      | t <sub>IOIN</sub>                                           | —               | 0.8  | —    | 0.8  | —    | 0.8  | ns    |
| BLVDS_in                                | Using Bus Low Voltage Differential Signaling (BLVDS) | t <sub>IOIN</sub>                                           | —               | 0.8  | —    | 0.8  | —    | 0.8  | ns    |
| LVPECL_in                               | Using Low Voltage PECL                               | t <sub>IOIN</sub>                                           | —               | 0.8  | —    | 0.8  | —    | 0.8  | ns    |
| PCI_in                                  | Using PCI                                            | t <sub>IOIN</sub>                                           | —               | 1.0  | —    | 1.0  | —    | 1.0  | ns    |
| SSTL2_I_in                              | Using SSTL 2.5V, Class I                             | t <sub>IOIN</sub>                                           | —               | 0.8  | —    | 0.8  | —    | 0.8  | ns    |
| SSTL2_II_in                             | Using SSTL 2.5V, Class II                            | t <sub>IOIN</sub>                                           | —               | 0.5  | —    | 0.5  | —    | 0.5  | ns    |
| SSTL3_I_in                              | Using SSTL 3.3V, Class I                             | t <sub>IOIN</sub>                                           | —               | 0.8  | —    | 0.8  | —    | 0.8  | ns    |
| SSTL3_II_in                             | Using SSTL 3.3V, Class II                            | t <sub>IOIN</sub>                                           | —               | 0.8  | —    | 0.8  | —    | 0.8  | ns    |
| <b>t<sub>IOO</sub> Output Adjusters</b> |                                                      |                                                             |                 |      |      |      |      |      |       |
| Slow Slew                               | Using Slow Slew (LVTTTL and LVC MOS Outputs only)    | t <sub>IOBUF</sub> , t <sub>IOEN</sub>                      | —               | 0.7  | —    | 0.7  | —    | 0.7  | ns    |
| LVTTTL_out                              | Using 3.3V TTL Drive                                 | t <sub>IOBUF</sub> , t <sub>IOEN</sub> , t <sub>IODIS</sub> | —               | 1.0  | —    | 1.0  | —    | 1.0  | ns    |
| LVC MOS_18_4mA_out                      | Using 1.8V CMOS Standard, 4mA Drive                  | t <sub>IOBUF</sub> , t <sub>IOEN</sub> , t <sub>IODIS</sub> | —               | 0.8  | —    | 0.8  | —    | 0.8  | ns    |
| LVC MOS_18_5.33mA_out                   | Using 1.8V CMOS Standard, 5.33mA Drive               | t <sub>IOBUF</sub> , t <sub>IOEN</sub> , t <sub>IODIS</sub> | —               | 0.6  | —    | 0.6  | —    | 0.6  | ns    |
| LVC MOS_18_8mA_out                      | Using 1.8V CMOS Standard, 8mA Drive                  | t <sub>IOBUF</sub> , t <sub>IOEN</sub> , t <sub>IODIS</sub> | —               | 0.0  | —    | 0.0  | —    | 0.0  | ns    |
| LVC MOS_18_12mA_out                     | Using 1.8V CMOS Standard, 12mA Drive                 | t <sub>IOBUF</sub> , t <sub>IOEN</sub> , t <sub>IODIS</sub> | —               | 0.2  | —    | 0.2  | —    | 0.2  | ns    |
| LVC MOS_25_4mA_out                      | Using 2.5V CMOS Standard, 4mA Drive                  | t <sub>IOBUF</sub> , t <sub>IOEN</sub> , t <sub>IODIS</sub> | —               | 0.7  | —    | 0.7  | —    | 0.7  | ns    |
| LVC MOS_25_5.33mA_out                   | Using 2.5V CMOS Standard, 5.33 mA Drive              | t <sub>IOBUF</sub> , t <sub>IOEN</sub> , t <sub>IODIS</sub> | —               | 0.5  | —    | 0.5  | —    | 0.5  | ns    |
| LVC MOS_25_8mA_out                      | Using 2.5V CMOS Standard, 8mA Drive                  | t <sub>IOBUF</sub> , t <sub>IOEN</sub> , t <sub>IODIS</sub> | —               | 0.5  | —    | 0.5  | —    | 0.5  | ns    |
| LVC MOS_25_12mA_out                     | Using 2.5V CMOS Standard, 12mA Drive                 | t <sub>IOBUF</sub> , t <sub>IOEN</sub> , t <sub>IODIS</sub> | —               | 0.5  | —    | 0.5  | —    | 0.5  | ns    |
| LVC MOS_25_16mA_out                     | Using 2.5V CMOS Standard, 16mA Drive                 | t <sub>IOBUF</sub> , t <sub>IOEN</sub> , t <sub>IODIS</sub> | —               | 0.5  | —    | 0.5  | —    | 0.5  | ns    |

ispXPGA 1200B/C & ispXPGA 1200EB/EC Timing Adders (Cont.)

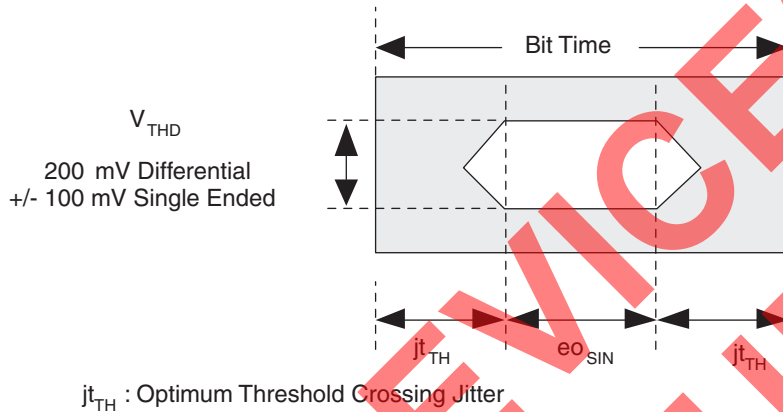
| Parameter             | Description                                          | Base Parameter                                              | -5 <sup>1</sup> |      | -4   |      | -3   |      | Units |
|-----------------------|------------------------------------------------------|-------------------------------------------------------------|-----------------|------|------|------|------|------|-------|
|                       |                                                      |                                                             | Min.            | Max. | Min. | Max. | Min. | Max. |       |
| LVC MOS_33_4mA_out    | Using 3.3V CMOS Standard, 4mA Drive                  | t <sub>IOBUF</sub> , t <sub>IOEN</sub> , t <sub>IODIS</sub> | —               | 1.0  | —    | 1.0  | —    | 1.0  | ns    |
| LVC MOS_33_5.33mA_out | Using 3.3V CMOS Standard, 5.33mA Drive               | t <sub>IOBUF</sub> , t <sub>IOEN</sub> , t <sub>IODIS</sub> | —               | 1.0  | —    | 1.0  | —    | 1.0  | ns    |
| LVC MOS_33_8mA_out    | Using 3.3V CMOS Standard, 8mA Drive                  | t <sub>IOBUF</sub> , t <sub>IOEN</sub> , t <sub>IODIS</sub> | —               | 0.7  | —    | 0.7  | —    | 0.7  | ns    |
| LVC MOS_33_12mA_out   | Using 3.3V CMOS Standard, 12mA Drive                 | t <sub>IOBUF</sub> , t <sub>IOEN</sub> , t <sub>IODIS</sub> | —               | 0.5  | —    | 0.5  | —    | 0.5  | ns    |
| LVC MOS_33_16mA_out   | Using 3.3V CMOS Standard, 16mA Drive                 | t <sub>IOBUF</sub> , t <sub>IOEN</sub> , t <sub>IODIS</sub> | —               | 0.5  | —    | 0.5  | —    | 0.5  | ns    |
| LVC MOS_33_24mA_out   | Using 3.3V CMOS Standard, 24mA Drive                 | t <sub>IOBUF</sub> , t <sub>IOEN</sub> , t <sub>IODIS</sub> | —               | 0.5  | —    | 0.5  | —    | 0.5  | ns    |
| AGP_1X_out            | Using AGP 1x Standard                                | t <sub>IOBUF</sub> , t <sub>IOEN</sub> , t <sub>IODIS</sub> | —               | 0.5  | —    | 0.5  | —    | 0.5  | ns    |
| CTT25_out             | Using CTT 2.5V                                       | t <sub>IOBUF</sub> , t <sub>IOEN</sub> , t <sub>IODIS</sub> | —               | 0.5  | —    | 0.5  | —    | 0.5  | ns    |
| CTT33_out             | Using CTT 3.3V                                       | t <sub>IOBUF</sub> , t <sub>IOEN</sub> , t <sub>IODIS</sub> | —               | 0.5  | —    | 0.5  | —    | 0.5  | ns    |
| GTL+_out              | Using GTL+                                           | t <sub>IOBUF</sub> , t <sub>IOEN</sub> , t <sub>IODIS</sub> | —               | 0.5  | —    | 0.5  | —    | 0.5  | ns    |
| HSTL_I_out            | Using HSTL 2.5V, Class I                             | t <sub>IOBUF</sub> , t <sub>IOEN</sub> , t <sub>IODIS</sub> | —               | 0.5  | —    | 0.5  | —    | 0.5  | ns    |
| HSTL_III_out          | Using HSTL 2.5V, Class III                           | t <sub>IOBUF</sub> , t <sub>IOEN</sub> , t <sub>IODIS</sub> | —               | 0.5  | —    | 0.5  | —    | 0.5  | ns    |
| LVDS_out              | Using Low Voltage Differential Signaling (LVDS)      | t <sub>IOBUF</sub> , t <sub>IOEN</sub> , t <sub>IODIS</sub> | —               | 1.0  | —    | 1.0  | —    | 1.0  | ns    |
| BLVDS_out             | Using Bus Low Voltage Differential Signaling (BLVDS) | t <sub>IOBUF</sub> , t <sub>IOEN</sub> , t <sub>IODIS</sub> | —               | 1.0  | —    | 1.0  | —    | 1.0  | ns    |
| LVPECL_out            | Using Low Voltage PECL                               | t <sub>IOBUF</sub> , t <sub>IOEN</sub> , t <sub>IODIS</sub> | —               | 1.0  | —    | 1.0  | —    | 1.0  | ns    |
| PCI_out               | Using PCI Standard                                   | t <sub>IOBUF</sub> , t <sub>IOEN</sub> , t <sub>IODIS</sub> | —               | 0.5  | —    | 0.5  | —    | 0.5  | ns    |
| SSTL2_I_out           | Using SSTL 2.5V, Class I                             | t <sub>IOBUF</sub> , t <sub>IOEN</sub> , t <sub>IODIS</sub> | —               | 0.5  | —    | 0.5  | —    | 0.5  | ns    |
| SSTL2_II_out          | Using SSTL 2.5V, Class II                            | t <sub>IOBUF</sub> , t <sub>IOEN</sub> , t <sub>IODIS</sub> | —               | 0.5  | —    | 0.5  | —    | 0.5  | ns    |
| SSTL3_I_out           | Using SSTL 3.3V, Class I                             | t <sub>IOBUF</sub> , t <sub>IOEN</sub> , t <sub>IODIS</sub> | —               | 0.5  | —    | 0.5  | —    | 0.5  | ns    |
| SSTL3_II_out          | Using SSTL 3.3V, Class II                            | t <sub>IOBUF</sub> , t <sub>IOEN</sub> , t <sub>IODIS</sub> | —               | 0.5  | —    | 0.5  | —    | 0.5  | ns    |

1. Only available for ispXPGA 1200B and ispXPGA 1200EB (2.5V/3.3V) devices.

### sysHSI Block Timing

Figure 24 provides a graphical representation of the SERDES receiver input requirements. It provides guidance on a number of input parameters, including signal amplitude and rise time limits, noise and jitter limits, and P and N input skew tolerance.

**Figure 24. Receive Data Eye Diagram Template (Differential)**



The data pattern eye opening at the receive end of a link is considered the ultimate measure of received signal quality. Almost all detrimental characteristics of a transmit signal and the interconnection link design result in eye closure. This combined with the eye-opening limitations of the line receiver can provide a good indication of a link's ability to transfer error-free data.

Signal jitter is of special interest to system designers. It is often the primary limiting characteristic of long digital links and of systems with high noise level environments. An interesting characteristic of the clock and data recovery (CDR) portion of the ispXPGA SERDES receiver is its ability to filter incoming signal jitter that is below the clock recovery PLL bandwidth. For signals with high levels of low frequency jitter, the receiver can detect incoming data error free, with eye openings significantly less than that shown in Figure 24.

SELECTED DISCONTINUED

sysHSI Block AC Specifications

Operating Frequency Ranges

| Symbol                        | Description               | Mode   | Test Condition                                             | Device     | -5 <sup>1</sup> |      | -4   |      | -3   |      | Units |
|-------------------------------|---------------------------|--------|------------------------------------------------------------|------------|-----------------|------|------|------|------|------|-------|
|                               |                           |        |                                                            |            | Min.            | Max. | Min. | Max. | Min. | Max. |       |
| f <sub>CLK</sub>              | Reference Clock Frequency | SS:CAL |                                                            | LFX125B/C  | 50              | 200  | 50   | 200  | 50   | 200  | MHz   |
|                               |                           |        |                                                            | LFX200B/C  | 50              | 188  | 50   | 188  | 50   | 188  |       |
|                               |                           |        |                                                            | LFX500B/C  | 50              | 188  | 50   | 188  | 50   | 188  |       |
|                               |                           |        |                                                            | LFX1200B/C | 50              | 175  | 50   | 175  | 50   | 175  |       |
|                               |                           | 10B12B |                                                            | LFX125B/C  | 33              | 67   | 33   | 67   | 33   | 67   | MHz   |
|                               |                           |        |                                                            | LFX200B/C  | 33              | 63   | 33   | 63   | 33   | 63   |       |
|                               |                           |        |                                                            | LFX500B/C  | 33              | 63   | 33   | 63   | 33   | 63   |       |
|                               |                           |        |                                                            | LFX1200B/C | 33              | 58   | 33   | 58   | 33   | 58   |       |
|                               |                           | 8B10B  |                                                            | LFX125B/C  | 40              | 80   | 40   | 80   | 40   | 80   | MHz   |
|                               |                           |        |                                                            | LFX200B/C  | 40              | 75   | 40   | 75   | 40   | 75   |       |
|                               |                           |        |                                                            | LFX500B/C  | 40              | 75   | 40   | 75   | 40   | 75   |       |
|                               |                           |        |                                                            | LFX1200B/C | 40              | 70   | 40   | 70   | 40   | 70   |       |
| f <sub>SIN</sub> <sup>2</sup> | Serial Input              | SS:CAL | with eoSIN                                                 | LFX125B/C  | 400             | 800  | 400  | 800  | 400  | 800  | Mbps  |
|                               |                           |        |                                                            | LFX200B/C  | 400             | 750  | 400  | 750  | 400  | 750  |       |
|                               |                           |        |                                                            | LFX500B/C  | 400             | 750  | 400  | 750  | 400  | 750  |       |
|                               |                           |        |                                                            | LFX1200B/C | 400             | 700  | 400  | 700  | 400  | 700  |       |
|                               |                           | 10B12B |                                                            | LFX125B/C  | 400             | 800  | 400  | 800  | 400  | 800  | Mbps  |
|                               |                           |        |                                                            | LFX200B/C  | 400             | 750  | 400  | 750  | 400  | 750  |       |
|                               |                           |        |                                                            | LFX500B/C  | 400             | 750  | 400  | 750  | 400  | 750  |       |
|                               |                           |        |                                                            | LFX1200B/C | 400             | 700  | 400  | 700  | 400  | 700  |       |
|                               |                           | 8B10B  |                                                            | LFX125B/C  | 400             | 800  | 400  | 800  | 400  | 800  | Mbps  |
|                               |                           |        |                                                            | LFX200B/C  | 400             | 750  | 400  | 750  | 400  | 750  |       |
|                               |                           |        |                                                            | LFX500B/C  | 400             | 750  | 400  | 750  | 400  | 750  |       |
|                               |                           |        |                                                            | LFX1200B/C | 400             | 700  | 400  | 700  | 400  | 700  |       |
| f <sub>OUT</sub> <sup>2</sup> | Serial Out                | LVDS   | CL = 5 pF,<br>RL = 100Ω<br>f <sub>CLK</sub> with no jitter | LFX125B/C  | 400             | 800  | 400  | 800  | 400  | 800  | Mbps  |
|                               |                           |        |                                                            | LFX200B/C  | 400             | 750  | 400  | 750  | 400  | 750  |       |
|                               |                           |        |                                                            | LFX500B/C  | 400             | 750  | 400  | 750  | 400  | 750  |       |
|                               |                           |        |                                                            | LFX1200B/C | 400             | 700  | 400  | 700  | 400  | 700  |       |

1. Only available for ispXPGA 125B, 200B, 500B and 1200B (2.5V/3.3V) devices.
2. f<sub>SIN</sub> and f<sub>SOUT</sub> speeds are supported at V<sub>CC</sub> and V<sub>CCP</sub> at 1.7V to 1.9V for ispXPGA 1.8V devices.

LOCKIN Time

| Symbol               | Description                | Mode   | Condition                 | Min  | Max              | Unit                          |
|----------------------|----------------------------|--------|---------------------------|------|------------------|-------------------------------|
| t <sub>SCLOCK</sub>  | CSPLL Lock Time            | All    | After input is stabilized |      | 25               | μS                            |
| t <sub>CDRLOCK</sub> | CDRPLL Lock-in Time        | SS     | With SS mode sync pattern |      | 1024             | t <sub>RCP</sub> <sup>1</sup> |
|                      |                            | 10B12B | With 10B12B sync pattern  |      | 1024             | t <sub>RCP</sub>              |
|                      |                            | 8B10B  | With 8B10B idle pattern   |      | 960              | t <sub>RCP</sub>              |
| t <sub>SYNC</sub>    | SyncPat Length             | SS     |                           | 1200 | t <sub>RCP</sub> |                               |
| t <sub>CAL</sub>     | CAL Duration               | SS     |                           | 1100 | t <sub>RCP</sub> |                               |
| t <sub>SUSYNC</sub>  | SyncPat Set-up Time to CAL | SS     |                           | 50   | t <sub>RCP</sub> |                               |
| t <sub>HDSYNC</sub>  | SyncPat Hold Time from CAL | SS     |                           | 50   | t <sub>RCP</sub> |                               |

1. REFCLK clock period.



## REFCLK and SS\_CLKIN Timing

| Symbol          | Description                                                       | Mode             | Condition     | Min  | Max  | Unit |
|-----------------|-------------------------------------------------------------------|------------------|---------------|------|------|------|
| $t_{DREFCLK}$   | Frequency Deviation Between TX REFCLK and CDRX REFCLK on One Link | 8B10B/<br>10B12B |               | -100 | 100  | ppm  |
| $t_{JPPREFCLK}$ | REFCLK, SS_CLKIN Peak-to-Peak Period Jitter                       | All              | Random Jitter |      | 0.01 | UIPP |
| $t_{PWREFCLK}$  | REFCLK, SS_CLKIN Pulse Width, (80% to 80% or 20% to 20%).         | All              | 40-100MHz     | 2    |      | ns   |
|                 |                                                                   |                  | 100-200MHz    | 1    |      |      |
| $t_{RFREFCLK}$  | REFCLK, SS_CLKIN Rise/Fall Time (20% to 80% or 80% to 20%)        | All              |               |      | 2    | ns   |

Serializer Timing<sup>2</sup>

| Symbol            | Description                                | Mode     | Condition                | Min                | Max                | Unit |
|-------------------|--------------------------------------------|----------|--------------------------|--------------------|--------------------|------|
| $t_{JPPSOUT}$     | SOUT Peak-to-Peak Output Data Jitter       | All      | $f_{CLK}$ with no jitter |                    | 0.25               | UIPP |
| $t_{JPP8B10B}$    | SOUT Peak-to-Peak Random Jitter            | 8B10B    | 800 Mbps w/K28.7-        |                    | 130                | ps   |
|                   | SOUT Peak-to-Peak Deterministic Jitter     | 8B10B    | 800 Mbps w/K28.5+        |                    | 160                | ps   |
| $t_{RFSOUT}$      | SOUT Output Data Rise/Fall Time (20%, 80%) | LVDS     |                          |                    | 700                | ps   |
| $t_{COSOUT}$      | REFCLK to SOUT Delay                       | SS/8B10B |                          | $2Bt^1 + 2$        | $2Bt^1 + 10$       | ns   |
|                   |                                            | 10B12B   |                          | $1Bt^1 + 2$        | $1Bt^1 + 10$       | ns   |
| $t_{SKTX}$        | Skew of SOUT with Respect to SS_CLKOUT     | SS       |                          |                    | 300                | ps   |
| $t_{CKOSOUT}$     | SS_CLKOUT to bit0 of SOUT                  | SS       |                          | $2Bt^1 - t_{SKTX}$ | $2Bt^1 + t_{SKTX}$ | ns   |
| $t_{HSITXDDATAS}$ | TXD Data Setup Time                        | All      | Note 3                   | 1.5                |                    | ns   |
| $t_{HSITXDDATAH}$ | TXD Data Hold Time                         | All      | Note 3                   |                    | 1.0                | ns   |

1. Bt: Bit Time Period. High Speed Serial Bit Time.

2. The SIN and SOUT jitter specifications listed above are under the condition that the clock tree that drives the REFCLK to sysHSI Block is in sysCLOCK PLL BYPASS mode.

3. Internal timing for reference only.

## Deserializer Timing

| Symbol                | Description                                            | Mode             | Conditions | Min                       | Max                        | Units |
|-----------------------|--------------------------------------------------------|------------------|------------|---------------------------|----------------------------|-------|
| $f_{DSIN}$            | SIN Frequency Deviation from REFCLK                    | 8B10B/<br>10B12B |            | -100                      | 100                        | ppm   |
| $e_{OSIN}$            | SIN Eye Opening Tolerance                              | All              | Notes 1, 2 | 0.45                      |                            | UIPP  |
| ber                   | Bit Error Rate                                         | All              |            |                           | $10^{-12}$                 | Bits  |
| $t_{HSIOUTVALIDPRE}$  | RXD, SYDT Valid Time Before RECCLK Falling Edge        | All              | Note 3     | $t_{RCP}/2 - 0.7$         |                            | ns    |
| $t_{HSIOUTVALIDPOST}$ | RXD, SYDT Valid Time After RECCLK Falling Edge         | All              | Note 3     | $t_{RCP}/2 - 0.7$         |                            | ns    |
| $t_{DSIN}$            | Bit 0 of SIN Delay to RXD Valid at RECCLK Falling edge | All              |            | $1.5 t_{RCP} + 4.5Bt + 3$ | $1.5 t_{RCP} + 4.5Bt + 15$ | ns    |

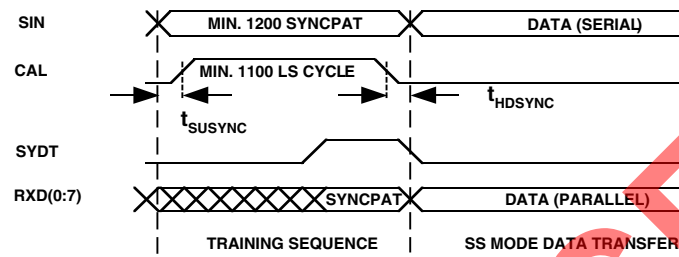
1. Eye opening based on jitter frequency of 100KHz.

2. Lower frequency operation assumes maximum eye closure of 800ps.

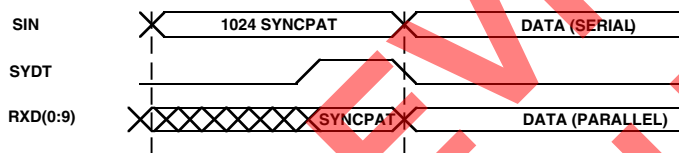
3. Internal timing for reference only.

Lock-in Timing

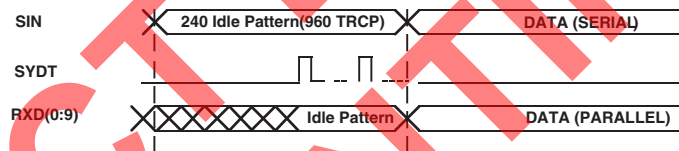
CDRX\_SS LOCK-IN (DE-SKEW) TIMING



CDR\_10B12B LOCK-IN TIMING

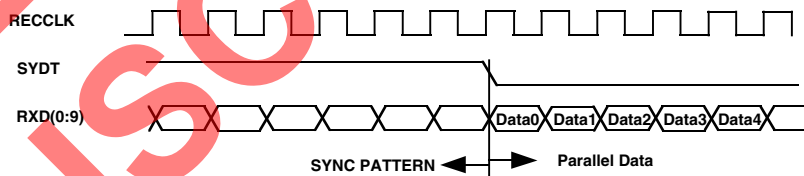


CDR\_8B10B LOCK-IN TIMING

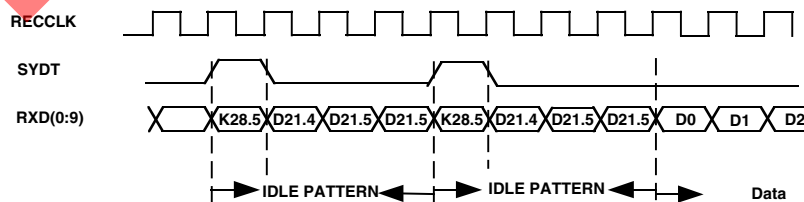


SYDT Timing

SYDT TIMING FOR CDRX\_10B12B

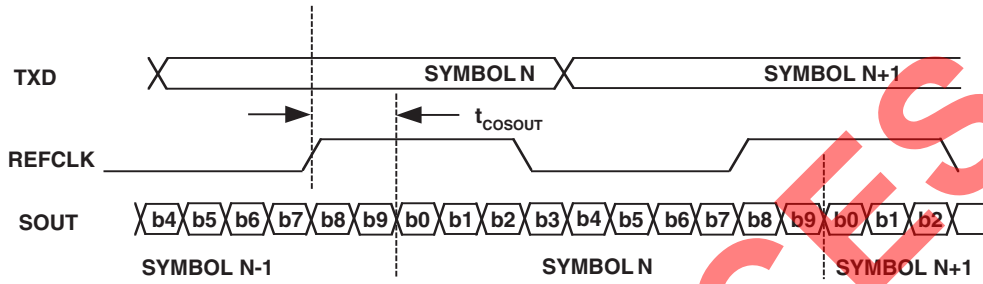


SYDT TIMING FOR CDRX\_8B10B

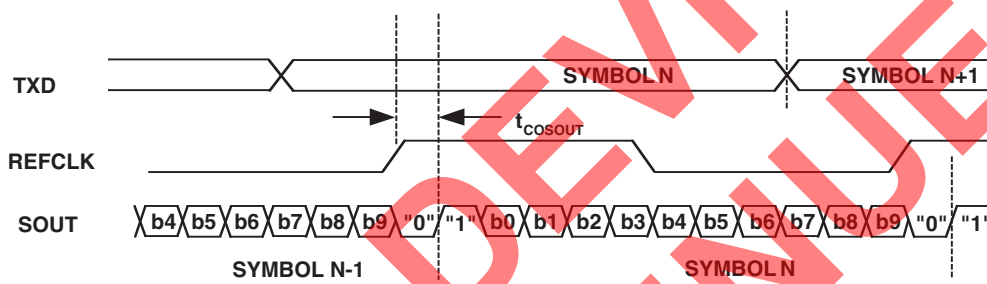


Serializer Timing

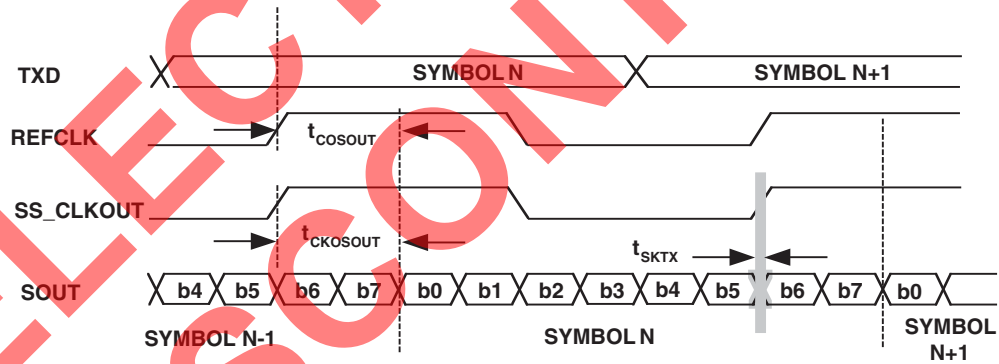
8B/10B SERIALIZER DELAY TIMING



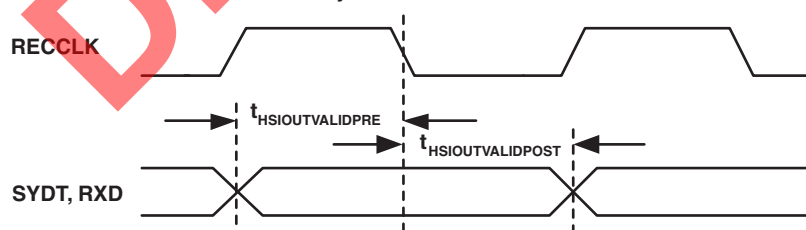
10B/12B SERIALIZER DELAY TIMING



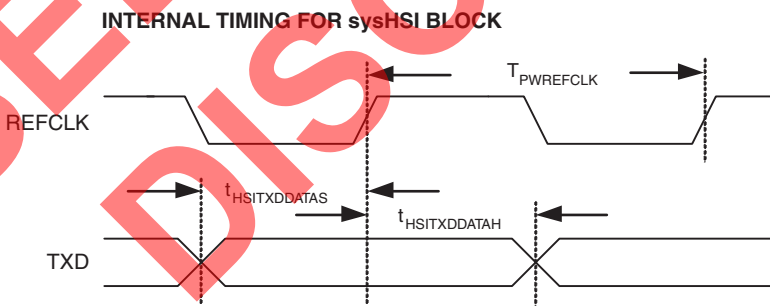
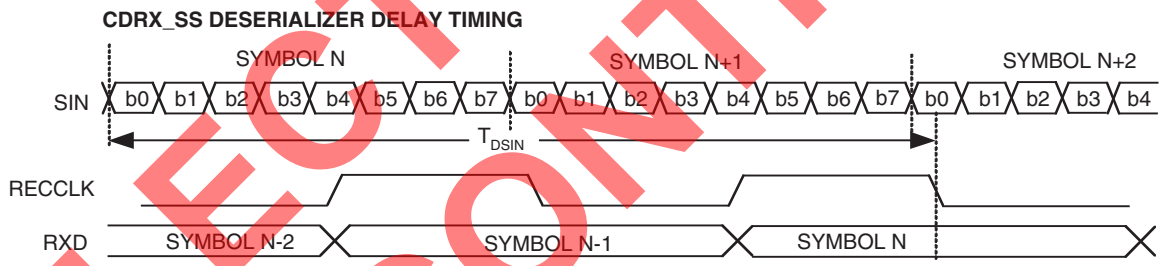
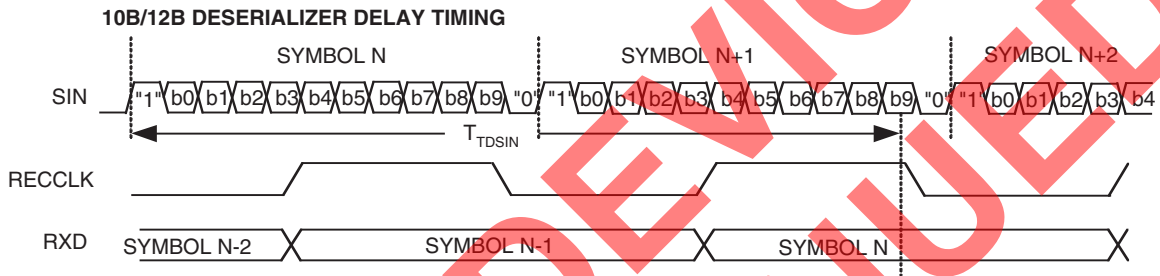
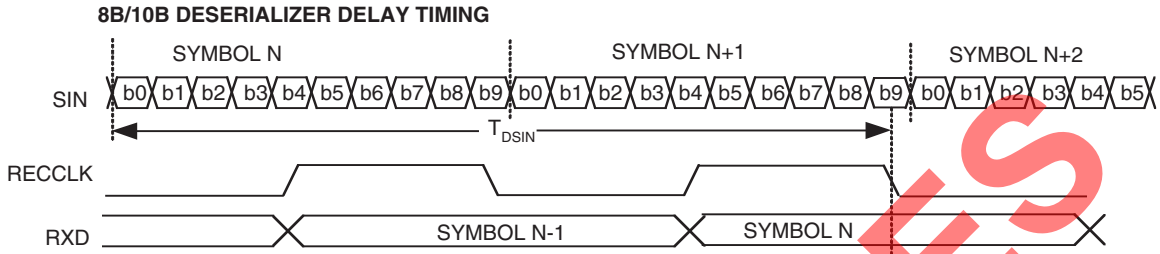
SS Mode SERIALIZER DELAY TIMING



INTERNAL TIMING FOR sysHSI BLOCK



**Deserializer Timing**



### sysCLOCK PLL Timing

Over Recommended Operating Conditions

| Symbol                             | Parameter                                     | Conditions                                                                                                         | Min      | Max      | Units |
|------------------------------------|-----------------------------------------------|--------------------------------------------------------------------------------------------------------------------|----------|----------|-------|
| t <sub>PWH</sub>                   | Input clock, high time                        | 80% to 80%                                                                                                         | 1.2      | —        | ns    |
| t <sub>PWL</sub>                   | Input clock, low time                         | 20% to 20%                                                                                                         | 1.2      | —        | ns    |
| t <sub>R</sub> , t <sub>F</sub>    | Input Clock, rise and fall time               | 20% to 80%                                                                                                         | —        | 3.0      | ns    |
| t <sub>INSTB</sub>                 | Input clock stability, cycle to cycle (peak)  |                                                                                                                    | —        | +/- 250  | ps    |
| f <sub>MDIVIN</sub>                | M Divider input, frequency range              |                                                                                                                    | 10       | 320      | MHz   |
| f <sub>MDIVOUT</sub>               | M Divider output, frequency range             |                                                                                                                    | 10       | 320      | MHz   |
| f <sub>NDIVIN</sub>                | N Divider input, frequency range              |                                                                                                                    | 10       | 320      | MHz   |
| f <sub>NDIVOUT</sub>               | N Divider output, frequency range             |                                                                                                                    | 10       | 320      | MHz   |
| f <sub>VDIVIN</sub>                | V Divider input, frequency range              |                                                                                                                    | 100      | 400      | MHz   |
| f <sub>VDIVOUT</sub>               | V Divider output, frequency range             |                                                                                                                    | 10       | 320      | MHz   |
| t <sub>OUTDUTY</sub>               | output clock, duty cycle                      |                                                                                                                    | 40       | 60       | %     |
| t <sub>JIT(CC)</sub>               | Output clock, cycle to cycle jitter (peak)    | Clean reference <sup>1</sup><br>10MHz ÷ f <sub>MDIVOUT</sub> ÷ 40MHz or<br>100MHz ÷ f <sub>VDIVIN</sub> ÷ 160MHz   | —        | +/- 600  | ps    |
|                                    |                                               | Clean reference <sup>1</sup><br>40MHz ÷ f <sub>MDIVOUT</sub> ÷ 320MHz and<br>160MHz ÷ f <sub>VDIVIN</sub> ÷ 400MHz | —        | +/- 150  | ps    |
| t <sub>JIT(PER)</sub> <sup>2</sup> | Output clock, period jitter (peak)            | Clean reference <sup>1</sup><br>10MHz ÷ f <sub>MDIVOUT</sub> ÷ 40MHz or<br>100MHz ÷ f <sub>VDIVIN</sub> ÷ 160MHz   | —        | +/- 600  | ps    |
|                                    |                                               | Clean reference <sup>1</sup><br>40MHz ÷ f <sub>MDIVOUT</sub> ÷ 320MHz and<br>160MHz ÷ f <sub>VDIVIN</sub> ÷ 400MHz | —        | +/- 150  | ps    |
| t <sub>CLK_OUT_DELAY</sub>         | Input clock to CLK_OUT delay                  | Internal feedback                                                                                                  | —        | 3.0      | ns    |
| t <sub>PHASE</sub>                 | Input clock to external feedback delta        | External feedback                                                                                                  | —        | 1.5      | ns    |
| t <sub>LOCK</sub>                  | Time to acquire phase lock after input stable |                                                                                                                    | —        | 25       | us    |
| t <sub>PLL_DELAY</sub>             | Delay increment (Lead/Lag)                    | Typical = +/- 250ps                                                                                                | +/- 120  | +/- 550  | ps    |
| t <sub>RANGE</sub>                 | Total output delay range (lead/lag)           |                                                                                                                    | +/- 0.84 | +/- 3.85 | ns    |
| t <sub>PLL_RSTW</sub>              | Minimum reset pulse width                     |                                                                                                                    | 1.8      | —        | ns    |
| t <sub>CLK_IN</sub> <sup>3</sup>   | Global clock input delay                      |                                                                                                                    | —        | 1.0      | ns    |
| t <sub>PLL_SEC_DELAY</sub>         | Secondary PLL output delay                    |                                                                                                                    | —        | 1.5      | ns    |

1. This condition assures that the output phase jitter will remain within specifications. Jitter spec is based on optimized M, N and V settings determined by the ispLEVER software.

2. Accumulated jitter measured over 10,000 waveform samples

3. Internal timing for reference only.

## ispXP sysCONFIG Port Timing Specifications

| Symbol                              | Timing Parameter                            | Min. | Typ. | Max. | Units |
|-------------------------------------|---------------------------------------------|------|------|------|-------|
| <b>sysCONFIG Write Cycle Timing</b> |                                             |      |      |      |       |
| $t_{SUCS}$                          | Input setup time of CS to CCLK rise         | 10   | —    | —    | ns    |
| $t_{HCS}$                           | Hold time of CS to CCLK Rise                | 0    | —    | —    | ns    |
| $t_{SUWD}$                          | Input setup time of write data to CCLK rise | 12   | —    | —    | ns    |
| $t_{HWD}$                           | Hold time of write data to CCLK rise        | 0    | —    | —    | ns    |
| $t_{PRGM}$                          | Low time to reset device SRAM               | 5    | —    | 50   | ns    |
| $t_{WINIT}$                         | INIT pulse width                            | —    | —    | 5    | ms    |
| $t_{IODISS}$                        | User I/O disable                            | —    | —    | 30   | ns    |
| $t_{IOENSS}$                        | User I/O enable                             | —    | —    | 30   | ns    |
| $t_{WH}$                            | Write clock High pulse width                | 12   | —    | —    | ns    |
| $t_{WL}$                            | Write clock Low pulse width                 | 12   | —    | —    | ns    |
| $f_{MAXW}$                          | Write $f_{MAX}$                             | —    | —    | 33   | MHz   |
| <b>sysCONFIG Read Cycle Timing</b>  |                                             |      |      |      |       |
| $t_{HREAD}$                         | Hold time of READ to CCLK rise              | 0    | —    | —    | ns    |
| $t_{SUREAD}$                        | Input setup time of READ High to CCLK rise  | 30   | —    | —    | ns    |
| $t_{RH}$                            | READ clock high pulse width                 | 12   | —    | —    | ns    |
| $t_{RL}$                            | READ clock low pulse width                  | 15   | —    | —    | ns    |
| $f_{MAXR}$                          | Read $f_{MAX}$                              | —    | —    | 33   | MHz   |
| $t_{CORD}$                          | Clock to out for read data                  | —    | —    | 25   | ns    |

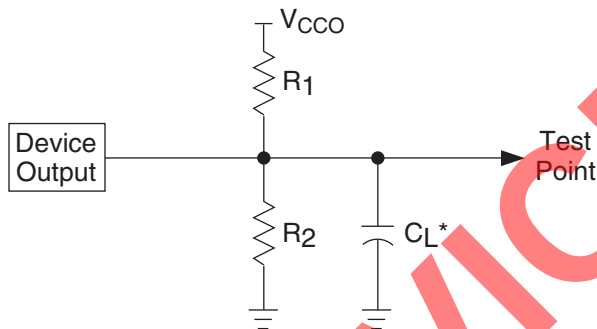
## Boundary Scan Timing

| Parameter     | Description                                                        | Min. | Max. | Units |
|---------------|--------------------------------------------------------------------|------|------|-------|
| $t_{BTCP}$    | TCK [BSCAN] Clock Pulse Width                                      | 40   | —    | ns    |
| $t_{BTCPH}$   | TCK [BSCAN] Clock Pulse Width High                                 | 20   | —    | ns    |
| $t_{BTCPH}$   | TCK [BSCAN] Clock Pulse Width High                                 | 20   | —    | ns    |
| $t_{BTCPL}$   | TCK [BSCAN] Clock Pulse Width Low                                  | 20   | —    | ns    |
| $t_{BTS}$     | TCK [BSCAN] Setup Time                                             | 8    | —    | ns    |
| $t_{BTH}$     | TCK [BSCAN] Hold Time                                              | 10   | —    | ns    |
| $t_{BTRF}$    | TCK [BSCAN] Rise/Fall Time                                         | 50   | —    | mV/ns |
| $t_{BTCO}$    | TAP Controller Falling Edge of Clock to Valid Output               | —    | 18   | ns    |
| $t_{BTCODIS}$ | TAP Controller Falling Edge of Clock to Valid Disable              | —    | 18   | ns    |
| $t_{BTCOEN}$  | TAP Controller Falling Edge of Clock to Valid Enable               | —    | 18   | ns    |
| $t_{BTCRS}$   | BSCAN Test Capture Register Setup Time                             | 8    | —    | ns    |
| $t_{BTCRH}$   | BSCAN Test Capture Register Hold Time                              | 25   | —    | ns    |
| $t_{BUTCO}$   | BSCAN Test Update Register, Falling Edge of Clock to Valid Output  | —    | 45   | ns    |
| $t_{BTUODIS}$ | BSCAN Test Update Register, Falling Edge of Clock to Valid Disable | —    | 20   | ns    |
| $t_{BTUPOEN}$ | BSCAN Test Update Register, Falling Edge of Clock to Valid Enable  | —    | 20   | ns    |

### Switching Test Conditions

Figure 25 shows the output test load that is used for AC testing. The specific values for resistance, capacitance, voltage, and other test conditions are shown in Table 7.

Figure 25. Output Test Load, LVTTTL and LVCMOS Standards



\*C<sub>L</sub> includes test fixture and probe capacitance.

Table 7. Text Fixture Required Components

| Test Condition                  | R <sub>1</sub> | R <sub>2</sub> | C <sub>L</sub> | Timing Reference                 | VCCO               |
|---------------------------------|----------------|----------------|----------------|----------------------------------|--------------------|
| LVCMOS I/O, (L -> H, H -> L)    | 106            | 106            | 35pF           | LVCMOS 3.3 = V <sub>CCO</sub> /2 | LVCMOS 3.3 = 3.0V  |
|                                 |                |                |                | LVCMOS 2.5 = V <sub>CCO</sub> /2 | LVCMOS 2.5 = 2.3V  |
|                                 |                |                |                | LVCMOS 1.8 = V <sub>CCO</sub> /2 | LVCMOS 1.8 = 1.65V |
| Default LVCMOS 1.8 I/O (Z -> H) | x              | 106            | 35pF           | 0.9V                             | 1.65V              |
| Default LVCMOS 1.8 I/O (Z -> L) | 106            | x              | 35pF           | 0.9V                             | 1.65V              |
| Default LVCMOS 1.8 I/O (H -> Z) | x              | 106            | 5pF            | V <sub>OH</sub> - 0.3            | 1.65V              |
| Default LVCMOS 1.8 I/O (L -> Z) | 106            | x              | 5pF            | V <sub>OL</sub> + 0.3            | 1.65V              |

Note: Output test conditions for all other interfaces are determined by the respective standards.

Signal Descriptions<sup>1</sup>

| Signal Name                           | Signal Type     | Description                                                                                                     |
|---------------------------------------|-----------------|-----------------------------------------------------------------------------------------------------------------|
| <b>General Purpose</b>                |                 |                                                                                                                 |
| BKy_IOx <sup>1,2</sup>                | Input/Output    | General purpose I/O number x in I/O Bank y                                                                      |
| GCLKn/In <sup>7</sup>                 | Input           | Global clock/input <sup>8</sup>                                                                                 |
| GSR                                   | Input           | Global Set/Reset                                                                                                |
| NC                                    | —               | No Connect                                                                                                      |
| GND                                   | GND             | Ground                                                                                                          |
| V <sub>CC</sub>                       | VCC             | Core logic power supply                                                                                         |
| V <sub>CCJ</sub>                      | VCC             | IEEE 1149.1 TAP power supply                                                                                    |
| V <sub>CCOy</sub> <sup>2</sup>        | VCC             | I/O Bank y power supply                                                                                         |
| V <sub>REFy</sub> <sup>2</sup>        | Input           | I/O Bank y reference voltage                                                                                    |
| D <sub>XN</sub> , D <sub>XP</sub>     | Output          | Temperature Sensing Diodes, provide a differential voltage, which corresponds to the temperature of the device. |
| <b>Test and Program/Configuration</b> |                 |                                                                                                                 |
| TMS                                   | Input           | Test Mode Select                                                                                                |
| TCK                                   | Input           | Test Clock                                                                                                      |
| TDI                                   | Input           | Test Data In                                                                                                    |
| TDO                                   | Output          | Test Data Out                                                                                                   |
| TOE                                   | Input           | Test Output Enable tri-states all I/O pins when driven low                                                      |
| CFG0                                  | Input           | Selects the SRAM memory configuration type (Peripheral or E <sup>2</sup> CMOS Refresh)                          |
| PROGRAMb                              | Input           | Initiates download from E <sup>2</sup> CMOS or the peripheral port to SRAM memory (active low)                  |
| DONE                                  | Bi-directional  | Indicates when configuration is complete                                                                        |
| INITb                                 | Bi-directional  | Indicates the device is ready for programming (active low)                                                      |
| READ                                  | Input           | Selects the READ operation when in sysCONFIG mode                                                               |
| CCLK                                  | Input           | sysCONFIG Configuration Clock                                                                                   |
| CSb                                   | Input           | sysCONFIG Chip Select (active low)                                                                              |
| DATA[0:7]                             | Bi-directional  | sysCONFIG Peripheral Port Data I/O                                                                              |
| <b>sysCLOCK PLL<sup>3</sup></b>       |                 |                                                                                                                 |
| PLL_FBKz                              | Input           | Optional external feedback                                                                                      |
| PLL_RSTz                              | Input           | Optional external M divider reset                                                                               |
| CLK_OUTz                              | Internal Signal | Clock output (routable to any I/O)                                                                              |
| PLL_LOCKz                             | Internal Signal | Lock output (routable to any I/O)                                                                               |
| GND <sub>P0</sub>                     | GND             | Left side PLL Ground                                                                                            |
| GND <sub>P1</sub>                     | GND             | Right side PLL Ground                                                                                           |
| V <sub>CCP0</sub>                     | VCC             | Left side PLL power supply                                                                                      |
| V <sub>CCP1</sub>                     | VCC             | Right side PLL power supply                                                                                     |
| <b>sysHSI Block<sup>4,5</sup></b>     |                 |                                                                                                                 |
| HSImA_SINP, HSImB_SINP                | Input           | P-side of differential serial data input                                                                        |
| HSImA_SINN, HSImB_SINN                | Input           | N-side of differential serial data input                                                                        |
| HSImA_SOUTP, HSImB_SOUTP              | Output          | P-side of differential serial data output                                                                       |
| HSImA_SOUTN, HSImB_SOUTN              | Output          | N-side of differential serial data output                                                                       |
| HSImA_SYDT, HSImB_SYDT                | Internal Signal | Symbol alignment detect                                                                                         |
| HSImA_RECCLK, HSImB_RECCLK            | Internal Signal | Recovered clock                                                                                                 |



**Signal Descriptions<sup>1</sup> (Cont.)**

| Signal Name                                               | Signal Type     | Description                                       |
|-----------------------------------------------------------|-----------------|---------------------------------------------------|
| HSImA_CDRRST, HSImB_CDRRST                                | Input           | CDR Reset                                         |
| HSIm_CSLOCK, HSIm_CSLOCK                                  | Internal Signal | Indicates when the CSPLL circuit is locked        |
| <b>sysHSI Block (Source Synchronous Mode)<sup>8</sup></b> |                 |                                                   |
| SS_CLKIN0P, SS_CLKIN1P                                    | Input           | P-side of differential clock input                |
| SS_CLKIN0N, SS_CLKIN1N                                    | Input           | N-side of differential clock input                |
| SS_CLKOUT0P, SS_CLKOUT1P                                  | Output          | P-side of differential clock output               |
| SS_CLKOUT0N, SS_CLKOUT1N                                  | Output          | N-side of differential clock output               |
| CAL0, CAL1                                                | Input           | Initiates source synchronous calibration sequence |

1. x is a variable for the I/O number.
2. y is a variable for the I/O Bank.
3. z is a variable for the PLL number.
4. m is a variable for the sysHSI block number.
5. A and B refer to the sysHSI block channels.
6. 0 and 1 refer to Source Synchronous group 0 and 1
7. n is a variable for the GCLK and Input number
8. See Logic Signal Connections Table for differential pairing.

SELECT DEVICES DISCONTINUED

ispXPGA Power Supply and NC Connections<sup>1</sup>

| Signal            | 256-Ball fpBGA <sup>3</sup>                                                                                                                                                  | 516-Ball fpBGA <sup>3</sup>                                                                                                                                                                                                                                                                                                                                                                                                                                                                                                                                                                                                                                                                                                                                                                                                                                                                                                                                                                                                                                                                                                                                                                                                                                                                                                                                                                                                                                                                                                                     |
|-------------------|------------------------------------------------------------------------------------------------------------------------------------------------------------------------------|-------------------------------------------------------------------------------------------------------------------------------------------------------------------------------------------------------------------------------------------------------------------------------------------------------------------------------------------------------------------------------------------------------------------------------------------------------------------------------------------------------------------------------------------------------------------------------------------------------------------------------------------------------------------------------------------------------------------------------------------------------------------------------------------------------------------------------------------------------------------------------------------------------------------------------------------------------------------------------------------------------------------------------------------------------------------------------------------------------------------------------------------------------------------------------------------------------------------------------------------------------------------------------------------------------------------------------------------------------------------------------------------------------------------------------------------------------------------------------------------------------------------------------------------------|
| V <sub>CC</sub>   | C3, C14, D4, D13, E5, E12, F6, F11, L6, L11, M5, M12, N4, N13, P3, P14                                                                                                       | A9, A22, D4, D27, J1, J30, L11, L12, L15, L16, L19, L20, M11, M20, R11, R20, T11, T20, W11, W20, Y11, Y12, Y15, Y16, Y19, Y20, AB1, AB30, AG4, AG27, AK9, AK22                                                                                                                                                                                                                                                                                                                                                                                                                                                                                                                                                                                                                                                                                                                                                                                                                                                                                                                                                                                                                                                                                                                                                                                                                                                                                                                                                                                  |
| V <sub>CC00</sub> | F5, G5                                                                                                                                                                       | F4, J4, M4, N11, P4, P11                                                                                                                                                                                                                                                                                                                                                                                                                                                                                                                                                                                                                                                                                                                                                                                                                                                                                                                                                                                                                                                                                                                                                                                                                                                                                                                                                                                                                                                                                                                        |
| V <sub>CC01</sub> | K5, L5                                                                                                                                                                       | U4, U11, V11, W4, AB4, AE4                                                                                                                                                                                                                                                                                                                                                                                                                                                                                                                                                                                                                                                                                                                                                                                                                                                                                                                                                                                                                                                                                                                                                                                                                                                                                                                                                                                                                                                                                                                      |
| V <sub>CC02</sub> | M6, M7                                                                                                                                                                       | Y13, Y14, AG6, AG9, AG12, AG14                                                                                                                                                                                                                                                                                                                                                                                                                                                                                                                                                                                                                                                                                                                                                                                                                                                                                                                                                                                                                                                                                                                                                                                                                                                                                                                                                                                                                                                                                                                  |
| V <sub>CC03</sub> | M10, M11                                                                                                                                                                     | Y17, Y18, AG17, AG19, AG22, AG25                                                                                                                                                                                                                                                                                                                                                                                                                                                                                                                                                                                                                                                                                                                                                                                                                                                                                                                                                                                                                                                                                                                                                                                                                                                                                                                                                                                                                                                                                                                |
| V <sub>CC04</sub> | K12, L12                                                                                                                                                                     | U20, U27, V20, W27, AB27, AE27                                                                                                                                                                                                                                                                                                                                                                                                                                                                                                                                                                                                                                                                                                                                                                                                                                                                                                                                                                                                                                                                                                                                                                                                                                                                                                                                                                                                                                                                                                                  |
| V <sub>CC05</sub> | G12, F12                                                                                                                                                                     | F27, J27, M27, N20, P20, P27                                                                                                                                                                                                                                                                                                                                                                                                                                                                                                                                                                                                                                                                                                                                                                                                                                                                                                                                                                                                                                                                                                                                                                                                                                                                                                                                                                                                                                                                                                                    |
| V <sub>CC06</sub> | E10, E11                                                                                                                                                                     | D17, D19, D22, D25, L17, L18                                                                                                                                                                                                                                                                                                                                                                                                                                                                                                                                                                                                                                                                                                                                                                                                                                                                                                                                                                                                                                                                                                                                                                                                                                                                                                                                                                                                                                                                                                                    |
| V <sub>CC07</sub> | E6, E7                                                                                                                                                                       | D6, D9, D12, D14, L13, L14                                                                                                                                                                                                                                                                                                                                                                                                                                                                                                                                                                                                                                                                                                                                                                                                                                                                                                                                                                                                                                                                                                                                                                                                                                                                                                                                                                                                                                                                                                                      |
| V <sub>CCP</sub>  | H3, J15                                                                                                                                                                      | R4, T30                                                                                                                                                                                                                                                                                                                                                                                                                                                                                                                                                                                                                                                                                                                                                                                                                                                                                                                                                                                                                                                                                                                                                                                                                                                                                                                                                                                                                                                                                                                                         |
| V <sub>CCJ</sub>  | A2                                                                                                                                                                           | C4                                                                                                                                                                                                                                                                                                                                                                                                                                                                                                                                                                                                                                                                                                                                                                                                                                                                                                                                                                                                                                                                                                                                                                                                                                                                                                                                                                                                                                                                                                                                              |
| GND               | A1, A16, B2, B15, F7, F8, F9, F10, G6, G7, G8, G9, G10, G11, H6, H7, H8, H9, H10, H11, J6, J7, J8, J9, J10, J11, K6, K7, K8, K9, K10, K11, L7, L8, L9, L10, R2, R15, T1, T16 | A1, A30, B2, B29, C3, C28, M12, M13, M14, M15, M16, M17, M18, M19, N12, N13, N14, N15, N16, N17, N18, N19, P12, P13, P14, P15, P16, P17, P18, P19, R12, R13, R14, R15, R16, R17, R18, R19, T12, T13, T14, T15, T16, T17, T18, T19, U12, U13, U14, U15, U16, U17, U18, U19, V12, V13, V14, V15, V16, V17, V18, V19, W12, W13, W14, W15, W16, W17, W18, W19, AH3, AH28, AJ2, AJ29, AK1, AK30                                                                                                                                                                                                                                                                                                                                                                                                                                                                                                                                                                                                                                                                                                                                                                                                                                                                                                                                                                                                                                                                                                                                                      |
| GND <sub>P</sub>  | H15, J4                                                                                                                                                                      | R29, T4                                                                                                                                                                                                                                                                                                                                                                                                                                                                                                                                                                                                                                                                                                                                                                                                                                                                                                                                                                                                                                                                                                                                                                                                                                                                                                                                                                                                                                                                                                                                         |
| NC <sup>2</sup>   | —                                                                                                                                                                            | <p><b>LFX125:</b> A10, A13, A16, A17, A24, A25, A26, A4, A5, A6, A7, AA1, AA2, AA28, AA29, AA3, AB28, AC1, AC28, AD1, AD27, AD4, AE28, AE29, AE3, AE30, AF27, AF28, AF29, AF3, AF4, AG1, AG10, AG11, AG15, AG2, AG20, AG23, AG24, AG29, AG3, AG8, AH1, AH15, AH19, AH2, AH20, AH23, AH24, AH30, AH7, AH8, AH9, AJ1, AJ12, AJ14, AJ15, AJ19, AJ20, AJ21, AJ23, AJ24, AJ25, AJ27, AJ30, AJ6, AJ7, AJ8, AK11, AK14, AK15, AK20, AK21, AK23, AK24, AK25, AK27, AK5, AK6, AK7, B10, B13, B16, B17, B18, B23, B24, B25, B5, B6, B7, C11, C13, C14, C16, C17, C22, C23, C24, C25, C6, C7, C8, D11, D16, D23, D24, D28, D29, D3, D7, D8, E30, E4, F1, F29, F30, G1, G2, G27, G28, G29, G30, H1, H2, H27, H28, H29, H30, J2, J28, J29, J3, K1, K2, K27, K28, K3, K4, L1, L2, L27, L3, L4, M1, M2, M29, M3, M30, V27, V28, V3, V4, W1, W30, Y1, Y27, Y28, Y3, Y30</p> <p><b>LFX200:</b> A26, A25, A24, A17, A10, A7, A6, A5, A4, B25, B24, B23, B17, B10, B7, B6, B5, C25, C24, C23, C22, C16, C11, C8, C7, C6, D24, D23, D16, D11, D8, D7, E30, F30, F29, F1, G30, G29, G28, G27, G2, G1, H30, H29, H28, H27, H2, H1, J29, J28, J3, J2, K28, K27, K4, K3, K2, K1, L27, L4, L3, L2, L1, M3, V28, V27, V4, V3, W30, W1, Y30, Y28, Y27, Y3, Y1, AA29, AA28, AA3, AA2, AA1, AD27, AD4, AE28, AE3, AF29, AF28, AF27, AF3, AG29, AG24, AG23, AG20, AG11, AG10, AG8, AG2, AG1, AH30, AH24, AH23, AH20, AH9, AH8, AH7, AH2, AH1, AJ30, AJ27, AJ25, AJ24, AJ23, AJ21, AJ15, AJ12, AJ8, AJ7, AJ6, AJ1, AK27, AK25, AK24, AK23, AK21, AK15, AK11, AK7, AK6, AK5</p> |

1. All grounds must be electrically connected at the board level.
2. NC pins should not be connected to any active signals, V<sub>CC</sub> or GND.
3. Balls for GND, V<sub>CC</sub> and V<sub>CC0x</sub> are connected within the substrate to their respective common signals. Pin orientation A1 starts from the upper left corner of the top side view with alphabetical order ascending vertically and numerical order ascending horizontally.

**ispXPGA Power Supply and NC Connections<sup>1</sup> (Continued)**

| Signal            | 680-Ball fpBGA <sup>3</sup>                                                                                                                                                                                                                                                                | 900-Ball fpBGA <sup>3</sup>                                                                                                                                                                                                                                                                                                                        |
|-------------------|--------------------------------------------------------------------------------------------------------------------------------------------------------------------------------------------------------------------------------------------------------------------------------------------|----------------------------------------------------------------------------------------------------------------------------------------------------------------------------------------------------------------------------------------------------------------------------------------------------------------------------------------------------|
| V <sub>CC</sub>   | AE35, AE5, AL5, AR15, AR25, AR31, AR35, AR5, AT36, AT4, AU3, AU37, C3, C37, D36, D4, E15, E25, E35, E5, E9, J35, R35, R5                                                                                                                                                                   | L11, L20, M12, M13, M14, M17, M18, M19, N12, N19, P12, P19, U12, U19, V12, V19, W12, W13, W14, W17, W18, W19, Y11, Y20                                                                                                                                                                                                                             |
| V <sub>CC00</sub> | E11, E12, E13, E17, E18, E7                                                                                                                                                                                                                                                                | K3, L10, M11, N11, N5, P11, R11, R12                                                                                                                                                                                                                                                                                                               |
| V <sub>CC01</sub> | E22, E23, E27, E29, E31, E33                                                                                                                                                                                                                                                               | AA3, T11, T12, U11, V11, V5, W11, Y10                                                                                                                                                                                                                                                                                                              |
| V <sub>CC02</sub> | G35, L35, M35, N35, U35, V35                                                                                                                                                                                                                                                               | AA11, AF13, AH10, W15, Y12, Y13, Y14, Y15                                                                                                                                                                                                                                                                                                          |
| V <sub>CC03</sub> | AB35, AC35, AG35, AJ35, AL35, AN35                                                                                                                                                                                                                                                         | AA20, AF18, AH21, W16, Y16, Y17, Y18, Y19                                                                                                                                                                                                                                                                                                          |
| V <sub>CC04</sub> | AR22, AR23, AR27, AR28, AR29, AR33                                                                                                                                                                                                                                                         | AA28, T19, T20, U20, V20, V26, W20, Y21                                                                                                                                                                                                                                                                                                            |
| V <sub>CC05</sub> | AR11, AR13, AR17, AR18, AR7, AR9                                                                                                                                                                                                                                                           | K28, L21, M20, N20, N26, P20, R19, R20                                                                                                                                                                                                                                                                                                             |
| V <sub>CC06</sub> | AB5, AC5, AG5, AH5, AJ5, AN5                                                                                                                                                                                                                                                               | C21, E18, K20, L16, L17, L18, L19, M16                                                                                                                                                                                                                                                                                                             |
| V <sub>CC07</sub> | G5, J5, L5, N5, U5, V5                                                                                                                                                                                                                                                                     | C10, E13, K11, L12, L13, L14, L15, M15                                                                                                                                                                                                                                                                                                             |
| V <sub>CCP</sub>  | E20, AW22                                                                                                                                                                                                                                                                                  | R5, T26                                                                                                                                                                                                                                                                                                                                            |
| V <sub>CCJ</sub>  | D3                                                                                                                                                                                                                                                                                         | B3                                                                                                                                                                                                                                                                                                                                                 |
| GND               | A1, A2, A20, A38, A39, AE3, AE37, AK3, AK37, AR36, AR4, AT20, AT35, AT5, AU10, AU14, AU20, AU26, AU30, AV1, AV2, AV20, AV38, AV39, AW1, AW2, AW20, AW38, AW39, B1, B2, B20, B38, B39, C10, C14, C20, C26, C30, D20, D35, D5, E36, E4, K3, K37, P37, R3, Y1, Y2, Y3, Y36, Y37, Y38, Y39, Y4 | A1, A2, A29, A30, AB28, AB3, AG27, AG4, AH22, AH28, AH3, AH9, AJ1, AJ2, AJ29, AJ30, AK1, AK2, AK29, AK30, B1, B2, B29, B30, C22, C28, C3, C9, D27, D4, J28, J3, N13, N14, N15, N16, N17, N18, P13, P14, P15, P16, P17, P18, R13, R14, R15, R16, R17, R18, T13, T14, T15, T16, T17, T18, U13, U14, U15, U16, U17, U18, V13, V14, V15, V16, V17, V18 |
| GND <sub>P</sub>  | AR20, A21                                                                                                                                                                                                                                                                                  | R28, T3                                                                                                                                                                                                                                                                                                                                            |

SELECTED DISCONTINUED

ispXPGA Power Supply and NC Connections<sup>1</sup> (Continued)

| Signal          | 680-Ball fpBGA <sup>3</sup>                                                                                                                                        | 900-Ball fpBGA <sup>3</sup>                                                                                                                                                                                                                                                                                                                                                                                                                                                                                                                                                                                                                                                                                                                                                                                                                                                                                                                                                                                                                                                                                                                                                                                                                                                                                                                                                                                                                                                                                                                                                                                                                                                                                                                                                                                                                                                                                                                                                                                                                                                                                                                                                                                                                                                                                                                                                                                                                                                                                                                                                                                                                                                                                                                                                                                                                                                                                                                                                                                                                                                                                                                                                                                                                              |
|-----------------|--------------------------------------------------------------------------------------------------------------------------------------------------------------------|----------------------------------------------------------------------------------------------------------------------------------------------------------------------------------------------------------------------------------------------------------------------------------------------------------------------------------------------------------------------------------------------------------------------------------------------------------------------------------------------------------------------------------------------------------------------------------------------------------------------------------------------------------------------------------------------------------------------------------------------------------------------------------------------------------------------------------------------------------------------------------------------------------------------------------------------------------------------------------------------------------------------------------------------------------------------------------------------------------------------------------------------------------------------------------------------------------------------------------------------------------------------------------------------------------------------------------------------------------------------------------------------------------------------------------------------------------------------------------------------------------------------------------------------------------------------------------------------------------------------------------------------------------------------------------------------------------------------------------------------------------------------------------------------------------------------------------------------------------------------------------------------------------------------------------------------------------------------------------------------------------------------------------------------------------------------------------------------------------------------------------------------------------------------------------------------------------------------------------------------------------------------------------------------------------------------------------------------------------------------------------------------------------------------------------------------------------------------------------------------------------------------------------------------------------------------------------------------------------------------------------------------------------------------------------------------------------------------------------------------------------------------------------------------------------------------------------------------------------------------------------------------------------------------------------------------------------------------------------------------------------------------------------------------------------------------------------------------------------------------------------------------------------------------------------------------------------------------------------------------------------|
| NC <sup>2</sup> | A3, B29, AW3, AV3, AW11, AV11, AV29, AW29, AW37, B3, AV37, C39, C38, AU39, AU38, AJ39, AJ38, N38, N39, C2, C1, AU1, AU2, AJ2, AJ1, N2, N1, B11, A11, A37, B37, A29 | <p><b>LFX500:</b> A8, A9, A10, A11, A19, A20, A21, A22, B8, B9, B10, B11, B19, B20, B21, B22, C1, C2, C11, C12, C19, C20, C23, D3, D10, D11, D12, D19, D20, D21, D22, D23, E3, E5, E6, E10, E11, E12, E21, E22, E25, E26, E28, E29, E30, F1, F2, F6, F9, F10, F11, F12, F21, F22, F25, F26, F29, F30, G1, G2, G3, G4, G7, G8, G9, G10, G11, G12, G14, G15, G16, G17, G19, G20, G21, G22, G23, G24, G25, G26, G27, G28, G29, G30, H1, H2, H3, H4, H5, H6, H7, H8, H9, H10, H11, H12, H13, H14, H15, H16, H17, H18, H19, H20, H21, H22, H23, H24, H27, H28, H29, H30, J1, J2, J4, J5, J6, J7, J8, J9, J10, J11, J12, J13, J14, J15, J16, J17, J18, J19, J20, J21, J22, J23, J24, J25, J26, J27, K6, K7, K8, K9, K10, K12, K13, K14, K15, K16, K17, K18, K19, K21, K22, K23, K24, K25, L7, L8, L9, L22, L23, L24, M7, M8, M9, M10, M21, M22, M23, M24, N8, N9, N10, N21, N22, N23, P7, P8, P9, P10, P21, P22, P23, P24, R8, R9, R10, R21, R22, R23, R24, R25, T6, T7, T8, T9, T10, T21, T22, T23, T24, T25, U7, U8, U9, U10, U21, U22, U23, U24, V8, V9, V10, V21, V22, V23, W7, W8, W9, W10, W21, W22, W23, W24, W25, W26, Y3, Y4, Y5, Y6, Y7, Y8, Y9, Y22, Y23, Y24, Y25, Y26, Y27, Y28, AA4, AA5, AA6, AA7, AA8, AA9, AA10, AA12, AA13, AA14, AA15, AA16, AA17, AA18, AA19, AA21, AA22, AA23, AA24, AA25, AA26, AA27, AB1, AB2, AB4, AB5, AB6, AB7, AB8, AB9, AB10, AB11, AB12, AB13, AB14, AB15, AB16, AB17, AB18, AB19, AB20, AB21, AB22, AB23, AB24, AB25, AB26, AB27, AC1, AC2, AC3, AC4, AC5, AC6, AC7, AC8, AC9, AC10, AC11, AC12, AC13, AC14, AC15, AC16, AC17, AC18, AC19, AC20, AC21, AC22, AC23, AC24, AC27, AC28, AC29, AC30, AD1, AD2, AD7, AD8, AD9, AD10, AD11, AD12, AD14, AD15, AD16, AD17, AD19, AD20, AD21, AD22, AD23, AD24, AD29, AD30, AE6, AE9, AE10, AE11, AE12, AE19, AE20, AE21, AE22, AE25, AE29, AE30, AF5, AF6, AF10, AF11, AF12, AF19, AF20, AF21, AF22, AF25, AF26, AG10, AG11, AG12, AG19, AG20, AG21, AG22, AH11, AH12, AH19, AH20, AJ8, AJ9, AJ10, AJ11, AJ20, AJ21, AJ22, AK8, AK9, AK10, AK11, AK20, AK21, AK22</p> <p><b>LFX1200:</b> AA22, AA23, AA24, AA25, AB23, AC24, T21, T22, T23, T24, T25, U21, U22, U23, U24, V21, V22, V23, W21, W22, W23, W24, Y22, Y23, Y24, AA16, AA17, AA18, AA19, AA21, AB16, AB17, AB18, AB19, AB20, AB21, AB22, AC16, AC17, AC18, AC19, AC20, AC21, AC22, AC23, AD16, AD17, AD19, AD20, AD22, AD23, AD24, AE22, AE25, AF25, AF26, AA10, AA12, AA13, AA14, AA15, AB10, AB11, AB12, AB13, AB14, AB15, AB9, AC10, AC11, AC12, AC13, AC14, AC15, AC8, AC9, AD11, AD12, AD14, AD15, AD7, AD8, AD9, AE6, AE9, AF5, AF6, H24, J23, K22, K23, K24, K25, L22, L23, L24, M21, M22, M23, M24, N21, N22, N23, P21, P22, P23, P24, R21, R22, R23, R24, R25, AA6, AA7, AA8, AA9, AB8, AC7, T10, T6, T7, T8, T9, U10, U7, U8, U9, V10, V8, V9, W10, W7, W8, W9, Y7, Y8, Y9, H5, H6, H7, J8, K6, K7, K8, K9, L7, L8, L9, M10, M7, M8, M9, N10, N8, N9, P10, P7, P8, P9, R10, R8, R9, E25, E26, F22, F25, G16, G17, G19, G20, G22, G23, G24, H16, H17, H18, H19, H20, H21, H22, H23, J16, J17, J18, J19, J20, J21, J22, K16, K17, K18, K19, K21, E5, E6, F6, F9, G11, G12, G14, G15, G7, G8, G9, H10, H11, H12, H13, H14, H15, H8, H9, J10, J11, J12, J13, J14, J15, J9, K10, K12, K13, K14, K15</p> |

1. All grounds must be electrically connected at the board level.
2. NC pins should not be connected to any active signals, V<sub>CC</sub> or GND.
3. Balls for GND, V<sub>CC</sub> and V<sub>CCOx</sub> are connected within the substrate to their respective common signals. Pin orientation A1 starts from the upper left corner of the top side view with alphabetical order ascending vertically and numerical order ascending horizontally.

**ispXPGA Logic Signal Connections: 256-Ball fpBGA**

| 256-fpBGA Ball | LFX200       |                 |                                        | LFX125       |                 |                                        |
|----------------|--------------|-----------------|----------------------------------------|--------------|-----------------|----------------------------------------|
|                | Signal Name  | Second Function | LVDS Pair/sysHSI Reserved <sup>2</sup> | Signal Name  | Second Function | LVDS Pair/sysHSI Reserved <sup>2</sup> |
| C2             | BK0_IO2      | HSI0A_SOUTP     | 1P/HSI0                                | BK0_IO0      | HSI0A_SOUTP     | 0P                                     |
| -              | GND (Bank 0) | -               | -                                      | -            | -               | -                                      |
| D2             | BK0_IO3      | HSI0A_SOUTN     | 1N/HSI0                                | BK0_IO1      | HSI0A_SOUTN     | 0N                                     |
| B1             | BK0_IO6      | HSI0A_SINP      | 3P/HSI0                                | BK0_IO4      | HSI0A_SINP      | 2P/HSI0                                |
| -              | -            | -               | -                                      | GND (Bank 0) | -               | -                                      |
| C1             | BK0_IO7      | HSI0A_SINN      | 3N/HSI0                                | BK0_IO5      | HSI0A_SINN      | 2N/HSI0                                |
| D3             | BK0_IO8      | -               | 4P/HSI0                                | BK0_IO6      | -               | 3P/HSI0                                |
| E3             | BK0_IO9      | VREF0           | 4N/HSI0                                | BK0_IO7      | VREF0           | 3N/HSI0                                |
| D1             | BK0_IO10     | HSI0B_SOUTP     | 5P/HSI0                                | BK0_IO8      | HSI0B_SOUTP     | 4P/HSI0                                |
| -              | GND (Bank 0) | -               | -                                      | -            | -               | -                                      |
| E1             | BK0_IO11     | HSI0B_SOUTN     | 5N/HSI0                                | BK0_IO9      | HSI0B_SOUTN     | 4N/HSI0                                |
| E2             | BK0_IO12     | -               | 6P/HSI0                                | BK0_IO10     | -               | 5P/HSI0                                |
| F2             | BK0_IO13     | -               | 6N/HSI0                                | BK0_IO11     | -               | 5N/HSI0                                |
| F1             | BK0_IO14     | HSI0B_SINP      | 7P/HSI0                                | BK0_IO12     | HSI0B_SINP      | 6P/HSI0                                |
| -              | -            | -               | -                                      | GND (Bank 0) | -               | -                                      |
| G1             | BK0_IO15     | HSI0B_SINN      | 7N/HSI0                                | BK0_IO13     | HSI0B_SINN      | 6N/HSI0                                |
| F3             | BK0_IO18     | PLL_FBK0        | 9P                                     | BK0_IO14     | PLL_FBK0        | 7P/HSI0                                |
| -              | GND (Bank 0) | -               | -                                      | -            | -               | -                                      |
| G2             | BK0_IO19     | PLL_RST1        | 9N                                     | BK0_IO15     | PLL_RST1        | 7N/HSI0                                |
| E4             | BK0_IO20     | -               | 10P                                    | BK0_IO16     | -               | 8P/HSI0                                |
| F4             | BK0_IO21     | PLL_FBK1        | 10N                                    | BK0_IO17     | PLL_FBK1        | 8N/HSI0                                |
| H1             | BK0_IO22     | PLL_RST0        | 11P                                    | BK0_IO18     | PLL_RST0        | 9P                                     |
| -              | -            | -               | -                                      | GND (Bank 0) | -               | -                                      |
| J1             | BK0_IO23     | -               | 11N                                    | BK0_IO19     | -               | 9N                                     |
| H2             | BK0_IO24     | CLK_OUT0        | 12P                                    | BK0_IO20     | CLK_OUT0        | 10P                                    |
| G3             | BK0_IO25     | CLK_OUT1        | 12N                                    | BK0_IO21     | CLK_OUT1        | 10N                                    |
| -              | GND (Bank 0) | -               | -                                      | -            | -               | -                                      |
| G4             | GCLK0        | -               | LVDS Pair0P                            | GCLK0        | -               | LVDS Pair0P                            |
| H4             | GCLK1        | -               | LVDS Pair0N                            | GCLK1        | -               | LVDS Pair0N                            |
| H3             | VCCP0        | -               | -                                      | VCCP0        | -               | -                                      |
| J4             | GNDP0        | -               | -                                      | GNDP0        | -               | -                                      |
| J2             | GCLK2        | -               | LVDS Pair1P                            | GCLK2        | -               | LVDS Pair1P                            |
| J3             | GCLK3        | -               | LVDS Pair1N                            | GCLK3        | -               | LVDS Pair1N                            |
| -              | GND (Bank 1) | -               | -                                      | -            | -               | -                                      |
| H5             | BK1_IO0      | CLK_OUT2        | 13P                                    | BK1_IO0      | CLK_OUT2        | 11P                                    |
| J5             | BK1_IO1      | CLK_OUT3        | 13N                                    | BK1_IO1      | CLK_OUT3        | 11N                                    |
| K1             | BK1_IO2      | SS_CLKOUT0P     | 14P                                    | BK1_IO2      | SS_CLKOUT0P     | 12P                                    |
| -              | -            | -               | -                                      | GND (Bank 1) | -               | -                                      |
| L1             | BK1_IO3      | SS_CLKOUT0N     | 14N                                    | BK1_IO3      | SS_CLKOUT0N     | 12N                                    |
| K4             | BK1_IO4      | PLL_FBK2        | 15P                                    | BK1_IO4      | PLL_FBK2        | 13P                                    |
| L4             | BK1_IO5      | PLL_FBK3        | 15N                                    | BK1_IO5      | PLL_FBK3        | 13N                                    |
| K3             | BK1_IO6      | SS_CLKIN0P      | 16P                                    | BK1_IO6      | SS_CLKIN0P      | 14P                                    |

**ispXPGA Logic Signal Connections: 256-Ball fpBGA (Cont.)**

| 256-fpBGA Ball | LFX200                |                 |                                            | LFX125                |                 |                                            |
|----------------|-----------------------|-----------------|--------------------------------------------|-----------------------|-----------------|--------------------------------------------|
|                | Signal Name           | Second Function | LVDS Pair/<br>sysHSI Reserved <sup>2</sup> | Signal Name           | Second Function | LVDS Pair/<br>sysHSI Reserved <sup>2</sup> |
| -              | GND (Bank 1)          | -               | -                                          | -                     | -               | -                                          |
| L3             | BK1_IO7               | SS_CLKIN0N      | 16N                                        | BK1_IO7               | SS_CLKIN0N      | 14N                                        |
| K2             | BK1_IO8               | -               | 17P                                        | BK1_IO8               | -               | 15P                                        |
| -              | -                     | -               | -                                          | GND (Bank 1)          | -               | -                                          |
| L2             | BK1_IO9               | -               | 17N                                        | BK1_IO9               | -               | 15N                                        |
| M1             | BK1_IO10              | HSI1A_SOUTP     | 18P/HSI1                                   | BK1_IO10              | -               | 16P                                        |
| N1             | BK1_IO11              | HSI1A_SOUTN     | 18N/HSI1                                   | BK1_IO11              | -               | 16N                                        |
| M3             | BK1_IO12              | PLL_RST2        | 19P/HSI1                                   | BK1_IO12              | PLL_RST2        | 17P                                        |
| M4             | BK1_IO13              | PLL_RST3        | 19N/HSI1                                   | BK1_IO13              | PLL_RST3        | 17N                                        |
| -              | GND (Bank 1)          | -               | -                                          | -                     | -               | -                                          |
| M2             | BK1_IO16 <sup>1</sup> | VREF1           | -                                          | BK1_IO14 <sup>1</sup> | VREF1           | -                                          |
| P1             | BK1_IO18              | HSI1B_SOUTP     | 22P/HSI1                                   | BK1_IO16              | -               | 19P                                        |
| -              | -                     | -               | -                                          | GND (Bank 1)          | -               | -                                          |
| R1             | BK1_IO19              | HSI1B_SOUTN     | 22N/HSI1                                   | BK1_IO17              | -               | 19N                                        |
| N3             | BK1_IO20 <sup>1</sup> | -               | -                                          | BK1_IO18 <sup>1</sup> | -               | -                                          |
| N2             | BK1_IO22              | HSI1B_SINP      | 24P/HSI1                                   | BK1_IO20              | -               | 21P                                        |
| -              | GND (Bank 1)          | -               | -                                          | -                     | -               | -                                          |
| P2             | BK1_IO23              | HSI1B_SINN      | 24N/HSI1                                   | BK1_IO21              | -               | 21N                                        |
| P4             | TCK                   | -               | -                                          | TCK                   | -               | -                                          |
| T2             | TMS                   | -               | -                                          | TMS                   | -               | -                                          |
| T3             | TOE                   | -               | -                                          | TOE                   | -               | -                                          |
| R3             | BK2_IO0               | -               | 26P                                        | BK2_IO0               | -               | 22P                                        |
| R4             | BK2_IO1               | -               | 26N                                        | BK2_IO1               | -               | 22N                                        |
| N5             | BK2_IO2               | -               | 27P                                        | BK2_IO2               | -               | 23P                                        |
| -              | GND (Bank 2)          | -               | -                                          | -                     | -               | -                                          |
| P5             | BK2_IO3               | -               | 27N                                        | BK2_IO3               | -               | 23N                                        |
| -              | -                     | -               | -                                          | GND (Bank 2)          | -               | -                                          |
| T4             | BK2_IO6               | -               | 29P                                        | BK2_IO6               | -               | 25P                                        |
| T5             | BK2_IO7               | -               | 29N                                        | BK2_IO7               | -               | 25N                                        |
| N6             | BK2_IO8               | -               | 30P                                        | BK2_IO8               | -               | 26P                                        |
| P6             | BK2_IO9               | VREF2           | 30N                                        | BK2_IO9               | VREF2           | 26N                                        |
| R5             | BK2_IO10              | -               | 31P                                        | BK2_IO10              | -               | 27P                                        |
| -              | GND (Bank 2)          | -               | -                                          | -                     | -               | -                                          |
| R6             | BK2_IO11              | -               | 31N                                        | BK2_IO11              | -               | 27N                                        |
| N7             | BK2_IO12              | -               | 32P                                        | BK2_IO12              | -               | 28P                                        |
| -              | -                     | -               | -                                          | GND (Bank 2)          | -               | -                                          |
| P7             | BK2_IO13              | -               | 32N                                        | BK2_IO13              | -               | 28N                                        |
| T6             | BK2_IO14              | -               | 33P                                        | BK2_IO14              | -               | 29P                                        |
| T7             | BK2_IO15              | -               | 33N                                        | BK2_IO15              | -               | 29N                                        |
| M8             | BK2_IO16              | -               | 34P                                        | BK2_IO16              | -               | 30P                                        |
| M9             | BK2_IO17              | -               | 34N                                        | BK2_IO17              | -               | 30N                                        |
| R7             | BK2_IO18              | -               | 35P                                        | BK2_IO18              | -               | 31P                                        |

**ispXPGA Logic Signal Connections: 256-Ball fpBGA (Cont.)**

| 256-fpBGA Ball | LFX200       |                 |                                         | LFX125       |                 |                                         |
|----------------|--------------|-----------------|-----------------------------------------|--------------|-----------------|-----------------------------------------|
|                | Signal Name  | Second Function | LVDS Pair/ sysHSI Reserved <sup>2</sup> | Signal Name  | Second Function | LVDS Pair/ sysHSI Reserved <sup>2</sup> |
| -              | GND (Bank 2) | -               | -                                       | GND (Bank 2) | -               | -                                       |
| R8             | BK2_IO19     | -               | 35N                                     | BK2_IO19     | -               | 31N                                     |
| N8             | BK2_IO20     | -               | 36P                                     | BK2_IO20     | -               | 32P                                     |
| P8             | BK2_IO21     | -               | 36N                                     | BK2_IO21     | -               | 32N                                     |
| -              | GND (Bank 2) | -               | -                                       | -            | -               | -                                       |
| -              | GND (Bank 3) | -               | -                                       | -            | -               | -                                       |
| T8             | BK3_IO0      | -               | 39P                                     | BK3_IO0      | -               | 33P                                     |
| T9             | BK3_IO1      | -               | 39N                                     | BK3_IO1      | -               | 33N                                     |
| R9             | BK3_IO2      | -               | 40P                                     | BK3_IO2      | -               | 34P                                     |
| -              | -            | -               | -                                       | GND (Bank 3) | -               | -                                       |
| R10            | BK3_IO3      | -               | 40N                                     | BK3_IO3      | -               | 34N                                     |
| P9             | BK3_IO4      | -               | 41P                                     | BK3_IO4      | -               | 35P                                     |
| N9             | BK3_IO5      | -               | 41N                                     | BK3_IO5      | -               | 35N                                     |
| T10            | BK3_IO6      | -               | 42P                                     | BK3_IO6      | -               | 36P                                     |
| -              | GND (Bank 3) | -               | -                                       | -            | -               | -                                       |
| T11            | BK3_IO7      | -               | 42N                                     | BK3_IO7      | -               | 36N                                     |
| P10            | BK3_IO8      | -               | 43P                                     | BK3_IO8      | -               | 37P                                     |
| -              | -            | -               | -                                       | GND (Bank 3) | -               | -                                       |
| N10            | BK3_IO9      | -               | 43N                                     | BK3_IO9      | -               | 37N                                     |
| R11            | BK3_IO14     | -               | 46P                                     | BK3_IO10     | -               | 38P                                     |
| -              | GND (Bank 3) | -               | -                                       | -            | -               | -                                       |
| R12            | BK3_IO15     | -               | 46N                                     | BK3_IO11     | -               | 38N                                     |
| P11            | BK3_IO16     | VREF3           | 47P                                     | BK3_IO12     | VREF3           | 39P                                     |
| N11            | BK3_IO17     | -               | 47N                                     | BK3_IO13     | -               | 39N                                     |
| T12            | BK3_IO18     | -               | 48P                                     | BK3_IO14     | -               | 40P                                     |
| T13            | BK3_IO19     | -               | 48N                                     | BK3_IO15     | -               | 40N                                     |
| R13            | BK3_IO20     | -               | 49P                                     | BK3_IO16     | -               | 41P                                     |
| -              | -            | -               | -                                       | GND (Bank 3) | -               | -                                       |
| R14            | BK3_IO21     | -               | 49N                                     | BK3_IO17     | -               | 41N                                     |
| P12            | BK3_IO22     | -               | 50P                                     | BK3_IO18     | -               | 42P                                     |
| -              | GND (Bank 3) | -               | -                                       | -            | -               | -                                       |
| N12            | BK3_IO23     | -               | 50N                                     | BK3_IO19     | -               | 42N                                     |
| T14            | GSR          | -               | -                                       | GSR          | -               | -                                       |
| T15            | DXP          | -               | -                                       | DXP          | -               | -                                       |
| P13            | DXN          | -               | -                                       | DXN          | -               | -                                       |
| P15            | BK4_IO0      | -               | 52P/HSI2                                | BK4_IO0      | -               | 44P                                     |
| N14            | BK4_IO1      | -               | 52N/HSI2                                | BK4_IO1      | -               | 44N                                     |
| R16            | BK4_IO2      | HSI2A_SINP      | 53P/HSI2                                | BK4_IO2      | -               | 45P                                     |
| -              | GND (Bank 4) | -               | -                                       | -            | -               | -                                       |
| P16            | BK4_IO3      | HSI2A_SINN      | 53N/HSI2                                | BK4_IO3      | -               | 45N                                     |
| N15            | BK4_IO4      | -               | 54P/HSI2                                | BK4_IO4      | -               | 46P                                     |
| -              | -            | -               | -                                       | GND (Bank 4) | -               | -                                       |

**ispXPGA Logic Signal Connections: 256-Ball fpBGA (Cont.)**

| 256-fpBGA Ball | LFX200       |                 |                                         | LFX125       |                 |                                         |
|----------------|--------------|-----------------|-----------------------------------------|--------------|-----------------|-----------------------------------------|
|                | Signal Name  | Second Function | LVDS Pair/ sysHSI Reserved <sup>2</sup> | Signal Name  | Second Function | LVDS Pair/ sysHSI Reserved <sup>2</sup> |
| M15            | BK4_IO5      | -               | 54N/HSI2                                | BK4_IO5      | -               | 46N                                     |
| M14            | BK4_IO8      | -               | 56P/HSI2                                | BK4_IO6      | -               | 47P                                     |
| M13            | BK4_IO9      | VREF4           | 56N/HSI2                                | BK4_IO7      | VREF4           | 47N                                     |
| -              | GND (Bank 4) | -               | -                                       | -            | -               | -                                       |
| L13            | BK4_IO12     | PLL_RST4        | 58P/HSI2                                | BK4_IO8      | PLL_RST4        | 48P                                     |
| L14            | BK4_IO13     | PLL_RST5        | 58N/HSI2                                | BK4_IO9      | PLL_RST5        | 48N                                     |
| N16            | BK4_IO14     | HSI2B_SOUTP     | 59P/HSI2                                | BK4_IO10     | -               | 49P                                     |
| M16            | BK4_IO15     | HSI2B_SOUTN     | 59N/HSI2                                | BK4_IO11     | -               | 49N                                     |
| -              | -            | -               | -                                       | GND (Bank 4) | -               | -                                       |
| L15            | BK4_IO18     | SS_CLKIN1P      | 61P                                     | BK4_IO14     | SS_CLKIN1P      | 51P                                     |
| -              | GND (Bank 4) | -               | -                                       | -            | -               | -                                       |
| K15            | BK4_IO19     | SS_CLKIN1N      | 61N                                     | BK4_IO15     | SS_CLKIN1N      | 51N                                     |
| K14            | BK4_IO20     | PLL_FBK4        | 62P                                     | BK4_IO16     | PLL_FBK4        | 52P                                     |
| K13            | BK4_IO21     | PLL_FBK5        | 62N                                     | BK4_IO17     | PLL_FBK5        | 52N                                     |
| L16            | BK4_IO22     | SS_CLKOUT1P     | 63P                                     | BK4_IO18     | SS_CLKOUT1P     | 53P                                     |
| -              | -            | -               | -                                       | GND (Bank 4) | -               | -                                       |
| K16            | BK4_IO23     | SS_CLKOUT1N     | 63N                                     | BK4_IO19     | SS_CLKOUT1N     | 53N                                     |
| J13            | BK4_IO24     | CLK_OUT4        | 64P                                     | BK4_IO20     | CLK_OUT4        | 54P                                     |
| J12            | BK4_IO25     | CLK_OUT5        | 64N                                     | BK4_IO21     | CLK_OUT5        | 54N                                     |
| -              | GND (Bank 4) | -               | -                                       | -            | -               | -                                       |
| J14            | GCLK4        | -               | LVDS Pair2P                             | GCLK4        | -               | LVDS Pair2P                             |
| H14            | GCLK5        | -               | LVDS Pair2N                             | GCLK5        | -               | LVDS Pair2N                             |
| J15            | VCCP1        | -               | -                                       | VCCP1        | -               | -                                       |
| H15            | GNDP1        | -               | -                                       | GNDP1        | -               | -                                       |
| J16            | GCLK6        | -               | LVDS Pair3P                             | GCLK6        | -               | LVDS Pair3P                             |
| H16            | GCLK7        | -               | LVDS Pair3N                             | GCLK7        | -               | LVDS Pair3N                             |
| -              | GND (Bank 5) | -               | -                                       | -            | -               | -                                       |
| H12            | BK5_IO0      | CLK_OUT6        | 65P                                     | BK5_IO0      | CLK_OUT6        | 55P                                     |
| H13            | BK5_IO1      | CLK_OUT7        | 65N                                     | BK5_IO1      | CLK_OUT7        | 55N                                     |
| G14            | BK5_IO2      | -               | 66P                                     | BK5_IO2      | -               | 56P                                     |
| -              | -            | -               | -                                       | GND (Bank 5) | -               | -                                       |
| G15            | BK5_IO3      | PLL_RST7        | 66N                                     | BK5_IO3      | PLL_RST7        | 56N                                     |
| G13            | BK5_IO6      | PLL_RST6        | 68P                                     | BK5_IO6      | PLL_RST6        | 58P/HSI1                                |
| -              | GND (Bank 5) | -               | -                                       | -            | -               | -                                       |
| F13            | BK5_IO7      | PLL_FBK7        | 68N                                     | BK5_IO7      | PLL_FBK7        | 58N/HSI1                                |
| G16            | BK5_IO10     | HSI3A_SINP      | 70P                                     | BK5_IO8      | HSI1A_SINP      | 59P/HSI1                                |
| -              | -            | -               | -                                       | GND (Bank 5) | -               | -                                       |
| F16            | BK5_IO11     | HSI3A_SINN      | 70N/HSI3                                | BK5_IO9      | HSI1A-SINN      | 59N/HSI1                                |
| F14            | BK5_IO12     | -               | 71P/HSI3                                | BK5_IO10     | -               | 60P/HSI1                                |
| F15            | BK5_IO13     | -               | 71N/HSI3                                | BK5_IO11     | -               | 60N/HSI1                                |
| E16            | BK5_IO14     | HSI3A_SOUTP     | 72P/HSI3                                | BK5_IO12     | HSI1A_SOUTP     | 61P/HSI1                                |
| -              | GND (Bank 5) | -               | -                                       | -            | -               | -                                       |



ispXPGA Logic Signal Connections: 256-Ball fpBGA (Cont.)

| 256-fpBGA Ball | LFX200       |                 |                                         | LFX125       |                 |                                         |
|----------------|--------------|-----------------|-----------------------------------------|--------------|-----------------|-----------------------------------------|
|                | Signal Name  | Second Function | LVDS Pair/ sysHSI Reserved <sup>2</sup> | Signal Name  | Second Function | LVDS Pair/ sysHSI Reserved <sup>2</sup> |
| D16            | BK5_IO15     | HSI3A_SOUTN     | 72N/HSI3                                | BK5_IO13     | HSI1A_SOUTN     | 61N/HSI1                                |
| E13            | BK5_IO16     | VREF5           | 73P/HSI3                                | BK5_IO14     | VREF5           | 62P/HSI1                                |
| E14            | BK5_IO17     | -               | 73N/HSI3                                | BK5_IO15     | -               | 62N/HSI1                                |
| E15            | BK5_IO18     | HSI3B_SINP      | 74P/HSI3                                | BK5_IO16     | HSI1B_SINP      | 63P/HSI1                                |
| -              | -            | -               | -                                       | GND (Bank 5) | -               | -                                       |
| D15            | BK5_IO19     | HSI3B_SINN      | 74N/HSI3                                | BK5_IO17     | HSI1B_SINN      | 63N/HSI1                                |
| C16            | BK5_IO22     | HSI3B_SOUTP     | 76P/HSI3                                | BK5_IO20     | HSI1B_SOUTP     | 65P/HSI1                                |
| -              | GND (Bank 5) | -               | -                                       | -            | -               | -                                       |
| B16            | BK5_IO23     | HSI3B_SOUTN     | 76N/HSI3                                | BK5_IO21     | HSI1B_SOUTN     | 65N/HSI1                                |
| D14            | BK5_IO24     | -               | 77P/HSI3                                | BK5_IO18     | -               | 64P/HSI1                                |
| C15            | BK5_IO25     | -               | 77N/HSI3                                | BK5_IO19     | -               | 64N/HSI1                                |
| C13            | CFG0         | -               | -                                       | CFG0         | -               | -                                       |
| A15            | DONE         | -               | -                                       | DONE         | -               | -                                       |
| A14            | PROGRAMb     | -               | -                                       | PROGRAMb     | -               | -                                       |
| D12            | BK6_IO0      | INITb           | 78P                                     | BK6_IO0      | INITb           | 66P                                     |
| C12            | BK6_IO1      | CCLK            | 78N                                     | BK6_IO1      | CCLK            | 66N                                     |
| B14            | BK6_IO2      | -               | 79P                                     | BK6_IO2      | -               | 67P                                     |
| -              | GND (Bank 6) | -               | -                                       | -            | -               | -                                       |
| B13            | BK6_IO3      | -               | 79N                                     | BK6_IO3      | -               | 67N                                     |
| A13            | BK6_IO4      | CSb             | 80P                                     | BK6_IO4      | CSb             | 68P                                     |
| -              | -            | -               | -                                       | GND (Bank 6) | -               | -                                       |
| A12            | BK6_IO5      | Read            | 80N                                     | BK6_IO5      | READ            | 68N                                     |
| D11            | BK6_IO6      | DATA7           | 81P                                     | BK6_IO6      | DATA7           | 69P                                     |
| C11            | BK6_IO7      | DATA6           | 81N                                     | BK6_IO7      | DATA6           | 69N                                     |
| B12            | BK6_IO8      | -               | 82P                                     | BK6_IO8      | -               | 70P                                     |
| B11            | BK6_IO9      | VREF6           | 82N                                     | BK6_IO9      | VREF6           | 70N                                     |
| D10            | BK6_IO10     | DATA5           | 83P                                     | BK6_IO10     | DATA5           | 71P                                     |
| -              | GND (Bank 6) | -               | -                                       | -            | -               | -                                       |
| C10            | BK6_IO11     | DATA4           | 83N                                     | BK6_IO11     | DATA4           | 71N                                     |
| -              | -            | -               | -                                       | GND (Bank 6) | -               | -                                       |
| A11            | BK6_IO14     | DATA3           | 85P                                     | BK6_IO14     | DATA3           | 73P                                     |
| A10            | BK6_IO15     | DATA2           | 85N                                     | BK6_IO15     | DATA2           | 73N                                     |
| D9             | BK6_IO16     | -               | 86P                                     | BK6_IO16     | -               | 74P                                     |
| C9             | BK6_IO17     | -               | 86N                                     | BK6_IO17     | -               | 74N                                     |
| B10            | BK6_IO18     | DATA1           | 87P                                     | BK6_IO18     | DATA1           | 75P                                     |
| -              | GND (Bank 6) | -               | -                                       | GND (Bank 6) | -               | -                                       |
| B9             | BK6_IO19     | DATA0           | 87N                                     | BK6_IO19     | DATA0           | 75N                                     |
| E9             | BK6_IO20     | -               | 88P                                     | BK6_IO20     | -               | 76P                                     |
| E8             | BK6_IO21     | -               | 88N                                     | BK6_IO21     | -               | 76N                                     |
| -              | GND (Bank 6) | -               | -                                       | -            | -               | -                                       |
| -              | GND (Bank 7) | -               | -                                       | -            | -               | -                                       |
| D8             | BK7_IO0      | -               | 91P                                     | BK7_IO0      | -               | 77P                                     |

**ispXPGA Logic Signal Connections: 256-Ball fpBGA (Cont.)**

| 256-fpBGA Ball | LFX200       |                 |                                            | LFX125       |                 |                                            |
|----------------|--------------|-----------------|--------------------------------------------|--------------|-----------------|--------------------------------------------|
|                | Signal Name  | Second Function | LVDS Pair/<br>sysHSI Reserved <sup>2</sup> | Signal Name  | Second Function | LVDS Pair/<br>sysHSI Reserved <sup>2</sup> |
| C8             | BK7_IO1      | -               | 91N                                        | BK7_IO1      | -               | 77N                                        |
| B8             | BK7_IO2      | -               | 92P                                        | BK7_IO2      | -               | 78P                                        |
| B7             | BK7_IO3      | -               | 92N                                        | BK7_IO3      | -               | 78N                                        |
| A9             | BK7_IO6      | -               | 94P                                        | BK7_IO4      | -               | 79P                                        |
| -              | GND (Bank 7) | -               | -                                          | -            | -               | -                                          |
| A8             | BK7_IO7      | -               | 94N                                        | BK7_IO5      | -               | 79N                                        |
| C7             | BK7_IO10     | -               | 96P                                        | BK7_IO6      | -               | 80P                                        |
| D7             | BK7_IO11     | -               | 96N                                        | BK7_IO7      | -               | 80N                                        |
| D6             | BK7_IO12     | -               | 97P                                        | BK7_IO8      | -               | 81P                                        |
| -              | -            | -               | -                                          | GND (Bank 7) | -               | -                                          |
| C6             | BK7_IO13     | -               | 97N                                        | BK7_IO9      | -               | 81N                                        |
| B6             | BK7_IO14     | -               | 98P                                        | BK7_IO10     | -               | 82P                                        |
| -              | GND (Bank 7) | -               | -                                          | -            | -               | -                                          |
| B5             | BK7_IO15     | -               | 98N                                        | BK7_IO11     | -               | 82N                                        |
| A7             | BK7_IO16     | VREF7           | 99P                                        | BK7_IO12     | VREF7           | 83P                                        |
| A6             | BK7_IO17     | -               | 99N                                        | BK7_IO13     | -               | 83N                                        |
| D5             | BK7_IO18     | -               | 100P                                       | BK7_IO14     | -               | 84P                                        |
| C5             | BK7_IO19     | -               | 100N                                       | BK7_IO15     | -               | 84N                                        |
| A5             | BK7_IO20     | -               | 101P                                       | BK7_IO16     | -               | 85P                                        |
| -              | -            | -               | -                                          | GND (Bank 7) | -               | -                                          |
| A4             | BK7_IO21     | -               | 101N                                       | BK7_IO17     | -               | 85N                                        |
| B4             | BK7_IO22     | -               | 102P                                       | BK7_IO18     | -               | 86P                                        |
| -              | GND (Bank 7) | -               | -                                          | -            | -               | -                                          |
| B3             | BK7_IO23     | -               | 102N                                       | BK7_IO19     | -               | 86N                                        |
| A3             | TDO          | -               | -                                          | TDO          | -               | -                                          |
| A2             | VCCJ         | -               | -                                          | VCCJ         | -               | -                                          |
| C4             | TDI          | -               | -                                          | TDI          | -               | -                                          |

1. Not available for differential pairs.  
 2. If a sysHSI Block is used, the indicated sysHSI reserved pins are unavailable for general purpose I/O use.

ispXPGA Logic Signal Connections: 516-Ball fpBGA

| 516-Ball BGA Ball | LFX500       |                 |                                        | LFX200       |                 |                                        | LFX125       |                 |                                        |
|-------------------|--------------|-----------------|----------------------------------------|--------------|-----------------|----------------------------------------|--------------|-----------------|----------------------------------------|
|                   | Signal Name  | Second Function | LVDS Pair/sysHSI Reserved <sup>1</sup> | Signal Name  | Second Function | LVDS Pair/sysHSI Reserved <sup>1</sup> | Signal Name  | Second Function | LVDS Pair/sysHSI Reserved <sup>1</sup> |
| E4                | BK0_IO0      | -               | 0P                                     | BK0_IO0      | -               | 0P/HSIO                                | NC           | -               | -                                      |
| D3                | BK0_IO1      | -               | 0N                                     | BK0_IO1      | -               | 0N/HSIO                                | NC           | -               | -                                      |
| E3                | BK0_IO2      | HSIOA_SOUTP     | 1P/HSIO                                | BK0_IO2      | HSIOA_SOUTP     | 1P/HSIO                                | BK0_IO0      | HSIOA_SOUTP     | 0P                                     |
| -                 | GND (Bank 0) | -               | -                                      | GND (Bank 0) | -               | -                                      | -            | -               | -                                      |
| F3                | BK0_IO3      | HSIOA_SOUTN     | 1N/HSIO                                | BK0_IO3      | HSIOA_SOUTN     | 1N/HSIO                                | BK0_IO1      | HSIOA_SOUTN     | 0N                                     |
| C2                | BK0_IO4      | -               | 2P/HSIO                                | BK0_IO4      | -               | 2P/HSIO                                | BK0_IO2      | -               | 1P/HSIO                                |
| B1                | BK0_IO5      | -               | 2N/HSIO                                | BK0_IO5      | -               | 2N/HSIO                                | BK0_IO3      | -               | 1N/HSIO                                |
| G4                | BK0_IO6      | HSIOA_SINP      | 3P/HSIO                                | BK0_IO6      | HSIOA_SINP      | 3P/HSIO                                | BK0_IO4      | HSIOA_SINP      | 2P/HSIO                                |
| -                 | -            | -               | -                                      | -            | -               | -                                      | GND (Bank 0) | -               | -                                      |
| G3                | BK0_IO7      | HSIOA_SINN      | 3N/HSIO                                | BK0_IO7      | HSIOA_SINN      | 3N/HSIO                                | BK0_IO5      | HSIOA_SINN      | 2N/HSIO                                |
| C1                | BK0_IO8      | -               | 4P/HSIO                                | BK0_IO8      | -               | 4P/HSIO                                | BK0_IO6      | -               | 3P/HSIO                                |
| D2                | BK0_IO9      | VREF0           | 4N/HSIO                                | BK0_IO9      | VREF0           | 4N/HSIO                                | BK0_IO7      | VREF0           | 3N/HSIO                                |
| H4                | BK0_IO10     | HSIOB_SOUTP     | 5P/HSIO                                | BK0_IO10     | HSIOB_SOUTP     | 5P/HSIO                                | BK0_IO8      | HSIOB_SOUTP     | 4P/HSIO                                |
| -                 | GND (Bank 0) | -               | -                                      | GND (Bank 0) | -               | -                                      | -            | -               | -                                      |
| H3                | BK0_IO11     | HSIOB_SOUTN     | 5N/HSIO                                | BK0_IO11     | HSIOB_SOUTN     | 5N/HSIO                                | BK0_IO9      | HSIOB_SOUTN     | 4N/HSIO                                |
| D1                | BK0_IO12     | -               | 6P/HSIO                                | BK0_IO12     | -               | 6P/HSIO                                | BK0_IO10     | -               | 5P/HSIO                                |
| E1                | BK0_IO13     | -               | 6N/HSIO                                | BK0_IO13     | -               | 6N/HSIO                                | BK0_IO11     | -               | 5N/HSIO                                |
| E2                | BK0_IO14     | HSIOB_SINP      | 7P/HSIO                                | BK0_IO14     | HSIOB_SINP      | 7P/HSIO                                | BK0_IO12     | HSIOB_SINP      | 6P/HSIO                                |
| -                 | -            | -               | -                                      | -            | -               | -                                      | GND (Bank 0) | -               | -                                      |
| F2                | BK0_IO15     | HSIOB_SINN      | 7N/HSIO                                | BK0_IO15     | HSIOB_SINN      | 7N/HSIO                                | BK0_IO13     | HSIOB_SINN      | 6N/HSIO                                |
| G2                | BK0_IO16     | -               | 8P/HSIO                                | NC           | -               | -                                      | NC           | -               | -                                      |
| F1                | BK0_IO17     | -               | 8N/HSIO                                | NC           | -               | -                                      | NC           | -               | -                                      |
| J3                | BK0_IO18     | HSI1A_SOUTP     | 9P                                     | NC           | -               | -                                      | NC           | -               | -                                      |
| -                 | GND (Bank 0) | -               | -                                      | -            | -               | -                                      | -            | -               | -                                      |
| K3                | BK0_IO19     | HSI1A_SOUTN     | 9N                                     | NC           | -               | -                                      | NC           | -               | -                                      |
| K4                | BK0_IO20     | -               | 10P                                    | NC           | -               | -                                      | NC           | -               | -                                      |
| L4                | BK0_IO21     | -               | 10N                                    | NC           | -               | -                                      | NC           | -               | -                                      |
| H2                | BK0_IO22     | HSI1A_SINP      | 11P                                    | NC           | -               | -                                      | NC           | -               | -                                      |
| J2                | BK0_IO23     | HSI1A_SINN      | 11N                                    | NC           | -               | -                                      | NC           | -               | -                                      |
| G1                | BK0_IO24     | -               | 12P                                    | NC           | -               | -                                      | NC           | -               | -                                      |
| H1                | BK0_IO25     | -               | 12N                                    | NC           | -               | -                                      | NC           | -               | -                                      |
| L3                | BK0_IO26     | HSI1B_SOUTP     | 13P                                    | NC           | -               | -                                      | NC           | -               | -                                      |
| -                 | GND (Bank 0) | -               | -                                      | -            | -               | -                                      | -            | -               | -                                      |
| M3                | BK0_IO27     | HSI1B_SOUTN     | 13N                                    | NC           | -               | -                                      | NC           | -               | -                                      |
| K2                | BK0_IO28     | -               | 14P                                    | NC           | -               | -                                      | NC           | -               | -                                      |
| L2                | BK0_IO29     | -               | 14N                                    | NC           | -               | -                                      | NC           | -               | -                                      |
| K1                | BK0_IO30     | HSI1B_SINP      | 15P                                    | NC           | -               | -                                      | NC           | -               | -                                      |
| L1                | BK0_IO31     | HSI1B_SINN      | 15N                                    | NC           | -               | -                                      | NC           | -               | -                                      |
| M2                | BK0_IO32     | -               | 16P                                    | BK0_IO16     | -               | 8P                                     | NC           | -               | -                                      |
| M1                | BK0_IO33     | -               | 16N                                    | BK0_IO17     | -               | 8N                                     | NC           | -               | -                                      |
| N3                | BK0_IO34     | PLL_FBK0        | 17P                                    | BK0_IO18     | PLL_FBK0        | 9P                                     | BK0_IO14     | PLL_FBK0        | 7P/HSIO                                |
| -                 | GND (Bank 0) | -               | -                                      | GND (Bank 0) | -               | -                                      | -            | -               | -                                      |
| N4                | BK0_IO35     | PLL_RST1        | 17N                                    | BK0_IO19     | PLL_RST1        | 9N                                     | BK0_IO15     | PLL_RST1        | 7N/HSIO                                |
| N2                | BK0_IO36     | -               | 18P                                    | BK0_IO20     | -               | 10P                                    | BK0_IO16     | -               | 8P/HSIO                                |
| N1                | BK0_IO37     | PLL_FBK1        | 18N                                    | BK0_IO21     | PLL_FBK1        | 10N                                    | BK0_IO17     | PLL_FBK1        | 8N/HSIO                                |
| P1                | BK0_IO38     | PLL_RST0        | 19P                                    | BK0_IO22     | PLL_RST0        | 11P                                    | BK0_IO18     | PLL_RST0        | 9P                                     |
| -                 | -            | -               | -                                      | -            | -               | -                                      | GND (Bank 0) | -               | -                                      |
| R1                | BK0_IO39     | -               | 19N                                    | BK0_IO23     | -               | 11N                                    | BK0_IO19     | -               | 9N                                     |
| P3                | BK0_IO40     | CLK_OUT0        | 20P                                    | BK0_IO24     | CLK_OUT0        | 12P                                    | BK0_IO20     | CLK_OUT0        | 10P                                    |
| -                 | GND (Bank 0) | -               | -                                      | -            | -               | -                                      | -            | -               | -                                      |
| P2                | BK0_IO41     | CLK_OUT1        | 20N                                    | BK0_IO25     | CLK_OUT1        | 12N                                    | BK0_IO21     | CLK_OUT1        | 10N                                    |

ispXPGA Logic Signal Connections: 516-Ball fpBGA (Cont.)

| 516-Ball BGA Ball | LFX500       |                 |                                         | LFX200       |                 |                                         | LFX125       |                 |                                         |
|-------------------|--------------|-----------------|-----------------------------------------|--------------|-----------------|-----------------------------------------|--------------|-----------------|-----------------------------------------|
|                   | Signal Name  | Second Function | LVDS Pair/ sysHSI Reserved <sup>1</sup> | Signal Name  | Second Function | LVDS Pair/ sysHSI Reserved <sup>1</sup> | Signal Name  | Second Function | LVDS Pair/ sysHSI Reserved <sup>1</sup> |
| -                 | -            | -               | -                                       | GND (Bank 0) | -               | -                                       | -            | -               | -                                       |
| R2                | GCLK0        | -               | LVDS Pair0P                             | GCLK0        | -               | LVDS Pair0P                             | GCLK0        | -               | LVDS Pair0P                             |
| R3                | GCLK1        | -               | LVDS Pair0N                             | GCLK1        | -               | LVDS Pair0N                             | GCLK1        | -               | LVDS Pair0N                             |
| R4                | VCCP0        | -               | -                                       | VCCP0        | -               | -                                       | VCCP0        | -               | -                                       |
| T4                | GNDP0        | -               | -                                       | GNDP0        | -               | -                                       | GNDP0        | -               | -                                       |
| T3                | GCLK2        | -               | LVDS Pair1P                             | GCLK2        | -               | LVDS Pair1P                             | GCLK2        | -               | LVDS Pair1P                             |
| T2                | GCLK3        | -               | LVDS Pair1N                             | GCLK3        | -               | LVDS Pair1N                             | GCLK3        | -               | LVDS Pair1N                             |
| -                 | -            | -               | -                                       | GND (Bank 1) | -               | -                                       | -            | -               | -                                       |
| T1                | BK1_IO0      | CLK_OUT2        | 21P                                     | BK1_IO0      | CLK_OUT2        | 13P                                     | BK1_IO0      | CLK_OUT2        | 11P                                     |
| -                 | GND (Bank 1) | -               | -                                       | -            | -               | -                                       | -            | -               | -                                       |
| U1                | BK1_IO1      | CLK_OUT3        | 21N                                     | BK1_IO1      | CLK_OUT3        | 13N                                     | BK1_IO1      | CLK_OUT3        | 11N                                     |
| U2                | BK1_IO2      | SS_CLKOUT0P     | 22P                                     | BK1_IO2      | SS_CLKOUT0P     | 14P                                     | BK1_IO2      | SS_CLKOUT0P     | 12P                                     |
| -                 | -            | -               | -                                       | -            | -               | -                                       | GND (Bank 1) | -               | -                                       |
| U3                | BK1_IO3      | SS_CLKOUT0N     | 22N                                     | BK1_IO3      | SS_CLKOUT0N     | 14N                                     | BK1_IO3      | SS_CLKOUT0N     | 12N                                     |
| V1                | BK1_IO4      | PLL_FBK2        | 23P                                     | BK1_IO4      | PLL_FBK2        | 15P                                     | BK1_IO4      | PLL_FBK2        | 13P                                     |
| V2                | BK1_IO5      | PLL_FBK3        | 23N                                     | BK1_IO5      | PLL_FBK3        | 15N                                     | BK1_IO5      | PLL_FBK3        | 13N                                     |
| V3                | BK1_IO6      | -               | 24P                                     | NC           | -               | -                                       | NC           | -               | -                                       |
| -                 | GND (Bank 1) | -               | -                                       | -            | -               | -                                       | -            | -               | -                                       |
| V4                | BK1_IO7      | -               | 24N                                     | NC           | -               | -                                       | NC           | -               | -                                       |
| W1                | BK1_IO8      | -               | 25P                                     | NC           | -               | -                                       | NC           | -               | -                                       |
| Y1                | BK1_IO9      | -               | 25N                                     | NC           | -               | -                                       | NC           | -               | -                                       |
| W2                | BK1_IO10     | SS_CLKIN0P      | 26P                                     | BK1_IO6      | SS_CLKIN0P      | 16P                                     | BK1_IO6      | SS_CLKIN0P      | 14P                                     |
| -                 | -            | -               | -                                       | GND (Bank 1) | -               | -                                       | -            | -               | -                                       |
| W3                | BK1_IO11     | SS_CLKIN0N      | 26N                                     | BK1_IO7      | SS_CLKIN0N      | 16N                                     | BK1_IO7      | SS_CLKIN0N      | 14N                                     |
| Y2                | BK1_IO12     | -               | 27P                                     | BK1_IO8      | -               | 17P                                     | BK1_IO8      | -               | 15P                                     |
| -                 | -            | -               | -                                       | -            | -               | -                                       | GND (Bank 1) | -               | -                                       |
| Y4                | BK1_IO13     | -               | 27N                                     | BK1_IO9      | -               | 17N                                     | BK1_IO9      | -               | 15N                                     |
| Y3                | BK1_IO14     | -               | 28P                                     | NC           | -               | -                                       | NC           | -               | -                                       |
| -                 | GND (Bank 1) | -               | -                                       | -            | -               | -                                       | -            | -               | -                                       |
| AA1               | BK1_IO15     | -               | 28N                                     | NC           | -               | -                                       | NC           | -               | -                                       |
| AA2               | BK1_IO16     | -               | 29P                                     | NC           | -               | -                                       | NC           | -               | -                                       |
| AA3               | BK1_IO17     | -               | 29N                                     | NC           | -               | -                                       | NC           | -               | -                                       |
| AB2               | BK1_IO18     | HSI2A_SOUTP     | 30P                                     | BK1_IO10     | HSI1A_SOUTP     | 18P/HSI1                                | BK1_IO10     | -               | 16P                                     |
| AC2               | BK1_IO19     | HSI2A_SOUTN     | 30N                                     | BK1_IO11     | HSI1A_SOUTN     | 18N/HSI1                                | BK1_IO11     | -               | 16N                                     |
| AB3               | BK1_IO20     | PLL_RST2        | 31P                                     | BK1_IO12     | PLL_RST2        | 19P/HSI1                                | BK1_IO12     | PLL_RST2        | 17P                                     |
| AA4               | BK1_IO21     | PLL_RST3        | 31N                                     | BK1_IO13     | PLL_RST3        | 19N/HSI1                                | BK1_IO13     | PLL_RST3        | 17N                                     |
| AC1               | BK1_IO22     | HSI2A_SINP      | 32P                                     | BK1_IO14     | HSI1A_SINP      | 20P/HSI1                                | NC           | -               | -                                       |
| -                 | GND (Bank 1) | -               | -                                       | GND (Bank 1) | -               | -                                       | -            | -               | -                                       |
| AD1               | BK1_IO23     | HSI2A_SINN      | 32N                                     | BK1_IO15     | HSI1A_SINN      | 20N/HSI1                                | NC           | -               | -                                       |
| AE1               | BK1_IO24     | VREF1           | 33P/HSI2                                | BK1_IO16     | VREF1           | 21P/HSI1                                | BK1_IO14     | VREF1           | 18P                                     |
| AF1               | BK1_IO25     | -               | 33N/HSI2                                | BK1_IO17     | -               | 21N/HSI1                                | BK1_IO15     | -               | 18N                                     |
| AC3               | BK1_IO26     | HSI2B_SOUTP     | 34P/HSI2                                | BK1_IO18     | HSI1B_SOUTP     | 22P/HSI1                                | BK1_IO16     | -               | 19P                                     |
| -                 | -            | -               | -                                       | -            | -               | -                                       | GND (Bank 1) | -               | -                                       |
| AC4               | BK1_IO27     | HSI2B_SOUTN     | 34N/HSI2                                | BK1_IO19     | HSI1B_SOUTN     | 22N/HSI1                                | BK1_IO17     | -               | 19N                                     |
| AD2               | BK1_IO28     | -               | 35P/HSI2                                | BK1_IO20     | -               | 23P/HSI1                                | BK1_IO18     | -               | 20P                                     |
| AD3               | BK1_IO29     | -               | 35N/HSI2                                | BK1_IO21     | -               | 23N/HSI1                                | BK1_IO19     | -               | 20N                                     |
| AE2               | BK1_IO30     | HSI2B_SINP      | 36P/HSI2                                | BK1_IO22     | HSI1B_SINP      | 24P/HSI1                                | BK1_IO20     | -               | 21P                                     |
| -                 | GND (Bank 1) | -               | -                                       | GND (Bank 1) | -               | -                                       | -            | -               | -                                       |
| AF2               | BK1_IO31     | HSI2B_SINN      | 36N/HSI2                                | BK1_IO23     | HSI1B_SINN      | 24N/HSI1                                | BK1_IO21     | -               | 21N                                     |
| AD4               | BK1_IO32     | -               | 37P/HSI2                                | NC           | -               | -                                       | NC           | -               | -                                       |

ispXPGA Logic Signal Connections: 516-Ball fpBGA (Cont.)

| 516-Ball BGA Ball | LFX500       |                 |                                         | LFX200       |                 |                                         | LFX125       |                 |                                         |
|-------------------|--------------|-----------------|-----------------------------------------|--------------|-----------------|-----------------------------------------|--------------|-----------------|-----------------------------------------|
|                   | Signal Name  | Second Function | LVDS Pair/ sysHSI Reserved <sup>1</sup> | Signal Name  | Second Function | LVDS Pair/ sysHSI Reserved <sup>1</sup> | Signal Name  | Second Function | LVDS Pair/ sysHSI Reserved <sup>1</sup> |
| AE3               | BK1_IO33     | -               | 37N/HSI2                                | NC           | -               | -                                       | NC           | -               | -                                       |
| AG1               | BK1_IO34     | -               | 38P/HSI2                                | NC           | -               | -                                       | NC           | -               | -                                       |
| AH1               | BK1_IO35     | -               | 38N/HSI2                                | NC           | -               | -                                       | NC           | -               | -                                       |
| AG2               | BK1_IO36     | -               | 39P/HSI2                                | NC           | -               | -                                       | NC           | -               | -                                       |
| AF3               | BK1_IO37     | -               | 39N/HSI2                                | NC           | -               | -                                       | NC           | -               | -                                       |
| AJ1               | BK1_IO38     | -               | 40P/HSI2                                | NC           | -               | -                                       | NC           | -               | -                                       |
| -                 | GND (Bank 1) | -               | -                                       | -            | -               | -                                       | -            | -               | -                                       |
| AH2               | BK1_IO39     | -               | 40N/HSI2                                | NC           | -               | -                                       | NC           | -               | -                                       |
| AG3               | BK1_IO40     | -               | 41P                                     | BK1_IO24     | -               | 25P/HSI1                                | NC           | -               | -                                       |
| AF4               | BK1_IO41     | -               | 41N                                     | BK1_IO25     | -               | 25N/HSI1                                | NC           | -               | -                                       |
| AK2               | TCK          | -               | -                                       | TCK          | -               | -                                       | TCK          | -               | -                                       |
| AJ3               | TMS          | -               | -                                       | TMS          | -               | -                                       | TMS          | -               | -                                       |
| AG5               | TOE          | -               | -                                       | TOE          | -               | -                                       | TOE          | -               | -                                       |
| AH4               | BK2_IO0      | -               | 42P                                     | BK2_IO0      | -               | 26P                                     | BK2_IO0      | -               | 22P                                     |
| AK3               | BK2_IO1      | -               | 42N                                     | BK2_IO1      | -               | 26N                                     | BK2_IO1      | -               | 22N                                     |
| AJ4               | BK2_IO2      | -               | 43P                                     | BK2_IO2      | -               | 27P                                     | BK2_IO2      | -               | 23P                                     |
| -                 | GND (Bank 2) | -               | -                                       | GND (Bank 2) | -               | -                                       | -            | -               | -                                       |
| AH5               | BK2_IO3      | -               | 43N                                     | BK2_IO3      | -               | 27N                                     | BK2_IO3      | -               | 23N                                     |
| AK4               | BK2_IO4      | -               | 44P                                     | BK2_IO4      | -               | 28P                                     | BK2_IO4      | -               | 24P                                     |
| -                 | -            | -               | -                                       | -            | -               | -                                       | GND (Bank 2) | -               | -                                       |
| AJ5               | BK2_IO5      | -               | 44N                                     | BK2_IO5      | -               | 28N                                     | BK2_IO5      | -               | 24N                                     |
| AG7               | BK2_IO6      | -               | 45P                                     | BK2_IO6      | -               | 29P                                     | BK2_IO6      | -               | 25P                                     |
| AH6               | BK2_IO7      | -               | 45N                                     | BK2_IO7      | -               | 29N                                     | BK2_IO7      | -               | 25N                                     |
| AK5               | BK2_IO8      | -               | 46P                                     | NC           | -               | -                                       | NC           | -               | -                                       |
| AJ6               | BK2_IO9      | -               | 46N                                     | NC           | -               | -                                       | NC           | -               | -                                       |
| AG8               | BK2_IO10     | -               | 47P                                     | NC           | -               | -                                       | NC           | -               | -                                       |
| -                 | GND (Bank 2) | -               | -                                       | -            | -               | -                                       | -            | -               | -                                       |
| AH7               | BK2_IO11     | -               | 47N                                     | NC           | -               | -                                       | NC           | -               | -                                       |
| AK6               | BK2_IO12     | -               | 48P                                     | NC           | -               | -                                       | NC           | -               | -                                       |
| AJ7               | BK2_IO13     | -               | 48N                                     | NC           | -               | -                                       | NC           | -               | -                                       |
| AH8               | BK2_IO14     | -               | 49P                                     | NC           | -               | -                                       | NC           | -               | -                                       |
| AG10              | BK2_IO15     | -               | 49N                                     | NC           | -               | -                                       | NC           | -               | -                                       |
| AK7               | BK2_IO16     | -               | 50P                                     | NC           | -               | -                                       | NC           | -               | -                                       |
| AJ8               | BK2_IO17     | -               | 50N                                     | NC           | -               | -                                       | NC           | -               | -                                       |
| AH9               | BK2_IO18     | -               | 51P                                     | NC           | -               | -                                       | NC           | -               | -                                       |
| -                 | GND (Bank 2) | -               | -                                       | -            | -               | -                                       | -            | -               | -                                       |
| AG11              | BK2_IO19     | -               | 51N                                     | NC           | -               | -                                       | NC           | -               | -                                       |
| AK8               | BK2_IO20     | -               | 52P                                     | BK2_IO8      | -               | 30P                                     | BK2_IO8      | -               | 26P                                     |
| AJ9               | BK2_IO21     | VREF2           | 52N                                     | BK2_IO9      | VREF2           | 30N                                     | BK2_IO9      | VREF2           | 26N                                     |
| AH10              | BK2_IO22     | -               | 53P                                     | BK2_IO10     | -               | 31P                                     | BK2_IO10     | -               | 27P                                     |
| -                 | -            | -               | -                                       | GND (Bank 2) | -               | -                                       | -            | -               | -                                       |
| AH11              | BK2_IO23     | -               | 53N                                     | BK2_IO11     | -               | 31N                                     | BK2_IO11     | -               | 27N                                     |
| AJ10              | BK2_IO24     | -               | 54P                                     | BK2_IO12     | -               | 32P                                     | BK2_IO12     | -               | 28P                                     |
| AK10              | BK2_IO25     | -               | 54N                                     | BK2_IO13     | -               | 32N                                     | BK2_IO13     | -               | 28N                                     |
| AH12              | BK2_IO26     | -               | 55P                                     | BK2_IO14     | -               | 33P                                     | BK2_IO14     | -               | 29P                                     |
| -                 | GND (Bank 2) | -               | -                                       | -            | -               | -                                       | -            | -               | -                                       |
| AJ11              | BK2_IO27     | -               | 55N                                     | BK2_IO15     | -               | 33N                                     | BK2_IO15     | -               | 29N                                     |
| AK11              | BK2_IO28     | -               | 56P                                     | NC           | -               | -                                       | NC           | -               | -                                       |
| AJ12              | BK2_IO29     | -               | 56N                                     | NC           | -               | -                                       | NC           | -               | -                                       |
| AG13              | BK2_IO30     | -               | 57P                                     | BK2_IO16     | -               | 34P                                     | BK2_IO16     | -               | 30P                                     |
| AH13              | BK2_IO31     | -               | 57N                                     | BK2_IO17     | -               | 34N                                     | BK2_IO17     | -               | 30N                                     |

ispXPGA Logic Signal Connections: 516-Ball fpBGA (Cont.)

| 516-Ball BGA Ball | LFX500       |                 |                                         | LFX200       |                 |                                         | LFX125       |                 |                                         |
|-------------------|--------------|-----------------|-----------------------------------------|--------------|-----------------|-----------------------------------------|--------------|-----------------|-----------------------------------------|
|                   | Signal Name  | Second Function | LVDS Pair/ sysHSI Reserved <sup>1</sup> | Signal Name  | Second Function | LVDS Pair/ sysHSI Reserved <sup>1</sup> | Signal Name  | Second Function | LVDS Pair/ sysHSI Reserved <sup>1</sup> |
| AJ13              | BK2_IO32     | -               | 58P                                     | BK2_IO18     | -               | 35P                                     | BK2_IO18     | -               | 31P                                     |
| -                 | -            | -               | -                                       | GND (Bank 2) | -               | -                                       | GND (Bank 2) | -               | -                                       |
| AK12              | BK2_IO33     | -               | 58N                                     | BK2_IO19     | -               | 35N                                     | BK2_IO19     | -               | 31N                                     |
| AK13              | BK2_IO34     | -               | 59P                                     | BK2_IO20     | -               | 36P                                     | BK2_IO20     | -               | 32P                                     |
| -                 | GND (Bank 2) | -               | -                                       | -            | -               | -                                       | -            | -               | -                                       |
| AH14              | BK2_IO35     | -               | 59N                                     | BK2_IO21     | -               | 36N                                     | BK2_IO21     | -               | 32N                                     |
| AJ14              | BK2_IO36     | -               | 60P                                     | BK2_IO22     | -               | 37P                                     | NC           | -               | -                                       |
| AK14              | BK2_IO37     | -               | 60N                                     | BK2_IO23     | -               | 37N                                     | NC           | -               | -                                       |
| AG15              | BK2_IO38     | -               | 61P                                     | BK2_IO24     | -               | 38P                                     | NC           | -               | -                                       |
| AH15              | BK2_IO39     | -               | 61N                                     | BK2_IO25     | -               | 38N                                     | NC           | -               | -                                       |
| AJ15              | BK2_IO40     | -               | 62P                                     | NC           | -               | -                                       | NC           | -               | -                                       |
| AK15              | BK2_IO41     | -               | 62N                                     | NC           | -               | -                                       | NC           | -               | -                                       |
| -                 | GND (Bank 2) | -               | -                                       | GND (Bank 2) | -               | -                                       | -            | -               | -                                       |
| -                 | GND (Bank 3) | -               | -                                       | GND (Bank 3) | -               | -                                       | -            | -               | -                                       |
| AK16              | BK3_IO0      | -               | 63P                                     | BK3_IO0      | -               | 39P                                     | BK3_IO0      | -               | 33P                                     |
| AJ16              | BK3_IO1      | -               | 63N                                     | BK3_IO1      | -               | 39N                                     | BK3_IO1      | -               | 33N                                     |
| AH16              | BK3_IO2      | -               | 64P                                     | BK3_IO2      | -               | 40P                                     | BK3_IO2      | -               | 34P                                     |
| AG16              | BK3_IO3      | -               | 64N                                     | BK3_IO3      | -               | 40N                                     | BK3_IO3      | -               | 34N                                     |
| AK17              | BK3_IO4      | -               | 65P                                     | BK3_IO4      | -               | 41P                                     | BK3_IO4      | -               | 35P                                     |
| AJ17              | BK3_IO5      | -               | 65N                                     | BK3_IO5      | -               | 41N                                     | BK3_IO5      | -               | 35N                                     |
| AH17              | BK3_IO6      | -               | 66P                                     | BK3_IO6      | -               | 42P                                     | BK3_IO6      | -               | 36P                                     |
| -                 | GND (Bank 3) | -               | -                                       | GND (Bank 3) | -               | -                                       | -            | -               | -                                       |
| AJ18              | BK3_IO7      | -               | 66N                                     | BK3_IO7      | -               | 42N                                     | BK3_IO7      | -               | 36N                                     |
| AH18              | BK3_IO8      | -               | 67P                                     | BK3_IO8      | -               | 43P                                     | BK3_IO8      | -               | 37P                                     |
| -                 | -            | -               | -                                       | -            | -               | -                                       | GND (Bank 3) | -               | -                                       |
| AG18              | BK3_IO9      | -               | 67N                                     | BK3_IO9      | -               | 43N                                     | BK3_IO9      | -               | 37N                                     |
| AK18              | BK3_IO10     | -               | 68P                                     | BK3_IO10     | -               | 44P                                     | BK3_IO10     | -               | 38P                                     |
| AK19              | BK3_IO11     | -               | 68N                                     | BK3_IO11     | -               | 44N                                     | BK3_IO11     | -               | 38N                                     |
| AJ19              | BK3_IO12     | -               | 69P                                     | BK3_IO12     | -               | 45P                                     | NC           | -               | -                                       |
| AH19              | BK3_IO13     | -               | 69N                                     | BK3_IO13     | -               | 45N                                     | NC           | -               | -                                       |
| AK20              | BK3_IO14     | -               | 70P                                     | BK3_IO14     | -               | 46P                                     | NC           | -               | -                                       |
| -                 | GND (Bank 3) | -               | -                                       | GND (Bank 3) | -               | -                                       | -            | -               | -                                       |
| AJ20              | BK3_IO15     | -               | 70N                                     | BK3_IO15     | -               | 46N                                     | NC           | -               | -                                       |
| AH20              | BK3_IO16     | -               | 71P                                     | NC           | -               | -                                       | NC           | -               | -                                       |
| AG20              | BK3_IO17     | -               | 71N                                     | NC           | -               | -                                       | NC           | -               | -                                       |
| AK21              | BK3_IO18     | -               | 72P                                     | NC           | -               | -                                       | NC           | -               | -                                       |
| AJ21              | BK3_IO19     | -               | 72N                                     | NC           | -               | -                                       | NC           | -               | -                                       |
| AH21              | BK3_IO20     | VREF3           | 73P                                     | BK3_IO16     | VREF3           | 47P                                     | BK3_IO12     | VREF3           | 39P                                     |
| AG21              | BK3_IO21     | -               | 73N                                     | BK3_IO17     | -               | 47N                                     | BK3_IO13     | -               | 39N                                     |
| AJ22              | BK3_IO22     | -               | 74P                                     | BK3_IO18     | -               | 48P                                     | BK3_IO14     | -               | 40P                                     |
| -                 | GND (Bank 3) | -               | -                                       | -            | -               | -                                       | -            | -               | -                                       |
| AH22              | BK3_IO23     | -               | 74N                                     | BK3_IO19     | -               | 48N                                     | BK3_IO15     | -               | 40N                                     |
| AK23              | BK3_IO24     | -               | 75P                                     | NC           | -               | -                                       | NC           | -               | -                                       |
| AJ23              | BK3_IO25     | -               | 75N                                     | NC           | -               | -                                       | NC           | -               | -                                       |
| AH23              | BK3_IO26     | -               | 76P                                     | NC           | -               | -                                       | NC           | -               | -                                       |
| AK24              | BK3_IO27     | -               | 76N                                     | NC           | -               | -                                       | NC           | -               | -                                       |
| AJ24              | BK3_IO28     | -               | 77P                                     | NC           | -               | -                                       | NC           | -               | -                                       |
| AG23              | BK3_IO29     | -               | 77N                                     | NC           | -               | -                                       | NC           | -               | -                                       |
| AH24              | BK3_IO30     | -               | 78P                                     | NC           | -               | -                                       | NC           | -               | -                                       |
| -                 | GND (Bank 3) | -               | -                                       | -            | -               | -                                       | -            | -               | -                                       |
| AK25              | BK3_IO31     | -               | 78N                                     | NC           | -               | -                                       | NC           | -               | -                                       |

ispXPGA Logic Signal Connections: 516-Ball fpBGA (Cont.)

| 516-Ball BGA Ball | LFX500       |                 |                                         | LFX200       |                 |                                         | LFX125       |                 |                                         |
|-------------------|--------------|-----------------|-----------------------------------------|--------------|-----------------|-----------------------------------------|--------------|-----------------|-----------------------------------------|
|                   | Signal Name  | Second Function | LVDS Pair/ sysHSI Reserved <sup>1</sup> | Signal Name  | Second Function | LVDS Pair/ sysHSI Reserved <sup>1</sup> | Signal Name  | Second Function | LVDS Pair/ sysHSI Reserved <sup>1</sup> |
| AJ25              | BK3_IO32     | -               | 79P                                     | NC           | -               | -                                       | NC           | -               | -                                       |
| AG24              | BK3_IO33     | -               | 79N                                     | NC           | -               | -                                       | NC           | -               | -                                       |
| AK26              | BK3_IO34     | -               | 80P                                     | BK3_IO20     | -               | 49P                                     | BK3_IO16     | -               | 41P                                     |
| -                 | -            | -               | -                                       | -            | -               | -                                       | GND (Bank 3) | -               | -                                       |
| AH25              | BK3_IO35     | -               | 80N                                     | BK3_IO21     | -               | 49N                                     | BK3_IO17     | -               | 41N                                     |
| AJ26              | BK3_IO36     | -               | 81P                                     | BK3_IO22     | -               | 50P                                     | BK3_IO18     | -               | 42P                                     |
| -                 | -            | -               | -                                       | GND (Bank 3) | -               | -                                       | -            | -               | -                                       |
| AH26              | BK3_IO37     | -               | 81N                                     | BK3_IO23     | -               | 50N                                     | BK3_IO19     | -               | 42N                                     |
| AK27              | BK3_IO38     | -               | 82P                                     | NC           | -               | -                                       | NC           | -               | -                                       |
| -                 | GND (Bank 3) | -               | -                                       | -            | -               | -                                       | -            | -               | -                                       |
| AJ27              | BK3_IO39     | -               | 82N                                     | NC           | -               | -                                       | NC           | -               | -                                       |
| AG26              | BK3_IO40     | -               | 83P                                     | BK3_IO24     | -               | 51P                                     | BK3_IO20     | -               | 43P                                     |
| AH27              | BK3_IO41     | -               | 83N                                     | BK3_IO25     | -               | 51N                                     | BK3_IO21     | -               | 43N                                     |
| AK28              | GSR          | -               | -                                       | GSR          | -               | -                                       | GSR          | -               | -                                       |
| AJ28              | DXP          | -               | -                                       | DXP          | -               | -                                       | DXP          | -               | -                                       |
| AK29              | DXN          | -               | -                                       | DXN          | -               | -                                       | DXN          | -               | -                                       |
| AH29              | BK4_IO0      | -               | 84P                                     | BK4_IO0      | -               | 52P/HSI2                                | BK4_IO0      | -               | 44P                                     |
| AG28              | BK4_IO1      | -               | 84N                                     | BK4_IO1      | -               | 52N/HSI2                                | BK4_IO1      | -               | 44N                                     |
| AF27              | BK4_IO2      | -               | 85P/HSI3                                | NC           | -               | -                                       | NC           | -               | -                                       |
| -                 | GND (Bank 4) | -               | -                                       | -            | -               | -                                       | -            | -               | -                                       |
| AF28              | BK4_IO3      | -               | 85N/HSI3                                | NC           | -               | -                                       | NC           | -               | -                                       |
| AJ30              | BK4_IO4      | -               | 86P/HSI3                                | NC           | -               | -                                       | NC           | -               | -                                       |
| AH30              | BK4_IO5      | -               | 86N/HSI3                                | NC           | -               | -                                       | NC           | -               | -                                       |
| AG29              | BK4_IO6      | -               | 87P/HSI3                                | NC           | -               | -                                       | NC           | -               | -                                       |
| AF29              | BK4_IO7      | -               | 87N/HSI3                                | NC           | -               | -                                       | NC           | -               | -                                       |
| AE28              | BK4_IO8      | -               | 88P/HSI3                                | NC           | -               | -                                       | NC           | -               | -                                       |
| AD27              | BK4_IO9      | -               | 88N/HSI3                                | NC           | -               | -                                       | NC           | -               | -                                       |
| AG30              | BK4_IO10     | HSI3A_SINP      | 89P/HSI3                                | BK4_IO2      | HSI2A_SINP      | 53P/HSI2                                | BK4_IO2      | -               | 45P                                     |
| -                 | GND (Bank 4) | -               | -                                       | GND (Bank 4) | -               | -                                       | -            | -               | -                                       |
| AF30              | BK4_IO11     | HSI3A_SINN      | 89N/HSI3                                | BK4_IO3      | HSI2A_SINN      | 53N/HSI2                                | BK4_IO3      | -               | 45N                                     |
| AD28              | BK4_IO12     | -               | 90P/HSI3                                | BK4_IO4      | -               | 54P/HSI2                                | BK4_IO4      | -               | 46P                                     |
| -                 | -            | -               | -                                       | -            | -               | -                                       | GND (Bank 4) | -               | -                                       |
| AC27              | BK4_IO13     | -               | 90N/HSI3                                | BK4_IO5      | -               | 54N/HSI2                                | BK4_IO5      | -               | 46N                                     |
| AE29              | BK4_IO14     | HSI3A_SOUTP     | 91P/HSI3                                | BK4_IO6      | HSI2A_SOUTP     | 55P/HSI2                                | NC           | -               | -                                       |
| AE30              | BK4_IO15     | HSI3A_SOUTN     | 91N/HSI3                                | BK4_IO7      | HSI2A_SOUTN     | 55N/HSI2                                | NC           | -               | -                                       |
| AD29              | BK4_IO16     | -               | 92P/HSI3                                | BK4_IO8      | -               | 56P/HSI2                                | BK4_IO6      | -               | 47P                                     |
| AD30              | BK4_IO17     | VREF4           | 92N/HSI3                                | BK4_IO9      | VREF4           | 56N/HSI2                                | BK4_IO7      | VREF4           | 47N                                     |
| AC28              | BK4_IO18     | HSI3B_SINP      | 93P                                     | BK4_IO10     | HSI2B_SINP      | 57P/HSI2                                | NC           | -               | -                                       |
| -                 | GND (Bank 4) | -               | -                                       | GND (Bank 4) | -               | -                                       | -            | -               | -                                       |
| AB28              | BK4_IO19     | HSI3B_SINN      | 93N                                     | BK4_IO11     | HSI2B_SINN      | 57N/HSI2                                | NC           | -               | -                                       |
| AA27              | BK4_IO20     | PLL_RST4        | 94P                                     | BK4_IO12     | PLL_RST4        | 58P/HSI2                                | BK4_IO8      | PLL_RST4        | 48P                                     |
| AB29              | BK4_IO21     | PLL_RST5        | 94N                                     | BK4_IO13     | PLL_RST5        | 58N/HSI2                                | BK4_IO9      | PLL_RST5        | 48N                                     |
| AC29              | BK4_IO22     | HSI3B_SOUTP     | 95P                                     | BK4_IO14     | HSI2B_SOUTP     | 59P/HSI2                                | BK4_IO10     | -               | 49P                                     |
| AC30              | BK4_IO23     | HSI3B_SOUTN     | 95N                                     | BK4_IO15     | HSI2B_SOUTN     | 59N/HSI2                                | BK4_IO11     | -               | 49N                                     |
| AA28              | BK4_IO24     | -               | 96P                                     | NC           | -               | -                                       | NC           | -               | -                                       |
| Y27               | BK4_IO25     | -               | 96N                                     | NC           | -               | -                                       | NC           | -               | -                                       |
| Y28               | BK4_IO26     | -               | 97P                                     | NC           | -               | -                                       | NC           | -               | -                                       |
| -                 | GND (Bank 4) | -               | -                                       | -            | -               | -                                       | -            | -               | -                                       |
| AA29              | BK4_IO27     | -               | 97N                                     | NC           | -               | -                                       | NC           | -               | -                                       |
| Y29               | BK4_IO28     | -               | 98P                                     | BK4_IO16     | -               | 60P                                     | BK4_IO12     | -               | 50P                                     |
| -                 | -            | -               | -                                       | -            | -               | -                                       | GND (Bank 4) | -               | -                                       |

ispXPGA Logic Signal Connections: 516-Ball fpBGA (Cont.)

| 516-Ball BGA Ball | LFX500       |                 |                                         | LFX200       |                 |                                         | LFX125       |                 |                                         |
|-------------------|--------------|-----------------|-----------------------------------------|--------------|-----------------|-----------------------------------------|--------------|-----------------|-----------------------------------------|
|                   | Signal Name  | Second Function | LVDS Pair/ sysHSI Reserved <sup>1</sup> | Signal Name  | Second Function | LVDS Pair/ sysHSI Reserved <sup>1</sup> | Signal Name  | Second Function | LVDS Pair/ sysHSI Reserved <sup>1</sup> |
| AA30              | BK4_IO29     | -               | 98N                                     | BK4_IO17     | -               | 60N                                     | BK4_IO13     | -               | 50N                                     |
| W28               | BK4_IO30     | SS_CLKIN1P      | 99P                                     | BK4_IO18     | SS_CLKIN1P      | 61P                                     | BK4_IO14     | SS_CLKIN1P      | 51P                                     |
| -                 | -            | -               | -                                       | GND (Bank 4) | -               | -                                       | -            | -               | -                                       |
| W29               | BK4_IO31     | SS_CLKIN1N      | 99N                                     | BK4_IO19     | SS_CLKIN1N      | 61N                                     | BK4_IO15     | SS_CLKIN1N      | 51N                                     |
| Y30               | BK4_IO32     | -               | 100P                                    | NC           | -               | -                                       | NC           | -               | -                                       |
| W30               | BK4_IO33     | -               | 100N                                    | NC           | -               | -                                       | NC           | -               | -                                       |
| V27               | BK4_IO34     | -               | 101P                                    | NC           | -               | -                                       | NC           | -               | -                                       |
| -                 | GND (Bank 4) | -               | -                                       | -            | -               | -                                       | -            | -               | -                                       |
| V28               | BK4_IO35     | -               | 101N                                    | NC           | -               | -                                       | NC           | -               | -                                       |
| V29               | BK4_IO36     | PLL_FBK4        | 102P                                    | BK4_IO20     | PLL_FBK4        | 62P                                     | BK4_IO16     | PLL_FBK4        | 52P                                     |
| V30               | BK4_IO37     | PLL_FBK5        | 102N                                    | BK4_IO21     | PLL_FBK5        | 62N                                     | BK4_IO17     | PLL_FBK5        | 52N                                     |
| U30               | BK4_IO38     | SS_CLKOUT1P     | 103P                                    | BK4_IO22     | SS_CLKOUT1P     | 63P                                     | BK4_IO18     | SS_CLKOUT1P     | 53P                                     |
| U29               | BK4_IO39     | SS_CLKOUT1N     | 103N                                    | BK4_IO23     | SS_CLKOUT1N     | 63N                                     | BK4_IO19     | SS_CLKOUT1N     | 53N                                     |
| U28               | BK4_IO40     | CLK_OUT4        | 104P                                    | BK4_IO24     | CLK_OUT4        | 64P                                     | BK4_IO20     | CLK_OUT4        | 54P                                     |
| -                 | GND (Bank 4) | -               | -                                       | -            | -               | -                                       | -            | -               | -                                       |
| T27               | BK4_IO41     | CLK_OUT5        | 104N                                    | BK4_IO25     | CLK_OUT5        | 64N                                     | BK4_IO21     | CLK_OUT5        | 54N                                     |
| -                 | -            | -               | -                                       | GND (Bank 4) | -               | -                                       | -            | -               | -                                       |
| T28               | GCLK4        | -               | LVDS Pair2P                             | GCLK4        | -               | LVDS Pair2P                             | GCLK4        | -               | LVDS Pair2P                             |
| T29               | GCLK5        | -               | LVDS Pair2N                             | GCLK5        | -               | LVDS Pair2N                             | GCLK5        | -               | LVDS Pair2N                             |
| T30               | VCCP1        | -               | -                                       | VCCP1        | -               | -                                       | VCCP1        | -               | -                                       |
| R29               | GNDP1        | -               | -                                       | GNDP1        | -               | -                                       | GNDP1        | -               | -                                       |
| R28               | GCLK6        | -               | LVDS Pair3P                             | GCLK6        | -               | LVDS Pair3P                             | GCLK6        | -               | LVDS Pair3P                             |
| R27               | GCLK7        | -               | LVDS Pair3N                             | GCLK7        | -               | LVDS Pair3N                             | GCLK7        | -               | LVDS Pair3N                             |
| -                 | -            | -               | -                                       | GND (Bank 5) | -               | -                                       | -            | -               | -                                       |
| R30               | BK5_IO0      | CLK_OUT6        | 105P                                    | BK5_IO0      | CLK_OUT6        | 65P                                     | BK5_IO0      | CLK_OUT6        | 55P                                     |
| -                 | GND (Bank 5) | -               | -                                       | -            | -               | -                                       | -            | -               | -                                       |
| P30               | BK5_IO1      | CLK_OUT7        | 105N                                    | BK5_IO1      | CLK_OUT7        | 65N                                     | BK5_IO1      | CLK_OUT7        | 55N                                     |
| P29               | BK5_IO2      | -               | 106P                                    | BK5_IO2      | -               | 66P                                     | BK5_IO2      | -               | 56P                                     |
| -                 | -            | -               | -                                       | -            | -               | -                                       | GND (Bank 5) | -               | -                                       |
| P28               | BK5_IO3      | PLL_RST7        | 106N                                    | BK5_IO3      | PLL_RST7        | 66N                                     | BK5_IO3      | PLL_RST7        | 56N                                     |
| N30               | BK5_IO4      | PLL_FBK6        | 107P                                    | BK5_IO4      | PLL_FBK6        | 67P                                     | BK5_IO4      | PLL_FBK6        | 57P/HSI1                                |
| N29               | BK5_IO5      | -               | 107N                                    | BK5_IO5      | -               | 67N                                     | BK5_IO5      | -               | 57N/HSI1                                |
| N28               | BK5_IO6      | PLL-RST6        | 108P                                    | BK5_IO6      | PLL_RST6        | 68P                                     | BK5_IO6      | PLL_RST6        | 58P//HSI1                               |
| -                 | GND (Bank 5) | -               | -                                       | GND (Bank 5) | -               | -                                       | -            | -               | -                                       |
| N27               | BK5_IO7      | PLL_FBK7        | 108N                                    | BK5_IO7      | PLL_FBK7        | 68N                                     | BK5_IO7      | PLL_FBK7        | 58N/HSI1                                |
| M30               | BK5_IO8      | -               | 109P/HSI4                               | BK5_IO8      | -               | 69P                                     | NC           | -               | -                                       |
| M29               | BK5_IO9      | -               | 109N/HSI4                               | BK5_IO9      | -               | 69N                                     | NC           | -               | -                                       |
| L30               | BK5_IO10     | HSI4A_SINP      | 110P/HSI4                               | BK5_IO10     | HSI3A_SINP      | 70P/HSI3                                | BK5_IO8      | HSI1A_SINP      | 59P/HSI1                                |
| -                 | -            | -               | -                                       | -            | -               | -                                       | GND (Bank 5) | -               | -                                       |
| L29               | BK5_IO11     | HSI4A_SINN      | 110N/HSI4                               | BK5_IO11     | HSI3A_SINN      | 70N/HSI3                                | BK5_IO9      | HSI1A_SINN      | 59N/HSI1                                |
| M28               | BK5_IO12     | -               | 111P/HSI4                               | BK5_IO12     | -               | 71P/HSI3                                | BK5_IO10     | -               | 60P/HSI1                                |
| L28               | BK5_IO13     | -               | 111N/HSI4                               | BK5_IO13     | -               | 71N/HSI3                                | BK5_IO11     | -               | 60N/HSI1                                |
| K30               | BK5_IO14     | HSI4A_SOUTP     | 112P/HSI4                               | BK5_IO14     | HSI3A_SOUTP     | 72P/HSI3                                | BK5_IO12     | HSI1A_SOUTP     | 61P/HSI1                                |
| -                 | GND (Bank 5) | -               | -                                       | GND (Bank 5) | -               | -                                       | -            | -               | -                                       |
| K29               | BK5_IO15     | HSI4A_SOUTN     | 112N/HSI4                               | BK5_IO15     | HSI3A_SOUTN     | 72N/HSI3                                | BK5_IO13     | HSI1A_SOUTN     | 61N/HSI1                                |
| L27               | BK5_IO16     | -               | 113P/HSI4                               | NC           | -               | -                                       | NC           | -               | -                                       |
| K28               | BK5_IO17     | -               | 113N/HSI4                               | NC           | -               | -                                       | NC           | -               | -                                       |
| H30               | BK5_IO18     | HSI4B_SINP      | 114P/HSI4                               | NC           | -               | -                                       | NC           | -               | -                                       |
| G30               | BK5_IO19     | HSI4B_SINN      | 114N/HSI4                               | NC           | -               | -                                       | NC           | -               | -                                       |
| J28               | BK5_IO20     | -               | 115P/HSI4                               | NC           | -               | -                                       | NC           | -               | -                                       |
| K27               | BK5_IO21     | -               | 115N/HSI4                               | NC           | -               | -                                       | NC           | -               | -                                       |



ispXPGA Logic Signal Connections: 516-Ball fpBGA (Cont.)

| 516-Ball BGA Ball | LFX500       |                 |                                         | LFX200       |                 |                                         | LFX125       |                 |                                         |
|-------------------|--------------|-----------------|-----------------------------------------|--------------|-----------------|-----------------------------------------|--------------|-----------------|-----------------------------------------|
|                   | Signal Name  | Second Function | LVDS Pair/ sysHSI Reserved <sup>1</sup> | Signal Name  | Second Function | LVDS Pair/ sysHSI Reserved <sup>1</sup> | Signal Name  | Second Function | LVDS Pair/ sysHSI Reserved <sup>1</sup> |
| J29               | BK5_IO22     | HSI4B_SOUTP     | 116P/HSI4                               | NC           | -               | -                                       | NC           | -               | -                                       |
| -                 | GND (Bank 5) | -               | -                                       | -            | -               | -                                       | -            | -               | -                                       |
| H29               | BK5_IO23     | HSI4B_SOUTN     | 116N/HSI4                               | NC           | -               | -                                       | NC           | -               | -                                       |
| F30               | BK5_IO24     | -               | 117P/HSI5                               | NC           | -               | -                                       | NC           | -               | -                                       |
| G29               | BK5_IO25     | -               | 117N/HSI5                               | NC           | -               | -                                       | NC           | -               | -                                       |
| H28               | BK5_IO26     | HSI5A_SINP      | 118P/HSI5                               | NC           | -               | -                                       | NC           | -               | -                                       |
| H27               | BK5_IO27     | HSI5A_SINN      | 118N/HSI5                               | NC           | -               | -                                       | NC           | -               | -                                       |
| E30               | BK5_IO28     | -               | 119P/HSI5                               | NC           | -               | -                                       | NC           | -               | -                                       |
| F29               | BK5_IO29     | -               | 119N/HSI5                               | NC           | -               | -                                       | NC           | -               | -                                       |
| G28               | BK5_IO30     | HSI5A_SOUTP     | 120P/HSI5                               | NC           | -               | -                                       | NC           | -               | -                                       |
| -                 | GND (Bank 5) | -               | -                                       | -            | -               | -                                       | -            | -               | -                                       |
| G27               | BK5_IO31     | HSI5A_SOUTN     | 120N/HSI5                               | NC           | -               | -                                       | NC           | -               | -                                       |
| E29               | BK5_IO32     | VREF5           | 121P/HSI5                               | BK5_IO16     | VREF5           | 73P/HSI3                                | BK5_IO14     | VREF5           | 62P/HSI1                                |
| F28               | BK5_IO33     | -               | 121N/HSI5                               | BK5_IO17     | -               | 73N/HSI3                                | BK5_IO15     | -               | 62N/HSI1                                |
| D30               | BK5_IO34     | HSI5B_SINP      | 122P/HSI5                               | BK5_IO18     | HSI3B_SINP      | 74P/HSI3                                | BK5_IO16     | HSI1B_SINP      | 63P/HSI1                                |
| -                 | -            | -               | -                                       | -            | -               | -                                       | GND (Bank 5) | -               | -                                       |
| C30               | BK5_IO35     | HSI5B_SINN      | 122N/HSI5                               | BK5_IO19     | HSI3B_SINN      | 74N/HSI3                                | BK5_IO17     | HSI1B_SINN      | 63N/HSI1                                |
| D29               | BK5_IO36     | -               | 123P/HSI5                               | BK5_IO20     | -               | 75P/HSI3                                | NC           | -               | -                                       |
| D28               | BK5_IO37     | -               | 123N/HSI5                               | BK5_IO21     | -               | 75N/HSI3                                | NC           | -               | -                                       |
| E28               | BK5_IO38     | HSI5B_SOUTP     | 124P/HSI5                               | BK5_IO22     | HSI3B_SOUTP     | 76P/HSI3                                | BK5_IO20     | HSI1B_SOUTP     | 65P/HSI1                                |
| -                 | GND (Bank 5) | -               | -                                       | GND (Bank 5) | -               | -                                       | -            | -               | -                                       |
| E27               | BK5_IO39     | HSI5B_SOUTN     | 124N/HSI5                               | BK5_IO23     | HSI3B_SOUTN     | 76N/HSI3                                | BK5_IO21     | HSI1B_SOUTN     | 65N/HSI1                                |
| C29               | BK5_IO40     | -               | 125P                                    | BK5_IO24     | -               | 77P/HSI3                                | BK5_IO18     | -               | 64P/HSI1                                |
| B30               | BK5_IO41     | -               | 125N                                    | BK5_IO25     | -               | 77N/HSI3                                | BK5_IO19     | -               | 64N/HSI1                                |
| A29               | CFG0         | -               | -                                       | CFG0         | -               | -                                       | CFG0         | -               | -                                       |
| B28               | DONE         | -               | -                                       | DONE         | -               | -                                       | DONE         | -               | -                                       |
| A28               | PROGRAMb     | -               | -                                       | PROGRAMb     | -               | -                                       | PROGRAMb     | -               | -                                       |
| D26               | BK6_IO0      | INITb           | 126P                                    | BK6_IO0      | INITb           | 78P                                     | BK6_IO0      | INITb           | 66P                                     |
| C27               | BK6_IO1      | CCLK            | 126N                                    | BK6_IO1      | CCLK            | 78N                                     | BK6_IO1      | CCLK            | 66N                                     |
| B27               | BK6_IO2      | -               | 127P                                    | BK6_IO2      | -               | 79P                                     | BK6_IO2      | -               | 67P                                     |
| -                 | GND (Bank 6) | -               | -                                       | GND (Bank 6) | -               | -                                       | -            | -               | -                                       |
| A27               | BK6_IO3      | -               | 127N                                    | BK6_IO3      | -               | 79N                                     | BK6_IO3      | -               | 67N                                     |
| C26               | BK6_IO4      | CSb             | 128P                                    | BK6_IO4      | CSb             | 80P                                     | BK6_IO4      | CSb             | 68P                                     |
| -                 | -            | -               | -                                       | -            | -               | -                                       | GND (Bank 6) | -               | -                                       |
| B26               | BK6_IO5      | Read            | 128N                                    | BK6_IO5      | Read            | 80N                                     | BK6_IO5      | Read            | 68N                                     |
| A26               | BK6_IO6      | -               | 129P                                    | NC           | -               | -                                       | NC           | -               | -                                       |
| C25               | BK6_IO7      | -               | 129N                                    | NC           | -               | -                                       | NC           | -               | -                                       |
| D24               | BK6_IO8      | -               | 130P                                    | NC           | -               | -                                       | NC           | -               | -                                       |
| B25               | BK6_IO9      | -               | 130N                                    | NC           | -               | -                                       | NC           | -               | -                                       |
| A25               | BK6_IO10     | -               | 131P                                    | NC           | -               | -                                       | NC           | -               | -                                       |
| -                 | GND (Bank 6) | -               | -                                       | -            | -               | -                                       | -            | -               | -                                       |
| C24               | BK6_IO11     | -               | 131N                                    | NC           | -               | -                                       | NC           | -               | -                                       |
| D23               | BK6_IO12     | -               | 132P                                    | NC           | -               | -                                       | NC           | -               | -                                       |
| B24               | BK6_IO13     | -               | 132N                                    | NC           | -               | -                                       | NC           | -               | -                                       |
| C23               | BK6_IO14     | -               | 133P                                    | NC           | -               | -                                       | NC           | -               | -                                       |
| A24               | BK6_IO15     | -               | 133N                                    | NC           | -               | -                                       | NC           | -               | -                                       |
| C22               | BK6_IO16     | -               | 134P                                    | NC           | -               | -                                       | NC           | -               | -                                       |
| B23               | BK6_IO17     | -               | 134N                                    | NC           | -               | -                                       | NC           | -               | -                                       |
| B22               | BK6_IO18     | DATA7           | 135P                                    | BK6_IO6      | DATA7           | 81P                                     | BK6_IO6      | DATA7           | 69P                                     |
| -                 | GND (Bank 6) | -               | -                                       | -            | -               | -                                       | -            | -               | -                                       |
| A23               | BK6_IO19     | DATA6           | 135N                                    | BK6_IO7      | DATA6           | 81N                                     | BK6_IO7      | DATA6           | 69N                                     |

ispXPGA Logic Signal Connections: 516-Ball fpBGA (Cont.)

| 516-Ball BGA Ball | LFX500       |                 |                                         | LFX200       |                 |                                         | LFX125       |                 |                                         |
|-------------------|--------------|-----------------|-----------------------------------------|--------------|-----------------|-----------------------------------------|--------------|-----------------|-----------------------------------------|
|                   | Signal Name  | Second Function | LVDS Pair/ sysHSI Reserved <sup>1</sup> | Signal Name  | Second Function | LVDS Pair/ sysHSI Reserved <sup>1</sup> | Signal Name  | Second Function | LVDS Pair/ sysHSI Reserved <sup>1</sup> |
| D21               | BK6_IO20     | -               | 136P                                    | BK6_IO8      | -               | 82P                                     | BK6_IO8      | -               | 70P                                     |
| C21               | BK6_IO21     | VREF6           | 136N                                    | BK6_IO9      | VREF6           | 82N                                     | BK6_IO9      | VREF6           | 70N                                     |
| B21               | BK6_IO22     | DATA5           | 137P                                    | BK6_IO10     | DATA5           | 83P                                     | BK6_IO10     | DATA5           | 71P                                     |
| -                 | -            | -               | -                                       | GND (Bank 6) | -               | -                                       | -            | -               | -                                       |
| A21               | BK6_IO23     | DATA4           | 137N                                    | BK6_IO11     | DATA4           | 83N                                     | BK6_IO11     | DATA4           | 71N                                     |
| D20               | BK6_IO24     | -               | 138P                                    | BK6_IO12     | -               | 84P                                     | BK6_IO12     | -               | 72P                                     |
| -                 | -            | -               | -                                       | -            | -               | -                                       | GND (Bank 6) | -               | -                                       |
| C20               | BK6_IO25     | -               | 138N                                    | BK6_IO13     | -               | 84N                                     | BK6_IO13     | -               | 72N                                     |
| B20               | BK6_IO26     | DATA3           | 139P                                    | BK6_IO14     | DATA3           | 85P                                     | BK6_IO14     | DATA3           | 73P                                     |
| -                 | GND (Bank 6) | -               | -                                       | -            | -               | -                                       | -            | -               | -                                       |
| A20               | BK6_IO27     | DATA2           | 139N                                    | BK6_IO15     | DATA2           | 85N                                     | BK6_IO15     | DATA2           | 73N                                     |
| C19               | BK6_IO28     | -               | 140P                                    | BK6_IO16     | -               | 86P                                     | BK6_IO16     | -               | 74P                                     |
| B19               | BK6_IO29     | -               | 140N                                    | BK6_IO17     | -               | 86N                                     | BK6_IO17     | -               | 74N                                     |
| A19               | BK6_IO30     | DATA1           | 141P                                    | BK6_IO18     | DATA1           | 87P                                     | BK6_IO18     | DATA1           | 75P                                     |
| -                 | -            | -               | -                                       | GND (Bank 6) | -               | -                                       | GND (Bank 6) | -               | -                                       |
| A18               | BK6_IO31     | DATA0           | 141N                                    | BK6_IO19     | DATA0           | 87N                                     | BK6_IO19     | DATA0           | 75N                                     |
| D18               | BK6_IO32     | -               | 142P                                    | BK6_IO20     | -               | 88P                                     | BK6_IO20     | -               | 76P                                     |
| C18               | BK6_IO33     | -               | 142N                                    | BK6_IO21     | -               | 88N                                     | BK6_IO21     | -               | 76N                                     |
| B18               | BK6_IO34     | -               | 143P                                    | BK6_IO22     | -               | 89P                                     | NC           | -               | -                                       |
| -                 | GND (Bank 6) | -               | -                                       | -            | -               | -                                       | -            | -               | -                                       |
| C17               | BK6_IO35     | -               | 143N                                    | BK6_IO23     | -               | 89N                                     | NC           | -               | -                                       |
| B17               | BK6_IO36     | -               | 144P                                    | NC           | -               | -                                       | NC           | -               | -                                       |
| A17               | BK6_IO37     | -               | 144N                                    | NC           | -               | -                                       | NC           | -               | -                                       |
| D16               | BK6_IO38     | -               | 145P                                    | NC           | -               | -                                       | NC           | -               | -                                       |
| C16               | BK6_IO39     | -               | 145N                                    | NC           | -               | -                                       | NC           | -               | -                                       |
| B16               | BK6_IO40     | -               | 146P                                    | BK6_IO24     | -               | 90P                                     | NC           | -               | -                                       |
| A16               | BK6_IO41     | -               | 146N                                    | BK6_IO25     | -               | 90N                                     | NC           | -               | -                                       |
| -                 | GND (Bank 6) | -               | -                                       | GND (Bank 6) | -               | -                                       | -            | -               | -                                       |
| -                 | GND (Bank 7) | -               | -                                       | GND (Bank 7) | -               | -                                       | -            | -               | -                                       |
| A15               | BK7_IO0      | -               | 147P                                    | BK7_IO0      | -               | 91P                                     | BK7_IO0      | -               | 77P                                     |
| B15               | BK7_IO1      | -               | 147N                                    | BK7_IO1      | -               | 91N                                     | BK7_IO1      | -               | 77N                                     |
| C15               | BK7_IO2      | -               | 148P                                    | BK7_IO2      | -               | 92P                                     | BK7_IO2      | -               | 78P                                     |
| -                 | -            | -               | -                                       | -            | -               | -                                       | GND (Bank 7) | -               | -                                       |
| D15               | BK7_IO3      | -               | 148N                                    | BK7_IO3      | -               | 92N                                     | BK7_IO3      | -               | 78N                                     |
| A14               | BK7_IO4      | -               | 149P                                    | BK7_IO4      | -               | 93P                                     | BK7_IO4      | -               | 79P                                     |
| B14               | BK7_IO5      | -               | 149N                                    | BK7_IO5      | -               | 93N                                     | BK7_IO5      | -               | 79N                                     |
| C14               | BK7_IO6      | -               | 150P                                    | BK7_IO6      | -               | 94P                                     | NC           | -               | -                                       |
| -                 | GND (Bank 7) | -               | -                                       | GND (Bank 7) | -               | -                                       | -            | -               | -                                       |
| A13               | BK7_IO7      | -               | 150N                                    | BK7_IO7      | -               | 94N                                     | NC           | -               | -                                       |
| B13               | BK7_IO8      | -               | 151P                                    | BK7_IO8      | -               | 95P                                     | NC           | -               | -                                       |
| C13               | BK7_IO9      | -               | 151N                                    | BK7_IO9      | -               | 95N                                     | NC           | -               | -                                       |
| D13               | BK7_IO10     | -               | 152P                                    | BK7_IO10     | -               | 96P                                     | BK7_IO6      | -               | 80P                                     |
| B12               | BK7_IO11     | -               | 152N                                    | BK7_IO11     | -               | 96N                                     | BK7_IO7      | -               | 80N                                     |
| C12               | BK7_IO12     | -               | 153P                                    | BK7_IO12     | -               | 97P                                     | BK7_IO8      | -               | 81P                                     |
| -                 | -            | -               | -                                       | -            | -               | -                                       | GND (Bank 7) | -               | -                                       |
| A12               | BK7_IO13     | -               | 153N                                    | BK7_IO13     | -               | 97N                                     | BK7_IO9      | -               | 81N                                     |
| A11               | BK7_IO14     | -               | 154P                                    | BK7_IO14     | -               | 98P                                     | BK7_IO10     | -               | 82P                                     |
| -                 | GND (Bank 7) | -               | -                                       | GND (Bank 7) | -               | -                                       | -            | -               | -                                       |
| B11               | BK7_IO15     | -               | 154N                                    | BK7_IO15     | -               | 98N                                     | BK7_IO11     | -               | 82N                                     |
| C11               | BK7_IO16     | -               | 155P                                    | NC           | -               | -                                       | NC           | -               | -                                       |
| D11               | BK7_IO17     | -               | 155N                                    | NC           | -               | -                                       | NC           | -               | -                                       |

ispXPGA Logic Signal Connections: 516-Ball fpBGA (Cont.)

| 516-Ball BGA Ball | LFX500       |                 |                                         | LFX200       |                 |                                         | LFX125       |                 |                                         |
|-------------------|--------------|-----------------|-----------------------------------------|--------------|-----------------|-----------------------------------------|--------------|-----------------|-----------------------------------------|
|                   | Signal Name  | Second Function | LVDS Pair/ sysHSI Reserved <sup>1</sup> | Signal Name  | Second Function | LVDS Pair/ sysHSI Reserved <sup>1</sup> | Signal Name  | Second Function | LVDS Pair/ sysHSI Reserved <sup>1</sup> |
| A10               | BK7_IO18     | -               | 156P                                    | NC           | -               | -                                       | NC           | -               | -                                       |
| B10               | BK7_IO19     | -               | 156N                                    | NC           | -               | -                                       | NC           | -               | -                                       |
| C10               | BK7_IO20     | VREF7           | 157P                                    | BK7_IO16     | VREF7           | 99P                                     | BK7_IO12     | VREF7           | 83P                                     |
| D10               | BK7_IO21     | -               | 157N                                    | BK7_IO17     | -               | 99N                                     | BK7_IO13     | -               | 83N                                     |
| B9                | BK7_IO22     | -               | 158P                                    | BK7_IO18     | -               | 100P                                    | BK7_IO14     | -               | 84P                                     |
| -                 | GND (Bank 7) | -               | -                                       | -            | -               | -                                       | -            | -               | -                                       |
| C9                | BK7_IO23     | -               | 158N                                    | BK7_IO19     | -               | 100N                                    | BK7_IO15     | -               | 84N                                     |
| A8                | BK7_IO24     | -               | 159P                                    | BK7_IO20     | -               | 101P                                    | BK7_IO16     | -               | 85P                                     |
| -                 | -            | -               | -                                       | -            | -               | -                                       | GND (Bank 7) | -               | -                                       |
| B8                | BK7_IO25     | -               | 159N                                    | BK7_IO21     | -               | 101N                                    | BK7_IO17     | -               | 85N                                     |
| C8                | BK7_IO26     | -               | 160P                                    | NC           | -               | -                                       | NC           | -               | -                                       |
| D8                | BK7_IO27     | -               | 160N                                    | NC           | -               | -                                       | NC           | -               | -                                       |
| A7                | BK7_IO28     | -               | 161P                                    | NC           | -               | -                                       | NC           | -               | -                                       |
| B7                | BK7_IO29     | -               | 161N                                    | NC           | -               | -                                       | NC           | -               | -                                       |
| C7                | BK7_IO30     | -               | 162P                                    | NC           | -               | -                                       | NC           | -               | -                                       |
| -                 | GND (Bank 7) | -               | -                                       | -            | -               | -                                       | -            | -               | -                                       |
| D7                | BK7_IO31     | -               | 162N                                    | NC           | -               | -                                       | NC           | -               | -                                       |
| A6                | BK7_IO32     | -               | 163P                                    | NC           | -               | -                                       | NC           | -               | -                                       |
| B6                | BK7_IO33     | -               | 163N                                    | NC           | -               | -                                       | NC           | -               | -                                       |
| B5                | BK7_IO34     | -               | 164P                                    | NC           | -               | -                                       | NC           | -               | -                                       |
| C6                | BK7_IO35     | -               | 164N                                    | NC           | -               | -                                       | NC           | -               | -                                       |
| A5                | BK7_IO36     | -               | 165P                                    | NC           | -               | -                                       | NC           | -               | -                                       |
| A4                | BK7_IO37     | -               | 165N                                    | NC           | -               | -                                       | NC           | -               | -                                       |
| B4                | BK7_IO38     | -               | 166P                                    | BK7_IO22     | -               | 102P                                    | BK7_IO18     | -               | 86P                                     |
| -                 | GND (Bank 7) | -               | -                                       | GND (Bank 7) | -               | -                                       | -            | -               | -                                       |
| C5                | BK7_IO39     | -               | 166N                                    | BK7_IO23     | -               | 102N                                    | BK7_IO19     | -               | 86N                                     |
| A3                | BK7_IO40     | -               | 167P                                    | BK7_IO24     | -               | 103P                                    | BK7_IO20     | -               | 87P                                     |
| A2                | BK7_IO41     | -               | 167N                                    | BK7_IO25     | -               | 103N                                    | BK7_IO21     | -               | 87N                                     |
| D5                | TDO          | -               | -                                       | TDO          | -               | -                                       | TDO          | -               | -                                       |
| C4                | VCCJ         | -               | -                                       | VCCJ         | -               | -                                       | VCCJ         | -               | -                                       |
| B3                | TDI          | -               | -                                       | TDI          | -               | -                                       | TDI          | -               | -                                       |

1. If a sysHSI Block is used, the indicated sysHSI reserved pins are unavailable for general purpose I/O use.

ispXPGA Logic Signal Connections: 680-Ball fpBGA

| LFX1200        |              |                 |                                        |
|----------------|--------------|-----------------|----------------------------------------|
| 680-Ball fpBGA | Signal Name  | Second Function | LVDS Pair/sysHSI Reserved <sup>1</sup> |
| C4             | BK0_IO0      | -               | 0P                                     |
| B4             | BK0_IO1      | -               | 0N                                     |
| E6             | BK0_IO2      | -               | 1P                                     |
| -              | GND (Bank 0) | -               | -                                      |
| D6             | BK0_IO3      | -               | 1N                                     |
| A4             | BK0_IO4      | -               | 2P                                     |
| E8             | BK0_IO5      | -               | 2N                                     |
| C5             | BK0_IO6      | HSI0A_SOUTP     | 3P                                     |
| C6             | BK0_IO7      | HSI0A_SOUTN     | 3N                                     |
| A6             | BK0_IO8      | -               | 4P                                     |
| A5             | BK0_IO9      | -               | 4N                                     |
| B6             | BK0_IO10     | HSI0A_SINP      | 5P/HSI0                                |
| -              | GND (Bank 0) | -               | -                                      |
| B5             | BK0_IO11     | HSI0A_SINN      | 5N/HSI0                                |
| B7             | BK0_IO12     | VREF0           | 6P/HSI0                                |
| A7             | BK0_IO13     | -               | 6N/HSI0                                |
| D8             | BK0_IO14     | HSI0B_SOUTP     | 7P/HSI0                                |
| D7             | BK0_IO15     | HSI0B_SOUTN     | 7N/HSI0                                |
| D9             | BK0_IO16     | -               | 8P/HSI0                                |
| E10            | BK0_IO17     | -               | 8N/HSI0                                |
| C8             | BK0_IO18     | HSI0B_SINP      | 9P/HSI0                                |
| -              | GND (Bank 0) | -               | -                                      |
| C7             | BK0_IO19     | HSI0B_SINN      | 9N/HSI0                                |
| A8             | BK0_IO20     | -               | 10P/HSI0                               |
| A9             | BK0_IO21     | -               | 10N/HSI0                               |
| C9             | BK0_IO22     | HSI1A_SOUTP     | 11P/HSI0                               |
| B8             | BK0_IO23     | HSI1A_SOUTN     | 11N/HSI0                               |
| B9             | BK0_IO24     | -               | 12P/HSI0                               |
| B10            | BK0_IO25     | -               | 12N/HSI0                               |
| D11            | BK0_IO26     | HSI1A_SINP      | 13P/HSI1                               |
| -              | GND (Bank 0) | -               | -                                      |
| D10            | BK0_IO27     | HSI1A_SINN      | 13N/HSI1                               |
| A10            | BK0_IO28     | -               | 14P/HSI1                               |
| C12            | BK0_IO29     | -               | 14N/HSI1                               |
| D12            | BK0_IO30     | HSI1B_SOUTP     | 15P/HSI1                               |
| C11            | BK0_IO31     | HSI1B_SOUTN     | 15N/HSI1                               |
| A12            | BK0_IO32     | -               | 16P/HSI1                               |
| A13            | BK0_IO33     | -               | 16N/HSI1                               |
| B13            | BK0_IO34     | HSI1B_SINP      | 17P/HSI1                               |
| -              | GND (Bank 0) | -               | -                                      |
| B12            | BK0_IO35     | HSI1B_SINN      | 17N/HSI1                               |
| E14            | BK0_IO36     | -               | 18P/HSI1                               |

**ispXPGA Logic Signal Connections: 680-Ball fpBGA (Cont.)**

| LFX1200        |              |                 |                                        |
|----------------|--------------|-----------------|----------------------------------------|
| 680-Ball fpBGA | Signal Name  | Second Function | LVDS Pair/sysHSI Reserved <sup>1</sup> |
| D14            | BK0_IO37     | -               | 18N/HSI1                               |
| C13            | BK0_IO38     | HSI2A_SOUTP     | 19P/HSI1                               |
| D13            | BK0_IO39     | HSI2A_SOUTN     | 19N/HSI1                               |
| B14            | BK0_IO40     | -               | 20P/HSI1                               |
| A14            | BK0_IO41     | -               | 20N/HSI1                               |
| C15            | BK0_IO42     | HSI2A_SINP      | 21P/HSI2                               |
| -              | GND (Bank 0) | -               | -                                      |
| D15            | BK0_IO43     | HSI2A_SINN      | 21N/HSI2                               |
| A15            | BK0_IO44     | -               | 22P/HSI2                               |
| C16            | BK0_IO45     | -               | 22N/HSI2                               |
| B15            | BK0_IO46     | HSI2B_SOUTP     | 23P/HSI2                               |
| B16            | BK0_IO47     | HSI2B_SOUTN     | 23N/HSI2                               |
| A16            | BK0_IO48     | -               | 24P/HSI2                               |
| B17            | BK0_IO49     | -               | 24N/HSI2                               |
| D16            | BK0_IO50     | HSI2B_SINP      | 25P/HSI2                               |
| -              | GND (Bank 0) | -               | -                                      |
| E16            | BK0_IO51     | HSI2B_SINN      | 25N/HSI2                               |
| D17            | BK0_IO52     | -               | 26P/HSI2                               |
| C17            | BK0_IO53     | -               | 26N/HSI2                               |
| A18            | BK0_IO54     | PLL_RST0        | 27P/HSI2                               |
| D18            | BK0_IO55     | PLL_RST1        | 27N/HSI2                               |
| A17            | BK0_IO56     | -               | 28P/HSI2                               |
| E19            | BK0_IO57     | -               | 28N/HSI2                               |
| A19            | BK0_IO58     | PLL_FBK0        | 29P                                    |
| -              | GND (Bank 0) | -               | -                                      |
| B19            | BK0_IO59     | PLL_FBK1        | 29N                                    |
| C18            | BK0_IO60     | CLK_OUT0        | 30P                                    |
| B18            | BK0_IO61     | CLK_OUT1        | 30N                                    |
| -              | GND (Bank 0) | -               | -                                      |
| D19            | GCLK0        | -               | LVDS Pair0P                            |
| C19            | GCLK1        | -               | LVDS Pair0N                            |
| E20            | VCCP0        | -               | -                                      |
| A21            | GNDP0        | -               | -                                      |
| B21            | GCLK2        | -               | LVDS Pair1P                            |
| C21            | GCLK3        | -               | LVDS Pair1N                            |
| B23            | BK1_IO0      | CLK_OUT2        | 31P                                    |
| C23            | BK1_IO1      | CLK_OUT3        | 31N                                    |
| B22            | BK1_IO2      | SS_CLKOUT0P     | 32P                                    |
| -              | GND (Bank 1) | -               | -                                      |
| C22            | BK1_IO3      | SS_CLKOUT0N     | 32N                                    |
| D21            | BK1_IO4      | PLL_FBK2        | 33P                                    |
| E21            | BK1_IO5      | PLL_FBK3        | 33N                                    |
| B24            | BK1_IO6      | SS_CLKIN0P      | 34P                                    |

**ispXPGA Logic Signal Connections: 680-Ball fpBGA (Cont.)**

| LFX1200        |              |                 |                                        |
|----------------|--------------|-----------------|----------------------------------------|
| 680-Ball fpBGA | Signal Name  | Second Function | LVDS Pair/sysHSI Reserved <sup>1</sup> |
| C24            | BK1_IO7      | SS_CLKIN0N      | 34N                                    |
| A22            | BK1_IO8      | -               | 35P                                    |
| D22            | BK1_IO9      | -               | 35N                                    |
| A23            | BK1_IO10     | -               | 36P                                    |
| -              | GND (Bank 1) | -               | -                                      |
| B25            | BK1_IO11     | -               | 36N                                    |
| D23            | BK1_IO12     | PLL_RST2        | 37P                                    |
| A24            | BK1_IO13     | PLL_RST3        | 37N                                    |
| A25            | BK1_IO14     | -               | 38P                                    |
| E24            | BK1_IO15     | -               | 38N                                    |
| D24            | BK1_IO16     | -               | 39P                                    |
| A26            | BK1_IO17     | -               | 39N                                    |
| D25            | BK1_IO18     | -               | 40P                                    |
| -              | GND (Bank 1) | -               | -                                      |
| C25            | BK1_IO19     | -               | 40N                                    |
| B26            | BK1_IO20     | -               | 41P/HSI3                               |
| B27            | BK1_IO21     | -               | 41N/HSI3                               |
| D26            | BK1_IO22     | -               | 42P/HSI3                               |
| A27            | BK1_IO23     | -               | 42N/HSI3                               |
| A28            | BK1_IO24     | -               | 43P/HSI3                               |
| E26            | BK1_IO25     | -               | 43N/HSI3                               |
| C27            | BK1_IO26     | HSI3A_SOUTP     | 44P/HSI3                               |
| -              | GND (Bank 1) | -               | -                                      |
| D27            | BK1_IO27     | HSI3A_SOUTN     | 44N/HSI3                               |
| B28            | BK1_IO28     | -               | 45P/HSI3                               |
| A30            | BK1_IO29     | -               | 45N/HSI3                               |
| C28            | BK1_IO30     | HSI3A_SINP      | 46P/HSI3                               |
| D28            | BK1_IO31     | HSI3A_SINN      | 46N/HSI3                               |
| A31            | BK1_IO32     | -               | 47P/HSI3                               |
| B30            | BK1_IO33     | -               | 47N/HSI3                               |
| E28            | BK1_IO34     | HSI3B_SOUTP     | 48P/HSI3                               |
| -              | GND (Bank 1) | -               | -                                      |
| D29            | BK1_IO35     | HSI3B_SOUTN     | 48N/HSI3                               |
| C29            | BK1_IO36     | -               | 49P/HSI4                               |
| B31            | BK1_IO37     | -               | 49N/HSI4                               |
| D30            | BK1_IO38     | HSI3B_SINP      | 50P/HSI4                               |
| E30            | BK1_IO39     | HSI3B_SINN      | 50N/HSI4                               |
| A32            | BK1_IO40     | -               | 51P/HSI4                               |
| C31            | BK1_IO41     | -               | 51N/HSI4                               |
| D31            | BK1_IO42     | HSI4A_SOUTP     | 52P/HSI4                               |
| -              | GND (Bank 1) | -               | -                                      |
| C32            | BK1_IO43     | HSI4A_SOUTN     | 52N/HSI4                               |
| B32            | BK1_IO44     | -               | 53P/HSI4                               |

**ispXPGA Logic Signal Connections: 680-Ball fpBGA (Cont.)**

| LFX1200        |              |                 |                                        |
|----------------|--------------|-----------------|----------------------------------------|
| 680-Ball fpBGA | Signal Name  | Second Function | LVDS Pair/sysHSI Reserved <sup>1</sup> |
| A33            | BK1_IO45     | -               | 53N/HSI4                               |
| C33            | BK1_IO46     | HSI4A_SINP      | 54P/HSI4                               |
| B33            | BK1_IO47     | HSI4A_SINN      | 54N/HSI4                               |
| A34            | BK1_IO48     | -               | 55P/HSI4                               |
| A35            | BK1_IO49     | VREF1           | 55N/HSI4                               |
| D32            | BK1_IO50     | HSI4B_SOUTP     | 56P/HSI4                               |
| -              | GND (Bank 1) | -               | -                                      |
| D33            | BK1_IO51     | HSI4B_SOUTN     | 56N/HSI4                               |
| E32            | BK1_IO52     | -               | 57P                                    |
| C34            | BK1_IO53     | -               | 57N                                    |
| B34            | BK1_IO54     | HSI4B_SINP      | 58P                                    |
| B35            | BK1_IO55     | HSI4B_SINN      | 58N                                    |
| A36            | BK1_IO56     | -               | 59P                                    |
| D34            | BK1_IO57     | -               | 59N                                    |
| C35            | BK1_IO58     | -               | 60P                                    |
| -              | GND (Bank 1) | -               | -                                      |
| E34            | BK1_IO59     | -               | 60N                                    |
| B36            | BK1_IO60     | -               | 61P                                    |
| C36            | BK1_IO61     | -               | 61N                                    |
| D39            | TCK          | -               | -                                      |
| D37            | TMS          | -               | -                                      |
| D38            | TOE          | -               | -                                      |
| E37            | BK2_IO0      | -               | 62P                                    |
| F35            | BK2_IO1      | -               | 62N                                    |
| E39            | BK2_IO2      | -               | 63P                                    |
| -              | GND (Bank 2) | -               | -                                      |
| F39            | BK2_IO3      | -               | 63N                                    |
| F36            | BK2_IO4      | -               | 64P                                    |
| E38            | BK2_IO5      | -               | 64N                                    |
| G38            | BK2_IO6      | -               | 65P                                    |
| F37            | BK2_IO7      | -               | 65N                                    |
| G36            | BK2_IO8      | -               | 66P                                    |
| G39            | BK2_IO9      | -               | 66N                                    |
| H35            | BK2_IO10     | -               | 67P                                    |
| -              | GND (Bank 2) | -               | -                                      |
| F38            | BK2_IO11     | -               | 67N                                    |
| J37            | BK2_IO12     | VREF2           | 68P                                    |
| H36            | BK2_IO13     | -               | 68N                                    |
| G37            | BK2_IO14     | -               | 69P                                    |
| H37            | BK2_IO15     | -               | 69N                                    |
| H39            | BK2_IO16     | -               | 70P                                    |
| K35            | BK2_IO17     | -               | 70N                                    |
| J36            | BK2_IO18     | -               | 71P                                    |

**ispXPGA Logic Signal Connections: 680-Ball fpBGA (Cont.)**

| LFX1200        |              |                 |                                        |
|----------------|--------------|-----------------|----------------------------------------|
| 680-Ball fpBGA | Signal Name  | Second Function | LVDS Pair/sysHSI Reserved <sup>1</sup> |
| -              | GND (Bank 2) | -               | -                                      |
| K36            | BK2_IO19     | -               | 71N                                    |
| H38            | BK2_IO20     | -               | 72P                                    |
| J38            | BK2_IO21     | -               | 72N                                    |
| J39            | BK2_IO22     | -               | 73P                                    |
| L36            | BK2_IO23     | -               | 73N                                    |
| K38            | BK2_IO24     | -               | 74P                                    |
| M36            | BK2_IO25     | -               | 74N                                    |
| L37            | BK2_IO26     | -               | 75P                                    |
| -              | GND (Bank 2) | -               | -                                      |
| K39            | BK2_IO27     | -               | 75N                                    |
| L38            | BK2_IO28     | -               | 76P                                    |
| P35            | BK2_IO29     | -               | 76N                                    |
| N36            | BK2_IO30     | -               | 77P                                    |
| M37            | BK2_IO31     | -               | 77N                                    |
| L39            | BK2_IO32     | -               | 78P                                    |
| M38            | BK2_IO33     | -               | 78N                                    |
| M39            | BK2_IO34     | -               | 79P                                    |
| -              | GND (Bank 2) | -               | -                                      |
| P36            | BK2_IO35     | -               | 79N                                    |
| R36            | BK2_IO36     | -               | 80P                                    |
| N37            | BK2_IO37     | -               | 80N                                    |
| P38            | BK2_IO38     | -               | 81P                                    |
| T35            | BK2_IO39     | -               | 81N                                    |
| R37            | BK2_IO40     | -               | 82P                                    |
| R38            | BK2_IO41     | -               | 82N                                    |
| P39            | BK2_IO42     | -               | 83P                                    |
| -              | GND (Bank 2) | -               | -                                      |
| R39            | BK2_IO43     | -               | 83N                                    |
| T38            | BK2_IO44     | -               | 84P                                    |
| T36            | BK2_IO45     | -               | 84N                                    |
| T37            | BK2_IO46     | -               | 85P                                    |
| U36            | BK2_IO47     | -               | 85N                                    |
| U37            | BK2_IO48     | -               | 86P                                    |
| T39            | BK2_IO49     | -               | 86N                                    |
| V36            | BK2_IO50     | -               | 87P                                    |
| -              | GND (Bank 2) | -               | -                                      |
| U38            | BK2_IO51     | -               | 87N                                    |
| U39            | BK2_IO52     | -               | 88P                                    |
| V38            | BK2_IO53     | -               | 88N                                    |
| V37            | BK2_IO54     | -               | 89P                                    |
| W36            | BK2_IO55     | -               | 89N                                    |
| W35            | BK2_IO56     | -               | 90P                                    |



**ispXPGA Logic Signal Connections: 680-Ball fpBGA (Cont.)**

| LFX1200        |              |                 |                                        |
|----------------|--------------|-----------------|----------------------------------------|
| 680-Ball fpBGA | Signal Name  | Second Function | LVDS Pair/sysHSI Reserved <sup>1</sup> |
| V39            | BK2_IO57     | -               | 90N                                    |
| W37            | BK2_IO58     | -               | 91P                                    |
| -              | GND (Bank 2) | -               | -                                      |
| W38            | BK2_IO59     | -               | 91N                                    |
| W39            | BK2_IO60     | -               | 92P                                    |
| AA39           | BK2_IO61     | -               | 92N                                    |
| -              | GND (Bank 2) | -               | -                                      |
| -              | GND (Bank 3) | -               | -                                      |
| AA38           | BK3_IO0      | -               | 93P                                    |
| Y35            | BK3_IO1      | -               | 93N                                    |
| AA37           | BK3_IO2      | -               | 94P                                    |
| -              | GND (Bank 3) | -               | -                                      |
| AA35           | BK3_IO3      | -               | 94N                                    |
| AB39           | BK3_IO4      | -               | 95P                                    |
| AB38           | BK3_IO5      | -               | 95N                                    |
| AA36           | BK3_IO6      | -               | 96P                                    |
| AB37           | BK3_IO7      | -               | 96N                                    |
| AC39           | BK3_IO8      | -               | 97P                                    |
| AC38           | BK3_IO9      | -               | 97N                                    |
| AB36           | BK3_IO10     | -               | 98P                                    |
| -              | GND (Bank 3) | -               | -                                      |
| AC37           | BK3_IO11     | -               | 98N                                    |
| AC36           | BK3_IO12     | -               | 99P                                    |
| AD39           | BK3_IO13     | -               | 99N                                    |
| AD37           | BK3_IO14     | -               | 100P                                   |
| AD36           | BK3_IO15     | -               | 100N                                   |
| AD35           | BK3_IO16     | -               | 101P                                   |
| AE38           | BK3_IO17     | -               | 101N                                   |
| AD38           | BK3_IO18     | -               | 102P                                   |
| -              | GND (Bank 3) | -               | -                                      |
| AE39           | BK3_IO19     | -               | 102N                                   |
| AF38           | BK3_IO20     | -               | 103P                                   |
| AF37           | BK3_IO21     | -               | 103N                                   |
| AF39           | BK3_IO22     | -               | 104P                                   |
| AE36           | BK3_IO23     | -               | 104N                                   |
| AF36           | BK3_IO24     | -               | 105P                                   |
| AG38           | BK3_IO25     | -               | 105N                                   |
| AG39           | BK3_IO26     | -               | 106P                                   |
| -              | GND (Bank 3) | -               | -                                      |
| AG37           | BK3_IO27     | -               | 106N                                   |
| AH37           | BK3_IO28     | -               | 107P                                   |
| AH38           | BK3_IO29     | -               | 107N                                   |
| AG36           | BK3_IO30     | -               | 108P                                   |

**ispXPGA Logic Signal Connections: 680-Ball fpBGA (Cont.)**

| LFX1200        |              |                 |                                        |
|----------------|--------------|-----------------|----------------------------------------|
| 680-Ball fpBGA | Signal Name  | Second Function | LVDS Pair/sysHSI Reserved <sup>1</sup> |
| AH39           | BK3_IO31     | -               | 108N                                   |
| AK39           | BK3_IO32     | -               | 109P                                   |
| AK38           | BK3_IO33     | -               | 109N                                   |
| AF35           | BK3_IO34     | -               | 110P                                   |
| -              | GND (Bank 3) | -               | -                                      |
| AJ37           | BK3_IO35     | -               | 110N                                   |
| AH36           | BK3_IO36     | -               | 111P                                   |
| AM39           | BK3_IO37     | -               | 111N                                   |
| AL38           | BK3_IO38     | -               | 112P                                   |
| AL39           | BK3_IO39     | -               | 112N                                   |
| AJ36           | BK3_IO40     | -               | 113P                                   |
| AH35           | BK3_IO41     | -               | 113N                                   |
| AL37           | BK3_IO42     | -               | 114P                                   |
| -              | GND (Bank 3) | -               | -                                      |
| AN38           | BK3_IO43     | -               | 114N                                   |
| AM38           | BK3_IO44     | -               | 115P                                   |
| AK36           | BK3_IO45     | -               | 115N                                   |
| AM37           | BK3_IO46     | -               | 116P                                   |
| AN37           | BK3_IO47     | -               | 116N                                   |
| AN39           | BK3_IO48     | -               | 117P                                   |
| AL36           | BK3_IO49     | VREF3           | 117N                                   |
| AK35           | BK3_IO50     | -               | 118P                                   |
| -              | GND (Bank 3) | -               | -                                      |
| AP39           | BK3_IO51     | -               | 118N                                   |
| AM36           | BK3_IO52     | -               | 119P                                   |
| AP38           | BK3_IO53     | -               | 119N                                   |
| AR39           | BK3_IO54     | -               | 120P                                   |
| AN36           | BK3_IO55     | -               | 120N                                   |
| AM35           | BK3_IO56     | -               | 121P                                   |
| AR38           | BK3_IO57     | -               | 121N                                   |
| AP37           | BK3_IO58     | -               | 122P                                   |
| -              | GND (Bank 3) | -               | -                                      |
| AT39           | BK3_IO59     | -               | 122N                                   |
| AR37           | BK3_IO60     | -               | 123P                                   |
| AP36           | BK3_IO61     | -               | 123N                                   |
| AT38           | GSR          | -               | -                                      |
| AP35           | DXP          | -               | -                                      |
| AT37           | DXN          | -               | -                                      |
| AU36           | BK4_IO0      | -               | 124P                                   |
| AV36           | BK4_IO1      | -               | 124N                                   |
| AR34           | BK4_IO2      | -               | 125P                                   |
| -              | GND (Bank 4) | -               | -                                      |
| AW36           | BK4_IO3      | -               | 125N                                   |

**ispXPGA Logic Signal Connections: 680-Ball fpBGA (Cont.)**

| LFX1200        |              |                 |                                        |
|----------------|--------------|-----------------|----------------------------------------|
| 680-Ball fpBGA | Signal Name  | Second Function | LVDS Pair/sysHSI Reserved <sup>1</sup> |
| AW35           | BK4_IO4      | -               | 126P                                   |
| AV35           | BK4_IO5      | -               | 126N                                   |
| AV34           | BK4_IO6      | HSI5A_SINP      | 127P                                   |
| AU34           | BK4_IO7      | HSI5A_SINN      | 127N                                   |
| AT34           | BK4_IO8      | -               | 128P                                   |
| AU35           | BK4_IO9      | -               | 128N                                   |
| AT33           | BK4_IO10     | HSI5A_SOUTP     | 129P/HSI5                              |
| -              | GND (Bank 4) | -               | -                                      |
| AU33           | BK4_IO11     | HSI5A_SOUTN     | 129N/HSI5                              |
| AW34           | BK4_IO12     | VREF4           | 130P/HSI5                              |
| AV33           | BK4_IO13     | -               | 130N/HSI5                              |
| AR32           | BK4_IO14     | HSI5B_SINP      | 131P/HSI5                              |
| AT32           | BK4_IO15     | HSI5B_SINN      | 131N/HSI5                              |
| AU32           | BK4_IO16     | -               | 132P/HSI5                              |
| AW33           | BK4_IO17     | -               | 132N/HSI5                              |
| AV32           | BK4_IO18     | HSI5B_SOUTP     | 133P/HSI5                              |
| -              | GND (Bank 4) | -               | -                                      |
| AV31           | BK4_IO19     | HSI5B_SOUTN     | 133N/HSI5                              |
| AU31           | BK4_IO20     | -               | 134P/HSI5                              |
| AW32           | BK4_IO21     | -               | 134N/HSI5                              |
| AR30           | BK4_IO22     | HSI6A_SINP      | 135P/HSI5                              |
| AT31           | BK4_IO23     | HSI6A_SINN      | 135N/HSI5                              |
| AW31           | BK4_IO24     | -               | 136P/HSI5                              |
| AV30           | BK4_IO25     | -               | 136N/HSI5                              |
| AT30           | BK4_IO26     | HSI6A_SOUTP     | 137P/HSI6                              |
| -              | GND (Bank 4) | -               | -                                      |
| AT29           | BK4_IO27     | HSI6A_SOUTN     | 137N/HSI6                              |
| AW30           | BK4_IO28     | -               | 138P/HSI6                              |
| AU29           | BK4_IO29     | -               | 138N/HSI6                              |
| AT28           | BK4_IO30     | HSI6B_SINP      | 139P/HSI6                              |
| AU28           | BK4_IO31     | HSI6B_SINN      | 139N/HSI6                              |
| AV28           | BK4_IO32     | -               | 140P/HSI6                              |
| AT27           | BK4_IO33     | -               | 140N/HSI6                              |
| AU27           | BK4_IO34     | HSI6B_SOUTP     | 141P/HSI6                              |
| -              | GND (Bank 4) | -               | -                                      |
| AV27           | BK4_IO35     | HSI6B_SOUTN     | 141N/HSI6                              |
| AW28           | BK4_IO36     | -               | 142P/HSI6                              |
| AR26           | BK4_IO37     | -               | 142N/HSI6                              |
| AW27           | BK4_IO38     | -               | 143P/HSI6                              |
| AT26           | BK4_IO39     | -               | 143N/HSI6                              |
| AV26           | BK4_IO40     | -               | 144P/HSI6                              |
| AR24           | BK4_IO41     | -               | 144N/HSI6                              |
| AT25           | BK4_IO42     | -               | 145P/HSI6                              |

**ispXPGA Logic Signal Connections: 680-Ball fpBGA (Cont.)**

| LFX1200        |              |                 |                                        |
|----------------|--------------|-----------------|----------------------------------------|
| 680-Ball fpBGA | Signal Name  | Second Function | LVDS Pair/sysHSI Reserved <sup>1</sup> |
| -              | GND (Bank 4) | -               | -                                      |
| AW26           | BK4_IO43     | -               | 145N                                   |
| AV25           | BK4_IO44     | -               | 146P                                   |
| AT24           | BK4_IO45     | -               | 146N                                   |
| AU24           | BK4_IO46     | -               | 147P                                   |
| AU25           | BK4_IO47     | -               | 147N                                   |
| AW25           | BK4_IO48     | PLL_RST4        | 148P                                   |
| AW24           | BK4_IO49     | PLL_RST5        | 148N                                   |
| AU23           | BK4_IO50     | -               | 149P                                   |
| -              | GND (Bank 4) | -               | -                                      |
| AT23           | BK4_IO51     | -               | 149N                                   |
| AV24           | BK4_IO52     | -               | 150P                                   |
| AW23           | BK4_IO53     | -               | 150N                                   |
| AV23           | BK4_IO54     | SS_CLKIN1P      | 151P                                   |
| AU22           | BK4_IO55     | SS_CLKIN1N      | 151N                                   |
| AR21           | BK4_IO56     | PLL_FBK4        | 152P                                   |
| AT22           | BK4_IO57     | PLL_FBK5        | 152N                                   |
| AV22           | BK4_IO58     | SS_CLKOUT1P     | 153P                                   |
| -              | GND (Bank 4) | -               | -                                      |
| AV21           | BK4_IO59     | SS_CLKOUT1N     | 153N                                   |
| AT21           | BK4_IO60     | CLK_OUT4        | 154P                                   |
| AU21           | BK4_IO61     | CLK_OUT5        | 154N                                   |
| -              | GND (Bank 4) | -               | -                                      |
| AT19           | GCLK4        | -               | LVDS Pair2P                            |
| AU19           | GCLK5        | -               | LVDS Pair2N                            |
| AW22           | VCCP1        | -               | -                                      |
| AR20           | GNDP1        | -               | -                                      |
| AU18           | GCLK6        | -               | LVDS Pair3P                            |
| AT18           | GCLK7        | -               | LVDS Pair3N                            |
| -              | GND (Bank 5) | -               | -                                      |
| AV17           | BK5_IO0      | CLK_OUT6        | 155P                                   |
| AV18           | BK5_IO1      | CLK_OUT7        | 155N                                   |
| AW21           | BK5_IO2      | PLL_FBK6        | 156P                                   |
| -              | GND (Bank 5) | -               | -                                      |
| AV19           | BK5_IO3      | PLL_FBK7        | 156N                                   |
| AR19           | BK5_IO4      | -               | 157P/HSI7                              |
| AW19           | BK5_IO5      | -               | 157N/HSI7                              |
| AW18           | BK5_IO6      | PLL_RST6        | 158P/HSI7                              |
| AW17           | BK5_IO7      | PLL_RST7        | 158N/HSI7                              |
| AT17           | BK5_IO8      | -               | 159P/HSI7                              |
| AV16           | BK5_IO9      | -               | 159N/HSI7                              |
| AU17           | BK5_IO10     | HSI7A_SINP      | 160P/HSI7                              |
| -              | GND (Bank 5) | -               | -                                      |

**ispXPGA Logic Signal Connections: 680-Ball fpBGA (Cont.)**

| LFX1200        |              |                 |                                        |
|----------------|--------------|-----------------|----------------------------------------|
| 680-Ball fpBGA | Signal Name  | Second Function | LVDS Pair/sysHSI Reserved <sup>1</sup> |
| AT16           | BK5_IO11     | HSI7A_SINN      | 160N/HSI7                              |
| AW16           | BK5_IO12     | -               | 161P/HSI7                              |
| AU16           | BK5_IO13     | -               | 161N/HSI7                              |
| AV14           | BK5_IO14     | HSI7A_SOUTP     | 162P/HSI7                              |
| AV15           | BK5_IO15     | HSI7A_SOUTN     | 162N/HSI7                              |
| AU15           | BK5_IO16     | -               | 163P/HSI7                              |
| AW15           | BK5_IO17     | -               | 163N/HSI7                              |
| AT15           | BK5_IO18     | HSI7B_SINP      | 164P/HSI7                              |
| -              | GND (Bank 5) | -               | -                                      |
| AR16           | BK5_IO19     | HSI7B_SINN      | 164N/HSI7                              |
| AW14           | BK5_IO20     | -               | 165P/HSI8                              |
| AW13           | BK5_IO21     | -               | 165N/HSI8                              |
| AR14           | BK5_IO22     | HSI7B_SOUTP     | 166P/HSI8                              |
| AT14           | BK5_IO23     | HSI7B_SOUTN     | 166N/HSI8                              |
| AT13           | BK5_IO24     | -               | 167P/HSI8                              |
| AV13           | BK5_IO25     | -               | 167N/HSI8                              |
| AU12           | BK5_IO26     | HSI8A_SINP      | 168P/HSI8                              |
| -              | GND (Bank 5) | -               | -                                      |
| AU13           | BK5_IO27     | HSI8A_SINN      | 168N/HSI8                              |
| AV12           | BK5_IO28     | -               | 169P/HSI8                              |
| AT12           | BK5_IO29     | -               | 169N/HSI8                              |
| AR12           | BK5_IO30     | HSI8A_SOUTP     | 170P/HSI8                              |
| AT11           | BK5_IO31     | HSI8A_SOUTN     | 170N/HSI8                              |
| AW12           | BK5_IO32     | -               | 171P/HSI8                              |
| AU11           | BK5_IO33     | -               | 171N/HSI8                              |
| AV9            | BK5_IO34     | HSI8B_SINP      | 172P/HSI8                              |
| -              | GND (Bank 5) | -               | -                                      |
| AV10           | BK5_IO35     | HSI8B_SINN      | 172N/HSI8                              |
| AW10           | BK5_IO36     | -               | 173P/HSI9                              |
| AW9            | BK5_IO37     | -               | 173N/HSI9                              |
| AT10           | BK5_IO38     | HSI8B_SOUTP     | 174P/HSI9                              |
| AU9            | BK5_IO39     | HSI8B_SOUTN     | 174N/HSI9                              |
| AT9            | BK5_IO40     | -               | 175P/HSI9                              |
| AR10           | BK5_IO41     | -               | 175N/HSI9                              |
| AU8            | BK5_IO42     | HSI9A_SINP      | 176P/HSI9                              |
| -              | GND (Bank 5) | -               | -                                      |
| AV8            | BK5_IO43     | HSI9A_SINN      | 176N/HSI9                              |
| AW8            | BK5_IO44     | -               | 177P/HSI9                              |
| AW7            | BK5_IO45     | -               | 177N/HSI9                              |
| AU7            | BK5_IO46     | HSI9A_SOUTP     | 178P/HSI9                              |
| AT8            | BK5_IO47     | HSI9A_SOUTN     | 178N/HSI9                              |
| AV7            | BK5_IO48     | -               | 179P/HSI9                              |
| AW6            | BK5_IO49     | VREF5           | 179N/HSI9                              |

## ispXPGA Logic Signal Connections: 680-Ball fpBGA (Cont.)

| LFX1200        |              |                 |                                        |
|----------------|--------------|-----------------|----------------------------------------|
| 680-Ball fpBGA | Signal Name  | Second Function | LVDS Pair/sysHSI Reserved <sup>1</sup> |
| AU6            | BK5_IO50     | HSI9B_SINP      | 180P/HSI9                              |
| -              | GND (Bank 5) | -               | -                                      |
| AV6            | BK5_IO51     | HSI9B_SINN      | 180N/HSI9                              |
| AR8            | BK5_IO52     | -               | 181P                                   |
| AT7            | BK5_IO53     | -               | 181N                                   |
| AU5            | BK5_IO54     | HSI9B_SOUTP     | 182P                                   |
| AV5            | BK5_IO55     | HSI9B_SOUTN     | 182N                                   |
| AW5            | BK5_IO56     | -               | 183P                                   |
| AW4            | BK5_IO57     | -               | 183N                                   |
| AT6            | BK5_IO58     | -               | 184P                                   |
| -              | GND (Bank 5) | -               | -                                      |
| AV4            | BK5_IO59     | -               | 184N                                   |
| AR6            | BK5_IO60     | -               | 185P                                   |
| AU4            | BK5_IO61     | -               | 185N                                   |
| AT1            | CFG0         | -               | -                                      |
| AT3            | DONE         | -               | -                                      |
| AT2            | PROGRAMb     | -               | -                                      |
| AP4            | BK6_IO0      | INITb           | 186P                                   |
| AP5            | BK6_IO1      | CCLK            | 186N                                   |
| AR3            | BK6_IO2      | -               | 187P                                   |
| -              | GND (Bank 6) | -               | -                                      |
| AR2            | BK6_IO3      | -               | 187N                                   |
| AP3            | BK6_IO4      | CSb             | 188P                                   |
| AR1            | BK6_IO5      | Read            | 188N                                   |
| AP2            | BK6_IO6      | -               | 189P                                   |
| AP1            | BK6_IO7      | -               | 189N                                   |
| AN4            | BK6_IO8      | -               | 190P                                   |
| AM5            | BK6_IO9      | -               | 190N                                   |
| AN3            | BK6_IO10     | -               | 191P                                   |
| -              | GND (Bank 6) | -               | -                                      |
| AN2            | BK6_IO11     | -               | 191N                                   |
| AM4            | BK6_IO12     | VREF6           | 192P                                   |
| AM3            | BK6_IO13     | -               | 192N                                   |
| AN1            | BK6_IO14     | -               | 193P                                   |
| AM2            | BK6_IO15     | -               | 193N                                   |
| AL4            | BK6_IO16     | -               | 194P                                   |
| AK5            | BK6_IO17     | -               | 194N                                   |
| AM1            | BK6_IO18     | -               | 195P                                   |
| -              | GND (Bank 6) | -               | -                                      |
| AK4            | BK6_IO19     | -               | 195N                                   |
| AL3            | BK6_IO20     | -               | 196P                                   |
| AL2            | BK6_IO21     | -               | 196N                                   |
| AL1            | BK6_IO22     | -               | 197P                                   |

**ispXPGA Logic Signal Connections: 680-Ball fpBGA (Cont.)**

| LFX1200        |              |                 |                                        |
|----------------|--------------|-----------------|----------------------------------------|
| 680-Ball fpBGA | Signal Name  | Second Function | LVDS Pair/sysHSI Reserved <sup>1</sup> |
| AK2            | BK6_IO23     | -               | 197N                                   |
| AK1            | BK6_IO24     | -               | 198P                                   |
| AJ4            | BK6_IO25     | -               | 198N                                   |
| AJ3            | BK6_IO26     | -               | 199P                                   |
| -              | GND (Bank 6) | -               | -                                      |
| AH4            | BK6_IO27     | -               | 199N                                   |
| AH3            | BK6_IO28     | -               | 200P                                   |
| AH2            | BK6_IO29     | -               | 200N                                   |
| AH1            | BK6_IO30     | -               | 201P                                   |
| AG4            | BK6_IO31     | -               | 201N                                   |
| AF5            | BK6_IO32     | DATA7           | 202P                                   |
| AG3            | BK6_IO33     | DATA6           | 202N                                   |
| AG2            | BK6_IO34     | -               | 203P                                   |
| -              | GND (Bank 6) | -               | -                                      |
| AF4            | BK6_IO35     | -               | 203N                                   |
| AF3            | BK6_IO36     | DATA5           | 204P                                   |
| AG1            | BK6_IO37     | DATA4           | 204N                                   |
| AE2            | BK6_IO38     | -               | 205P                                   |
| AF1            | BK6_IO39     | -               | 205N                                   |
| AF2            | BK6_IO40     | -               | 206P                                   |
| AE1            | BK6_IO41     | -               | 206N                                   |
| AE4            | BK6_IO42     | -               | 207P                                   |
| -              | GND (Bank 6) | -               | -                                      |
| AD4            | BK6_IO43     | -               | 207N                                   |
| AD5            | BK6_IO44     | -               | 208P                                   |
| AD3            | BK6_IO45     | -               | 208N                                   |
| AD2            | BK6_IO46     | -               | 209P                                   |
| AD1            | BK6_IO47     | -               | 209N                                   |
| AC4            | BK6_IO48     | -               | 210P                                   |
| AC3            | BK6_IO49     | -               | 210N                                   |
| AC2            | BK6_IO50     | DATA3           | 211P                                   |
| -              | GND (Bank 6) | -               | -                                      |
| AC1            | BK6_IO51     | DATA2           | 211N                                   |
| AB3            | BK6_IO52     | -               | 212P                                   |
| AB4            | BK6_IO53     | -               | 212N                                   |
| AB2            | BK6_IO54     | DATA1           | 213P                                   |
| AB1            | BK6_IO55     | DATA0           | 213N                                   |
| AA3            | BK6_IO56     | -               | 214P                                   |
| AA4            | BK6_IO57     | -               | 214N                                   |
| AA5            | BK6_IO58     | -               | 215P                                   |
| -              | GND (Bank 6) | -               | -                                      |
| AA2            | BK6_IO59     | -               | 215N                                   |
| AA1            | BK6_IO60     | -               | 216P                                   |

**ispXPGA Logic Signal Connections: 680-Ball fpBGA (Cont.)**

| LFX1200        |              |                 |                                        |
|----------------|--------------|-----------------|----------------------------------------|
| 680-Ball fpBGA | Signal Name  | Second Function | LVDS Pair/sysHSI Reserved <sup>1</sup> |
| Y5             | BK6_IO61     | -               | 216N                                   |
| -              | GND (Bank 6) | -               | -                                      |
| -              | GND (Bank 7) | -               | -                                      |
| W3             | BK7_IO0      | -               | 217P                                   |
| W1             | BK7_IO1      | -               | 217N                                   |
| W2             | BK7_IO2      | -               | 218P                                   |
| -              | GND (Bank 7) | -               | -                                      |
| W4             | BK7_IO3      | -               | 218N                                   |
| V1             | BK7_IO4      | -               | 219P                                   |
| V2             | BK7_IO5      | -               | 219N                                   |
| V3             | BK7_IO6      | -               | 220P                                   |
| V4             | BK7_IO7      | -               | 220N                                   |
| W5             | BK7_IO8      | -               | 221P                                   |
| U1             | BK7_IO9      | -               | 221N                                   |
| U2             | BK7_IO10     | -               | 222P                                   |
| -              | GND (Bank 7) | -               | -                                      |
| U3             | BK7_IO11     | -               | 222N                                   |
| U4             | BK7_IO12     | -               | 223P                                   |
| T1             | BK7_IO13     | -               | 223N                                   |
| T2             | BK7_IO14     | -               | 224P                                   |
| T3             | BK7_IO15     | -               | 224N                                   |
| R1             | BK7_IO16     | -               | 225P                                   |
| R2             | BK7_IO17     | -               | 225N                                   |
| T4             | BK7_IO18     | -               | 226P                                   |
| -              | GND (Bank 7) | -               | -                                      |
| P1             | BK7_IO19     | -               | 226N                                   |
| P2             | BK7_IO20     | -               | 227P                                   |
| P3             | BK7_IO21     | -               | 227N                                   |
| R4             | BK7_IO22     | -               | 228P                                   |
| T5             | BK7_IO23     | -               | 228N                                   |
| M1             | BK7_IO24     | -               | 229P                                   |
| M2             | BK7_IO25     | -               | 229N                                   |
| N3             | BK7_IO26     | -               | 230P                                   |
| -              | GND (Bank 7) | -               | -                                      |
| P4             | BK7_IO27     | -               | 230N                                   |
| L1             | BK7_IO28     | -               | 231P                                   |
| M3             | BK7_IO29     | -               | 231N                                   |
| L2             | BK7_IO30     | -               | 232P                                   |
| N4             | BK7_IO31     | -               | 232N                                   |
| K1             | BK7_IO32     | -               | 233P                                   |
| K2             | BK7_IO33     | -               | 233N                                   |
| P5             | BK7_IO34     | -               | 234P                                   |
| -              | GND (Bank 7) | -               | -                                      |



## ispXPGA Logic Signal Connections: 680-Ball fpBGA (Cont.)

| LFX1200        |              |                 |                                        |
|----------------|--------------|-----------------|----------------------------------------|
| 680-Ball fpBGA | Signal Name  | Second Function | LVDS Pair/sysHSI Reserved <sup>1</sup> |
| L3             | BK7_IO35     | -               | 234N                                   |
| J1             | BK7_IO36     | -               | 235P                                   |
| J2             | BK7_IO37     | -               | 235N                                   |
| M4             | BK7_IO38     | -               | 236P                                   |
| H1             | BK7_IO39     | -               | 236N                                   |
| J3             | BK7_IO40     | -               | 237P                                   |
| L4             | BK7_IO41     | -               | 237N                                   |
| M5             | BK7_IO42     | -               | 238P                                   |
| -              | GND (Bank 7) | -               | -                                      |
| H2             | BK7_IO43     | -               | 238N                                   |
| K4             | BK7_IO44     | -               | 239P                                   |
| G1             | BK7_IO45     | -               | 239N                                   |
| H3             | BK7_IO46     | -               | 240P                                   |
| J4             | BK7_IO47     | VREF7           | 240N                                   |
| K5             | BK7_IO48     | -               | 241P                                   |
| G3             | BK7_IO49     | -               | 241N                                   |
| H4             | BK7_IO50     | -               | 242P                                   |
| -              | GND (Bank 7) | -               | -                                      |
| F2             | BK7_IO51     | -               | 242N                                   |
| G2             | BK7_IO52     | -               | 243P                                   |
| H5             | BK7_IO53     | -               | 243N                                   |
| F3             | BK7_IO54     | -               | 244P                                   |
| F1             | BK7_IO55     | -               | 244N                                   |
| G4             | BK7_IO56     | -               | 245P                                   |
| E1             | BK7_IO57     | -               | 245N                                   |
| F4             | BK7_IO58     | -               | 246P                                   |
| -              | GND (Bank 7) | -               | -                                      |
| E2             | BK7_IO59     | -               | 246N                                   |
| F5             | BK7_IO60     | -               | 247P                                   |
| E3             | BK7_IO61     | -               | 247N                                   |
| D2             | TDO          | -               | -                                      |
| D3             | VCCJ         | -               | -                                      |
| D1             | TDI          | -               | -                                      |

1. If a sysHSI Block is used, the indicated sysHSI reserved pins are unavailable for general purpose I/O use.

ispXPGA Logic Signal Connections: 900-Ball fpBGA

| 900 fpBGA Ball | LFX1200      |                 |                                         | LFX500       |                 |                                         |
|----------------|--------------|-----------------|-----------------------------------------|--------------|-----------------|-----------------------------------------|
|                | Signal Name  | Second Function | LVDS Pair/ sysHSI Reserved <sup>1</sup> | Signal Name  | Second Function | LVDS Pair/ sysHSI Reserved <sup>1</sup> |
| D3             | BK0_IO0      | -               | 0P                                      | NC           | -               | -                                       |
| E3             | BK0_IO1      | -               | 0N                                      | NC           | -               | -                                       |
| C2             | BK0_IO2      | -               | 1P                                      | NC           | -               | -                                       |
| -              | GND (Bank 0) | -               | -                                       | -            | -               | -                                       |
| C1             | BK0_IO3      | -               | 1N                                      | NC           | -               | -                                       |
| E4             | BK0_IO4      | -               | 2P                                      | BK0_IO0      | -               | 0P                                      |
| F5             | BK0_IO5      | -               | 2N                                      | BK0_IO1      | -               | 0N                                      |
| D2             | BK0_IO6      | HSI0A_SOUTP     | 3P                                      | BK0_IO2      | HSI0A_SOUTP     | 1P/HSI0                                 |
| -              | -            | -               | -                                       | GND (Bank 0) | -               | -                                       |
| D1             | BK0_IO7      | HSI0A_SOUTN     | 3N                                      | BK0_IO3      | HSI0A_SOUTN     | 1N/HSI0                                 |
| F4             | BK0_IO8      | -               | 4P                                      | BK0_IO4      | -               | 2P/HSI0                                 |
| F3             | BK0_IO9      | -               | 4N                                      | BK0_IO5      | -               | 2N/HSI0                                 |
| E2             | BK0_IO10     | HSI0A_SINP      | 5P/HSI0                                 | BK0_IO6      | HSI0A_SINP      | 3P/HSI0                                 |
| -              | GND (Bank 0) | -               | -                                       | -            | -               | -                                       |
| E1             | BK0_IO11     | HSI0A_SINN      | 5N/HSI0                                 | BK0_IO7      | HSI0A_SINN      | 3N/HSI0                                 |
| G6             | BK0_IO12     | VREF0           | 6P/HSI0                                 | BK0_IO9      | VREF0           | 4N/HSI0                                 |
| G5             | BK0_IO13     | -               | 6N/HSI0                                 | BK0_IO8      | -               | 4P/HSI0                                 |
| F1             | BK0_IO14     | HSI0B_SOUTP     | 7P/HSI0                                 | NC           | -               | -                                       |
| F2             | BK0_IO15     | HSI0B_SOUTN     | 7N/HSI0                                 | NC           | -               | -                                       |
| G4             | BK0_IO16     | -               | 8P/HSI0                                 | NC           | -               | -                                       |
| G3             | BK0_IO17     | -               | 8N/HSI0                                 | NC           | -               | -                                       |
| G2             | BK0_IO18     | HSI0B_SINP      | 9P/HSI0                                 | NC           | -               | -                                       |
| -              | GND (Bank 0) | -               | -                                       | -            | -               | -                                       |
| G1             | BK0_IO19     | HSI0B_SINN      | 9N/HSI0                                 | NC           | -               | -                                       |
| H3             | BK0_IO20     | -               | 10P/HSI0                                | NC           | -               | -                                       |
| H4             | BK0_IO21     | -               | 10N/HSI0                                | NC           | -               | -                                       |
| H1             | BK0_IO22     | HSI1A_SOUTP     | 11P/HSI0                                | NC           | -               | -                                       |
| H2             | BK0_IO23     | HSI1A_SOUTN     | 11N/HSI0                                | NC           | -               | -                                       |
| J7             | BK0_IO24     | -               | 12P/HSI0                                | NC           | -               | -                                       |
| J6             | BK0_IO25     | -               | 12N/HSI0                                | NC           | -               | -                                       |
| J1             | BK0_IO26     | HSI1A_SINP      | 13P/HSI1                                | NC           | -               | -                                       |
| -              | GND (Bank 0) | -               | -                                       | -            | -               | -                                       |
| J2             | BK0_IO27     | HSI1A_SINN      | 13N/HSI1                                | NC           | -               | -                                       |
| J4             | BK0_IO28     | -               | 14P/HSI1                                | NC           | -               | -                                       |
| J5             | BK0_IO29     | -               | 14N/HSI1                                | NC           | -               | -                                       |
| K1             | BK0_IO30     | HSI1B_SOUTP     | 15P/HSI1                                | BK0_IO10     | HSI0B_SOUTP     | 5P/HSI0                                 |
| -              | -            | -               | -                                       | GND (Bank 0) | -               | -                                       |
| K2             | BK0_IO31     | HSI1B_SOUTN     | 15N/HSI1                                | BK0_IO11     | HSI0B_SOUTN     | 5N/HSI0                                 |
| K5             | BK0_IO32     | -               | 16P/HSI1                                | BK0_IO12     | -               | 6P/HSI0                                 |
| K4             | BK0_IO33     | -               | 16N/HSI1                                | BK0_IO13     | -               | 6N/HSI0                                 |
| L1             | BK0_IO34     | HSI1B_SINP      | 17P/HSI1                                | BK0_IO14     | HSI0B_SINP      | 7P/HSI0                                 |
| -              | GND (Bank 0) | -               | -                                       | -            | -               | -                                       |

ispXPGA Logic Signal Connections: 900-Ball fpBGA (Cont.)

| 900 fpBGA Ball | LFX1200      |                 |                                         | LFX500       |                 |                                         |
|----------------|--------------|-----------------|-----------------------------------------|--------------|-----------------|-----------------------------------------|
|                | Signal Name  | Second Function | LVDS Pair/ sysHSI Reserved <sup>1</sup> | Signal Name  | Second Function | LVDS Pair/ sysHSI Reserved <sup>1</sup> |
| L2             | BK0_IO35     | HSI1B_SINN      | 17N/HSI1                                | BK0_IO15     | HSI0B_SINN      | 7N/HSI0                                 |
| L6             | BK0_IO36     | -               | 18P/HSI1                                | BK0_IO16     | -               | 8P/HSI0                                 |
| L5             | BK0_IO37     | -               | 18N/HSI1                                | BK0_IO17     | -               | 8N/HSI0                                 |
| M1             | BK0_IO38     | HSI2A_SOUTP     | 19P/HSI1                                | BK0_IO18     | HSI1A_SOUTP     | 9P/HSI1                                 |
| -              | -            | -               | -                                       | GND (Bank 0) | -               | -                                       |
| M2             | BK0_IO39     | HSI2A_SOUTN     | 19N/HSI1                                | BK0_IO19     | HSI1A_SOUTN     | 9N/HSI1                                 |
| L3             | BK0_IO40     | -               | 20P/HSI1                                | BK0_IO20     | -               | 10P/HSI1                                |
| L4             | BK0_IO41     | -               | 20N/HSI1                                | BK0_IO21     | -               | 10N/HSI1                                |
| M6             | BK0_IO42     | HSI2A_SINP      | 21P/HSI2                                | BK0_IO22     | HSI1A_SINP      | 11P/HSI1                                |
| -              | GND (Bank 0) | -               | -                                       | -            | -               | -                                       |
| M5             | BK0_IO43     | HSI2A_SINN      | 21N/HSI2                                | BK0_IO23     | HSI1A_SINN      | 11N/HSI1                                |
| M4             | BK0_IO44     | -               | 22P/HSI2                                | BK0_IO24     | -               | 12P/HSI1                                |
| M3             | BK0_IO45     | -               | 22N/HSI2                                | BK0_IO25     | -               | 12N/HSI1                                |
| N1             | BK0_IO46     | HSI2B_SOUTP     | 23P/HSI2                                | BK0_IO26     | HSI1B_SOUTP     | 13P/HSI1                                |
| -              | -            | -               | -                                       | GND (Bank 0) | -               | -                                       |
| N2             | BK0_IO47     | HSI2B_SOUTN     | 23N/HSI2                                | BK0_IO27     | HSI1B_SOUTN     | 13N/HSI1                                |
| N7             | BK0_IO48     | -               | 24P/HSI2                                | BK0_IO28     | -               | 14P/HSI1                                |
| N6             | BK0_IO49     | -               | 24N/HSI2                                | BK0_IO29     | -               | 14N/HSI1                                |
| P1             | BK0_IO50     | HSI2B_SINP      | 25P/HSI2                                | BK0_IO30     | HSI1B_SINP      | 15P/HSI1                                |
| -              | GND (Bank 0) | -               | -                                       | -            | -               | -                                       |
| P2             | BK0_IO51     | HSI2B_SINN      | 25N/HSI2                                | BK0_IO31     | HSI1B_SINN      | 15N/HSI1                                |
| N3             | BK0_IO52     | -               | 26P/HSI2                                | BK0_IO32     | -               | 16P/HSI1                                |
| N4             | BK0_IO53     | -               | 26N/HSI2                                | BK0_IO33     | -               | 16N/HSI1                                |
| P6             | BK0_IO54     | PLL_RST0        | 27P/HSI2                                | BK0_IO38     | PLL_RST0        | 19P                                     |
| P5             | BK0_IO55     | PLL_RST1        | 27N/HSI2                                | BK0_IO35     | PLL_RST1        | 17N                                     |
| P3             | BK0_IO56     | -               | 28P/HSI2                                | BK0_IO36     | -               | 18P                                     |
| P4             | BK0_IO57     | -               | 28N/HSI2                                | BK0_IO39     | -               | 19N                                     |
| R7             | BK0_IO58     | PLL_FBK0        | 29P                                     | BK0_IO34     | PLL_FBK0        | 17P                                     |
| -              | GND (Bank 0) | -               | -                                       | GND (Bank 0) | -               | -                                       |
| R6             | BK0_IO59     | PLL_FBK1        | 29N                                     | BK0_IO37     | PLL_FBK1        | 18N                                     |
| R1             | BK0_IO60     | CLK_OUT0        | 30P                                     | BK0_IO40     | CLK_OUT0        | 20P                                     |
| -              | -            | -               | -                                       | GND (Bank 0) | -               | -                                       |
| R2             | BK0_IO61     | CLK_OUT1        | 30N                                     | BK0_IO41     | CLK_OUT1        | 20N                                     |
| -              | GND (Bank 0) | -               | -                                       | -            | -               | -                                       |
| R3             | GCLK0        | -               | LVDS Pair0P                             | GCLK0        | -               | LVDS Pair0P                             |
| R4             | GCLK1        | -               | LVDS Pair0N                             | GCLK1        | -               | LVDS Pair0N                             |
| R5             | VCCP0        | -               | -                                       | VCCP0        | -               | -                                       |
| T3             | GNDP0        | -               | -                                       | GNDP0        | -               | -                                       |
| T4             | GCLK2        | -               | LVDS Pair1P                             | GCLK2        | -               | LVDS Pair1P                             |
| T5             | GCLK3        | -               | LVDS Pair1N                             | GCLK3        | -               | LVDS Pair1N                             |
| -              | GND (Bank 1) | -               | -                                       | -            | -               | -                                       |
| T2             | BK1_IO0      | CLK_OUT2        | 31P                                     | BK1_IO0      | CLK_OUT2        | 21P                                     |

## ispXPGA Logic Signal Connections: 900-Ball fpBGA (Cont.)

| 900 fpBGA Ball | LFX1200      |                 |                                            | LFX500       |                 |                                            |
|----------------|--------------|-----------------|--------------------------------------------|--------------|-----------------|--------------------------------------------|
|                | Signal Name  | Second Function | LVDS Pair/<br>sysHSI Reserved <sup>1</sup> | Signal Name  | Second Function | LVDS Pair/<br>sysHSI Reserved <sup>1</sup> |
| -              | -            | -               | -                                          | GND (Bank 1) | -               | -                                          |
| T1             | BK1_IO1      | CLK_OUT3        | 31N                                        | BK1_IO1      | CLK_OUT3        | 21N                                        |
| U2             | BK1_IO2      | SS_CLKOUT0P     | 32P                                        | BK1_IO2      | SS_CLKOUT0P     | 22P                                        |
| -              | GND (Bank 1) | -               | -                                          | -            | -               | -                                          |
| U1             | BK1_IO3      | SS_CLKOUT0N     | 32N                                        | BK1_IO3      | SS_CLKOUT0N     | 22N                                        |
| U3             | BK1_IO4      | PLL_FBK2        | 33P                                        | BK1_IO4      | PLL_FBK2        | 23P                                        |
| U4             | BK1_IO5      | PLL_FBK3        | 33N                                        | BK1_IO5      | PLL_FBK3        | 23N                                        |
| V1             | BK1_IO6      | SS_CLKIN0P      | 34P                                        | BK1_IO10     | SS_CLKIN0P      | 26P                                        |
| V2             | BK1_IO7      | SS_CLKIN0N      | 34N                                        | BK1_IO11     | SS_CLKIN0N      | 26N                                        |
| U5             | BK1_IO8      | -               | 35P                                        | BK1_IO12     | -               | 27P                                        |
| U6             | BK1_IO9      | -               | 35N                                        | BK1_IO13     | -               | 27N                                        |
| V4             | BK1_IO10     | -               | 36P                                        | BK1_IO6      | -               | 24P                                        |
| -              | GND (Bank 1) | -               | -                                          | GND (Bank 1) | -               | -                                          |
| V3             | BK1_IO11     | -               | 36N                                        | BK1_IO7      | -               | 24N                                        |
| V6             | BK1_IO12     | PLL_RST2        | 37P                                        | BK1_IO20     | PLL_RST2        | 31P                                        |
| V7             | BK1_IO13     | PLL_RST3        | 37N                                        | BK1_IO21     | PLL_RST3        | 31N                                        |
| W1             | BK1_IO14     | -               | 38P                                        | BK1_IO8      | -               | 25P                                        |
| W2             | BK1_IO15     | -               | 38N                                        | BK1_IO9      | -               | 25N                                        |
| W3             | BK1_IO16     | -               | 39P                                        | BK1_IO14     | -               | 28P                                        |
| -              | -            | -               | -                                          | GND (Bank 1) | -               | -                                          |
| W4             | BK1_IO17     | -               | 39N                                        | BK1_IO15     | -               | 28N                                        |
| W5             | BK1_IO18     | -               | 40P                                        | BK1_IO16     | -               | 29P                                        |
| -              | GND (Bank 1) | -               | -                                          | -            | -               | -                                          |
| W6             | BK1_IO19     | -               | 40N                                        | BK1_IO17     | -               | 29N                                        |
| Y6             | BK1_IO20     | -               | 41P/HSI3                                   | NC           | -               | -                                          |
| Y5             | BK1_IO21     | -               | 41N/HSI3                                   | NC           | -               | -                                          |
| Y4             | BK1_IO22     | -               | 42P/HSI3                                   | NC           | -               | -                                          |
| Y3             | BK1_IO23     | -               | 42N/HSI3                                   | NC           | -               | -                                          |
| AA5            | BK1_IO24     | -               | 43P/HSI3                                   | NC           | -               | -                                          |
| AA4            | BK1_IO25     | -               | 43N/HSI3                                   | NC           | -               | -                                          |
| Y2             | BK1_IO26     | HSI3A_SOUTP     | 44P/HSI3                                   | BK1_IO18     | HSI2A_SOUTP     | 30P                                        |
| -              | GND (Bank 1) | -               | -                                          | -            | -               | -                                          |
| Y1             | BK1_IO27     | HSI3A_SOUTN     | 44N/HSI3                                   | BK1_IO19     | HSI2A_SOUTN     | 30N                                        |
| AB7            | BK1_IO28     | -               | 45P/HSI3                                   | NC           | -               | -                                          |
| AB6            | BK1_IO29     | -               | 45N/HSI3                                   | NC           | -               | -                                          |
| AA2            | BK1_IO30     | HSI3A_SINP      | 46P/HSI3                                   | BK1_IO22     | HSI2A_SINP      | 32P                                        |
| -              | -            | -               | -                                          | GND (Bank 1) | -               | -                                          |
| AA1            | BK1_IO31     | HSI3A_SINN      | 46N/HSI3                                   | BK1_IO23     | HSI2A_SINN      | 32N                                        |
| AB5            | BK1_IO32     | -               | 47P/HSI3                                   | NC           | -               | -                                          |
| AB4            | BK1_IO33     | -               | 47N/HSI3                                   | NC           | -               | -                                          |
| AB2            | BK1_IO34     | HSI3B_SOUTP     | 48P/HSI3                                   | NC           | -               | -                                          |
| -              | GND (Bank 1) | -               | -                                          | -            | -               | -                                          |

ispXPGA Logic Signal Connections: 900-Ball fpBGA (Cont.)

| 900 fpBGA Ball | LFX1200      |                 |                                         | LFX500       |                 |                                         |
|----------------|--------------|-----------------|-----------------------------------------|--------------|-----------------|-----------------------------------------|
|                | Signal Name  | Second Function | LVDS Pair/ sysHSI Reserved <sup>1</sup> | Signal Name  | Second Function | LVDS Pair/ sysHSI Reserved <sup>1</sup> |
| AB1            | BK1_IO35     | HSI3B_SOUTN     | 48N/HSI3                                | NC           | -               | -                                       |
| AC6            | BK1_IO36     | -               | 49P/HSI4                                | NC           | -               | -                                       |
| AC5            | BK1_IO37     | -               | 49N/HSI4                                | NC           | -               | -                                       |
| AC2            | BK1_IO38     | HSI3B_SINP      | 50P/HSI4                                | NC           | -               | -                                       |
| AC1            | BK1_IO39     | HSI3B_SINN      | 50N/HSI4                                | NC           | -               | -                                       |
| AC4            | BK1_IO40     | -               | 51P/HSI4                                | NC           | -               | -                                       |
| AC3            | BK1_IO41     | -               | 51N/HSI4                                | NC           | -               | -                                       |
| AD2            | BK1_IO42     | HSI4A_SOUTP     | 52P/HSI4                                | NC           | -               | -                                       |
| -              | GND (Bank 1) | -               | -                                       | -            | -               | -                                       |
| AD1            | BK1_IO43     | HSI4A_SOUTN     | 52N/HSI4                                | NC           | -               | -                                       |
| AD3            | BK1_IO44     | -               | 53P/HSI4                                | BK1_IO32     | -               | 37P/HSI3                                |
| AD4            | BK1_IO45     | -               | 53N/HSI4                                | BK1_IO33     | -               | 37N                                     |
| AE2            | BK1_IO46     | HSI4A_SINP      | 54P/HSI4                                | BK1_IO34     | -               | 38P                                     |
| AE1            | BK1_IO47     | HSI4A_SINN      | 54N/HSI4                                | BK1_IO35     | -               | 38N                                     |
| AD5            | BK1_IO48     | -               | 55P/HSI4                                | BK1_IO25     | -               | 33N                                     |
| AD6            | BK1_IO49     | VREF1           | 55N/HSI4                                | BK1_IO24     | VREF1           | 33P                                     |
| AF2            | BK1_IO50     | HSI4B_SOUTP     | 56P/HSI4                                | BK1_IO26     | HSI2B_SOUTP     | 34P                                     |
| -              | GND (Bank 1) | -               | -                                       | -            | -               | -                                       |
| AF1            | BK1_IO51     | HSI4B_SOUTN     | 56N/HSI4                                | BK1_IO27     | HSI2B_SOUTN     | 34N                                     |
| AE3            | BK1_IO52     | -               | 57P                                     | BK1_IO28     | -               | 35P                                     |
| AE4            | BK1_IO53     | -               | 57N                                     | BK1_IO29     | -               | 35N                                     |
| AG1            | BK1_IO54     | HSI4B_SINP      | 58P                                     | BK1_IO30     | HSI2B_SINP      | 36P                                     |
| -              | -            | -               | -                                       | GND (Bank 1) | -               | -                                       |
| AG2            | BK1_IO55     | HSI4B_SINN      | 58N                                     | BK1_IO31     | HSI2B_SINN      | 36N                                     |
| AE5            | BK1_IO56     | -               | 59P                                     | BK1_IO36     | -               | 39P                                     |
| AF4            | BK1_IO57     | -               | 59N                                     | BK1_IO37     | -               | 39N                                     |
| AH1            | BK1_IO58     | -               | 60P                                     | BK1_IO38     | -               | 40P                                     |
| -              | GND (Bank 1) | -               | -                                       | GND (Bank 1) | -               | -                                       |
| AH2            | BK1_IO59     | -               | 60N                                     | BK1_IO39     | -               | 40N                                     |
| AF3            | BK1_IO60     | -               | 61P                                     | BK1_IO40     | -               | 41P                                     |
| AG3            | BK1_IO61     | -               | 61N                                     | BK1_IO41     | -               | 41N                                     |
| AH4            | TCK          | -               | -                                       | TCK          | -               | -                                       |
| AJ3            | TMS          | -               | -                                       | TMS          | -               | -                                       |
| AK3            | TOE          | -               | -                                       | TOE          | -               | -                                       |
| AG5            | BK2_IO0      | -               | 62P                                     | BK2_IO0      | -               | 42P                                     |
| AH5            | BK2_IO1      | -               | 62N                                     | BK2_IO1      | -               | 42N                                     |
| AJ4            | BK2_IO2      | -               | 63P                                     | BK2_IO2      | -               | 43P                                     |
| -              | GND (Bank 2) | -               | -                                       | GND (Bank 2) | -               | -                                       |
| AK4            | BK2_IO3      | -               | 63N                                     | BK2_IO3      | -               | 43N                                     |
| AG6            | BK2_IO4      | -               | 64P                                     | BK2_IO4      | -               | 44P                                     |
| AH6            | BK2_IO5      | -               | 64N                                     | BK2_IO5      | -               | 44N                                     |
| AJ5            | BK2_IO6      | -               | 65P                                     | BK2_IO6      | -               | 45P                                     |

ispXPGA Logic Signal Connections: 900-Ball fpBGA (Cont.)

| 900 fpBGA Ball | LFX1200      |                 |                                         | LFX500       |                 |                                         |
|----------------|--------------|-----------------|-----------------------------------------|--------------|-----------------|-----------------------------------------|
|                | Signal Name  | Second Function | LVDS Pair/ sysHSI Reserved <sup>1</sup> | Signal Name  | Second Function | LVDS Pair/ sysHSI Reserved <sup>1</sup> |
| AK5            | BK2_IO7      | -               | 65N                                     | BK2_IO7      | -               | 45N                                     |
| AE7            | BK2_IO8      | -               | 66P                                     | BK2_IO8      | -               | 46P                                     |
| AF7            | BK2_IO9      | -               | 66N                                     | BK2_IO9      | -               | 46N                                     |
| AG7            | BK2_IO10     | -               | 67P                                     | BK2_IO10     | -               | 47P                                     |
| -              | GND (Bank 2) | -               | -                                       | GND (Bank 2) | -               | -                                       |
| AH7            | BK2_IO11     | -               | 67N                                     | BK2_IO11     | -               | 47N                                     |
| AE8            | BK2_IO12     | VREF2           | 68P                                     | BK2_IO21     | VREF2           | 52N                                     |
| AF8            | BK2_IO13     | -               | 68N                                     | BK2_IO20     | -               | 52P                                     |
| AJ6            | BK2_IO14     | -               | 69P                                     | BK2_IO12     | -               | 48P                                     |
| AK6            | BK2_IO15     | -               | 69N                                     | BK2_IO13     | -               | 48N                                     |
| AG8            | BK2_IO16     | -               | 70P                                     | BK2_IO14     | -               | 49P                                     |
| AH8            | BK2_IO17     | -               | 70N                                     | BK2_IO15     | -               | 49N                                     |
| AJ7            | BK2_IO18     | -               | 71P                                     | BK2_IO16     | -               | 50P                                     |
| -              | GND (Bank 2) | -               | -                                       | -            | -               | -                                       |
| AK7            | BK2_IO19     | -               | 71N                                     | BK2_IO17     | -               | 50N                                     |
| AF9            | BK2_IO20     | -               | 72P                                     | BK2_IO18     | -               | 51P                                     |
| -              | -            | -               | -                                       | GND (Bank 2) | -               | -                                       |
| AG9            | BK2_IO21     | -               | 72N                                     | BK2_IO19     | -               | 51N                                     |
| AJ8            | BK2_IO22     | -               | 73P                                     | NC           | -               | -                                       |
| AK8            | BK2_IO23     | -               | 73N                                     | NC           | -               | -                                       |
| AD10           | BK2_IO24     | -               | 74P                                     | NC           | -               | -                                       |
| AE10           | BK2_IO25     | -               | 74N                                     | NC           | -               | -                                       |
| AJ9            | BK2_IO26     | -               | 75P                                     | NC           | -               | -                                       |
| -              | GND (Bank 2) | -               | -                                       | -            | -               | -                                       |
| AK9            | BK2_IO27     | -               | 75N                                     | NC           | -               | -                                       |
| AF10           | BK2_IO28     | -               | 76P                                     | NC           | -               | -                                       |
| AG10           | BK2_IO29     | -               | 76N                                     | NC           | -               | -                                       |
| AK10           | BK2_IO30     | -               | 77P                                     | NC           | -               | -                                       |
| AJ10           | BK2_IO31     | -               | 77N                                     | NC           | -               | -                                       |
| AE11           | BK2_IO32     | -               | 78P                                     | NC           | -               | -                                       |
| AF11           | BK2_IO33     | -               | 78N                                     | NC           | -               | -                                       |
| AG11           | BK2_IO34     | -               | 79P                                     | NC           | -               | -                                       |
| -              | GND (Bank 2) | -               | -                                       | -            | -               | -                                       |
| AH11           | BK2_IO35     | -               | 79N                                     | NC           | -               | -                                       |
| AE12           | BK2_IO36     | -               | 80P                                     | NC           | -               | -                                       |
| AF12           | BK2_IO37     | -               | 80N                                     | NC           | -               | -                                       |
| AJ11           | BK2_IO38     | -               | 81P                                     | NC           | -               | -                                       |
| AK11           | BK2_IO39     | -               | 81N                                     | NC           | -               | -                                       |
| AG12           | BK2_IO40     | -               | 82P                                     | NC           | -               | -                                       |
| AH12           | BK2_IO41     | -               | 82N                                     | NC           | -               | -                                       |
| AK12           | BK2_IO42     | -               | 83P                                     | BK2_IO22     | -               | 53P                                     |
| -              | GND (Bank 2) | -               | -                                       | -            | -               | -                                       |

ispXPGA Logic Signal Connections: 900-Ball fpBGA (Cont.)

| 900 fpBGA Ball | LFX1200      |                 |                                            | LFX500       |                 |                                            |
|----------------|--------------|-----------------|--------------------------------------------|--------------|-----------------|--------------------------------------------|
|                | Signal Name  | Second Function | LVDS Pair/<br>sysHSI Reserved <sup>1</sup> | Signal Name  | Second Function | LVDS Pair/<br>sysHSI Reserved <sup>1</sup> |
| AJ12           | BK2_IO43     | -               | 83N                                        | BK2_IO23     | -               | 53N                                        |
| AD13           | BK2_IO44     | -               | 84P                                        | BK2_IO24     | -               | 54P                                        |
| AE13           | BK2_IO45     | -               | 84N                                        | BK2_IO25     | -               | 54N                                        |
| AK13           | BK2_IO46     | -               | 85P                                        | BK2_IO26     | -               | 55P                                        |
| -              | -            | -               | -                                          | GND (Bank 2) | -               | -                                          |
| AJ13           | BK2_IO47     | -               | 85N                                        | BK2_IO27     | -               | 55N                                        |
| AG13           | BK2_IO48     | -               | 86P                                        | BK2_IO28     | -               | 56P                                        |
| AH13           | BK2_IO49     | -               | 86N                                        | BK2_IO29     | -               | 56N                                        |
| AE14           | BK2_IO50     | -               | 87P                                        | BK2_IO30     | -               | 57P                                        |
| -              | GND (Bank 2) | -               | -                                          | -            | -               | -                                          |
| AF14           | BK2_IO51     | -               | 87N                                        | BK2_IO31     | -               | 57N                                        |
| AG14           | BK2_IO52     | -               | 88P                                        | BK2_IO32     | -               | 58P                                        |
| AH14           | BK2_IO53     | -               | 88N                                        | BK2_IO33     | -               | 58N                                        |
| AJ14           | BK2_IO54     | -               | 89P                                        | BK2_IO34     | -               | 59P                                        |
| -              | -            | -               | -                                          | GND (Bank 2) | -               | -                                          |
| AK14           | BK2_IO55     | -               | 89N                                        | BK2_IO35     | -               | 59N                                        |
| AE15           | BK2_IO56     | -               | 90P                                        | BK2_IO36     | -               | 60P                                        |
| AF15           | BK2_IO57     | -               | 90N                                        | BK2_IO37     | -               | 60N                                        |
| AG15           | BK2_IO58     | -               | 91P                                        | BK2_IO38     | -               | 61P                                        |
| -              | GND (Bank 2) | -               | -                                          | -            | -               | -                                          |
| AH15           | BK2_IO59     | -               | 91N                                        | BK2_IO39     | -               | 61N                                        |
| AJ15           | BK2_IO60     | -               | 92P                                        | BK2_IO40     | -               | 62P                                        |
| AK15           | BK2_IO61     | -               | 92N                                        | BK2_IO41     | -               | 62N                                        |
| -              | GND (Bank 2) | -               | -                                          | GND (Bank 2) | -               | -                                          |
| -              | GND (Bank 3) | -               | -                                          | GND (Bank 3) | -               | -                                          |
| AK16           | BK3_IO0      | -               | 93P                                        | BK3_IO0      | -               | 63P                                        |
| AJ16           | BK3_IO1      | -               | 93N                                        | BK3_IO1      | -               | 63N                                        |
| AH16           | BK3_IO2      | -               | 94P                                        | BK3_IO2      | -               | 64P                                        |
| -              | GND (Bank 3) | -               | -                                          | -            | -               | -                                          |
| AG16           | BK3_IO3      | -               | 94N                                        | BK3_IO3      | -               | 64N                                        |
| AF16           | BK3_IO4      | -               | 95P                                        | BK3_IO4      | -               | 65P                                        |
| AE16           | BK3_IO5      | -               | 95N                                        | BK3_IO5      | -               | 65N                                        |
| AK17           | BK3_IO6      | -               | 96P                                        | BK3_IO6      | -               | 66P                                        |
| -              | -            | -               | -                                          | GND (Bank 3) | -               | -                                          |
| AJ17           | BK3_IO7      | -               | 96N                                        | BK3_IO7      | -               | 66N                                        |
| AH17           | BK3_IO8      | -               | 97P                                        | BK3_IO8      | -               | 67P                                        |
| AG17           | BK3_IO9      | -               | 97N                                        | BK3_IO9      | -               | 67N                                        |
| AF17           | BK3_IO10     | -               | 98P                                        | BK3_IO10     | -               | 68P                                        |
| -              | GND (Bank 3) | -               | -                                          | -            | -               | -                                          |
| AE17           | BK3_IO11     | -               | 98N                                        | BK3_IO11     | -               | 68N                                        |
| AH18           | BK3_IO12     | -               | 99P                                        | BK3_IO12     | -               | 69P                                        |
| AG18           | BK3_IO13     | -               | 99N                                        | BK3_IO13     | -               | 69N                                        |

ispXPGA Logic Signal Connections: 900-Ball fpBGA (Cont.)

| 900 fpBGA Ball | LFX1200      |                 |                                         | LFX500       |                 |                                         |
|----------------|--------------|-----------------|-----------------------------------------|--------------|-----------------|-----------------------------------------|
|                | Signal Name  | Second Function | LVDS Pair/ sysHSI Reserved <sup>1</sup> | Signal Name  | Second Function | LVDS Pair/ sysHSI Reserved <sup>1</sup> |
| AJ18           | BK3_IO14     | -               | 100P                                    | BK3_IO14     | -               | 70P                                     |
| -              | -            | -               | -                                       | GND (Bank 3) | -               | -                                       |
| AK18           | BK3_IO15     | -               | 100N                                    | BK3_IO15     | -               | 70N                                     |
| AE18           | BK3_IO16     | -               | 101P                                    | BK3_IO16     | -               | 71P                                     |
| AD18           | BK3_IO17     | -               | 101N                                    | BK3_IO17     | -               | 71N                                     |
| AJ19           | BK3_IO18     | -               | 102P                                    | BK3_IO18     | -               | 72P                                     |
| -              | GND (Bank 3) | -               | -                                       | -            | -               | -                                       |
| AK19           | BK3_IO19     | -               | 102N                                    | BK3_IO19     | -               | 72N                                     |
| AH19           | BK3_IO20     | -               | 103P                                    | NC           | -               | -                                       |
| AG19           | BK3_IO21     | -               | 103N                                    | NC           | -               | -                                       |
| AK20           | BK3_IO22     | -               | 104P                                    | NC           | -               | -                                       |
| AJ20           | BK3_IO23     | -               | 104N                                    | NC           | -               | -                                       |
| AF19           | BK3_IO24     | -               | 105P                                    | NC           | -               | -                                       |
| AE19           | BK3_IO25     | -               | 105N                                    | NC           | -               | -                                       |
| AH20           | BK3_IO26     | -               | 106P                                    | NC           | -               | -                                       |
| -              | GND (Bank 3) | -               | -                                       | -            | -               | -                                       |
| AG20           | BK3_IO27     | -               | 106N                                    | NC           | -               | -                                       |
| AF20           | BK3_IO28     | -               | 107P                                    | NC           | -               | -                                       |
| AE20           | BK3_IO29     | -               | 107N                                    | NC           | -               | -                                       |
| AJ21           | BK3_IO30     | -               | 108P                                    | NC           | -               | -                                       |
| AK21           | BK3_IO31     | -               | 108N                                    | NC           | -               | -                                       |
| AG21           | BK3_IO32     | -               | 109P                                    | NC           | -               | -                                       |
| AF21           | BK3_IO33     | -               | 109N                                    | NC           | -               | -                                       |
| AK22           | BK3_IO34     | -               | 110P                                    | NC           | -               | -                                       |
| -              | GND (Bank 3) | -               | -                                       | -            | -               | -                                       |
| AJ22           | BK3_IO35     | -               | 110N                                    | NC           | -               | -                                       |
| AE21           | BK3_IO36     | -               | 111P                                    | NC           | -               | -                                       |
| AD21           | BK3_IO37     | -               | 111N                                    | NC           | -               | -                                       |
| AG22           | BK3_IO38     | -               | 112P                                    | NC           | -               | -                                       |
| AF22           | BK3_IO39     | -               | 112N                                    | NC           | -               | -                                       |
| AG23           | BK3_IO40     | -               | 113P                                    | BK3_IO22     | -               | 74P                                     |
| -              | -            | -               | -                                       | GND (Bank 3) | -               | -                                       |
| AH23           | BK3_IO41     | -               | 113N                                    | BK3_IO23     | -               | 74N                                     |
| AJ23           | BK3_IO42     | -               | 114P                                    | BK3_IO24     | -               | 75P                                     |
| -              | GND (Bank 3) | -               | -                                       | -            | -               | -                                       |
| AK23           | BK3_IO43     | -               | 114N                                    | BK3_IO25     | -               | 75N                                     |
| AF23           | BK3_IO44     | -               | 115P                                    | BK3_IO26     | -               | 76P                                     |
| AE23           | BK3_IO45     | -               | 115N                                    | BK3_IO27     | -               | 76N                                     |
| AJ24           | BK3_IO46     | -               | 116P                                    | BK3_IO28     | -               | 77P                                     |
| AK24           | BK3_IO47     | -               | 116N                                    | BK3_IO29     | -               | 77N                                     |
| AH24           | BK3_IO48     | -               | 117P                                    | BK3_IO21     | -               | 73N                                     |
| AG24           | BK3_IO49     | VREF3           | 117N                                    | BK3_IO20     | VREF3           | 73P                                     |



ispXPGA Logic Signal Connections: 900-Ball fpBGA (Cont.)

| 900 fpBGA Ball | LFX1200      |                 |                                         | LFX500       |                 |                                         |
|----------------|--------------|-----------------|-----------------------------------------|--------------|-----------------|-----------------------------------------|
|                | Signal Name  | Second Function | LVDS Pair/ sysHSI Reserved <sup>1</sup> | Signal Name  | Second Function | LVDS Pair/ sysHSI Reserved <sup>1</sup> |
| AJ25           | BK3_IO50     | -               | 118P                                    | BK3_IO30     | -               | 78P                                     |
| -              | GND (Bank 3) | -               | -                                       | GND (Bank 3) | -               | -                                       |
| AK25           | BK3_IO51     | -               | 118N                                    | BK3_IO31     | -               | 78N                                     |
| AF24           | BK3_IO52     | -               | 119P                                    | BK3_IO32     | -               | 79P                                     |
| AE24           | BK3_IO53     | -               | 119N                                    | BK3_IO33     | -               | 79N                                     |
| AK26           | BK3_IO54     | -               | 120P                                    | BK3_IO34     | -               | 80P                                     |
| AJ26           | BK3_IO55     | -               | 120N                                    | BK3_IO35     | -               | 80N                                     |
| AH25           | BK3_IO56     | -               | 121P                                    | BK3_IO36     | -               | 81P                                     |
| AG25           | BK3_IO57     | -               | 121N                                    | BK3_IO37     | -               | 81N                                     |
| AK27           | BK3_IO58     | -               | 122P                                    | BK3_IO38     | -               | 82P                                     |
| -              | GND (Bank 3) | -               | -                                       | GND (Bank 3) | -               | -                                       |
| AJ27           | BK3_IO59     | -               | 122N                                    | BK3_IO39     | -               | 82N                                     |
| AG26           | BK3_IO60     | -               | 123P                                    | BK3_IO40     | -               | 83P                                     |
| AH26           | BK3_IO61     | -               | 123N                                    | BK3_IO41     | -               | 83N                                     |
| AK28           | GSR          | -               | -                                       | GSR          | -               | -                                       |
| AJ28           | DXP          | -               | -                                       | DXP          | -               | -                                       |
| AH27           | DXN          | -               | -                                       | DXN          | -               | -                                       |
| AG28           | BK4_IO0      | -               | 124P                                    | BK4_IO0      | -               | 84P                                     |
| AF27           | BK4_IO1      | -               | 124N                                    | BK4_IO1      | -               | 84N                                     |
| AF28           | BK4_IO2      | -               | 125P                                    | BK4_IO2      | -               | 85P/HSI3                                |
| -              | GND (Bank 4) | -               | -                                       | GND (Bank 4) | -               | -                                       |
| AE26           | BK4_IO3      | -               | 125N                                    | BK4_IO3      | -               | 85N/HSI3                                |
| AE27           | BK4_IO4      | -               | 126P                                    | BK4_IO4      | -               | 86P/HSI3                                |
| AE28           | BK4_IO5      | -               | 126N                                    | BK4_IO5      | -               | 86N/HSI3                                |
| AH30           | BK4_IO6      | HSI5A_SINP      | 127P                                    | BK4_IO10     | HSI3A_SINP      | 89P/HSI3                                |
| -              | -            | -               | -                                       | GND (Bank 4) | -               | -                                       |
| AH29           | BK4_IO7      | HSI5A_SINN      | 127N                                    | BK4_IO11     | HSI3A_SINN      | 89N/HSI3                                |
| AD25           | BK4_IO8      | -               | 128P                                    | BK4_IO12     | -               | 90P/HSI3                                |
| AD26           | BK4_IO9      | -               | 128N                                    | BK4_IO13     | -               | 90N/HSI3                                |
| AG29           | BK4_IO10     | HSI5A_SOUTP     | 129P/HSI5                               | BK4_IO14     | HSI3A_SOUTP     | 91P/HSI3                                |
| -              | GND (Bank 4) | -               | -                                       | -            | -               | -                                       |
| AG30           | BK4_IO11     | HSI5A_SOUTN     | 129N/HSI5                               | BK4_IO15     | HSI3A_SOUTN     | 91N/HSI3                                |
| AD27           | BK4_IO12     | VREF4           | 130P/HSI5                               | BK4_IO17     | VREF4           | 92N/HSI3                                |
| AD28           | BK4_IO13     | -               | 130N/HSI5                               | BK4_IO16     | -               | 92P/HSI3                                |
| AF29           | BK4_IO14     | HSI5B_SINP      | 131P/HSI5                               | BK4_IO6      | -               | 87P/HSI3                                |
| AF30           | BK4_IO15     | HSI5B_SINN      | 131N/HSI5                               | BK4_IO7      | -               | 87N/HSI3                                |
| AC25           | BK4_IO16     | -               | 132P/HSI5                               | BK4_IO8      | -               | 88P/HSI3                                |
| AC26           | BK4_IO17     | -               | 132N/HSI5                               | BK4_IO9      | -               | 88N/HSI3                                |
| AE29           | BK4_IO18     | HSI5B_SOUTP     | 133P/HSI5                               | NC           | -               | -                                       |
| -              | GND (Bank 4) | -               | -                                       | -            | -               | -                                       |
| AE30           | BK4_IO19     | HSI5B_SOUTN     | 133N/HSI5                               | NC           | -               | -                                       |
| AC28           | BK4_IO20     | -               | 134P/HSI5                               | NC           | -               | -                                       |

## ispXPGA Logic Signal Connections: 900-Ball fpBGA (Cont.)

| 900 fpBGA Ball | LFX1200      |                 |                                            | LFX500       |                 |                                            |
|----------------|--------------|-----------------|--------------------------------------------|--------------|-----------------|--------------------------------------------|
|                | Signal Name  | Second Function | LVDS Pair/<br>sysHSI Reserved <sup>1</sup> | Signal Name  | Second Function | LVDS Pair/<br>sysHSI Reserved <sup>1</sup> |
| AC27           | BK4_IO21     | -               | 134N/HSI5                                  | NC           | -               | -                                          |
| AD29           | BK4_IO22     | HSI6A_SINP      | 135P/HSI5                                  | NC           | -               | -                                          |
| AD30           | BK4_IO23     | HSI6A_SINN      | 135N/HSI5                                  | NC           | -               | -                                          |
| AB24           | BK4_IO24     | -               | 136P/HSI5                                  | NC           | -               | -                                          |
| AB25           | BK4_IO25     | -               | 136N/HSI5                                  | NC           | -               | -                                          |
| AC29           | BK4_IO26     | HSI6A_SOUTP     | 137P/HSI6                                  | NC           | -               | -                                          |
| -              | GND (Bank 4) | -               | -                                          | -            | -               | -                                          |
| AC30           | BK4_IO27     | HSI6A_SOUTN     | 137N/HSI6                                  | NC           | -               | -                                          |
| AB27           | BK4_IO28     | -               | 138P/HSI6                                  | NC           | -               | -                                          |
| AB26           | BK4_IO29     | -               | 138N/HSI6                                  | NC           | -               | -                                          |
| AB30           | BK4_IO30     | HSI6B_SINP      | 139P/HSI6                                  | BK4_IO18     | HSI3B_SINP      | 93P                                        |
| -              | -            | -               | -                                          | GND (Bank 4) | -               | -                                          |
| AB29           | BK4_IO31     | HSI6B_SINN      | 139N/HSI6                                  | BK4_IO19     | HSI3B_SINN      | 93N                                        |
| AA26           | BK4_IO32     | -               | 140P/HSI6                                  | NC           | -               | -                                          |
| AA27           | BK4_IO33     | -               | 140N/HSI6                                  | NC           | -               | -                                          |
| AA30           | BK4_IO34     | HSI6B_SOUTP     | 141P/HSI6                                  | BK4_IO22     | HSI3B_SOUTP     | 95P                                        |
| -              | GND (Bank 4) | -               | -                                          | -            | -               | -                                          |
| AA29           | BK4_IO35     | HSI6B_SOUTN     | 141N/HSI6                                  | BK4_IO23     | HSI3B_SOUTN     | 95N                                        |
| Y25            | BK4_IO36     | -               | 142P/HSI6                                  | NC           | -               | -                                          |
| Y26            | BK4_IO37     | -               | 142N/HSI6                                  | NC           | -               | -                                          |
| Y28            | BK4_IO38     | -               | 143P/HSI6                                  | NC           | -               | -                                          |
| Y27            | BK4_IO39     | -               | 143N/HSI6                                  | NC           | -               | -                                          |
| W25            | BK4_IO40     | -               | 144P/HSI6                                  | NC           | -               | -                                          |
| W26            | BK4_IO41     | -               | 144N/HSI6                                  | NC           | -               | -                                          |
| W27            | BK4_IO42     | -               | 145P                                       | BK4_IO24     | -               | 96P                                        |
| -              | GND (Bank 4) | -               | -                                          | -            | -               | -                                          |
| W28            | BK4_IO43     | -               | 145N                                       | BK4_IO25     | -               | 96N                                        |
| V24            | BK4_IO44     | -               | 146P                                       | BK4_IO26     | -               | 97P                                        |
| -              | -            | -               | -                                          | GND (Bank 4) | -               | -                                          |
| V25            | BK4_IO45     | -               | 146N                                       | BK4_IO27     | -               | 97N                                        |
| Y29            | BK4_IO46     | -               | 147P                                       | BK4_IO32     | -               | 100P                                       |
| Y30            | BK4_IO47     | -               | 147N                                       | BK4_IO33     | -               | 100N                                       |
| V27            | BK4_IO48     | PLL_RST4        | 148P                                       | BK4_IO20     | PLL_RST4        | 94P                                        |
| V28            | BK4_IO49     | PLL_RST5        | 148N                                       | BK4_IO21     | PLL_RST5        | 94N                                        |
| W29            | BK4_IO50     | -               | 149P                                       | BK4_IO34     | -               | 101P                                       |
| -              | GND (Bank 4) | -               | -                                          | GND (Bank 4) | -               | -                                          |
| W30            | BK4_IO51     | -               | 149N                                       | BK4_IO35     | -               | 101N                                       |
| U25            | BK4_IO52     | -               | 150P                                       | BK4_IO28     | -               | 98P                                        |
| U26            | BK4_IO53     | -               | 150N                                       | BK4_IO29     | -               | 98N                                        |
| V29            | BK4_IO54     | SS_CLKIN1P      | 151P                                       | BK4_IO30     | SS_CLKIN1P      | 99P                                        |
| V30            | BK4_IO55     | SS_CLKIN1N      | 151N                                       | BK4_IO31     | SS_CLKIN1N      | 99N                                        |
| U28            | BK4_IO56     | PLL_FBK4        | 152P                                       | BK4_IO36     | PLL_FBK4        | 102P                                       |

## ispXPGA Logic Signal Connections: 900-Ball fpBGA (Cont.)

| 900 fpBGA Ball | LFX1200      |                 |                                            | LFX500       |                 |                                            |
|----------------|--------------|-----------------|--------------------------------------------|--------------|-----------------|--------------------------------------------|
|                | Signal Name  | Second Function | LVDS Pair/<br>sysHSI Reserved <sup>1</sup> | Signal Name  | Second Function | LVDS Pair/<br>sysHSI Reserved <sup>1</sup> |
| U27            | BK4_IO57     | PLL_FBK5        | 152N                                       | BK4_IO37     | PLL_FBK5        | 102N                                       |
| U29            | BK4_IO58     | SS_CLKOUT1P     | 153P                                       | BK4_IO38     | SS_CLKOUT1P     | 103P                                       |
| -              | GND (Bank 4) | --              | -                                          | -            | -               | -                                          |
| U30            | BK4_IO59     | SS_CLKOUT1N     | 153N                                       | BK4_IO39     | SS_CLKOUT1N     | 103N                                       |
| T30            | BK4_IO60     | CLK_OUT4        | 154P                                       | BK4_IO40     | CLK_OUT4        | 104P                                       |
| -              | -            | -               | -                                          | GND (Bank 4) | -               | -                                          |
| T29            | BK4_IO61     | CLK_OUT5        | 154N                                       | BK4_IO41     | CLK_OUT5        | 104N                                       |
| -              | GND (Bank 4) | -               | -                                          | -            | -               | -                                          |
| T28            | GCLK4        | -               | LVDS Pair2P                                | GCLK4        | -               | LVDS Pair2P                                |
| T27            | GCLK5        | -               | LVDS Pair2N                                | GCLK5        | -               | LVDS Pair2N                                |
| T26            | VCCP1        | -               | -                                          | VCCP1        | -               | -                                          |
| R28            | GNDP1        | -               | -                                          | GNDP1        | -               | -                                          |
| R27            | GCLK6        | -               | LVDS Pair3P                                | GCLK6        | -               | LVDS Pair3P                                |
| R26            | GCLK7        | -               | LVDS Pair3N                                | GCLK7        | -               | LVDS Pair3N                                |
| -              | GND (Bank 5) | -               | -                                          | -            | -               | -                                          |
| R29            | BK5_IO0      | CLK_OUT6        | 155P                                       | BK5_IO0      | CLK_OUT6        | 105P                                       |
| -              | -            | -               | -                                          | GND (Bank 5) | -               | -                                          |
| R30            | BK5_IO1      | CLK_OUT7        | 155N                                       | BK5_IO1      | CLK_OUT7        | 105N                                       |
| P30            | BK5_IO2      | PLL_FBK6        | 156P                                       | BK5_IO4      | PLL_FBK6        | 107P                                       |
| -              | GND (Bank 5) | -               | -                                          | GND (Bank 5) | -               | -                                          |
| P29            | BK5_IO3      | PLL_FBK7        | 156N                                       | BK5_IO7      | PLL_FBK7        | 108N                                       |
| P27            | BK5_IO4      | -               | 157P/HSI7                                  | BK5_IO2      | -               | 106P                                       |
| P28            | BK5_IO5      | -               | 157N/HSI7                                  | BK5_IO5      | -               | 107N                                       |
| P26            | BK5_IO6      | PLL_RST6        | 158P/HSI7                                  | BK5_IO6      | PLL_RST6        | 108P                                       |
| P25            | BK5_IO7      | PLL_RST7        | 158N/HSI7                                  | BK5_IO3      | PLL_RST7        | 106N                                       |
| N27            | BK5_IO8      | -               | 159P/HSI7                                  | BK5_IO8      | -               | 109P/HSI4                                  |
| N28            | BK5_IO9      | -               | 159N/HSI7                                  | BK5_IO9      | -               | 109N/HSI4                                  |
| N29            | BK5_IO10     | HSI7A_SINP      | 160P/HSI7                                  | BK5_IO10     | HSI4A_SINP      | 110P/HSI4                                  |
| -              | GND (Bank 5) | -               | -                                          | -            | -               | -                                          |
| N30            | BK5_IO11     | HSI7A_SINN      | 160N/HSI7                                  | BK5_IO11     | HSI4A_SINN      | 110N/HSI4                                  |
| N25            | BK5_IO12     | -               | 161P/HSI7                                  | BK5_IO12     | -               | 111P/HSI4                                  |
| N24            | BK5_IO13     | -               | 161N/HSI7                                  | BK5_IO13     | -               | 111N/HSI4                                  |
| M29            | BK5_IO14     | HSI7A_SOUTP     | 162P/HSI7                                  | BK5_IO14     | HSI4A_SOUTP     | 112P/HSI4                                  |
| -              | -            | -               | -                                          | GND (Bank 5) | -               | -                                          |
| M30            | BK5_IO15     | HSI7A_SOUTN     | 162N/HSI7                                  | BK5_IO15     | HSI4A_SOUTN     | 112N/HSI4                                  |
| M28            | BK5_IO16     | -               | 163P/HSI7                                  | BK5_IO16     | -               | 113P/HSI4                                  |
| M27            | BK5_IO17     | -               | 163N/HSI7                                  | BK5_IO17     | -               | 113N/HSI4                                  |
| L30            | BK5_IO18     | HSI7B_SINP      | 164P/HSI7                                  | BK5_IO18     | HSI4B_SINP      | 114P/HSI4                                  |
| -              | GND (Bank 5) | -               | -                                          | -            | -               | -                                          |
| L29            | BK5_IO19     | HSI7B_SINN      | 164N/HSI7                                  | BK5_IO19     | HSI4B_SINN      | 114N/HSI4                                  |
| M26            | BK5_IO20     | -               | 165P/HSI8                                  | BK5_IO20     | -               | 115P/HSI4                                  |
| M25            | BK5_IO21     | -               | 165N/HSI8                                  | BK5_IO21     | -               | 115N/HSI4                                  |

## ispXPGA Logic Signal Connections: 900-Ball fpBGA (Cont.)

| 900 fpBGA Ball | LFX1200      |                 |                                            | LFX500       |                 |                                            |
|----------------|--------------|-----------------|--------------------------------------------|--------------|-----------------|--------------------------------------------|
|                | Signal Name  | Second Function | LVDS Pair/<br>sysHSI Reserved <sup>1</sup> | Signal Name  | Second Function | LVDS Pair/<br>sysHSI Reserved <sup>1</sup> |
| K30            | BK5_IO22     | HSI7B_SOUTP     | 166P/HSI8                                  | BK5_IO22     | HSI4B_SOUTP     | 116P/HSI4                                  |
| -              | -            | -               | -                                          | GND (Bank 5) | -               | -                                          |
| K29            | BK5_IO23     | HSI7B_SOUTN     | 166N/HSI8                                  | BK5_IO23     | HSI4B_SOUTN     | 116N/HSI4                                  |
| L28            | BK5_IO24     | -               | 167P/HSI8                                  | BK5_IO24     | -               | 117P/HSI5                                  |
| L27            | BK5_IO25     | -               | 167N/HSI8                                  | BK5_IO25     | -               | 117N/HSI5                                  |
| L26            | BK5_IO26     | HSI8A_SINP      | 168P/HSI8                                  | BK5_IO26     | HSI5A_SINP      | 118P/HSI5                                  |
| -              | GND (Bank 5) | -               | -                                          | -            | -               | -                                          |
| L25            | BK5_IO27     | HSI8A_SINN      | 168N/HSI8                                  | BK5_IO27     | HSI5A_SINN      | 118N/HSI5                                  |
| K27            | BK5_IO28     | -               | 169P/HSI8                                  | BK5_IO28     | -               | 119P/HSI5                                  |
| K26            | BK5_IO29     | -               | 169N/HSI8                                  | BK5_IO29     | -               | 119N/HSI5                                  |
| J30            | BK5_IO30     | HSI8A_SOUTP     | 170P/HSI8                                  | BK5_IO30     | HSI5A_SOUTP     | 120P/HSI5                                  |
| -              | -            | -               | -                                          | GND (Bank 5) | -               | -                                          |
| J29            | BK5_IO31     | HSI8A_SOUTN     | 170N/HSI8                                  | BK5_IO31     | HSI5A_SOUTN     | 120N/HSI5                                  |
| J26            | BK5_IO32     | -               | 171P/HSI8                                  | NC           | -               | -                                          |
| J27            | BK5_IO33     | -               | 171N/HSI8                                  | NC           | -               | -                                          |
| H30            | BK5_IO34     | HSI8B_SINP      | 172P/HSI8                                  | NC           | -               | -                                          |
| -              | GND (Bank 5) | -               | -                                          | -            | -               | -                                          |
| H29            | BK5_IO35     | HSI8B_SINN      | 172N/HSI8                                  | NC           | -               | -                                          |
| J25            | BK5_IO36     | -               | 173P/HSI9                                  | NC           | -               | -                                          |
| J24            | BK5_IO37     | -               | 173N/HSI9                                  | NC           | -               | -                                          |
| G30            | BK5_IO38     | HSI8B_SOUTP     | 174P/HSI9                                  | NC           | -               | -                                          |
| G29            | BK5_IO39     | HSI8B_SOUTN     | 174N/HSI9                                  | NC           | -               | -                                          |
| H27            | BK5_IO40     | -               | 175P/HSI9                                  | NC           | -               | -                                          |
| H28            | BK5_IO41     | -               | 175N/HSI9                                  | NC           | -               | -                                          |
| F30            | BK5_IO42     | HSI9A_SINP      | 176P/HSI9                                  | NC           | -               | -                                          |
| -              | GND (Bank 5) | -               | -                                          | -            | -               | -                                          |
| F29            | BK5_IO43     | HSI9A_SINN      | 176N/HSI9                                  | NC           | -               | -                                          |
| G27            | BK5_IO44     | -               | 177P/HSI9                                  | NC           | -               | -                                          |
| G28            | BK5_IO45     | -               | 177N/HSI9                                  | NC           | -               | -                                          |
| E30            | BK5_IO46     | HSI9A_SOUTP     | 178P/HSI9                                  | NC           | -               | -                                          |
| E29            | BK5_IO47     | HSI9A_SOUTN     | 178N/HSI9                                  | NC           | -               | -                                          |
| H26            | BK5_IO48     | -               | 179P/HSI9                                  | BK5_IO33     | -               | 121N/HSI5                                  |
| H25            | BK5_IO49     | VREF5           | 179N/HSI9                                  | BK5_IO32     | VREF5           | 121P/HSI5                                  |
| D30            | BK5_IO50     | HSI9B_SINP      | 180P/HSI9                                  | BK5_IO34     | HSI5B_SINP      | 122P/HSI5                                  |
| -              | GND (Bank 5) | -               | -                                          | -            | -               | -                                          |
| D29            | BK5_IO51     | HSI9B_SINN      | 180N/HSI9                                  | BK5_IO35     | HSI5B_SINN      | 122N/HSI5                                  |
| F28            | BK5_IO52     | -               | 181P                                       | BK5_IO36     | -               | 123P/HSI5                                  |
| F27            | BK5_IO53     | -               | 181N                                       | BK5_IO37     | -               | 123N/HSI5                                  |
| C30            | BK5_IO54     | HSI9B_SOUTP     | 182P                                       | BK5_IO38     | HSI5B_SOUTP     | 124P/HSI5                                  |
| -              | -            | -               | -                                          | GND (Bank 5) | -               | -                                          |
| C29            | BK5_IO55     | HSI9B_SOUTN     | 182N                                       | BK5_IO39     | HSI5B_SOUTN     | 124N/HSI5                                  |
| G26            | BK5_IO56     | -               | 183P                                       | NC           | -               | -                                          |

## ispXPGA Logic Signal Connections: 900-Ball fpBGA (Cont.)

| 900 fpBGA Ball | LFX1200      |                 |                                            | LFX500       |                 |                                            |
|----------------|--------------|-----------------|--------------------------------------------|--------------|-----------------|--------------------------------------------|
|                | Signal Name  | Second Function | LVDS Pair/<br>sysHSI Reserved <sup>1</sup> | Signal Name  | Second Function | LVDS Pair/<br>sysHSI Reserved <sup>1</sup> |
| G25            | BK5_IO57     | -               | 183N                                       | NC           | -               | -                                          |
| F26            | BK5_IO58     | -               | 184P                                       | NC           | -               | -                                          |
| -              | GND (Bank 5) | -               | -                                          | -            | -               | -                                          |
| E28            | BK5_IO59     | -               | 184N                                       | NC           | -               | -                                          |
| E27            | BK5_IO60     | -               | 185P                                       | BK5_IO40     | -               | 125P                                       |
| D28            | BK5_IO61     | -               | 185N                                       | BK5_IO41     | -               | 125N                                       |
| C27            | CFG0         | -               | -                                          | CFG0         | -               | -                                          |
| B28            | DONE         | -               | -                                          | DONE         | -               | -                                          |
| A28            | PROGRAMb     | -               | -                                          | PROGRAMb     | -               | -                                          |
| D26            | BK6_IO0      | INITb           | 186P                                       | BK6_IO0      | INITb           | 126P                                       |
| C26            | BK6_IO1      | CCLK            | 186N                                       | BK6_IO1      | CCLK            | 126N                                       |
| B27            | BK6_IO2      | -               | 187P                                       | BK6_IO2      | -               | 127P                                       |
| -              | GND (Bank 6) | -               | -                                          | GND (Bank 6) | -               | -                                          |
| A27            | BK6_IO3      | -               | 187N                                       | BK6_IO3      | -               | 127N                                       |
| D25            | BK6_IO4      | CSb             | 188P                                       | BK6_IO4      | CSb             | 128P                                       |
| C25            | BK6_IO5      | Read            | 188N                                       | BK6_IO5      | READ            | 128N                                       |
| B26            | BK6_IO6      | -               | 189P                                       | BK6_IO6      | -               | 129P                                       |
| A26            | BK6_IO7      | -               | 189N                                       | BK6_IO7      | -               | 129N                                       |
| F24            | BK6_IO8      | -               | 190P                                       | BK6_IO8      | -               | 130P                                       |
| E24            | BK6_IO9      | -               | 190N                                       | BK6_IO9      | -               | 130N                                       |
| A25            | BK6_IO10     | -               | 191P                                       | BK6_IO10     | -               | 131P                                       |
| -              | GND (Bank 6) | -               | -                                          | GND (Bank 6) | -               | -                                          |
| B25            | BK6_IO11     | -               | 191N                                       | BK6_IO11     | -               | 131N                                       |
| D24            | BK6_IO12     | VREF6           | 192P                                       | BK6_IO21     | VREF6           | 136N                                       |
| C24            | BK6_IO13     | -               | 192N                                       | BK6_IO20     | -               | 136P                                       |
| A24            | BK6_IO14     | -               | 193P                                       | BK6_IO12     | -               | 132P                                       |
| B24            | BK6_IO15     | -               | 193N                                       | BK6_IO13     | -               | 132N                                       |
| F23            | BK6_IO16     | -               | 194P                                       | BK6_IO14     | -               | 133P                                       |
| E23            | BK6_IO17     | -               | 194N                                       | BK6_IO15     | -               | 133N                                       |
| A23            | BK6_IO18     | -               | 195P                                       | BK6_IO16     | -               | 134P                                       |
| -              | GND (Bank 6) | -               | -                                          | -            | -               | -                                          |
| B23            | BK6_IO19     | -               | 195N                                       | BK6_IO17     | -               | 134N                                       |
| C23            | BK6_IO20     | -               | 196P                                       | NC           | -               | -                                          |
| D23            | BK6_IO21     | -               | 196N                                       | NC           | -               | -                                          |
| E22            | BK6_IO22     | -               | 197P                                       | NC           | -               | -                                          |
| D22            | BK6_IO23     | -               | 197N                                       | NC           | -               | -                                          |
| G21            | BK6_IO24     | -               | 198P                                       | NC           | -               | -                                          |
| F21            | BK6_IO25     | -               | 198N                                       | NC           | -               | -                                          |
| B22            | BK6_IO26     | -               | 199P                                       | NC           | -               | -                                          |
| -              | GND (Bank 6) | -               | -                                          | -            | -               | -                                          |
| A22            | BK6_IO27     | -               | 199N                                       | NC           | -               | -                                          |
| E21            | BK6_IO28     | -               | 200P                                       | NC           | -               | -                                          |

## ispXPGA Logic Signal Connections: 900-Ball fpBGA (Cont.)

| 900 fpBGA Ball | LFX1200      |                 |                                            | LFX500       |                 |                                            |
|----------------|--------------|-----------------|--------------------------------------------|--------------|-----------------|--------------------------------------------|
|                | Signal Name  | Second Function | LVDS Pair/<br>sysHSI Reserved <sup>1</sup> | Signal Name  | Second Function | LVDS Pair/<br>sysHSI Reserved <sup>1</sup> |
| D21            | BK6_IO29     | -               | 200N                                       | NC           | -               | -                                          |
| A21            | BK6_IO30     | -               | 201P                                       | NC           | -               | -                                          |
| B21            | BK6_IO31     | -               | 201N                                       | NC           | -               | -                                          |
| F20            | BK6_IO32     | DATA7           | 202P                                       | BK6_IO18     | DATA7           | 135P                                       |
| -              | -            | -               | -                                          | GND (Bank 6) | -               | -                                          |
| E20            | BK6_IO33     | DATA6           | 202N                                       | BK6_IO19     | DATA6           | 135N                                       |
| D20            | BK6_IO34     | -               | 203P                                       | NC           | -               | -                                          |
| -              | GND (Bank 6) | -               | -                                          | -            | -               | -                                          |
| C20            | BK6_IO35     | -               | 203N                                       | NC           | -               | -                                          |
| F19            | BK6_IO36     | DATA5           | 204P                                       | BK6_IO22     | DATA5           | 137P                                       |
| E19            | BK6_IO37     | DATA4           | 204N                                       | BK6_IO23     | DATA4           | 137N                                       |
| B20            | BK6_IO38     | -               | 205P                                       | NC           | -               | -                                          |
| A20            | BK6_IO39     | -               | 205N                                       | NC           | -               | -                                          |
| D19            | BK6_IO40     | -               | 206P                                       | NC           | -               | -                                          |
| C19            | BK6_IO41     | -               | 206N                                       | NC           | -               | -                                          |
| A19            | BK6_IO42     | -               | 207P                                       | NC           | -               | -                                          |
| -              | GND (Bank 6) | -               | -                                          | -            | -               | -                                          |
| B19            | BK6_IO43     | -               | 207N                                       | NC           | -               | -                                          |
| G18            | BK6_IO44     | -               | 208P                                       | BK6_IO24     | -               | 138P                                       |
| F18            | BK6_IO45     | -               | 208N                                       | BK6_IO25     | -               | 138N                                       |
| A18            | BK6_IO46     | -               | 209P                                       | BK6_IO32     | -               | 142P                                       |
| B18            | BK6_IO47     | -               | 209N                                       | BK6_IO33     | -               | 142N                                       |
| D18            | BK6_IO48     | -               | 210P                                       | BK6_IO34     | -               | 143P                                       |
| -              | -            | -               | -                                          | GND (Bank 6) | -               | -                                          |
| C18            | BK6_IO49     | -               | 210N                                       | BK6_IO35     | -               | 143N                                       |
| F17            | BK6_IO50     | DATA3           | 211P                                       | BK6_IO26     | DATA3           | 139P                                       |
| -              | GND (Bank 6) | -               | -                                          | GND (Bank 6) | -               | -                                          |
| E17            | BK6_IO51     | DATA2           | 211N                                       | BK6_IO27     | DATA2           | 139N                                       |
| D17            | BK6_IO52     | -               | 212P                                       | BK6_IO28     | -               | 140P                                       |
| C17            | BK6_IO53     | -               | 212N                                       | BK6_IO29     | -               | 140N                                       |
| B17            | BK6_IO54     | DATA1           | 213P                                       | BK6_IO30     | DATA1           | 141P                                       |
| A17            | BK6_IO55     | DATA0           | 213N                                       | BK6_IO31     | DATA0           | 141N                                       |
| F16            | BK6_IO56     | -               | 214P                                       | BK6_IO36     | -               | 144P                                       |
| E16            | BK6_IO57     | -               | 214N                                       | BK6_IO37     | -               | 144N                                       |
| D16            | BK6_IO58     | -               | 215P                                       | BK6_IO38     | -               | 145P                                       |
| -              | GND (Bank 6) | -               | -                                          | -            | -               | -                                          |
| C16            | BK6_IO59     | -               | 215N                                       | BK6_IO39     | -               | 145N                                       |
| B16            | BK6_IO60     | -               | 216P                                       | BK6_IO40     | -               | 146P                                       |
| A16            | BK6_IO61     | -               | 216N                                       | BK6_IO41     | -               | 146N                                       |
| -              | GND (Bank 6) | -               | -                                          | GND (Bank 6) | -               | -                                          |
| -              | GND (Bank 7) | -               | -                                          | GND (Bank 7) | -               | -                                          |
| A15            | BK7_IO0      | -               | 217P                                       | BK7_IO0      | -               | 147P                                       |

**ispXPGA Logic Signal Connections: 900-Ball fpBGA (Cont.)**

| 900 fpBGA Ball | LFX1200      |                 |                                         | LFX500       |                 |                                         |
|----------------|--------------|-----------------|-----------------------------------------|--------------|-----------------|-----------------------------------------|
|                | Signal Name  | Second Function | LVDS Pair/ sysHSI Reserved <sup>1</sup> | Signal Name  | Second Function | LVDS Pair/ sysHSI Reserved <sup>1</sup> |
| B15            | BK7_IO1      | -               | 217N                                    | BK7_IO1      | -               | 147N                                    |
| C15            | BK7_IO2      | -               | 218P                                    | BK7_IO2      | -               | 148P                                    |
| -              | GND (Bank 7) | -               | -                                       | -            | -               | -                                       |
| D15            | BK7_IO3      | -               | 218N                                    | BK7_IO3      | -               | 148N                                    |
| E15            | BK7_IO4      | -               | 219P                                    | BK7_IO4      | -               | 149P                                    |
| F15            | BK7_IO5      | -               | 219N                                    | BK7_IO5      | -               | 149N                                    |
| A14            | BK7_IO6      | -               | 220P                                    | BK7_IO6      | -               | 150P                                    |
| -              | -            | -               | -                                       | GND (Bank 7) | -               | -                                       |
| B14            | BK7_IO7      | -               | 220N                                    | BK7_IO7      | -               | 150N                                    |
| C14            | BK7_IO8      | -               | 221P                                    | BK7_IO8      | -               | 151P                                    |
| D14            | BK7_IO9      | -               | 221N                                    | BK7_IO9      | -               | 151N                                    |
| E14            | BK7_IO10     | -               | 222P                                    | BK7_IO10     | -               | 152P                                    |
| -              | GND (Bank 7) | -               | -                                       | -            | -               | -                                       |
| F14            | BK7_IO11     | -               | 222N                                    | BK7_IO11     | -               | 152N                                    |
| C13            | BK7_IO12     | -               | 223P                                    | BK7_IO12     | -               | 153P                                    |
| D13            | BK7_IO13     | -               | 223N                                    | BK7_IO13     | -               | 153N                                    |
| B13            | BK7_IO14     | -               | 224P                                    | BK7_IO14     | -               | 154P                                    |
| -              | -            | -               | -                                       | GND (Bank 7) | -               | -                                       |
| A13            | BK7_IO15     | -               | 224N                                    | BK7_IO15     | -               | 154N                                    |
| F13            | BK7_IO16     | -               | 225P                                    | BK7_IO16     | -               | 155P                                    |
| G13            | BK7_IO17     | -               | 225N                                    | BK7_IO17     | -               | 155N                                    |
| A12            | BK7_IO18     | -               | 226P                                    | BK7_IO18     | -               | 156P                                    |
| -              | GND (Bank 7) | -               | -                                       | -            | -               | -                                       |
| B12            | BK7_IO19     | -               | 226N                                    | BK7_IO19     | -               | 156N                                    |
| C12            | BK7_IO20     | -               | 227P                                    | NC           | -               | -                                       |
| D12            | BK7_IO21     | -               | 227N                                    | NC           | -               | -                                       |
| A11            | BK7_IO22     | -               | 228P                                    | NC           | -               | -                                       |
| B11            | BK7_IO23     | -               | 228N                                    | NC           | -               | -                                       |
| E12            | BK7_IO24     | -               | 229P                                    | NC           | -               | -                                       |
| F12            | BK7_IO25     | -               | 229N                                    | NC           | -               | -                                       |
| C11            | BK7_IO26     | -               | 230P                                    | NC           | -               | -                                       |
| -              | GND (Bank 7) | -               | -                                       | -            | -               | -                                       |
| D11            | BK7_IO27     | -               | 230N                                    | NC           | -               | -                                       |
| E11            | BK7_IO28     | -               | 231P                                    | NC           | -               | -                                       |
| F11            | BK7_IO29     | -               | 231N                                    | NC           | -               | -                                       |
| B10            | BK7_IO30     | -               | 232P                                    | NC           | -               | -                                       |
| A10            | BK7_IO31     | -               | 232N                                    | NC           | -               | -                                       |
| D10            | BK7_IO32     | -               | 233P                                    | NC           | -               | -                                       |
| E10            | BK7_IO33     | -               | 233N                                    | NC           | -               | -                                       |
| A9             | BK7_IO34     | -               | 234P                                    | NC           | -               | -                                       |
| -              | GND (Bank 7) | -               | -                                       | -            | -               | -                                       |
| B9             | BK7_IO35     | -               | 234N                                    | NC           | -               | -                                       |

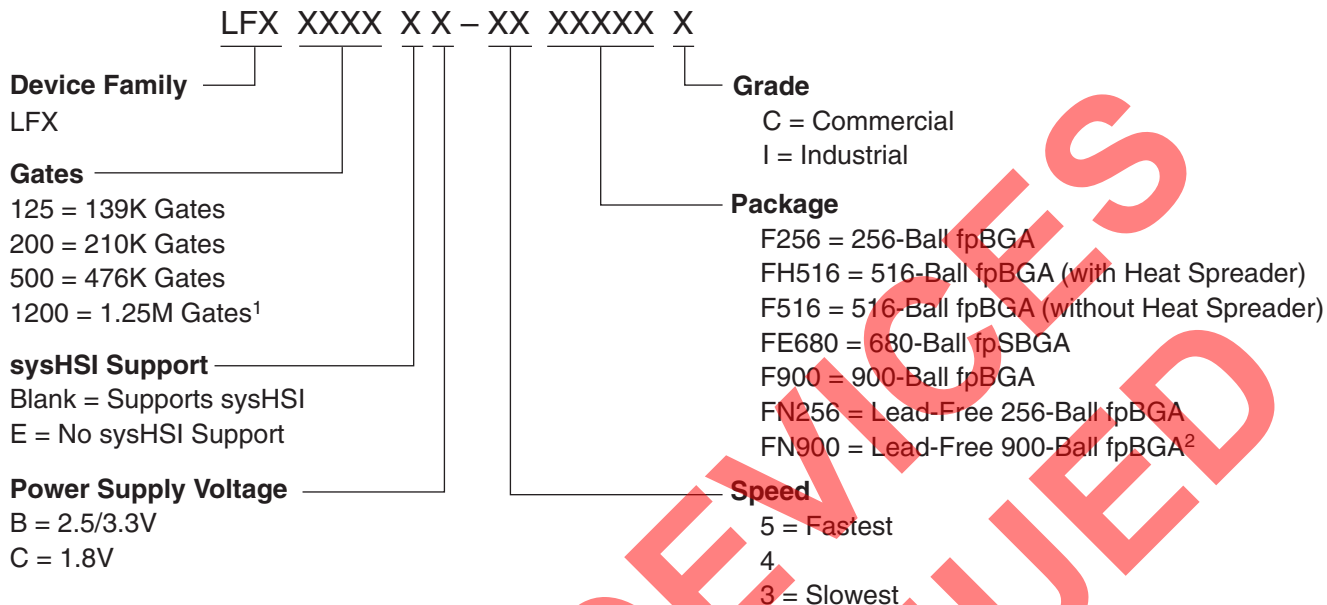
ispXPGA Logic Signal Connections: 900-Ball fpBGA (Cont.)

| 900 fpBGA Ball | LFX1200      |                 |                                         | LFX500       |                 |                                         |
|----------------|--------------|-----------------|-----------------------------------------|--------------|-----------------|-----------------------------------------|
|                | Signal Name  | Second Function | LVDS Pair/ sysHSI Reserved <sup>1</sup> | Signal Name  | Second Function | LVDS Pair/ sysHSI Reserved <sup>1</sup> |
| F10            | BK7_IO36     | -               | 235P                                    | NC           | -               | -                                       |
| G10            | BK7_IO37     | -               | 235N                                    | NC           | -               | -                                       |
| A8             | BK7_IO38     | -               | 236P                                    | NC           | -               | -                                       |
| B8             | BK7_IO39     | -               | 236N                                    | NC           | -               | -                                       |
| D9             | BK7_IO40     | -               | 237P                                    | BK7_IO22     | -               | 158P                                    |
| -              | -            | -               | -                                       | GND (Bank 7) | -               | -                                       |
| E9             | BK7_IO41     | -               | 237N                                    | BK7_IO23     | -               | 158N                                    |
| A7             | BK7_IO42     | -               | 238P                                    | BK7_IO24     | -               | 159P                                    |
| -              | GND (Bank 7) | -               | -                                       | -            | -               | -                                       |
| B7             | BK7_IO43     | -               | 238N                                    | BK7_IO25     | -               | 159N                                    |
| C8             | BK7_IO44     | -               | 239P                                    | BK7_IO26     | -               | 160P                                    |
| D8             | BK7_IO45     | -               | 239N                                    | BK7_IO27     | -               | 160N                                    |
| A6             | BK7_IO46     | -               | 240P                                    | BK7_IO21     | -               | 157N                                    |
| B6             | BK7_IO47     | VREF7           | 240N                                    | BK7_IO20     | VREF7           | 157P                                    |
| E8             | BK7_IO48     | -               | 241P                                    | BK7_IO28     | -               | 161P                                    |
| F8             | BK7_IO49     | -               | 241N                                    | BK7_IO29     | -               | 161N                                    |
| C7             | BK7_IO50     | -               | 242P                                    | BK7_IO30     | -               | 162P                                    |
| -              | GND (Bank 7) | -               | -                                       | GND (Bank 7) | -               | -                                       |
| D7             | BK7_IO51     | -               | 242N                                    | BK7_IO31     | -               | 162N                                    |
| E7             | BK7_IO52     | -               | 243P                                    | BK7_IO32     | -               | 163P                                    |
| F7             | BK7_IO53     | -               | 243N                                    | BK7_IO33     | -               | 163N                                    |
| A5             | BK7_IO54     | -               | 244P                                    | BK7_IO34     | -               | 164P                                    |
| B5             | BK7_IO55     | -               | 244N                                    | BK7_IO35     | -               | 164N                                    |
| C6             | BK7_IO56     | -               | 245P                                    | BK7_IO36     | -               | 165P                                    |
| D6             | BK7_IO57     | -               | 245N                                    | BK7_IO37     | -               | 165N                                    |
| D5             | BK7_IO58     | -               | 246P                                    | BK7_IO38     | -               | 166P                                    |
| -              | GND (Bank 7) | -               | -                                       | GND (Bank 7) | -               | -                                       |
| C5             | BK7_IO59     | -               | 246N                                    | BK7_IO39     | -               | 166N                                    |
| B4             | BK7_IO60     | -               | 247P                                    | BK7_IO40     | -               | 167P                                    |
| A4             | BK7_IO61     | -               | 247N                                    | BK7_IO41     | -               | 167N                                    |
| A3             | TDO          | -               | -                                       | TDO          | -               | -                                       |
| B3             | VCCJ         | -               | -                                       | VCCJ         | -               | -                                       |
| C4             | TDI          | -               | -                                       | TDI          | -               | -                                       |

1. If a sysHSI Block is used, the indicated sysHSI reserved pins are unavailable for general purpose I/O use.



### Part Number Description



1. Discontinued via PCN #03A-10.  
 2. Select products only. See Ordering Information tables below for specific support.

### Ordering Information Conventional Packaging

**Commercial**

| Part Number                   | Gates | Voltage | Speed Grade | Package | Balls |
|-------------------------------|-------|---------|-------------|---------|-------|
| LFX125B-05F256C               | 139K  | 2.5/3.3 | -5          | fpBGA   | 256   |
| LFX125B-04F256C               | 139K  | 2.5/3.3 | -4          | fpBGA   | 256   |
| LFX125B-03F256C               | 139K  | 2.5/3.3 | -3          | fpBGA   | 256   |
| LFX125C-04F256C               | 139K  | 1.8     | -4          | fpBGA   | 256   |
| LFX125C-03F256C               | 139K  | 1.8     | -3          | fpBGA   | 256   |
| LFX125B-05F516C               | 139K  | 2.5/3.3 | -5          | fpBGA   | 516   |
| LFX125B-04F516C               | 139K  | 2.5/3.3 | -4          | fpBGA   | 516   |
| LFX125B-03F516C               | 139K  | 2.5/3.3 | -3          | fpBGA   | 516   |
| LFX125C-04F516C               | 139K  | 1.8     | -4          | fpBGA   | 516   |
| LFX125C-03F516C               | 139K  | 1.8     | -3          | fpBGA   | 516   |
| LFX125B-05FH516C <sup>1</sup> | 139K  | 2.5/3.3 | -5          | fpBGA   | 516   |
| LFX125B-04FH516C <sup>1</sup> | 139K  | 2.5/3.3 | -4          | fpBGA   | 516   |
| LFX125B-03FH516C <sup>1</sup> | 139K  | 2.5/3.3 | -3          | fpBGA   | 516   |
| LFX125C-04FH516C <sup>1</sup> | 139K  | 1.8     | -4          | fpBGA   | 516   |
| LFX125C-03FH516C <sup>1</sup> | 139K  | 1.8     | -3          | fpBGA   | 516   |
| LFX200B-05F256C               | 210K  | 2.5/3.3 | -5          | fpBGA   | 256   |
| LFX200B-04F256C               | 210K  | 2.5/3.3 | -4          | fpBGA   | 256   |
| LFX200B-03F256C               | 210K  | 2.5/3.3 | -3          | fpBGA   | 256   |
| LFX200C-04F256C               | 210K  | 1.8     | -4          | fpBGA   | 256   |
| LFX200C-03F256C               | 210K  | 1.8     | -3          | fpBGA   | 256   |

## Commercial (Cont.)

| Part Number                    | Gates | Voltage | Speed Grade | Package | Balls |
|--------------------------------|-------|---------|-------------|---------|-------|
| LFX200B-05F516C                | 210K  | 2.5/3.3 | -5          | fpBGA   | 516   |
| LFX200B-04F516C                | 210K  | 2.5/3.3 | -4          | fpBGA   | 516   |
| LFX200B-03F516C                | 210K  | 2.5/3.3 | -3          | fpBGA   | 516   |
| LFX200C-04F516C                | 210K  | 1.8     | -4          | fpBGA   | 516   |
| LFX200C-03F516C                | 210K  | 1.8     | -3          | fpBGA   | 516   |
| LFX200B-05FH516C <sup>1</sup>  | 210K  | 2.5/3.3 | -5          | fpBGA   | 516   |
| LFX200B-04FH516C <sup>1</sup>  | 210K  | 2.5/3.3 | -4          | fpBGA   | 516   |
| LFX200B-03FH516C <sup>1</sup>  | 210K  | 2.5/3.3 | -3          | fpBGA   | 516   |
| LFX200C-04FH516C <sup>1</sup>  | 210K  | 1.8     | -4          | fpBGA   | 516   |
| LFX200C-03FH516C <sup>1</sup>  | 210K  | 1.8     | -3          | fpBGA   | 516   |
| LFX500B-05F516C                | 476K  | 2.5/3.3 | -5          | fpBGA   | 516   |
| LFX500B-04F516C                | 476K  | 2.5/3.3 | -4          | fpBGA   | 516   |
| LFX500B-03F516C                | 476K  | 2.5/3.3 | -3          | fpBGA   | 516   |
| LFX500C-04F516C                | 476K  | 1.8     | -4          | fpBGA   | 516   |
| LFX500C-03F516C                | 476K  | 1.8     | -3          | fpBGA   | 516   |
| LFX500B-05FH516C <sup>1</sup>  | 476K  | 2.5/3.3 | -5          | fpBGA   | 516   |
| LFX500B-04FH516C <sup>1</sup>  | 476K  | 2.5/3.3 | -4          | fpBGA   | 516   |
| LFX500B-03FH516C <sup>1</sup>  | 476K  | 2.5/3.3 | -3          | fpBGA   | 516   |
| LFX500C-04FH516C <sup>1</sup>  | 476K  | 1.8     | -4          | fpBGA   | 516   |
| LFX500C-03FH516C <sup>1</sup>  | 476K  | 1.8     | -3          | fpBGA   | 516   |
| LFX500B-05F900C                | 476K  | 2.5/3.3 | -5          | fpBGA   | 900   |
| LFX500B-04F900C                | 476K  | 2.5/3.3 | -4          | fpBGA   | 900   |
| LFX500B-03F900C                | 476K  | 2.5/3.3 | -3          | fpBGA   | 900   |
| LFX500C-04F900C                | 476K  | 1.8     | -4          | fpBGA   | 900   |
| LFX500C-03F900C                | 476K  | 1.8     | -3          | fpBGA   | 900   |
| LFX1200B-05F900C <sup>2</sup>  | 1.25M | 2.5/3.3 | -5          | fpBGA   | 900   |
| LFX1200B-04F900C <sup>2</sup>  | 1.25M | 2.5/3.3 | -4          | fpBGA   | 900   |
| LFX1200B-03F900C <sup>2</sup>  | 1.25M | 2.5/3.3 | -3          | fpBGA   | 900   |
| LFX1200C-04F900C <sup>2</sup>  | 1.25M | 1.8     | -4          | fpBGA   | 900   |
| LFX1200C-03F900C <sup>2</sup>  | 1.25M | 1.8     | -3          | fpBGA   | 900   |
| LFX1200B-05FE680C <sup>2</sup> | 1.25M | 2.5/3.3 | -5          | fpSBGA  | 680   |
| LFX1200B-04FE680C <sup>2</sup> | 1.25M | 2.5/3.3 | -4          | fpSBGA  | 680   |
| LFX1200B-03FE680C <sup>2</sup> | 1.25M | 2.5/3.3 | -3          | fpSBGA  | 680   |
| LFX1200C-04FE680C <sup>2</sup> | 1.25M | 1.8     | -4          | fpSBGA  | 680   |
| LFX1200C-03FE680C <sup>2</sup> | 1.25M | 1.8     | -3          | fpSBGA  | 680   |

1. FH516 package was converted to F516 via [PCN #09A-08](#).

2. Discontinued via [PCN #03A-10](#).

## "E-Series" Commercial

| Part Number                    | Gates | Voltage | Speed Grade | Package | Balls |
|--------------------------------|-------|---------|-------------|---------|-------|
| LFX125EB-05F256C               | 139K  | 2.5/3.3 | -5          | fpBGA   | 256   |
| LFX125EB-04F256C               | 139K  | 2.5/3.3 | -4          | fpBGA   | 256   |
| LFX125EB-03F256C               | 139K  | 2.5/3.3 | -3          | fpBGA   | 256   |
| LFX125EC-04F256C               | 139K  | 1.8     | -4          | fpBGA   | 256   |
| LFX125EC-03F256C               | 139K  | 1.8     | -3          | fpBGA   | 256   |
| LFX125EB-05F516C               | 139K  | 2.5/3.3 | -5          | fpBGA   | 516   |
| LFX125EB-04F516C               | 139K  | 2.5/3.3 | -4          | fpBGA   | 516   |
| LFX125EB-03F516C               | 139K  | 2.5/3.3 | -3          | fpBGA   | 516   |
| LFX125EC-04F516C               | 139K  | 1.8     | -4          | fpBGA   | 516   |
| LFX125EC-03F516C               | 139K  | 1.8     | -3          | fpBGA   | 516   |
| LFX125EB-05FH516C <sup>1</sup> | 139K  | 2.5/3.3 | -5          | fpBGA   | 516   |
| LFX125EB-04FH516C <sup>1</sup> | 139K  | 2.5/3.3 | -4          | fpBGA   | 516   |
| LFX125EB-03FH516C <sup>1</sup> | 139K  | 2.5/3.3 | -3          | fpBGA   | 516   |
| LFX125EC-04FH516C <sup>1</sup> | 139K  | 1.8     | -4          | fpBGA   | 516   |
| LFX125EC-03FH516C <sup>1</sup> | 139K  | 1.8     | -3          | fpBGA   | 516   |
| LFX200EB-05F256C               | 210K  | 2.5/3.3 | -5          | fpBGA   | 256   |
| LFX200EB-04F256C               | 210K  | 2.5/3.3 | -4          | fpBGA   | 256   |
| LFX200EB-03F256C               | 210K  | 2.5/3.3 | -3          | fpBGA   | 256   |
| LFX200EC-04F256C               | 210K  | 1.8     | -4          | fpBGA   | 256   |
| LFX200EC-03F256C               | 210K  | 1.8     | -3          | fpBGA   | 256   |
| LFX200EB-05F516C               | 210K  | 2.5/3.3 | -5          | fpBGA   | 516   |
| LFX200EB-04F516C               | 210K  | 2.5/3.3 | -4          | fpBGA   | 516   |
| LFX200EB-03F516C               | 210K  | 2.5/3.3 | -3          | fpBGA   | 516   |
| LFX200EC-04F516C               | 210K  | 1.8     | -4          | fpBGA   | 516   |
| LFX200EC-03F516C               | 210K  | 1.8     | -3          | fpBGA   | 516   |
| LFX200EB-05FH516C <sup>1</sup> | 210K  | 2.5/3.3 | -5          | fpBGA   | 516   |
| LFX200EB-04FH516C <sup>1</sup> | 210K  | 2.5/3.3 | -4          | fpBGA   | 516   |
| LFX200EB-03FH516C <sup>1</sup> | 210K  | 2.5/3.3 | -3          | fpBGA   | 516   |
| LFX200EC-04FH516C <sup>1</sup> | 210K  | 1.8     | -4          | fpBGA   | 516   |
| LFX200EC-03FH516C <sup>1</sup> | 210K  | 1.8     | -3          | fpBGA   | 516   |
| LFX500EB-05F516C               | 476K  | 2.5/3.3 | -5          | fpBGA   | 516   |
| LFX500EB-04F516C               | 476K  | 2.5/3.3 | -4          | fpBGA   | 516   |
| LFX500EB-03F516C               | 476K  | 2.5/3.3 | -3          | fpBGA   | 516   |
| LFX500EC-04F516C               | 476K  | 1.8     | -4          | fpBGA   | 516   |
| LFX500EC-03F516C               | 476K  | 1.8     | -3          | fpBGA   | 516   |
| LFX500EB-05FH516C <sup>1</sup> | 476K  | 2.5/3.3 | -5          | fpBGA   | 516   |
| LFX500EB-04FH516C <sup>1</sup> | 476K  | 2.5/3.3 | -4          | fpBGA   | 516   |
| LFX500EB-03FH516C <sup>1</sup> | 476K  | 2.5/3.3 | -3          | fpBGA   | 516   |
| LFX500EC-04FH516C <sup>1</sup> | 476K  | 1.8     | -4          | fpBGA   | 516   |
| LFX500EC-03FH516C <sup>1</sup> | 476K  | 1.8     | -3          | fpBGA   | 516   |
| LFX500EB-05F900C               | 476K  | 2.5/3.3 | -5          | fpBGA   | 900   |
| LFX500EB-04F900C               | 476K  | 2.5/3.3 | -4          | fpBGA   | 900   |
| LFX500EB-03F900C               | 476K  | 2.5/3.3 | -3          | fpBGA   | 900   |
| LFX500EC-04F900C               | 476K  | 1.8     | -4          | fpBGA   | 900   |

## "E-Series" Commercial (Cont.)

| Part Number                     | Gates | Voltage | Speed Grade | Package | Balls |
|---------------------------------|-------|---------|-------------|---------|-------|
| LFX500EC-03F900C                | 476K  | 1.8     | -3          | fpBGA   | 900   |
| LFX1200EB-05F900C <sup>2</sup>  | 1.25M | 2.5/3.3 | -5          | fpBGA   | 900   |
| LFX1200EB-04F900C <sup>2</sup>  | 1.25M | 2.5/3.3 | -4          | fpBGA   | 900   |
| LFX1200EB-03F900C <sup>2</sup>  | 1.25M | 2.5/3.3 | -3          | fpBGA   | 900   |
| LFX1200EC-04F900C <sup>2</sup>  | 1.25M | 1.8     | -4          | fpBGA   | 900   |
| LFX1200EC-03F900C <sup>2</sup>  | 1.25M | 1.8     | -3          | fpBGA   | 900   |
| LFX1200EB-05FE680C <sup>2</sup> | 1.25M | 2.5/3.3 | -5          | fpSBGA  | 680   |
| LFX1200EB-04FE680C <sup>2</sup> | 1.25M | 2.5/3.3 | -4          | fpSBGA  | 680   |
| LFX1200EB-03FE680C <sup>2</sup> | 1.25M | 2.5/3.3 | -3          | fpSBGA  | 680   |
| LFX1200EC-04FE680C <sup>2</sup> | 1.25M | 1.8     | -4          | fpSBGA  | 680   |
| LFX1200EC-03FE680C <sup>2</sup> | 1.25M | 1.8     | -3          | fpSBGA  | 680   |

1. FH516 package was converted to F516 via [PCN #09A-08](#).

2. Discontinued via [PCN #03A-10](#).

## "E-Series" Industrial

| Part Number                    | Gates | Voltage | Speed Grade | Package | Balls |
|--------------------------------|-------|---------|-------------|---------|-------|
| LFX125EB-04F256I               | 139K  | 2.5/3.3 | -4          | fpBGA   | 256   |
| LFX125EB-03F256I               | 139K  | 2.5/3.3 | -3          | fpBGA   | 256   |
| LFX125EC-03F256I               | 139K  | 1.8     | -3          | fpBGA   | 256   |
| LFX125EB-04F516I               | 139K  | 2.5/3.3 | -4          | fpBGA   | 516   |
| LFX125EB-03F516I               | 139K  | 2.5/3.3 | -3          | fpBGA   | 516   |
| LFX125EC-03F516I               | 139K  | 1.8     | -3          | fpBGA   | 516   |
| LFX125EB-04FH516I <sup>1</sup> | 139K  | 2.5/3.3 | -4          | fpBGA   | 516   |
| LFX125EB-03FH516I <sup>1</sup> | 139K  | 2.5/3.3 | -3          | fpBGA   | 516   |
| LFX125EC-03FH516I <sup>1</sup> | 139K  | 1.8     | -3          | fpBGA   | 516   |
| LFX200EB-04F256I               | 210K  | 2.5/3.3 | -4          | fpBGA   | 256   |
| LFX200EB-03F256I               | 210K  | 2.5/3.3 | -3          | fpBGA   | 256   |
| LFX200EC-03F256I               | 210K  | 1.8     | -3          | fpBGA   | 256   |
| LFX200EB-04F516I               | 210K  | 2.5/3.3 | -4          | fpBGA   | 516   |
| LFX200EB-03F516I               | 210K  | 2.5/3.3 | -3          | fpBGA   | 516   |
| LFX200EC-03F516I               | 210K  | 1.8     | -3          | fpBGA   | 516   |
| LFX200EB-04FH516I <sup>1</sup> | 210K  | 2.5/3.3 | -4          | fpBGA   | 516   |
| LFX200EB-03FH516I <sup>1</sup> | 210K  | 2.5/3.3 | -3          | fpBGA   | 516   |
| LFX200EC-03FH516I <sup>1</sup> | 210K  | 1.8     | -3          | fpBGA   | 516   |
| LFX500EB-04F516I               | 476K  | 2.5/3.3 | -4          | fpBGA   | 516   |
| LFX500EB-03F516I               | 476K  | 2.5/3.3 | -3          | fpBGA   | 516   |
| LFX500EC-03F516I               | 476K  | 1.8     | -3          | fpBGA   | 516   |
| LFX500EB-04FH516I <sup>1</sup> | 476K  | 2.5/3.3 | -4          | fpBGA   | 516   |
| LFX500EB-03FH516I <sup>1</sup> | 476K  | 2.5/3.3 | -3          | fpBGA   | 516   |
| LFX500EC-03FH516I <sup>1</sup> | 476K  | 1.8     | -3          | fpBGA   | 516   |
| LFX500EB-04F900I               | 476K  | 2.5/3.3 | -4          | fpBGA   | 900   |
| LFX500EB-03F900I               | 476K  | 2.5/3.3 | -3          | fpBGA   | 900   |
| LFX500EC-03F900I               | 476K  | 1.8     | -3          | fpBGA   | 900   |

## "E-Series" Industrial (Cont.)

| Part Number                     | Gates | Voltage | Speed Grade | Package | Balls |
|---------------------------------|-------|---------|-------------|---------|-------|
| LFX1200EB-04F900I <sup>2</sup>  | 1.25M | 2.5/3.3 | -4          | fpBGA   | 900   |
| LFX1200EB-03F900I <sup>2</sup>  | 1.25M | 2.5/3.3 | -3          | fpBGA   | 900   |
| LFX1200EC-03F900I <sup>2</sup>  | 1.25M | 1.8     | -3          | fpBGA   | 900   |
| LFX1200EB-04FE680I <sup>2</sup> | 1.25M | 2.5/3.3 | -4          | fpSBGA  | 680   |
| LFX1200EB-03FE680I <sup>2</sup> | 1.25M | 2.5/3.3 | -3          | fpSBGA  | 680   |
| LFX1200EC-03FE680I <sup>2</sup> | 1.25M | 1.8     | -3          | fpSBGA  | 680   |

1. FH516 package was converted to F516 via [PCN #09A-08](#).

2. Discontinued via [PCN #03A-10](#).

## Lead-Free Packaging

## Commercial

| Part Number      | Gates | Voltage | Speed Grade | Package         | Balls |
|------------------|-------|---------|-------------|-----------------|-------|
| LFX125B-05FN256C | 139K  | 2.5/3.3 | -5          | Lead-Free fpBGA | 256   |
| LFX125B-04FN256C | 139K  | 2.5/3.3 | -4          | Lead-Free fpBGA | 256   |
| LFX125B-03FN256C | 139K  | 2.5/3.3 | -3          | Lead-Free fpBGA | 256   |
| LFX125C-04FN256C | 139K  | 1.8     | -4          | Lead-Free fpBGA | 256   |
| LFX125C-03FN256C | 139K  | 1.8     | -3          | Lead-Free fpBGA | 256   |
| LFX200B-05FN256C | 210K  | 2.5/3.3 | -5          | Lead-Free fpBGA | 256   |
| LFX200B-04FN256C | 210K  | 2.5/3.3 | -4          | Lead-Free fpBGA | 256   |
| LFX200B-03FN256C | 210K  | 2.5/3.3 | -3          | Lead-Free fpBGA | 256   |
| LFX200C-04FN256C | 210K  | 1.8     | -4          | Lead-Free fpBGA | 256   |
| LFX200C-03FN256C | 210K  | 1.8     | -3          | Lead-Free fpBGA | 256   |
| LFX500B-05FN900C | 476K  | 2.5/3.3 | -5          | Lead-Free fpBGA | 900   |
| LFX500B-04FN900C | 476K  | 2.5/3.3 | -4          | Lead-Free fpBGA | 900   |
| LFX500B-03FN900C | 476K  | 2.5/3.3 | -3          | Lead-Free fpBGA | 900   |
| LFX500C-04FN900C | 476K  | 1.8     | -4          | Lead-Free fpBGA | 900   |
| LFX500C-03FN900C | 476K  | 1.8     | -3          | Lead-Free fpBGA | 900   |

## "E-Series" Commercial

| Part Number       | Gates | Voltage | Speed Grade | Package         | Balls |
|-------------------|-------|---------|-------------|-----------------|-------|
| LFX125EB-05FN256C | 139K  | 2.5/3.3 | -5          | Lead-Free fpBGA | 256   |
| LFX125EB-04FN256C | 139K  | 2.5/3.3 | -4          | Lead-Free fpBGA | 256   |
| LFX125EB-03FN256C | 139K  | 2.5/3.3 | -3          | Lead-Free fpBGA | 256   |
| LFX125EC-04FN256C | 139K  | 1.8     | -4          | Lead-Free fpBGA | 256   |
| LFX125EC-03FN256C | 139K  | 1.8     | -3          | Lead-Free fpBGA | 256   |
| LFX200EB-05FN256C | 210K  | 2.5/3.3 | -5          | Lead-Free fpBGA | 256   |
| LFX200EB-04FN256C | 210K  | 2.5/3.3 | -4          | Lead-Free fpBGA | 256   |
| LFX200EB-03FN256C | 210K  | 2.5/3.3 | -3          | Lead-Free fpBGA | 256   |
| LFX200EC-04FN256C | 210K  | 1.8     | -4          | Lead-Free fpBGA | 256   |
| LFX200EC-03FN256C | 210K  | 1.8     | -3          | Lead-Free fpBGA | 256   |
| LFX500EB-05FN900C | 476K  | 2.5/3.3 | -5          | Lead-Free fpBGA | 900   |
| LFX500EB-04FN900C | 476K  | 2.5/3.3 | -4          | Lead-Free fpBGA | 900   |
| LFX500EB-03FN900C | 476K  | 2.5/3.3 | -3          | Lead-Free fpBGA | 900   |

## “E-Series” Commercial (Cont.)

| Part Number       | Gates | Voltage | Speed Grade | Package         | Balls |
|-------------------|-------|---------|-------------|-----------------|-------|
| LFX500EC-04FN900C | 476K  | 1.8     | -4          | Lead-Free fpBGA | 900   |
| LFX500EC-03FN900C | 476K  | 1.8     | -3          | Lead-Free fpBGA | 900   |

## “E-Series” Industrial

| Part Number       | Gates | Voltage | Speed Grade | Package         | Balls |
|-------------------|-------|---------|-------------|-----------------|-------|
| LFX125EB-04FN256I | 139K  | 2.5/3.3 | -4          | Lead-Free fpBGA | 256   |
| LFX125EB-03FN256I | 139K  | 2.5/3.3 | -3          | Lead-Free fpBGA | 256   |
| LFX125EC-03FN256I | 139K  | 1.8     | -3          | Lead-Free fpBGA | 256   |
| LFX200EB-04FN256I | 210K  | 2.5/3.3 | -4          | Lead-Free fpBGA | 256   |
| LFX200EB-03FN256I | 210K  | 2.5/3.3 | -3          | Lead-Free fpBGA | 256   |
| LFX200EC-03FN256I | 210K  | 1.8     | -3          | Lead-Free fpBGA | 256   |
| LFX500EB-04FN900I | 476K  | 2.5/3.3 | -4          | Lead-Free fpBGA | 900   |
| LFX500EB-03FN900I | 476K  | 2.5/3.3 | -3          | Lead-Free fpBGA | 900   |
| LFX500EC-03FN900I | 476K  | 1.8     | -3          | Lead-Free fpBGA | 900   |

## For Further Information

In addition to this data sheet, the following Lattice technical notes may be helpful when designing with the ispXPGA Family:

- TN1028, [ispXPGA Memory Usage Guidelines](#)
- TN1003, [sysCLOCK PLL Usage and Design Guidelines](#)
- TN1000, [sysIO Usage Guidelines for Lattice Devices](#)
- TN1026, [ispXP Configuration Usage Guidelines](#)
- TN1020, [sysHSI Usage Guidelines](#)
- TN1043, [Power Estimation in ispXPGA Devices](#)

## Revision History

| Date           | Version | Change Summary                                                                                                                |
|----------------|---------|-------------------------------------------------------------------------------------------------------------------------------|
| —              | —       | Previous Lattice releases.                                                                                                    |
| September 2003 | 07      | Improved typical Icc data for LFX125B/C and LFX500B/C.                                                                        |
|                |         | Improved external switching characteristics timing numbers for LFX125B/C.                                                     |
|                |         | Improved PIC timing numbers for LFX125B/C.                                                                                    |
|                |         | Improved t <sub>IOINDLY</sub> timing numbers for LFX125B/C.                                                                   |
|                |         | Improved external switching characteristics timing numbers for LFX500B/C.                                                     |
|                |         | Improved PIC timing numbers for LFX500B/C.                                                                                    |
|                |         | Improved t <sub>IOINDLY</sub> timing numbers for LFX500B/C.                                                                   |
|                |         | Enhanced CDR functionality description.                                                                                       |
| January 2004   | 07.1    | Added lead-free package designators.                                                                                          |
|                |         | Updated CDR specifications and reference notes. Removed Source Synchronous (SS:No CAL) mode references for the sysHSI blocks. |
|                |         | Revised Figures 16 and 24 for clarification.                                                                                  |
|                |         | Clarification of VCC sysHSI Block for 1.8V devices.                                                                           |
|                |         | Updated IIL and IIH max specification.                                                                                        |
| June 2004      | 08.0    | Updated LVTTL and PCI 3.3 to support 5V tolerance.                                                                            |

**Revision History (Cont.)**

| Date                 | Version         | Change Summary                                                                                                                                                                  |
|----------------------|-----------------|---------------------------------------------------------------------------------------------------------------------------------------------------------------------------------|
| June 2004<br>(cont.) | 08.0<br>(cont.) | Updated Global Clock Input Setup time specifications.                                                                                                                           |
|                      |                 | Clarification of Serial Out LVDS test condition.                                                                                                                                |
|                      |                 | Clarification of REFCLK, SS_CLKIN peak-to-peak period jitter condition.                                                                                                         |
|                      |                 | Added sysHSI Reserved pins and footnote.                                                                                                                                        |
|                      |                 | Removed industrial ordering part numbers.                                                                                                                                       |
| July 2004            | 09.0            | Added "E" Series product family.                                                                                                                                                |
| August 2004          | 10.0            | Final release.                                                                                                                                                                  |
| December 2004        | 10.1            | Updated NC Connections table.                                                                                                                                                   |
| April 2005           | 10.2            | Clarification of IDK specification.                                                                                                                                             |
| April 2005           | 11.0            | Select lead-free packages release.                                                                                                                                              |
| July 2005            | 12.0            | Added lead-free 516 fpBGA ordering part numbers.                                                                                                                                |
| April 2007           | 13.0            | Removed lead-free 680 fpSBGA information from Part Number Description and Ordering Part Number tables. Removed lead-free 516 fpBGA for LFX125 from Ordering Part Number tables. |
| November 2007        | 14.0            | Removed lead-free 516 fpBGA information from Part Number Description and Ordering Part Number tables.                                                                           |
| July 2008            | 14.1            | Added 516 fpBGA package without heat spreader to Part Number Description and Ordering Part Number tables.                                                                       |
| February 2010        | 15.0            | Ordering part numbers and ispXPGA Family Selection Guide table have been updated per PCN #03A-10 (discontinuation of the ispXPGA 1200 devices).                                 |
|                      |                 | References to "system gates" changed to "functional gates."                                                                                                                     |

SELECTED DEVICES DISCONTINUED