

Micropower, Regulated Charge Pump in 2 × 2 DFN

FEATURES

- **Ultralow Power: 8µA Quiescent Current**
- Regulated Output Voltages: 3.3V ±4%, 5V ±4%, ADJ
- V_{IN} Range:
 - 1.8V to 4.4V (LTC3221-3.3)
 - 2.7V to 5.5V (LTC3221-5)
- Output Current: Up to 60mA
- No Inductors Needed
- Very Low Shutdown Current: <1µA
- Shutdown Disconnects Load from V_{IN}
- Burst Mode Control
- Short-Circuit Protected
- Solution Profile < 1mm
- Tiny 2mm × 2mm 6-Pin DFN Package

APPLICATIONS

- Low Power 2 AA Cell to 3.3V Supply
- Memory Backup Supplies
- Tire Pressure Sensors
- General Purpose Low Power Li-Ion to 5V Supply
- RF Transmitters
- Glucose Meters

DESCRIPTION

The LTC[®]3221 family are micropower charge pump DC/DC converters that produce a regulated output at up to 60mA. The input voltage range is 1.8V to 5.5V. Extremely low operating current (8µA typical at no load) and low external parts count (one flying capacitor and two small bypass capacitors at V_{IN} and V_{OUT}) make them ideally suited for small, battery-powered applications.

The LTC3221 family includes fixed 5V and 3.3V output versions plus an adjustable version. All parts operate as Burst Mode[®] switched capacitor voltage doublers to achieve ultralow quiescent current. The chips use a controlled current to supply the output and will survive a continuous short-circuit from V_{OUT} to GND. The FB pin of the adjustable LTC3221 can be used to program the desired output voltage.

The LTC3221 family is available in a low profile (0.75mm) 2mm × 2mm 6-pin DFN package.

LT, LT, LTC and LTM are registered trademarks of Linear Technology Corporation. Burst Mode is a registered trademark of Linear Technology Corporation. All other trademarks are the property of their respective owners.

TYPICAL APPLICATION

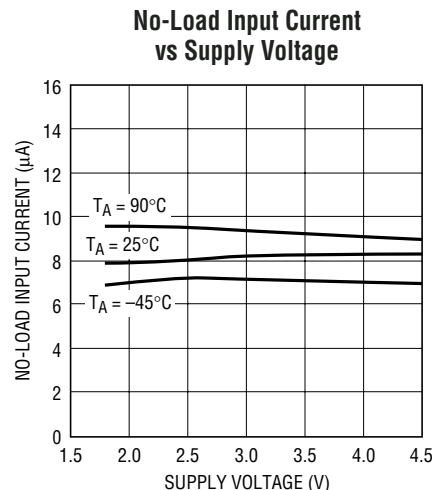
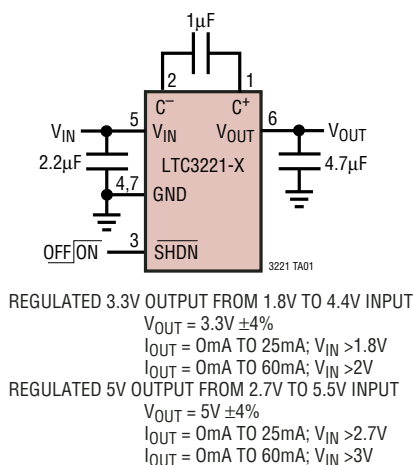

3221 TA01b

LTC3221/ LTC3221-3.3/LTC3221-5

ABSOLUTE MAXIMUM RATINGS

(Note 1)

V_{IN} , SHDN, FB	-0.3V to 6V
V_{OUT} to GND.....	-0.3V to 5.5V
V_{OUT} Short-Circuit Duration	Indefinite
Operating Temperature Range (Note 2) ..	-40°C to 85°C
Storage Temperature Range.....	-65°C to 125°C
Maximum Junction Temperature	125°C

PACKAGE/ORDER INFORMATION

TOP VIEW

DC PACKAGE
6-LEAD (2mm x 2mm) PLASTIC DFN
 $T_{JMAX} = 125^{\circ}C$, $\theta_{JA} = 80^{\circ}C/W$
EXPOSED PAD IS GND (PIN 7) MUST BE SOLDERED TO PCB
*SHDN ON LTC3221-3.3; LTC3221-5 FB ON LTC3221

ORDER PART NUMBER	DC PART MARKING
LTC3221EDC	LCCP
LTC3221EDC-3.3	LBQP
LTC3221EDC-5	LCCN

Order Options Tape and Reel: Add #TR
Lead Free: Add #PBF Lead Free Tape and Reel: Add #TRPBF
Lead Free Part Marking: <http://www.linear.com/leadfree/>

Consult LTC Marketing for parts specified with wider operating temperature ranges.

ELECTRICAL CHARACTERISTICS

The ● denotes the specifications which apply over the full operating temperature range, otherwise specifications are at $T_A = 25^{\circ}C$. $V_{IN} = 2.5V$ (LTC3221-3.3/LTC3221) or $3V$ (LTC3221-5), $SHDN = V_{IN}$, $C_{FLY} = 1\mu F$, $C_{IN} = 2.2\mu F$, $C_{OUT} = 2.2\mu F$, unless otherwise specified.

SYMBOL	PARAMETER	CONDITIONS	MIN	TYP	MAX	UNITS
LTC3221-3.3						
V_{IN}	Input Supply Voltage		● 1.8		4.4	V
V_{OUT}	Output Voltage	$1.8V \leq V_{IN} \leq 4.4V$, $I_{OUT} \leq 25mA$ $2V \leq V_{IN} < 4.4V$, $I_{OUT} \leq 60mA$	● 3.168	3.3	3.432	V
I_{CC}	Operating Supply Current	$I_{OUT} = 0mA$	●	8	15	μA
V_R	Output Ripple	$V_{IN} = 2V$, $I_{OUT} = 60mA$, $C_{OUT} = 4.7\mu F$ (Note 3)		35		mV _{P-P}
η	Efficiency	$V_{IN} = 2V$, $I_{OUT} = 60mA$ (Note 3)		82		%
I_{SC}	Output Short-Circuit Current	$V_{OUT} = 0V$	●	120	240	mA
LTC3221-5						
V_{IN}	Input Supply Voltage		● 2.7		5.5	V
V_{OUT}	Output Voltage	$2.7V \leq V_{IN} \leq 5.5V$, $I_{OUT} < 25mA$ $3V \leq V_{IN} \leq 5.5V$, $I_{OUT} < 60mA$	● 4.8	5	5.2	V
I_{CC}	Operating Supply Current	$I_{OUT} = 0mA$	●	8	15	μA
V_R	Output Ripple	$V_{IN} = 3V$, $I_{OUT} = 60mA$, $C_{OUT} = 4.7\mu F$ (Note 3)		45		mV _{P-P}
η	Efficiency	$V_{IN} = 3V$, $I_{OUT} = 60mA$ (Note 3)		82		%
I_{SC}	Output Short-Circuit Current	$V_{OUT} = 0V$	●	120	240	mA
LTC3221						
V_{IN}	Input Supply Voltage		● 1.8		5.5	V
V_{FB}	Feedback Voltage		● 1.181	1.23	1.279	V
R_{OL}	Open-Loop Impedance	$V_{IN} = 1.8V$, $V_{OUT} = 3V$ (Note 4)	●	10	20	Ω
I_{CC}	Operating Supply Current	$I_{OUT} = 0mA$	●	5	12	μA
I_{FB}	FB Input Current	$FB = 1.33V$, $V_{IN} = 2V$	●	-100	100	nA

3221f

ELECTRICAL CHARACTERISTICS The ● denotes the specifications which apply over the full operating temperature range, otherwise specifications are at $T_A = 25^\circ\text{C}$. $V_{IN} = 2.5\text{V}$ (LTC3221-3.3/LTC3221) or 3V (LTC3221-5), $\overline{\text{SHDN}} = V_{IN}$, $C_{FLY} = 1\mu\text{F}$, $C_{IN} = 2.2\mu\text{F}$, $C_{OUT} = 2.2\mu\text{F}$, unless otherwise specified.

SYMBOL	PARAMETER	CONDITIONS	MIN	TYP	MAX	UNITS
LTC3221-3.3/LTC3221-5						
$I_{\overline{\text{SHDN}}}$	Shutdown Supply Current	$V_{OUT} = 0\text{V}$, $\overline{\text{SHDN}} = 0\text{V}$	●		1	μA
V_{IH}	$\overline{\text{SHDN}}$ Input Threshold (High)		●	1.3		V
V_{IL}	$\overline{\text{SHDN}}$ Input Threshold (Low)		●		0.4	V
I_{IH}	$\overline{\text{SHDN}}$ Input Current (High)	$\overline{\text{SHDN}} = V_{IN}$	●	-1	1	μA
I_{IL}	$\overline{\text{SHDN}}$ Input Current (Low)	$\overline{\text{SHDN}} = 0\text{V}$	●	-1	1	μA
LTC3221/LTC3221-3.3/LTC3221-5						
f_{OSC}	Switching Frequency	$V_{OUT} = 2.5\text{V}$		600		kHz
V_{UVLO}	UVLO Threshold			1		V

Note 1: Absolute Maximum Ratings are those values beyond which the life of a device may be impaired.

Note 2: The LTC3221EDC-X is guaranteed to meet performance specifications from 0°C to 70°C . Specification over the -40°C to 85°C

operating temperature range are assured by design, characterization and correlation with statistical process controls.

Note 3: Guaranteed by design, not subject to test.

Note 4: $R_{OL} = (2V_{IN} - V_{OUT})/I_{OUT}$.

TYPICAL PERFORMANCE CHARACTERISTICS

Oscillator Frequency vs Supply Voltage

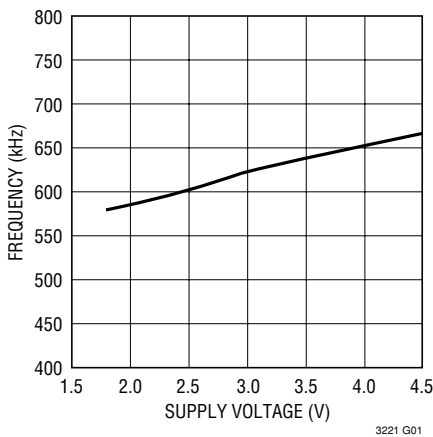

Oscillator Frequency vs Temperature

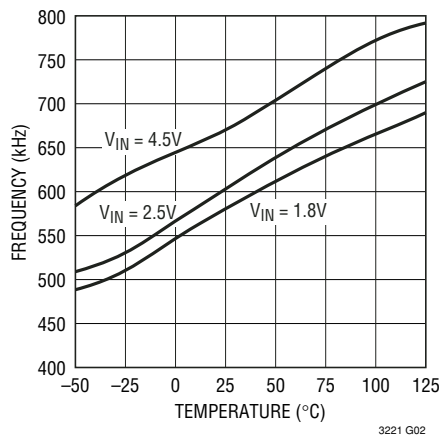

$\overline{\text{SHDN}}$ Threshold Voltage vs Supply Voltage

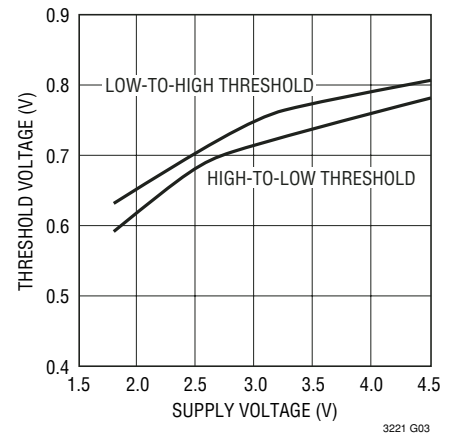

$\overline{\text{SHDN}}$ LO-to-HI Threshold vs Temperature

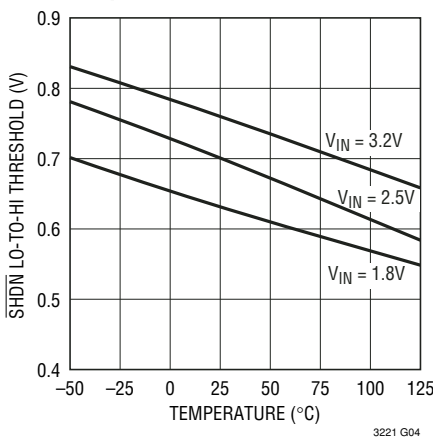

$\overline{\text{SHDN}}$ HI-to-LO Threshold vs Temperature

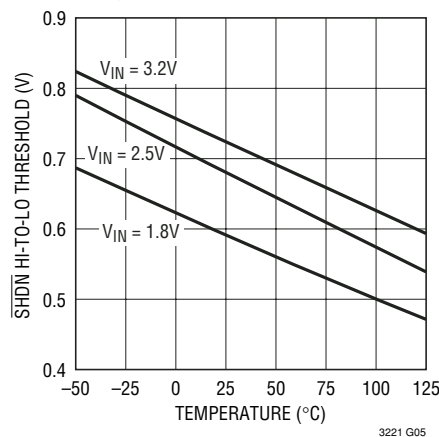

Short-Circuit Current vs Supply Voltage

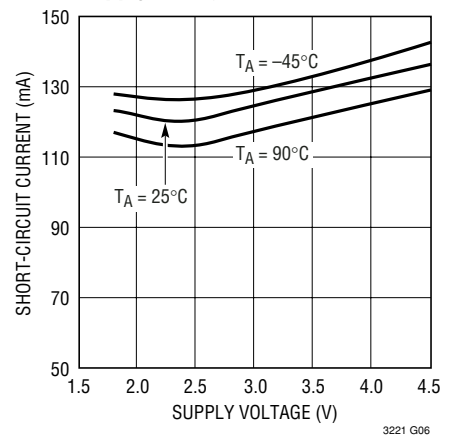

TYPICAL PERFORMANCE CHARACTERISTICS (LTC3221-3.3 only)

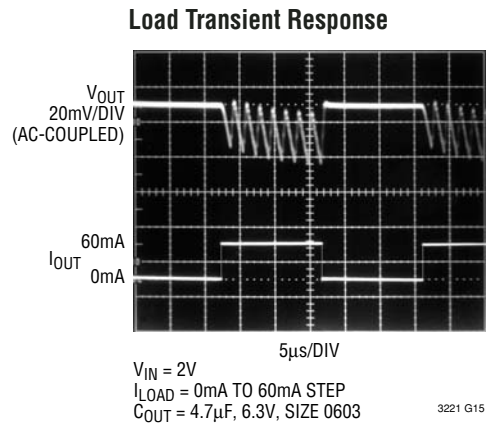
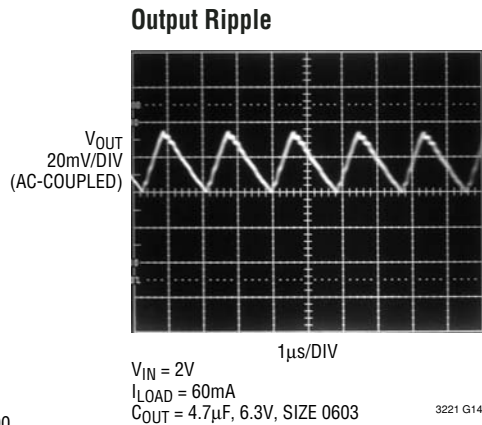
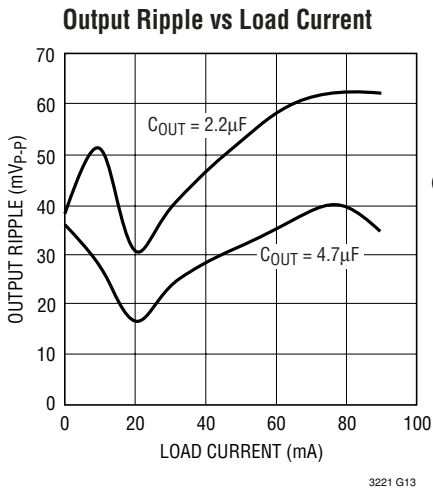
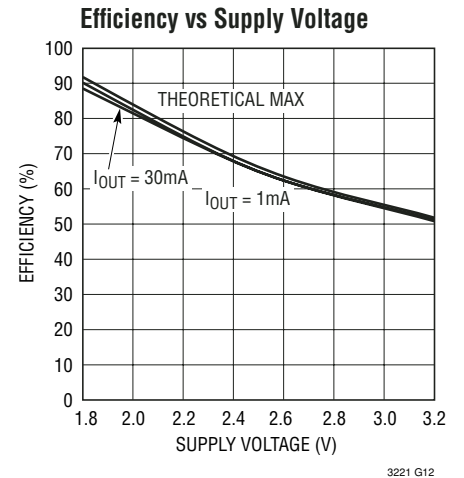
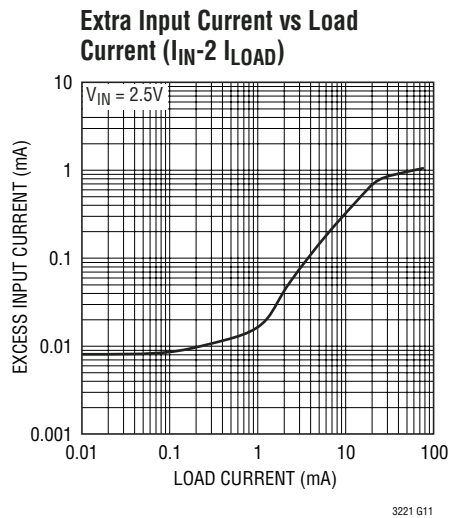
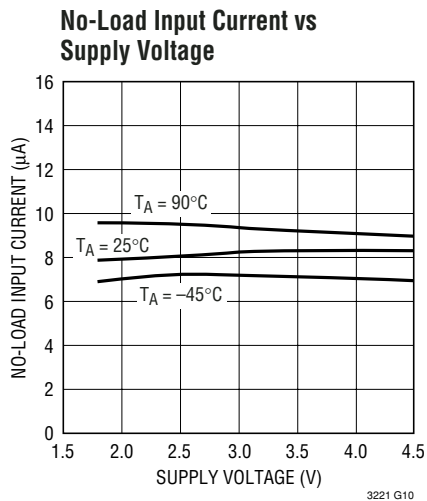
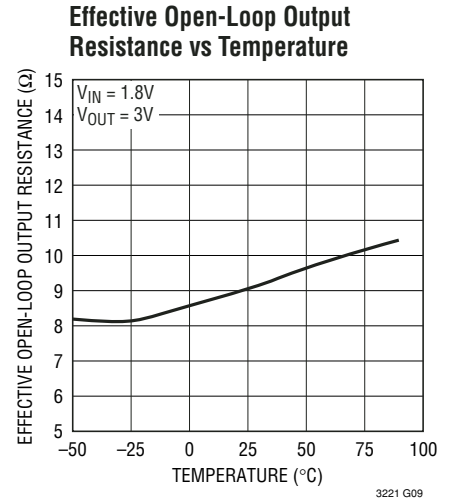
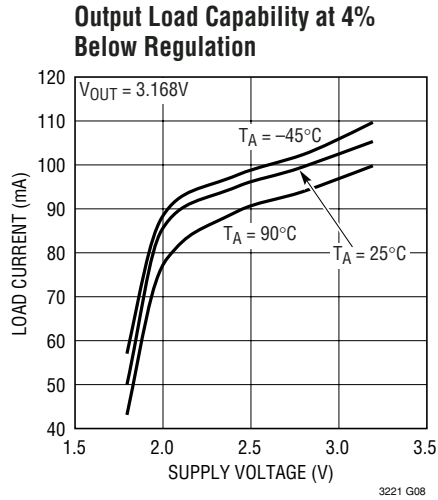
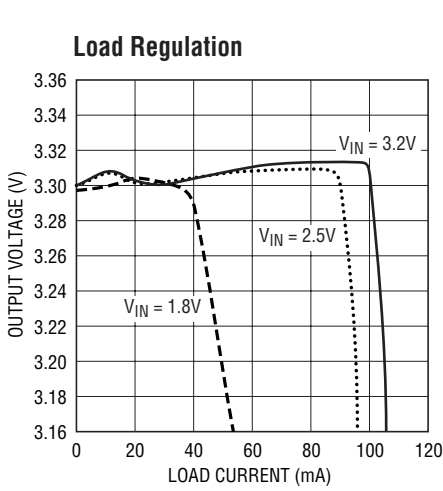

TYPICAL PERFORMANCE CHARACTERISTICS (LTC3221-5 only)

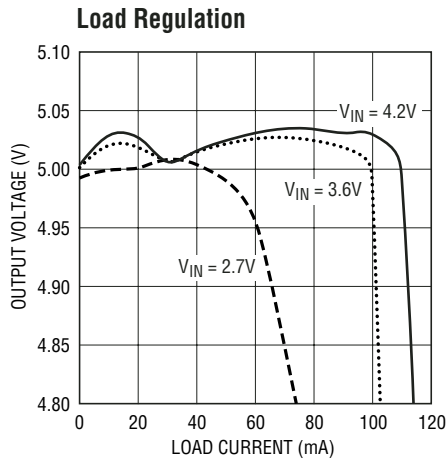

3221 G16

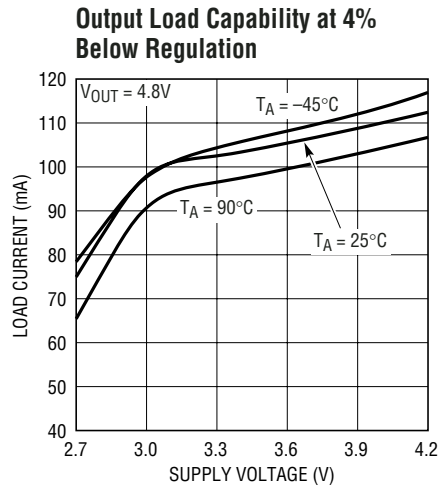

3221 G17

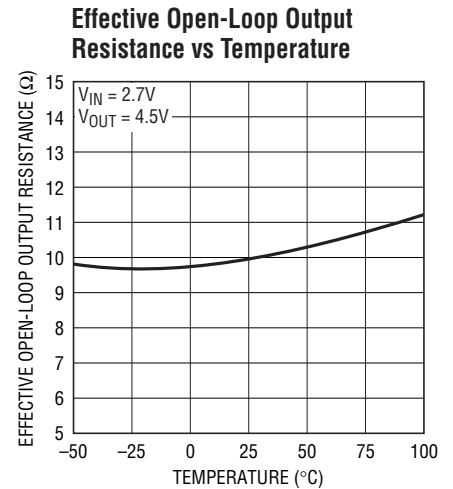

3221 G18

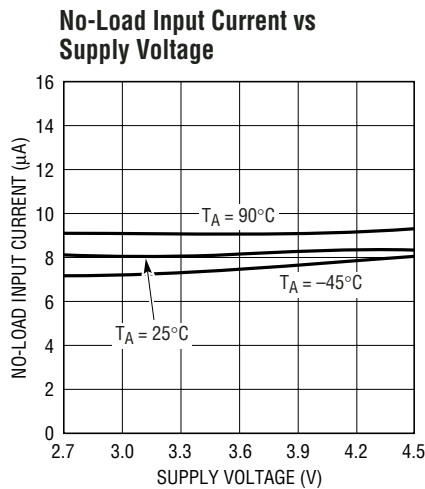

3221 G19

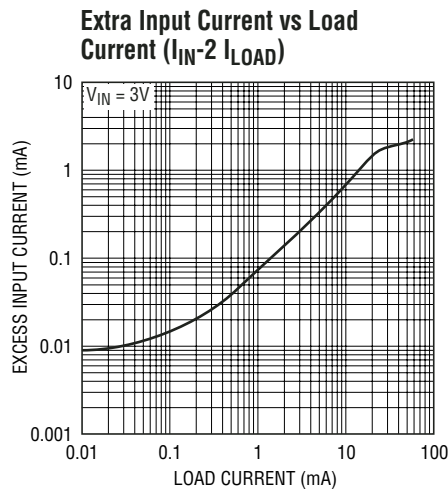

3221 G20

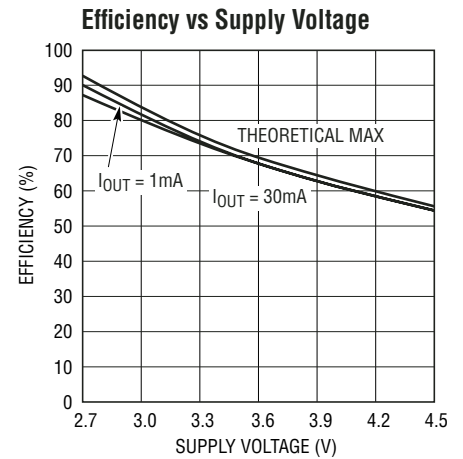

3221 G21

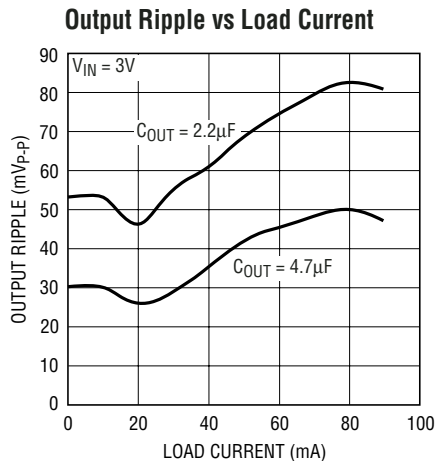

3221 G13

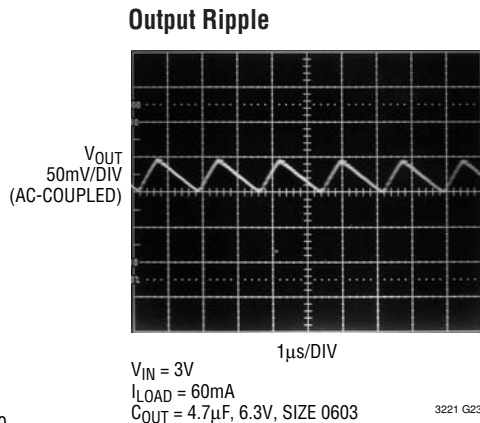

3221 G23

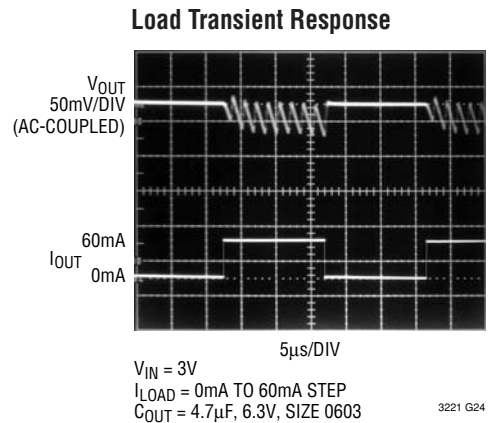

3221 G24

PIN FUNCTIONS

C+ (Pin 1): Flying Capacitor Positive Terminal.

C- (Pin 2): Flying Capacitor Negative Terminal.

$\overline{\text{SHDN}}$ (Pin 3) (LTC3221-3.3/LTC3221-5): Active Low Shutdown Input. A low on $\overline{\text{SHDN}}$ disables the LTC3221-3.3/LTC3221-5. $\overline{\text{SHDN}}$ must not be allowed to float.

FB (Pin 3) (LTC3221): Feedback. The voltage on this pin is compared to the internal reference voltage (1.23V) by the error comparator to keep the output in regulation. An external resistor divider is required between V_{OUT} and FB to program the output voltage.

GND (Pin 4): Ground. Should be tied to a ground plane for best performance.

V_{IN} (Pin 5): Input Supply Voltage. V_{IN} should be bypassed with a 2.2 μF low ESR capacitor.

V_{OUT} (Pin 6): Regulated Output Voltage. For best performance, V_{OUT} should be bypassed with a 2.2 μF or higher low ESR capacitor as close as possible to the pin.

Exposed Pad (Pin 7) Ground. The exposed pad must be soldered to PCB ground to provide electrical contact and optimum thermal performance.

BLOCK DIAGRAM

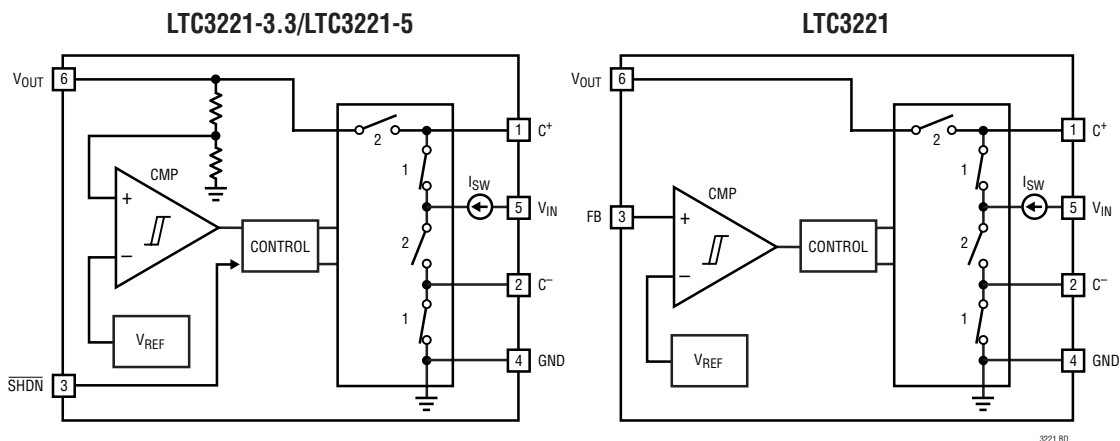

OPERATION (Refer to Block Diagrams)

The LTC3221 family uses a switched capacitor charge pump to boost V_{IN} to a regulated output voltage. Regulation is achieved by monitoring the output voltage, V_{OUT} using a comparator (CMP in the Block Diagram) and keeping it within a hysteresis window. If V_{OUT} drops below the lower trip point of CMP, V_{OUT} is charged by the controlled current, I_{SW} in series with the flying capacitor C_{FLY} . Once V_{OUT} goes above the upper trip point of CMP, or if the upper trip point is not reached after 0.8 μs , C_{FLY} is disconnected from V_{OUT} . The bottom plate of C_{FLY} is then connected to GND to allow I_{SW} to replenish the charge on C_{FLY} for 0.8 μs . After which, I_{SW} is turned off to keep the operating supply current low. CMP continues to monitor V_{OUT} and turns on I_{SW} if the lower threshold is reached again.

Shutdown Mode

The $\overline{\text{SHDN}}$ pin is a CMOS input with a threshold voltage of approximately 0.8V. The LTC3221-3.3/ LTC3221-5 are in shutdown when a logic low is applied to the $\overline{\text{SHDN}}$ pin. In shutdown mode, all circuitry is turned off and the LTC3221-3.3/ LTC3221-5 draw only leakage current from the V_{IN} supply. Furthermore, V_{OUT} is disconnected from V_{IN} . Since the $\overline{\text{SHDN}}$ pin is a very high impedance CMOS input, it should never be allowed to float.

When $\overline{\text{SHDN}}$ is asserted low, the charge pump is first disabled, but the LTC3221-3.3/LTC3221-5 continue to draw 5 μA of supply current. This current will drop to zero when the output voltage (V_{OUT}) is fully discharged to 0V.

OPERATION (Refer to Block Diagrams)

The LTC3221 has a FB pin in place of the $\overline{\text{SHDN}}$ pin. This allows the output voltage to be programmed using an external resistive divider.

Burst Mode Operation

The LTC3221 family regulates the output voltage throughout the full 60mA load range using Burst Mode control. This keeps the quiescent current low at light load and improves the efficiency at full load by reducing the switching losses. All the internal circuitry except the comparator is kept off if the output voltage is high and the flying capacitor has been fully charged. These circuits are turned on only if V_{OUT} drops below the comparator lower threshold. At light load,

V_{OUT} stays above this lower threshold for a long period of time, this result in a very low average input current.

Soft-Start and Short-Circuit Protection

The LTC3221 family uses a controlled current, I_{SW} to deliver current to the output. This helps to limit the input and output current during start-up and output short-circuit condition. During start up I_{SW} is used to charge up the flying capacitor and output capacitor, this limits the input current to approximately 240mA. During short-circuit condition, the output current is delivered through I_{SW} and this limits the output current to approximately 120mA. This prevents excessive self-heating that causes damage to the part.

APPLICATIONS INFORMATION

Power Efficiency

The input current of a doubling charge pump like the LTC3221 family is always twice that of the output current. This is true regardless of whether the output voltage is unregulated or regulated or of the regulation method used. In an ideal unregulated doubling charge pump, conservation of energy implies that the input current has to be twice that of the output current in order to obtain an output voltage twice that of the input voltage. In a regulated charge pump like the LTC3221, the regulation of V_{OUT} is similar to that of a linear regulator, with the voltage difference between $2 \cdot V_{\text{IN}}$ (Input voltage plus the voltage across a fully charged flying capacitor) and V_{OUT} being absorbed in an internal pass transistor. In the LTC3221, the controlled current I_{SW} acts as a pass transistor. So the input current of an ideal regulated doubling charge pump is the same as an unregulated one, which is equal to twice the output current. The efficiency (η) of an ideal regulated doubler is therefore given by:

$$\eta = \frac{P_{\text{OUT}}}{P_{\text{IN}}} = \frac{V_{\text{OUT}} \cdot I_{\text{OUT}}}{V_{\text{IN}} \cdot 2I_{\text{OUT}}} = \frac{V_{\text{OUT}}}{2V_{\text{IN}}}$$

At moderate to high output power, the switching losses and quiescent current of the LTC3221 family are negligible and the expression is valid. For example, an LTC3221-5 with $V_{\text{IN}} = 3\text{V}$, $I_{\text{OUT}} = 60\text{mA}$ and V_{OUT} regulating to 5V, has a measured efficiency of 82% which is in close agreement with

the theoretical 83.3% calculation. The LTC3221 product family continues to maintain good efficiency even at fairly light loads because of its inherently low power design.

Maximum Available Output Current

For the adjustable LTC3221, the maximum available output current and voltage can be calculated from the effective open-loop output resistance, R_{OL} , and effective output voltage, $2V_{\text{IN(MIN)}}$.

From Figure 1 the available current is given by:

$$I_{\text{OUT}} = \frac{2V_{\text{IN}} - V_{\text{OUT}}}{R_{\text{OL}}}$$

Effective Open-Loop Output Resistance (R_{OL})

The effective open-loop output resistance (R_{OL}) of a charge pump is a very important parameter which determines the strength of the charge pump. The value of this parameter

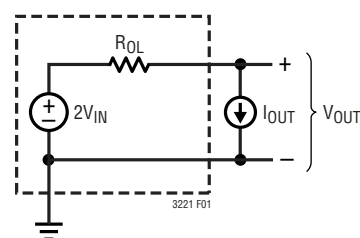

Figure 1. Equivalent Open-Loop Circuit

APPLICATIONS INFORMATION

depends on many factors such as the oscillator frequency (f_{OSC}), value of the flying capacitor (C_{FLY}), the nonoverlap time, the internal switch resistances (R_S) and the ESR of the external capacitors. A first order approximation for R_{OL} is given below:

$$R_{OL} \cong 2 \sum_{S=1TO4} R_S + \frac{1}{f_{OSC} \cdot C_{FLY}}$$

Typical R_{OL} values as a function of temperature are shown in Figure 2.

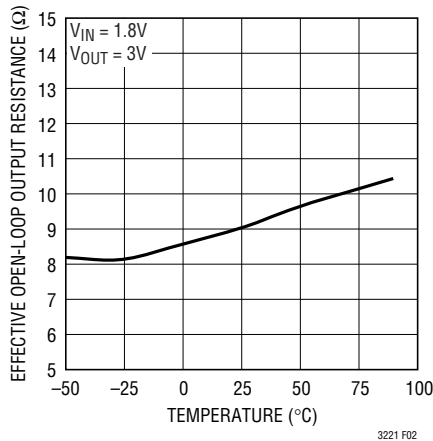

Figure 2. Effective Open-Loop Output Resistance vs Temperature

Output Ripple

Low frequency regulation mode ripple exists due to the hysteresis in the comparator CMP and propagation delay in the charge pump control circuit. The amplitude and frequency of this ripple are heavily dependent on the load current, the input voltage and the output capacitor size.

The LTC3221 family uses a controlled current, I_{SW} to deliver current to the output. This helps to keep the output ripple fairly constant over the full input voltage range. Typical combined output ripple for the LTC3221-3.3 with $V_{IN} = 2V$ under maximum load is $35mV_{P-P}$ using a $4.7\mu F$ 6.3V X5R case size 0603 output capacitor.

A high frequency ripple component may also be present on the output capacitor due to the charge transfer action of the charge pump. In this case the output can display a voltage pulse during the charging phase. This pulse results from the product of the charging current and the

ESR of the output capacitor. It is proportional to the input voltage, the value of the flying capacitor and the ESR of the output capacitor.

A smaller output capacitor and/ or larger output current load will result in higher ripple due to higher output voltage slew rates.

There are several ways to reduce output voltage ripple. For applications requiring lower peak-to-peak ripple, a larger C_{OUT} capacitor ($4.7\mu F$ or greater) is recommended. A larger capacitor will reduce both the low and high frequency ripple due to the lower charging and discharging slew rates, as well as the lower ESR typically found with higher value (larger case size) capacitors. A low ESR ceramic output capacitor will minimize the high frequency ripple, but will not reduce the low frequency ripple unless a high capacitance value is used.

V_{IN} , V_{OUT} Capacitor Selection

The style and value of capacitors used with the LTC3221 family determine several important parameters such as output ripple, charge pump strength and minimum start-up time.

To reduce noise and ripple, it is recommended that low ESR ($< 0.1\Omega$) capacitors be used for both C_{IN} and C_{OUT} . These capacitors should be either ceramic or tantalum and should be $2.2\mu F$ or greater. Aluminum capacitors are not recommended because of their high ESR.

Flying Capacitor Selection

Warning: A polarized capacitor such as tantalum or aluminum should never be used for the flying capacitor since its voltage can reverse upon start-up of the LTC3221. Low ESR ceramic capacitors should always be used for the flying capacitor.

The flying capacitor controls the strength of the charge pump. In order to achieve the rated output current, it is necessary to have at least $0.6\mu F$ of capacitance for the flying capacitor. For very light load applications, the flying capacitor may be reduced to save space or cost. From the first order approximation of R_{OL} in the section "Effective Open-Loop Output Resistance," the theoretical minimum output resistance of a voltage doubling charge pump can

APPLICATIONS INFORMATION

be expressed by the following equation:

$$R_{OL(MIN)} \cong \frac{2V_{IN} - V_{OUT}}{I_{OUT}} \cong \frac{1}{f_{OSC} \cdot C_{FLY}}$$

where f_{OSC} is the switching frequency (600kHz) and C_{FLY} is the value of the flying capacitor. The charge pump will typically be weaker than the theoretical limit due to additional switch resistance. However, for very light load applications, the above expression can be used as a guideline in determining a starting capacitor value.

Ceramic Capacitors

Capacitors of different materials lose their capacitance with higher temperature and voltage at different rates. For example, a ceramic capacitor made of X7R material will retain most of its capacitance from -40°C to 85°C , whereas, a Z5U or Y5V style capacitor will lose considerable capacitance over that range. Z5U and Y5V capacitors may also have a very strong voltage coefficient causing them to lose 50% or more of their capacitance when the rated voltage is applied. Therefore when comparing different capacitors, it is often more appropriate to compare the amount of achievable capacitance for a given case size rather than discussing the specified capacitance value. For example, over rated voltage and temperature conditions, a $1\mu\text{F}$ 10V Y5V ceramic capacitor in a 0603 case may not provide any more capacitance than a $0.22\mu\text{F}$ 10V X7R capacitor available in the same 0603 case. In fact, for most LTC3221-3.3/LTC3221-5/LTC3221 applications, these capacitors can be considered roughly equivalent. The capacitor manufacturer's data sheet should be consulted to determine what value of capacitor is needed to ensure $0.6\mu\text{F}$ at all temperatures and voltages.

Table 1 shows a list of ceramic capacitor manufacturers and how to contact them.

Table 1. Ceramic Capacitor Manufacturers

AVX	www.avxcorp.com
Kemet	www.kemet.com
Murata	www.murata.com
Taiyo Yuden	www.t-yuden.com
Vishay	www.vishay.com

Programming the LTC3221 Output Voltage (FB Pin)

While the LTC3221-3.3/LTC3221-5 versions have internal resistive dividers to program the output voltage, the programmable LTC3221 may be set to an arbitrary voltage via an external resistive divider. Figure 3 shows the required voltage divider connection.

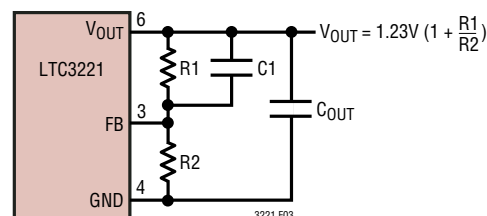

Figure 3. Programming the Adjustable LTC3221

The voltage divider ratio is given by the expression:

$$\frac{R1}{R2} = \frac{V_{OUT}}{1.23\text{V}} - 1$$

Since the LTC3221 employs a voltage doubling charge pump, it is not possible to achieve output voltages greater than twice the available input voltage. The V_{IN} supply range required for regulation is given by the following expression:

$$\text{Maximum } V_{IN} < V_{OUT} + 0.6$$

$$\text{Minimum } V_{IN} = \frac{(V_{OUT} + I_{OUT} \cdot R_{OL})}{2} \text{ or } 1.8\text{V};$$

whichever is higher

Where R_{OL} is the effective open-loop output resistance and I_{OUT} is the maximum load current. V_{IN} cannot be higher than V_{OUT} by more than 0.6V, or else the line regulation is poor. Also, V_{IN} has to be higher than the minimum operating voltage of 1.8V.

The sum of the voltage divider resistors can be made large to keep the quiescent current to a minimum. Any standing current in the output divider (given by $1.23/R2$) will be reflected by a factor of 2 in the input current. A reasonable resistance value should be such that the standing current is in the range of $10\mu\text{A}$ to $100\mu\text{A}$ when V_{OUT} is regulated.

APPLICATIONS INFORMATION

If the standing current is too low, the FB pin becomes very sensitive to the switching noise and will result in errors in the programmed V_{OUT} .

The compensation capacitor (C1) helps to improve the response time of the comparator and to keep the output ripple within an acceptable range. For best results, C1 should be between 22pF to 220pF.

Layout Considerations

Due to high switching frequency and high transient currents produced by the LTC3221 product family, careful board layout is necessary. A true ground plane and short

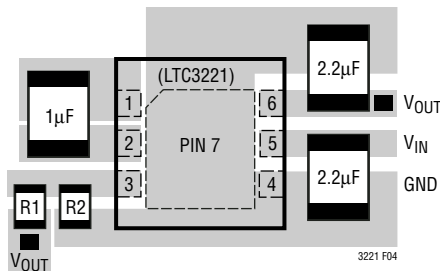

Figure 4. Recommended Layout

connections to all capacitors will improve performance and ensure proper regulation under all conditions. Figure 4 shows the recommended layout configuration.

The flying capacitor pins C^+ and C^- will have very high edge rate waveforms. The large dv/dt on these pins can couple energy capacitively to adjacent printed circuit board runs. Magnetic fields can also be generated if the flying capacitors are not close to the LTC3221 (i.e. the loop area is large). To decouple capacitive energy transfer, a Faraday shield may be used. This is a grounded PC trace between the sensitive node and the LTC3221 pins. For a high quality AC ground it should be returned to a solid ground plane that extends all the way to the LTC3221.

To reduce the maximum junction temperature due to power dissipation in the chip, a good thermal connection

to the PC board is recommended. Connecting the GND pin (Pin 4 and Pin 7 on the DFN package) to a ground plane, and maintaining a solid ground plane under the device can reduce the thermal resistance of the package and PC board considerably.

Derating Power at High Temperatures

To prevent an overtemperature condition in high power applications, Figure 5 should be used to determine the maximum combination of ambient temperature and power dissipation.

The power dissipated in the LTC3221 family should always fall under the line shown for a given ambient temperature. The power dissipation is given by the expression:

$$P_D = (2V_{IN} - V_{OUT}) \cdot I_{OUT}$$

This derating curve assumes a maximum thermal resistance, θ_{JA} , of $80^\circ\text{C}/\text{W}$ for $2\text{mm} \times 2\text{mm}$ DFN package.

This can be achieved from a printed circuit board layout with a solid ground plane and a good connection to the ground pins of the LTC3221 and the Exposed Pad of the DFN package. Operation out of this curve will cause the junction temperature to exceed 150°C which is the maximum junction temperature allowed.

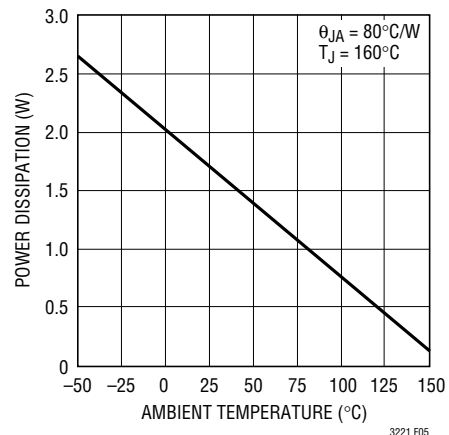
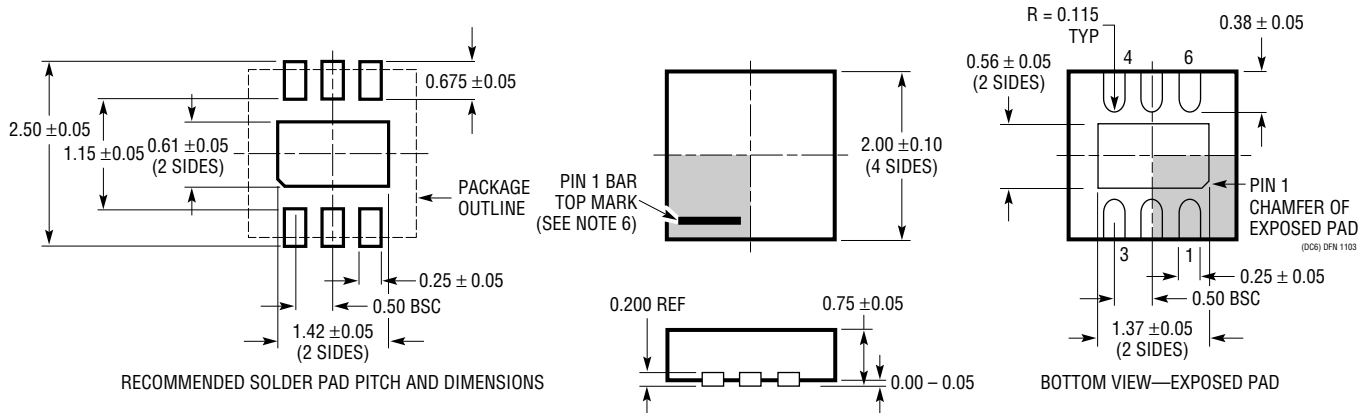

Figure 5. Maximum Power Dissipation vs Ambient Temperature

PACKAGE DESCRIPTION

DC Package
6-Lead Plastic DFN (2mm × 2mm)
(Reference LTC DWG # 05-08-1703)



NOTE:

1. DRAWING TO BE MADE A JEDEC PACKAGE OUTLINE M0-229 VARIATION OF (WCCD-2)
2. DRAWING NOT TO SCALE
3. ALL DIMENSIONS ARE IN MILLIMETERS
4. DIMENSIONS OF EXPOSED PAD ON BOTTOM OF PACKAGE DO NOT INCLUDE MOLD FLASH. MOLD FLASH, IF PRESENT, SHALL NOT EXCEED 0.15mm ON ANY SIDE
5. EXPOSED PAD SHALL BE SOLDER PLATED
6. SHADED AREA IS ONLY A REFERENCE FOR PIN 1 LOCATION ON THE TOP AND BOTTOM OF PACKAGE

LTC3221/ LTC3221-3.3/LTC3221-5

RELATED PARTS

PART NUMBER	DESCRIPTION	COMMENTS
LTC1262	12V, 30mA Flash Memory Program Supply	Regulated 12V \pm 5% Output, $I_Q = 500\mu\text{A}$
LTC1514/LTC1515	Buck/Boost Charge Pumps with $I_Q = 60\mu\text{A}$	50mA Output at 3.3V or 5V; 2V to 10V Input
LTC1516	Micropower 5V Charge Pump	$I_Q = 12\mu\text{A}$, Up to 50mA Output, $V_{IN} = 2\text{V}$ to 5V
LTC1517-5/LTC1517-3.3	Micropower 5V/3.3V Doubler Charge Pumps	$I_Q = 6\mu\text{A}$, Up to 20mA Output
LTC1522	Micropower 5V Doubler Charge Pump	$I_Q = 6\mu\text{A}$, Up to 20mA Output
LTC1555/LTC1556	SIM Card Interface	Step-Up/Step-Down Charge Pump, $V_{IN} = 2.7\text{V}$ to 10V
LTC1682	Low Noise Doubler Charge Pump	Output Noise = $60\mu\text{V}_{\text{RMS}}$, 2.5V to 5.5V Output
LTC1751-3.3/LTC1751-5	Micropower 5V/3.3V Doubler Charge Pumps	$I_Q = 20\mu\text{A}$, Up to 100mA Output, SOT-23 Package
LTC1754-3.3/LTC1754-5	Micropower 5V/3.3V Doubler Charge Pumps	$I_Q = 13\mu\text{A}$, Up to 50mA Output, SOT-23 Package
LTC1755	Smart Card Interface	Buck/Boost Charge Pump, $I_Q = 60\mu\text{A}$, $V_{IN} = 2.7\text{V}$ to 6V
LTC3200	Constant Frequency Doubler Charge Pump	Low Noise, 5V Output or Adjustable
LTC3203/LTC3203B/ LTC3203B-1/LTC3203-1	500mA Low Noise High Efficiency Dual Mode Step Up Charge Pumps	V_{IN} : 2.7V to 5.5V, 3mm \times 3mm DFN-10 Package
LTC3204/LTC3204B-3.3/ LTC3204-5	Low Noise Regulated Charge Pumps	Up to 150mA (LTC3204-5), Up to 50mA (LTC3204-3.3)
LTC3240-3.3/LTC3240-2.5	Step-Up/Step-Down Regulated Charge Pumps	Up to 150mA Output