

Mechanical Keyswitch with Sealed Construction for Automatic Soldering

- Available in two sizes:
6 mm square and 12 mm square
- Snap-action contact mechanism assures short key stroking and a sharp click to confirm input
- Ground terminal available to protect against static electricity
- Ideal for applications such as audio, office and communications equipment, measuring instruments, industrial robots, VCRs, TVs, and vending machines
- Stick (magazine) packaging style available: contact OMRON for details
- Sealed for CFC (Freon) cleaning

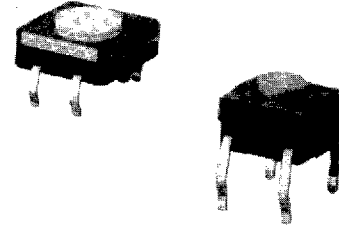

Ordering Information

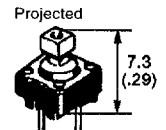
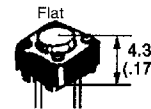

| Type | Plunger | Switch height x pitch | Operating Force | Part Number | | | |
|---------|-----------|-----------------------|------------------------|-------------------------|------------------|----------------------|------------------|
| | | | | Without ground terminal | | With ground terminal | |
| | | | | Bags | Sticks* | Bags | Sticks* |
| SPST-NO | Flat | 6 x 6 mm | General-purpose: 160 g | B3W-1000 | B3W-1000S | B3W-1100 | B3W-1100S |
| | | | High-force: 230 g | B3W-1002 | B3W-1002S | B3W-1102 | B3W-1102S |
| | Projected | 6 x 6 mm | General-purpose: 160 g | B3W-1050 | B3W-1050S | B3W-1150 | B3W-1150S |
| | | | High-force: 230 g | B3W-1052 | B3W-1052S | B3W-1152 | B3W-1152S |
| | Flat | 12 x 12 mm | General-purpose: 200 g | B3W-4000 | B3W-4000S | B3W-4100 | B3W-4100S |
| | | | High-force: 350 g | B3W-4005 | B3W-4005S | B3W-4105 | B3W-4105S |
| | Projected | 12 x 12 mm | General-purpose: 200 g | B3W-4050 | B3W-4050S | B3W-4150 | B3W-4150S |
| | | | High-force: 350 g | B3W-4055 | B3W-4055S | B3W-4155 | B3W-4155S |

* Number of switches per stick: **6 x 6 mm** Without ground terminal ... 80/stick
 With ground terminal 75/stick
12 x 12 mm Without ground terminal ... 45/stick
 With ground terminal 40/stick

Note: Switches cannot be water-washed.

■ ACCESSORIES

Keycaps

| Keycap color | Applicable type: | Part Number | | |
|--------------|------------------|-----------------|-----------------|-----------------|
| | | 6 x 6 mm | 12 x 12 mm | |
| | Size: | 4 x 4 mm | 9 x 9 mm | 12 x 12 mm |
| Light gray | | B32-1000 | B32-1200 | B32-1300 |
| Black | | B32-1010 | B32-1210 | B32-1310 |
| Orange | | B32-1020 | B32-1220 | B32-1320 |
| Yellow | | B32-1030 | B32-1230 | B32-1330 |
| Blue | | B32-1040 | B32-1240 | B32-1340 |
| Green | | B32-1050 | B32-1250 | B32-1350 |
| White | | B32-1060 | B32-1260 | B32-1360 |
| Light green | | B32-1070 | B32-1270 | B32-1370 |
| Red | | B32-1080 | B32-1280 | B32-1380 |

Note: Keycaps are available in different sizes and colors for exclusive use with the 6 x 6 mm and 12 x 12 mm projected plunger version of Model B3W.

Plunger Identification Table

Use this table to determine keyswitch type by plunger color.

| Plunger color | Operating force | Type |
|---------------|-----------------|----------------------------|
| White | 160 g | B3W-1000, 1050, 1100, 1150 |
| White | 200 g | B3W-4000, 4050, 4100, 4150 |
| Yellow | 230 g | B3W-1002, 1052, 1102, 1152 |
| Yellow | 350 g | B3W-4005, 4055, 4105, 4155 |

■ CONSTRUCTION

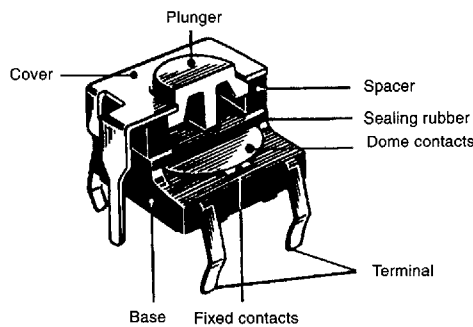

Characteristics

| | | | |
|---|------------------------|--|---------------------------|
| Switching capacity | | 50 mA 24 VDC (resistive load) | |
| Permissible load | | 1 mA 5 VDC min. (resistive load) | |
| Contact resistance | | 100 M Ω max. | |
| Insulation resistance | | 100 M Ω min. (at 250 VDC) | |
| Dielectric strength | | 500 VAC, 50/60 Hz for 1 minute | |
| Bounce time | | 5 ms max. | |
| Vibration | Malfunction durability | 10 to 55 Hz, 1.5 mm double amplitude | |
| Shock | Mechanical durability | 1,000 m/s ² (approx. 100 G) | |
| | Malfunction durability | 100 m/s ² (approx. 10 G) | |
| Ambient temperature | Operating | -25° to 70°C | |
| Humidity | | 35% to 85% RH | |
| Service life [mechanical/electrical] | | B3W-1□□□ | B3W-4□□□ |
| | General-purpose type | 1,000,000 operations min. | 3,000,000 operations min. |
| | High-load type | 300,000 operations min. | 1,000,000 operations min. |
| Weight | | B3W-1□□□ | B3W-4□□□ |
| | | Approx. 0.30 g | Approx. 1.00 g |

■ CHARACTERISTIC DATA

Operating force vs. stroke
(typical example)
B3W-1□□□ series

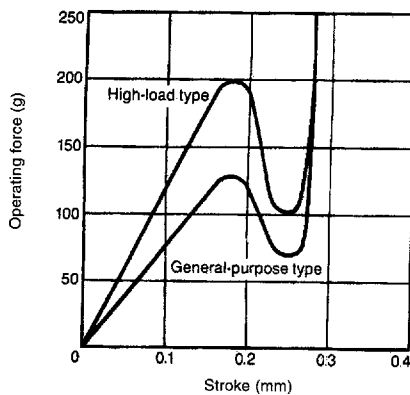

B3W-4□□□ series

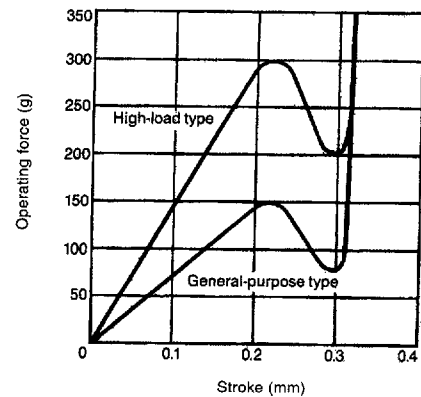

■ OPERATING CHARACTERISTICS

| | B3W-1□□□ | | B3W-4□□□ | |
|---------------------------|---|---|--|--|
| | General-purpose | High-force | General-purpose | High-force |
| Operating force (OF) max. | 160 g | 230 g | 200 g | 350 g |
| Release force (RF) min. | 20 g | 50 g | 30 g | 50 g |
| Pretravel (PT) | 0.25 ^{+0.2} / _{-0.1} mm | 0.25 ^{+0.2} / _{-0.1} mm | 0.3 ^{+0.2} / _{-0.1} mm | 0.3 ^{+0.2} / _{-0.1} mm |

Dimensions

Unit: mm (inch)

■ 6 MM SQUARE TYPES

B3W-1000, B3W-1002

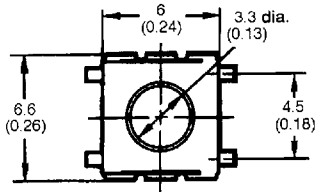

B3W-1100, B3W-1102

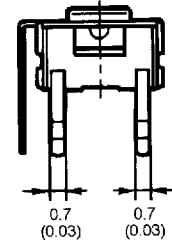
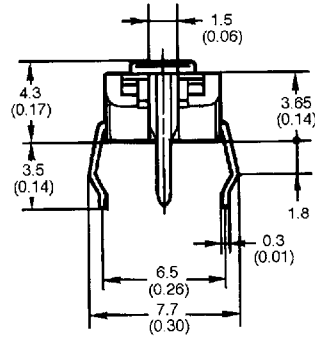
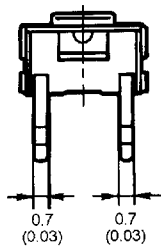
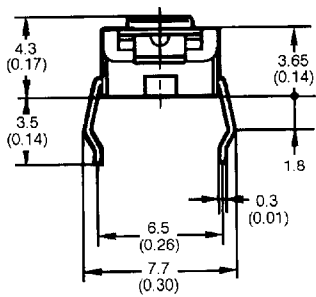
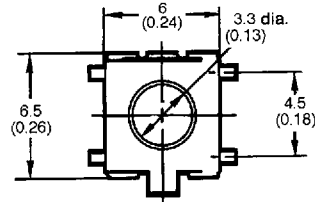

Mounting holes in PCB (top view)

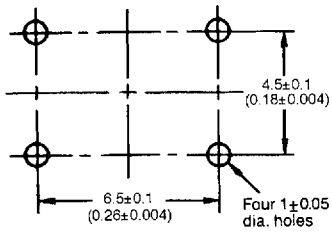

Terminal arrangement/ Internal connection (top view)

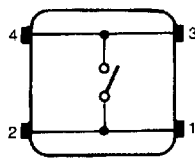

Mounting holes in PCB (top view)

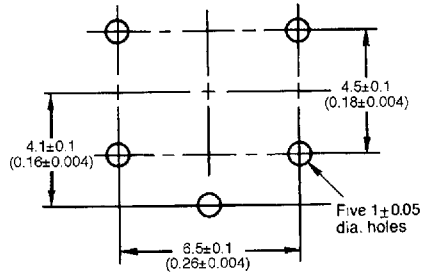

Terminal arrangement/ Internal connection (top view)

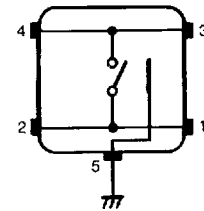

Note: Unless otherwise specified, a tolerance of ± 0.2 mm applies to all dimensions.

■ 6 MM SQUARE TYPES

B3W-1050, B3W-1052

B3W-1150, B3W-1152

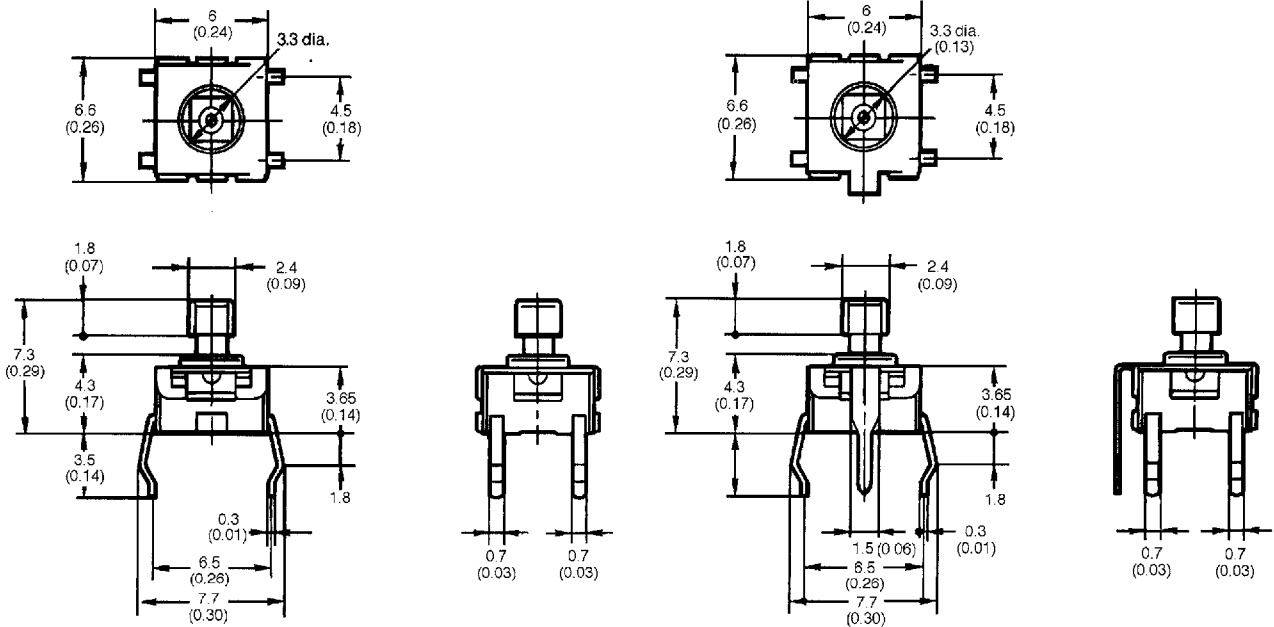

Mounting holes in PCB (top view)

Terminal arrangement/ Internal connection (top view)

Mounting holes in PCB (top view)

Terminal arrangement/ Internal connection (top view)

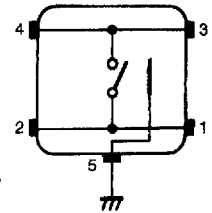
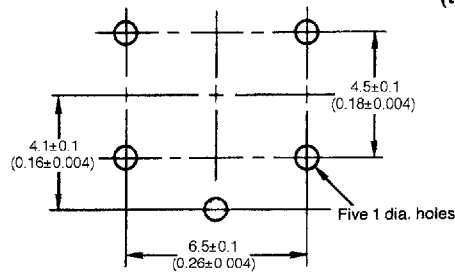
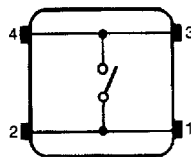
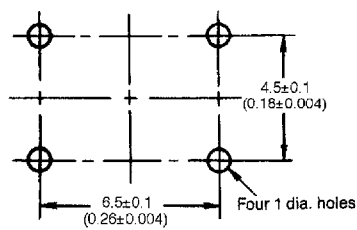

Note: Unless otherwise specified, a tolerance of ± 0.2 mm applies to all dimensions.

2

Unit: mm (inch)

■ 12 MM SQUARE TYPES

B3W-4000, B3W-4005

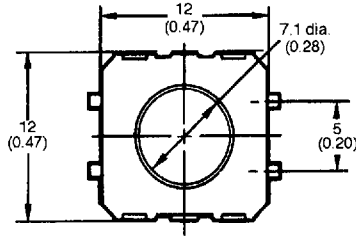

B3W-4100, B3W-4105

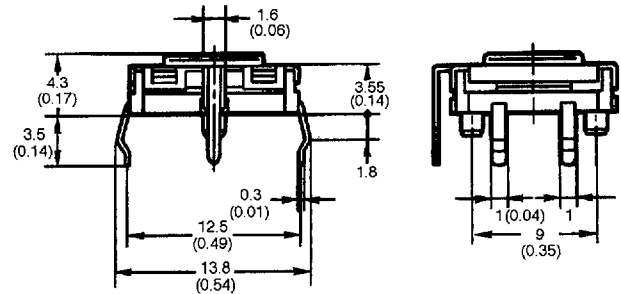
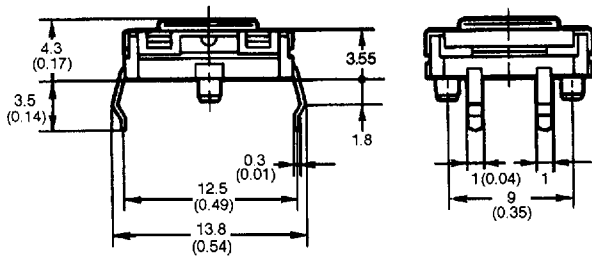
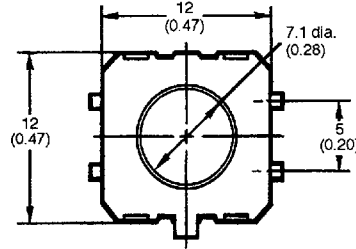

Mounting holes in PCB (top view)

Terminal arrangement/ Internal connection (top view)

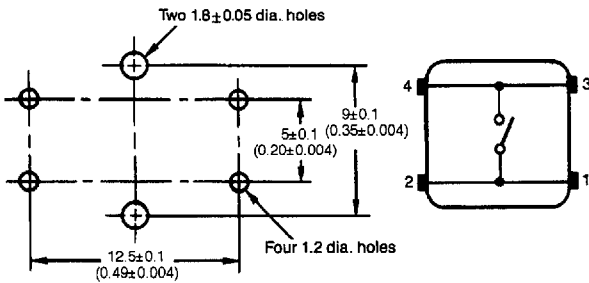

Mounting holes in PCB (top view)

Terminal arrangement/ Internal connection (top view)

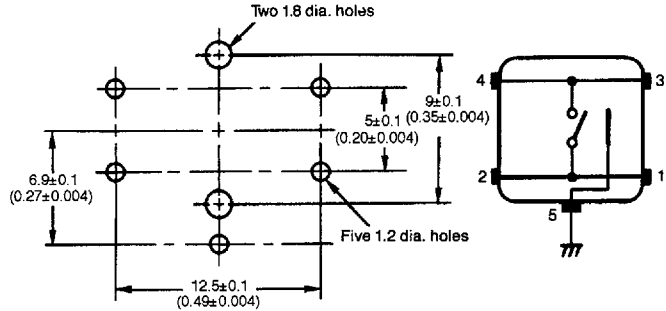

Note: Unless otherwise specified, a tolerance of ± 0.2 mm applies to all dimensions.

■ 12 MM SQUARE TYPES

B3W-4050, B3W-4055

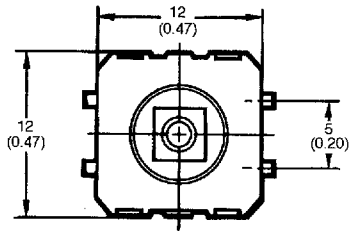

B3W-4150, B3W-4155

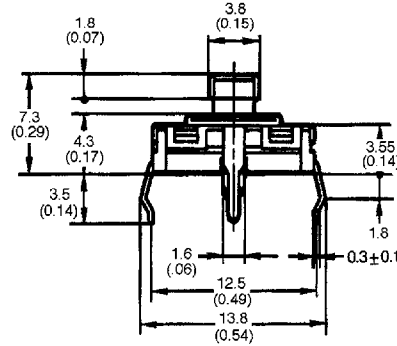
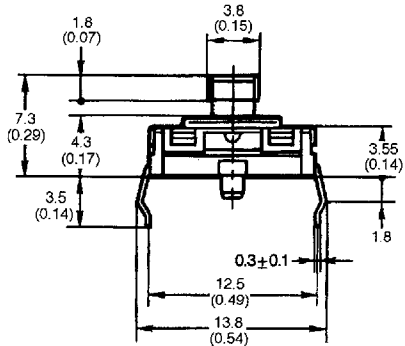
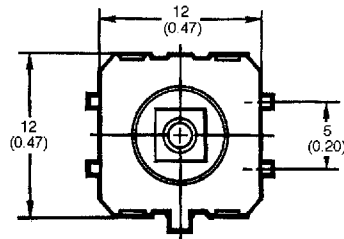

Mounting holes in PCB (top view)

Terminal arrangement/ Internal connection (top view)

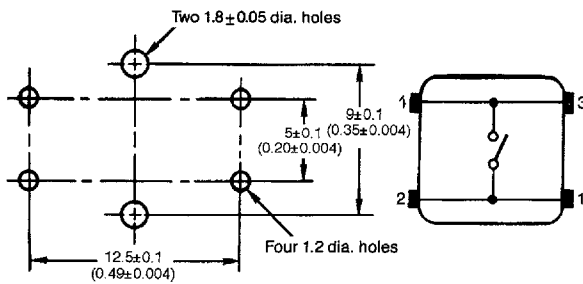

Mounting holes in PCB (top view)

Terminal arrangement/ Internal connection (top view)

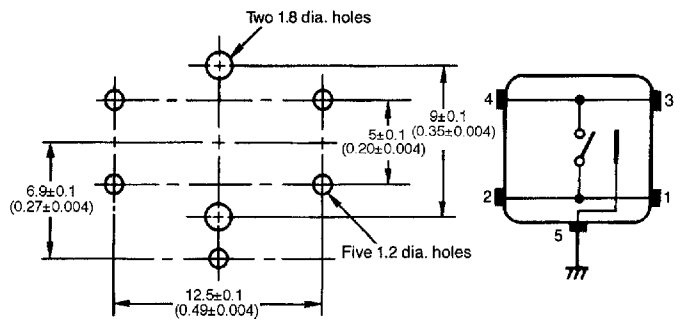

Note: Unless otherwise specified, a tolerance of ± 0.2 mm applies to all dimensions.

Unit: mm (inch)

KEYCAPS

B32-10 0

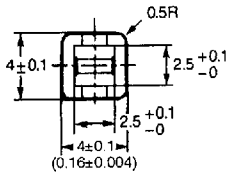
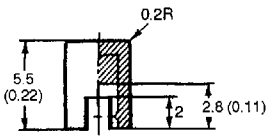

B32-12 0

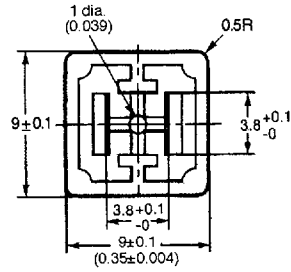
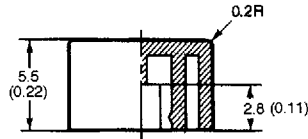

B32-13 0

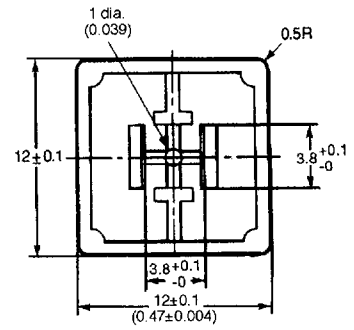
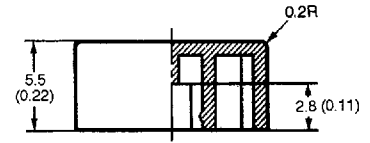

Note: Unless otherwise specified, a tolerance of ± 0.2 mm applies to all dimensions.