

Low I_Q , Low Dropout 300mA Fixed Voltage Regulator

Features

- Low Quiescent Current : 50uA (No load)
- Low Dropout Voltage : 400mV
($V_{OUT}(\text{Nominal})=3.0\text{V}$ Version @300mA)
- Very low Shutdown Current : < 0.5uA
- Fixed Output Voltage : 1.3V ~ 5.0V
by step 0.1V increment
- Stable with 1uF Output Capacitor
- Stable with Aluminum, Tantalum or Ceramic Capacitors .
- Reverse Current Protection
- No Protection Diodes Needed
- Built in Thermal Protection
- Built in Current Limit Protection
- Controlled Short Circuit Current : 50mA
- Fast Transient Response
- Short Setting Time
- SOP-8, SOT-23, SOT-23-5, SOT-89,
and SOT-89-5 Packages

Applications

- Notebook Computer
- PDA or Portable Equipments
- Noise-Sensitive Instrumentation Systems

General Description

The APL5301/2 series are micropower, low noise, low dropout linear regulators, which operate from 3V to 6V input voltage and deliver up to 300mA. Typical dropout voltage is only 260mV at 300mA loading. Designed for use in battery-powered system, the low 50uA quiescent current makes it an ideal choice. Design with an internal P-channel MOSFET pass transistor, the APL5301/2 maintain a low supply current, independent of the load current and dropout voltage. Other features include reverse current protection, thermal-shutdown protection, current limit protection to ensure specified output current and controlled short-circuit current. The APL5301/2 regulators come in a miniature SOP-8, SOT-23, SOT-23-5, SOT-89 and SOT-89-5 packages.

Pin Configuration

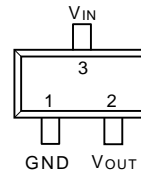

SOT-23 (Top View)
APL5301

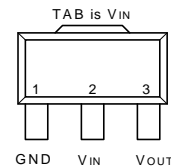

SOT-89 (Top View)
APL5301

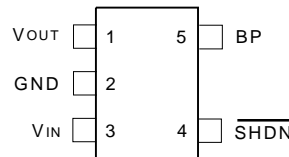

SOT-23-5 (Top View)
APL5301

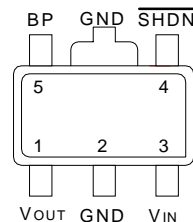

SOT-89-5 (Top View)
APL5301

ANPEC reserves the right to make changes to improve reliability or manufacturability without notice, and advise customers to obtain the latest version of relevant information to verify before placing orders.

Pin Configuration (Cont.)

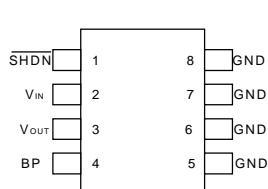

SOP-8 (Top View)

APL5301

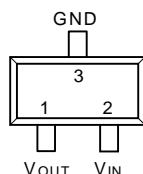

SOT-23 (Top View)

APL5302

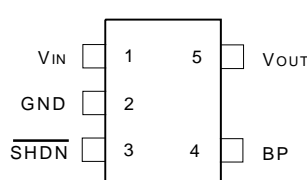

SOT-23-5 (Top View)

APL5302

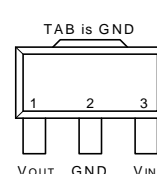

SOT-89 (Top View)

APL5302

Ordering and Marking Information

<p>APL5301/2 - □□□□-□□□□</p> <ul style="list-style-type: none"> □□□□ - Lead Free Code □□□□ - Handling Code □□□□ - Temp. Range □□□□ - Package Code □□□□ - Voltage Code 	<p>Package Code A : SOT-23 B : SOT-23-5 D : SOT-89 D5 : SOT-89-5 K : SOP-8 Temp. Range C : 0 to 70 °C I : -40 to 85 °C Handling Code TR : Tape & Reel Voltage Code : 13 : 1.3V ~ 34 : 3.4V 50 : 5.0V Lead Free Code L : Lead Free Device Blank : Original Device</p>
<p>APL5301/2 -13 D/K : APL5301/2 XXXXX 13</p>	<p>XXXXX - Date Code ; 13 - 1.3V</p>

Marking Information

SOT-23 and SOT-23-5 packages

Product Name	Marking	Product Name	Marking
APL5301-13A/B	317X	APL5302-13A/B	327X
APL5301-14A/B	318X	APL5302-14A/B	328X
APL5301-15A/B	319X	APL5302-15A/B	329X
APL5301-16A/B	31AX	APL5302-16A/B	32AX
APL5301-17A/B	31BX	APL5302-17A/B	32BX
APL5301-18A/B	31CX	APL5302-18A/B	32CX
APL5301-19A/B	31DX	APL5302-19A/B	32DX
APL5301-20A/B	31EX	APL5302-20A/B	32EX
APL5301-21A/B	31FX	APL5302-21A/B	32FX
APL5301-22A/B	31GX	APL5302-22A/B	32GX
APL5301-23A/B	31HX	APL5302-23A/B	32HX
APL5301-24A/B	31IX	APL5302-24A/B	32IX
APL5301-25A/B	31JX	APL5302-25A/B	32JX
APL5301-26A/B	31KX	APL5302-26A/B	32KX
APL5301-27A/B	31LX	APL5302-27A/B	32LX
APL5301-28A/B	31MX	APL5302-28A/B	32MX
APL5301-29A/B	31NX	APL5302-29A/B	32NX
APL5301-30A/B	31OX	APL5302-30A/B	32OX
APL5301-31A/B	31PX	APL5302-31A/B	32PX

Marking Information (Cont.)

SOT-23 and SOT-23-5 packages

Product Name	Marking	Product Name	Marking
APL5301-32A/B	31QX	APL5302-32A/B	32QX
APL5301-33A/B	31RX	APL5302-33A/B	32RX
APL5301-34A/B	31SX	APL5302-34A/B	32SX
APL5301-35A/B	31TX	APL5302-35A/B	32TX
APL5301-48A/B	31XX	APL5302-48A/B	32XX
APL5301-49A/B	31YX	APL5302-49A/B	32YX
APL5301-50A/B	31ZX	APL5302-50A/B	32ZX

The last character "X" in the marking is for data code.

Pin Description

PIN		I/O	Description
No.	Name		
1	V _{IN}	I	Supply voltage input.
2	GND		Ground pins of the circuitry, and all ground pins must be soldered To PCB with proper power dissipation.
3	$\overline{\text{SHDN}}$ ^(Note1)	I	Shutdown control pin, low = off, high = normal. Don't leave open.
4	BP ^(Note1)	O	Bypass signal pin of the regulator.
5	V _{OUT}	O	Output pin of the regulator.

Note1 : This pin does not exist in 3-pin package.

Absolute Maximum Ratings

Symbol	Parameter	Rating	Unit
V _{IN} , V _{OUT}	Input Voltage or Out Voltage	6.5	V
$\overline{\text{SHDN}}$	Shutdown Control Pin	6.5	V
R _{TH,JA}	Thermal Resistance – Junction to Ambient	357	°C/W
P _D	Power Dissipation	Internally Limited	W
T _J	Operating Junction Temperature		°C
	Control Section	0 to 125	
	Power Transistor	0 to 150	
T _{STG}	Storage Temperature Range	-65 to +150	°C
T _L	Lead Temperature (Soldering, 10 second)	260	°C

Electrical Characteristics

Unless otherwise noted these specifications apply over full temperature, $V_{IN}=3.8V$, $C_{IN}=C_{OUT}=1\mu F$, $\overline{SHDN}=V_{IN}$, $T_J=0$ to $125^\circ C$. Typical values refer to $T_J=25^\circ C$.

Symbol	Parameter	Test Conditions	APL5301/2			Unit
			Min.	Typ.	Max.	
V_{IN}	Input Voltage		2.7		6.5	V
V_{OUT}	Output Voltage	$V_{OUT}+1.0V < V_{CC} < 6.0V$, $0mA < I_{OUT}$	$V_{OUT} - 2\%$	V_{OUT}	$V_{OUT} + 2\%$	V
I_{LIMIT}	Circuit Current Limit	$V_{IN}=V_{OUT}+0.5V$		500		mA
I_{SHORT}	Short Current	$V_{OUT}=0V$		50		mA
I_{OUT}	Load Current	$V_{IN}=V_{OUT}+0.5V$	300			mA
REG_{LINE}	Line Regulation	$V_{OUT}+0.5V < V_{CC} < 6.0V$, $I_{OUT}=150mA$		4	10	mV
REG_{LOA}	Load Regulation	$V_{IN} = V_{OUT}+0.5V$, $0mA < I_{OUT} < I_{MAX}$		1	6	mV
	Load Transient	$V_{IN} = V_{OUT}+0.5V$, $I_{OUT}=1mA-150mA$ in $1\mu s$		70	150	mV mV
V_{DROP}	Dropout Voltage ^(Note2)	$I_{OUT} = 300mA$	$1.3V \leq V_{OUT} < 1.5V$	1.2	1.6	V
			$1.5V \leq V_{OUT} < 2.0V$	1	1.2	
			$2.0V \leq V_{OUT} < 2.5V$	0.8	0.9	
			$2.5V \leq V_{OUT} < 3V$	0.6	0.7	
			$3V \leq V_{OUT} \leq 5V$	0.4	0.5	
PSRR	Ripple Rejection	$F \leq 1kHz$, $1V_{pp}$ at $V_{IN} = V_{OUT}+1.0V$	45	55		dB
I_Q	Quiescent Current	No load		50	80	μA
		$I_{OUT}=300mA$		150	180	
	Shutdown Supply Current ^(Note3)	Shutdown = low $I_{OUT}=0$, $V_{CC}=6.0V$		0.01	1	μA
	Noise	$100Hz < f < 100kHz$, typical load, $C_{BP}=0.01\mu F$, $C_{OUT} = 1\mu F$		200		μV_{rms}
	Shutdown Recovery Delay ^(Note3)	$C_{BP}=0.01\mu F$, $C_{OUT}=1\mu F$, no load		0.4		ms
OTS	Over Temperature Shutdown			150		$^\circ C$
	Over Temperature Shutdown Hysteresis	Hysteresis		10		$^\circ C$
TC	Output Voltage Temperature Coefficient			50		ppm/ $^\circ C$
C_{OUT}	Output Capacitor		0.8	1.0	2.6	μF
	ESR		0.02	0.1	1	Ohm
	Shutdown Input Threshold ^(Note3)	$V_{OUT}+1.0V < V_{IN} < 6.0V$	0.4	1.6	2.5	V

Electrical Characteristics (Cont.)

Symbol	Parameter	Test Conditions	APL5301/2			Unit
			Min.	Typ.	Max.	
$I_{\overline{\text{SHDN}}}$	Shutdown input Bias current ^(Note3)	$V_{\overline{\text{SHDN}}} = V_{\text{IN}}$		0.01	100	nA
	Input Reverse Leakage current	$V_{\text{OUT}} - V_{\text{IN}} = 0.1\text{V}$		0.1	0.5	μA
	Reverse Protection Threshold			11	50	mV

Note2 : Dropout voltage definition : $V_{\text{IN}} - V_{\text{OUT}}$ when V_{OUT} is 2% below the value of V_{OUT} for $V_{\text{IN}} = V_{\text{OUT}} + 0.5\text{V}$

Note3 : For 5-pin devices only.

Application Circuit

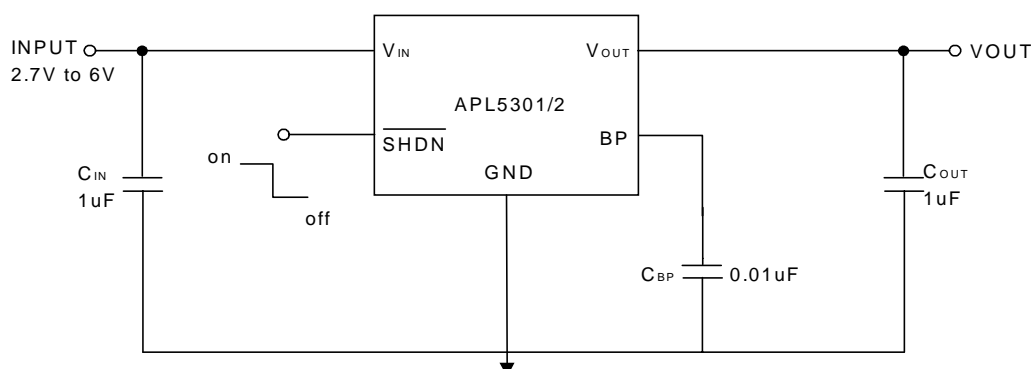

Typical Characteristics

(All Curves are For Fix 3.3V)

Output Voltage vs. Temperature

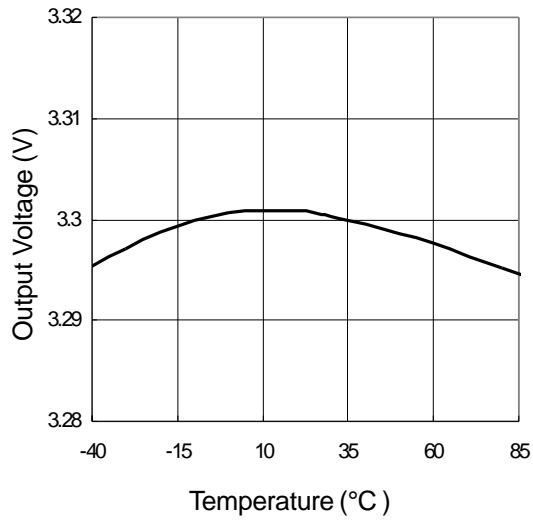

Ground Pin Current vs. Load Current

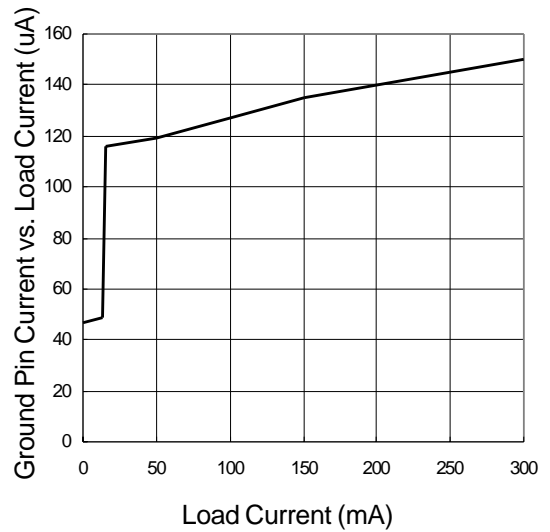

Ground Pin Current vs. Input Voltage

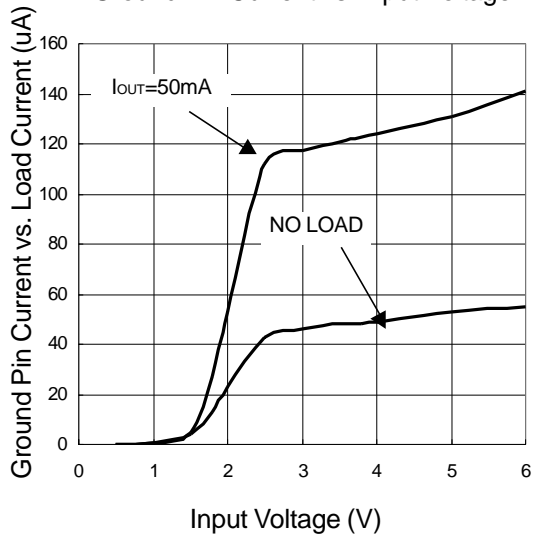

Input Voltage vs. Output Voltage

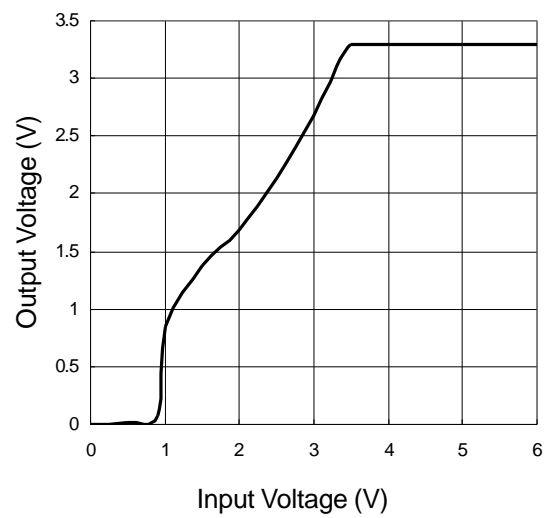

Typical Characteristics

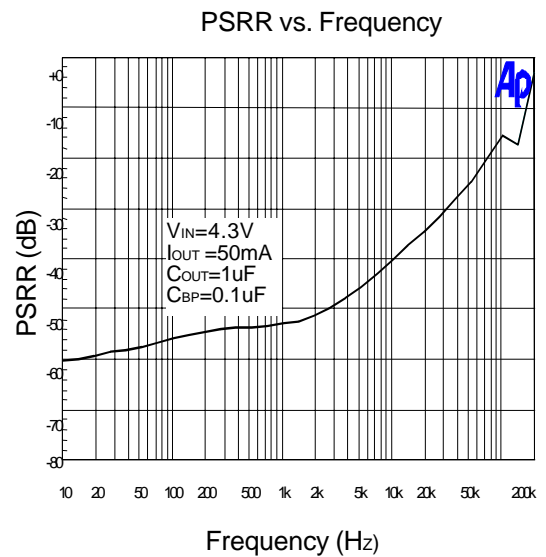
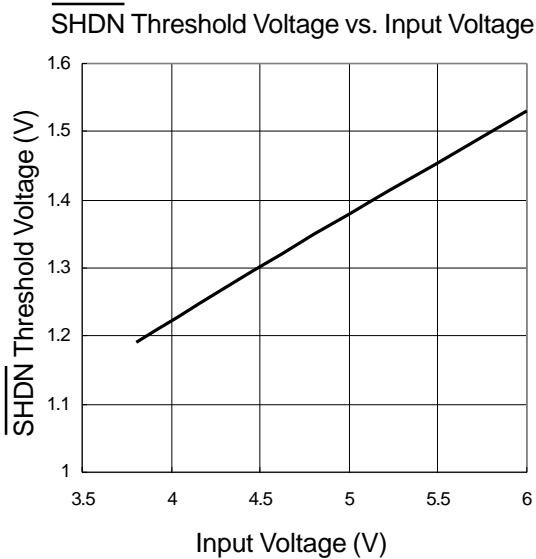
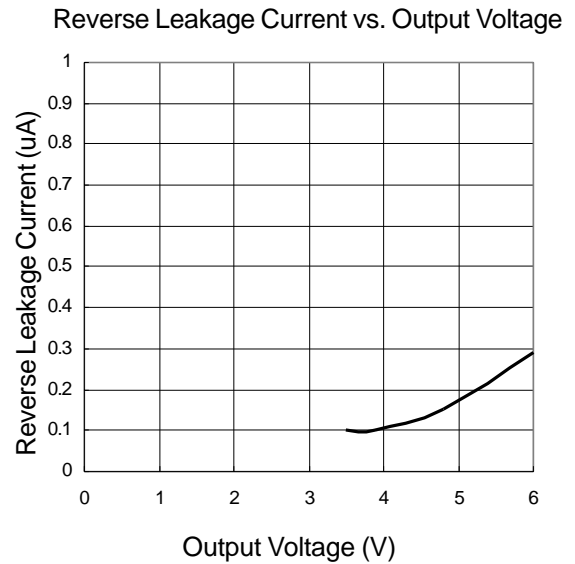
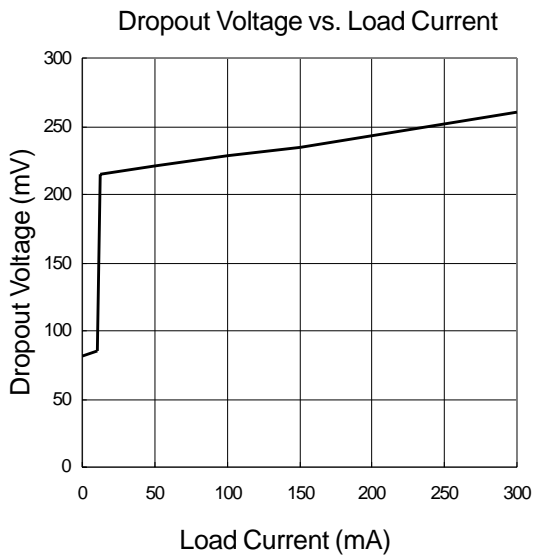

Typical Characteristics

Load-Transient Response

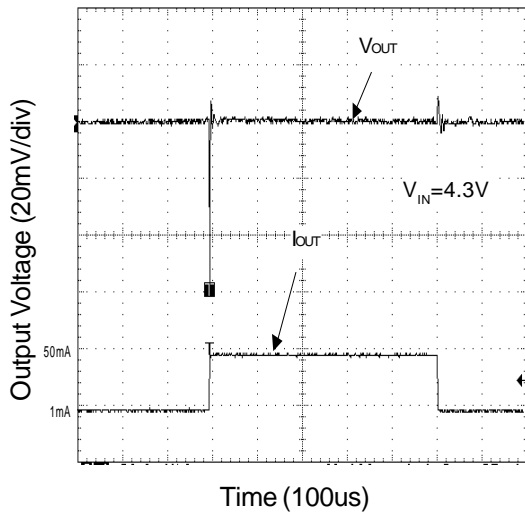

Line-Transient Response

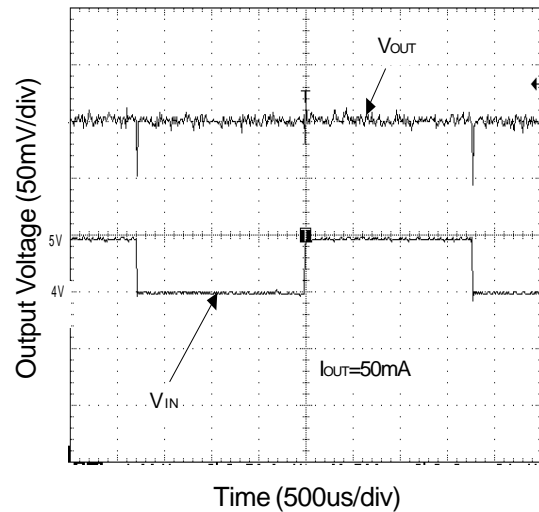

Entering Shutdown

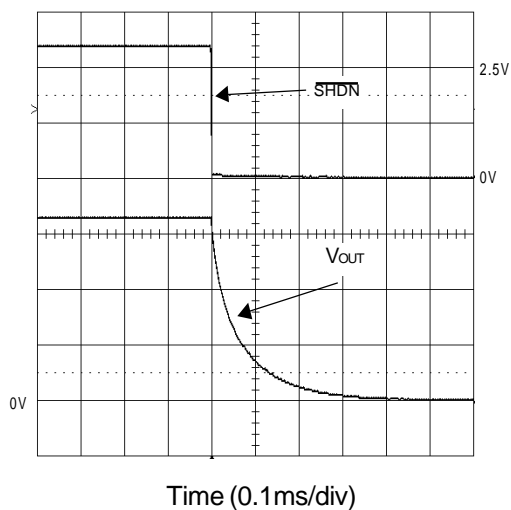

Shutdown Exit Delay

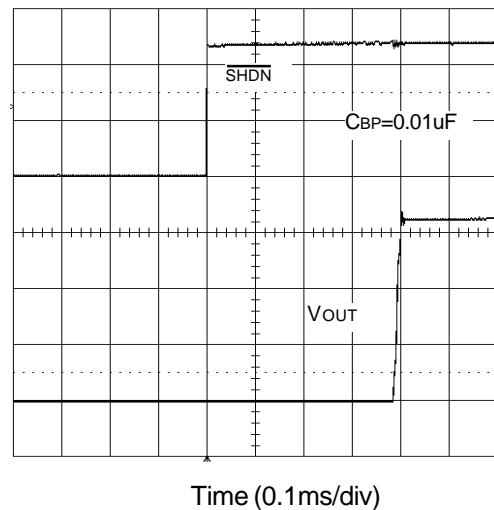

Typical Characteristics

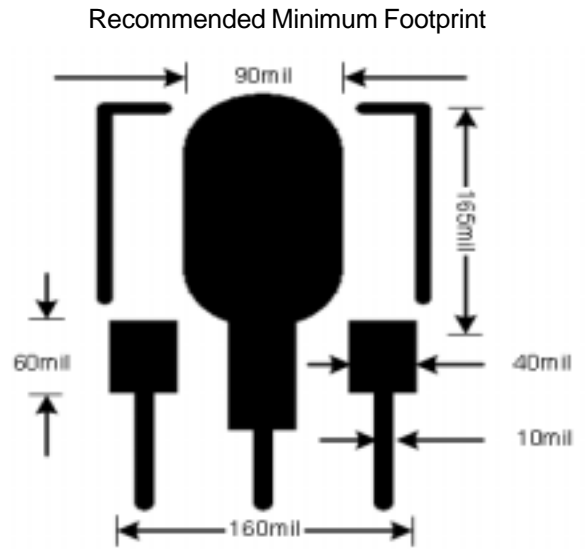
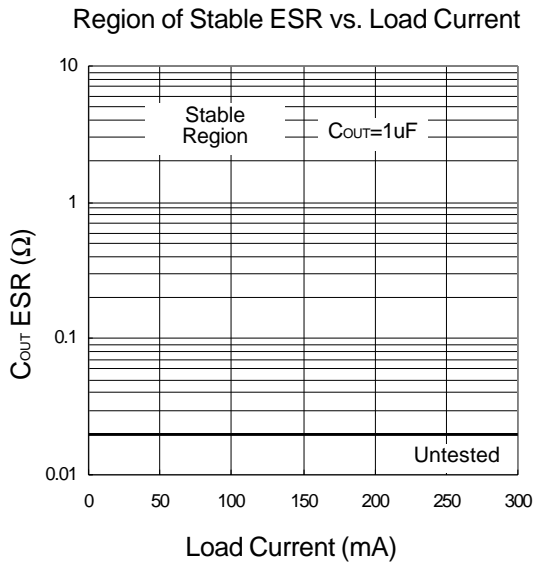

Application Information

Capacitor Selection and Regulator Stability

The APL5301/2 use at least a 1 μ F capacitor on the input, and this capacitor can be Aluminum, Tantalum or Ceramic capacitor. The input capacitor with larger value and lower ESR provides better PSRR and line-transient response. The output capacitor also can use Aluminum, Tantalum or Ceramic capacitor, and a minimum value of 1 μ F and ESR above 0.06 Ω is recommended. The curve of the stable region in typical characteristics shows the appropriate output capacitor ESR for different load current stable operation. A larger output capacitor can reduce noise and improve load-transient response, stability, and PSRR. Note that some ceramic dielectrics exhibit large capacitance and ESR variation with temperature. When using this capacitor, a minimum 2.2 μ F or more may be required to ensure the stability at low temperature operation. Use a bypass capacitor at BP pin for low output noise. Increasing the capacitance will slightly decrease the output noise, but increase the start-up time. (See Shutdown Exit Delay and Output Noise vs. Bypass Capacitor graph in the typical characteristics)

Load-Transient Considerations

The APL5301/2 load-transient response graphs in typical characteristics show the transient response. A step change in the load current from 1mA to 50mA at 1 μ s will cause a 60mV transient spike. Larger output capacitor and lower ESR can reduce transient spike.

Input-Output (Dropout)Voltage

The minimum input-output voltage difference (dropout) determines the lowest usable supply voltage. In bat

tery-powered systems, this will determine the useful end-of-life battery voltage. Because the APL5301/2 use a p-channel MOSFET pass transistor, the dropout voltage is a function of drain-to-source on-resistance ($R_{DS(ON)}$) multiplied by the load current.

Reverse Current Protection

The APL5301/2 have an internal reverse protection, it does not need an external schottky diode to connect the regulator input and output. If the output voltage is forced above the input voltage by more than 11mV, the IC will be shutdown and the ground pin current is below 0.1 μ A.

Shutdown/Enable

The APL5301/2 have an active high enable function. Force EN high (>1.6V) enables the regulator, EN low (<0.4V) disables the regulator and enter the shutdown mode. In shutdown mode, the quiescent current can reduce below 1 μ A. The EN pin cannot be floating, a floating EN pin may cause an indeterminate state on the output. If it is no use, connect to V_{IN} for normal operation.

Current Limit

The APL5301/2 have a current limit protection. The output voltage will drop close to zero volt, when load current reaches the limit, and then the load current will be limited at 50mA after output voltage is below 0.7V. When the load current back to the value where limiting started, the output voltage and current will return to normal value. When output is shorted to ground, the APL5301/2 will keep short circuit current at 150mA .

Thermal Protection

Thermal protection limits total power dissipation in the device. When the junction temperature exceeds $T_{j,+150^{\circ}\text{C}}$, the thermal sensor generates a logic signal to turn off the pass transistor and allows IC to cool. When the IC's junction temperature is down by 10°C , the thermal sensor will turn the pass transistor on again, resulting in a pulsed output during continuous thermal protection. Thermal protection is designed to protect the APL5301/2 in the event of fault conditions. For continuous operation, do not exceed the absolute maximum junction temperature of $T_{j,+150^{\circ}\text{C}}$.

Operating Region and Power Dissipation

The thermal resistance of the case to circuit board, and the rate of air flow all control the APL5301/2's maximum power dissipation. The power dissipation across the device is $P_D = I_{\text{OUT}}(V_{\text{IN}} - V_{\text{OUT}})$ and the maximum power dissipation is:

$$P_{\text{DMAX}} = (T_J - T_A) / (\theta_{\text{JC}} + \theta_{\text{CA}})$$

where $T_J - T_A$ is the temperature difference between the junction and ambient air, θ_{JC} is the thermal resistance of the package, and θ_{CA} is the thermal resistance through the printed circuit board, copper traces, and other materials to the ambient air.

The GND pin of the APL5301 and APL5302 that the packages are SOT-23-5, SOT-89-5 AND SOP-8 provide an electrical connection to ground and channeling heat away. If power dissipation is large, connect the GND pin to ground using a large pad or ground plane, can improve the problem of over heat of IC.

Packaging Information

SOP-8 pin (Reference JEDEC Registration MS-012)

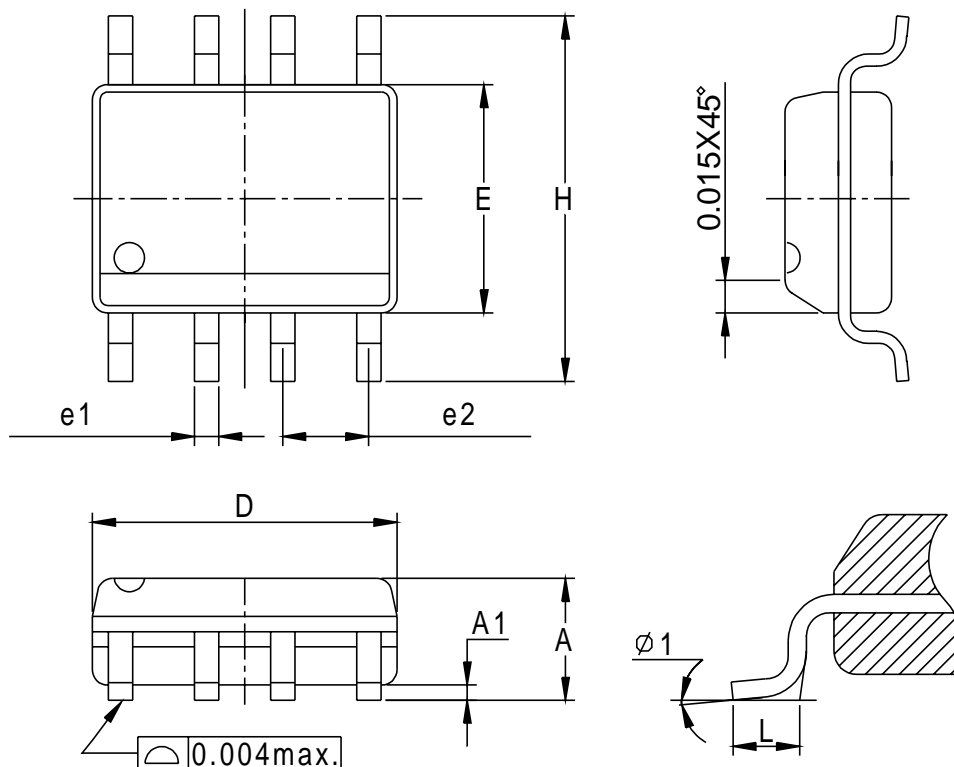

Dim	Millimeters		Inches	
	Min.	Max.	Min.	Max.
A	1.35	1.75	0.053	0.069
A1	0.10	0.25	0.004	0.010
D	4.80	5.00	0.189	0.197
E	3.80	4.00	0.150	0.157
H	5.80	6.20	0.228	0.244
L	0.40	1.27	0.016	0.050
e1	0.33	0.51	0.013	0.020
e2	1.27BSC		0.50BSC	
φ 1	8°		8°	

Packaging Information

SOT-23

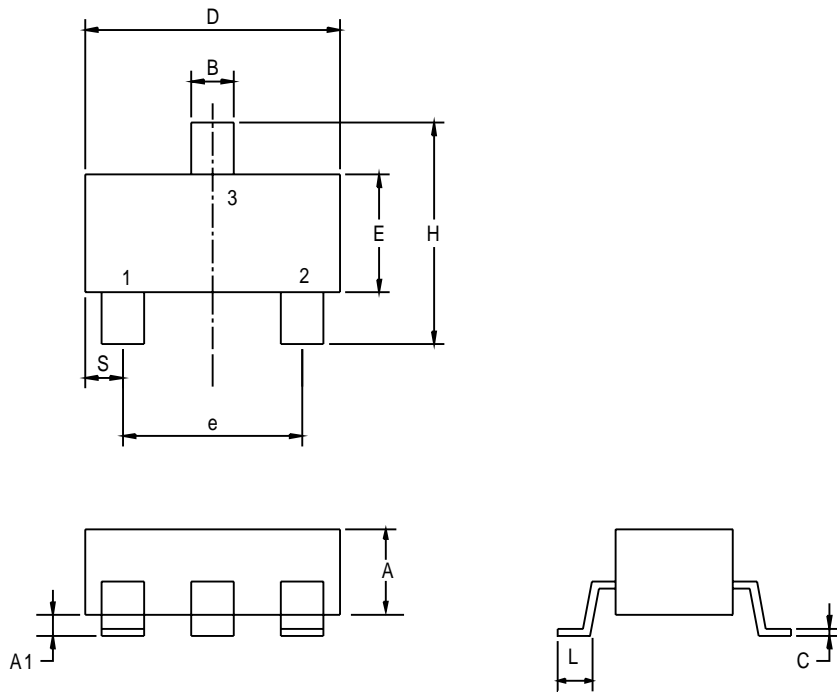

Dim	Millimeters		Inches	
	Min.	Max.	Min.	Max.
A	1.00	1.30	0.039	0.051
A1	0.00	0.10	0.000	0.004
B	0.35	0.51	0.014	0.020
C	0.10	0.25	0.004	0.010
D	2.70	3.10	0.106	0.122
E	1.40	1.80	0.055	0.071
e	1.90 BSC		0.075 BSC	
H	2.40	3.00	0.094	0.118
L	0.37		0.0015	

Packaging Information

SOT-23-5

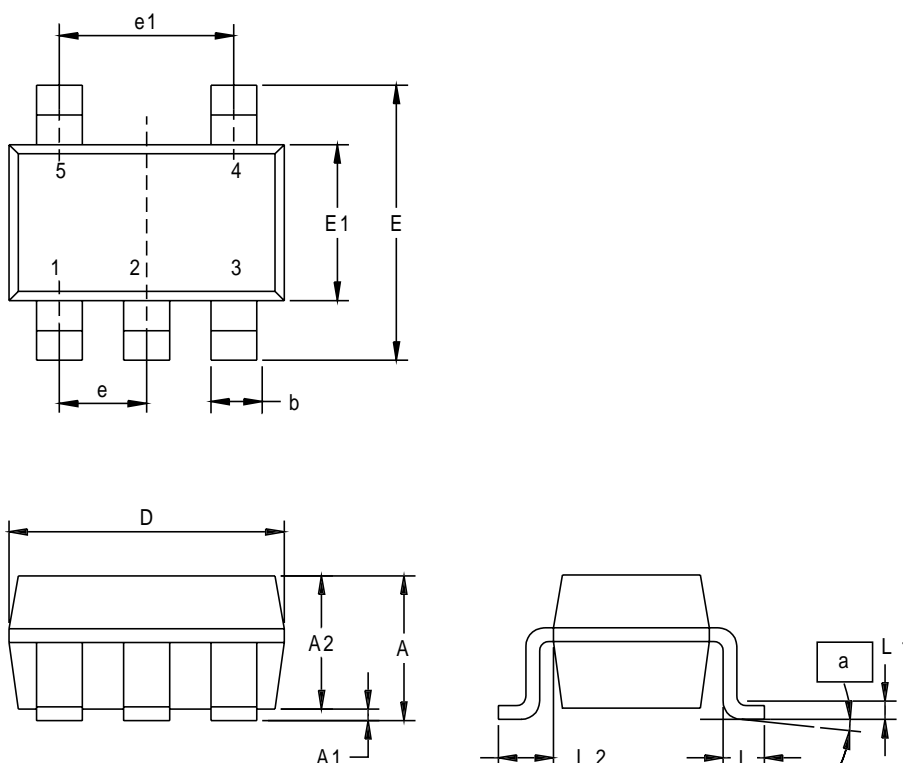

Dim	Millimeters		Inches	
	Min.	Max.	Min.	Max.
A	0.95	1.45	0.037	0.057
A1	0.05	0.15	0.002	0.006
A2	0.90	1.30	0.035	0.051
D	2.8	3.00	0.110	0.118
E	2.6	3.00	0.102	0.118
E1	1.5	1.70	0.059	0.067
L	0.35	0.55	0.014	0.022
L1	0.20 BSC		0.008 BSC	
L2	0.5	0.7	0.020	0.028
N	5		5	
α	0°	10°	0°	10°

Packaging Information

SOT-89 (Reference EIAJ ED-7500A Registration SC-62)

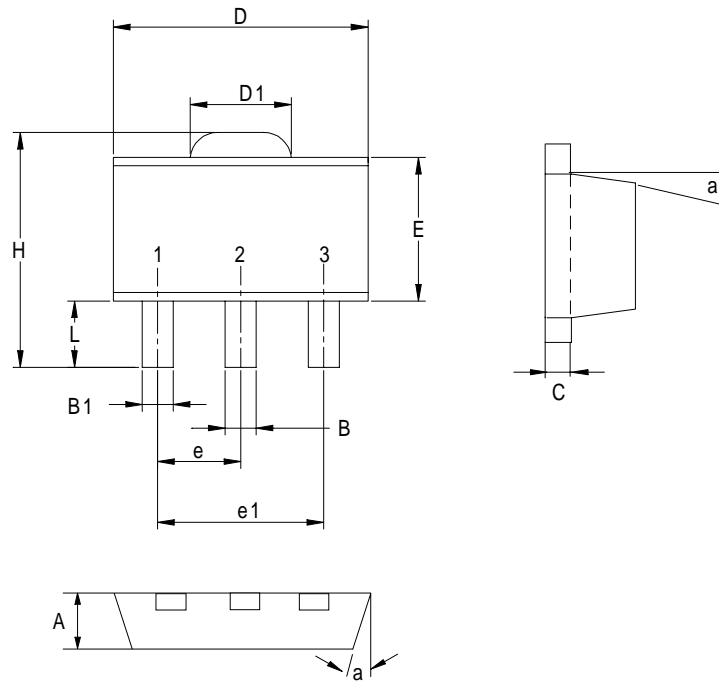

Dim	Millimeters		Inches	
	Min.	Max.	Min.	Max.
A	1.40	1.60	0.055	0.063
B	0.40	0.56	0.016	0.022
B1	0.35	0.48	0.014	0.019
C	0.35	0.44	0.014	0.017
D	4.40	4.60	0.173	0.181
D1	1.35	1.83	0.053	0.072
e	1.50 BSC		0.059 BSC	
e1	3.00 BSC		0.118 BSC	
E	2.29	2.60	0.090	0.102
H	3.75	4.25	0.148	0.167
L	0.80	1.20	0.031	0.047
α		10°		10°

Packaging Information

SOT-89-5

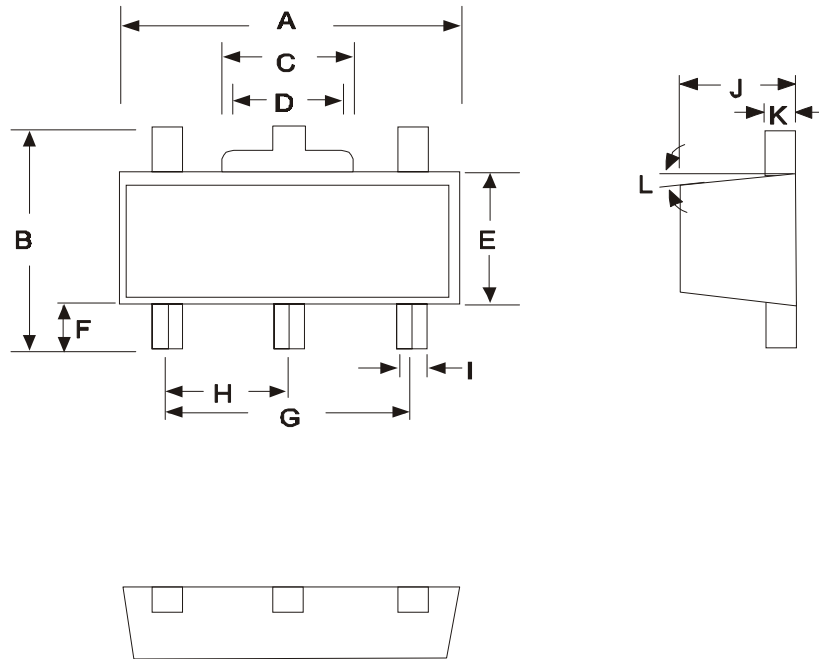

Dim	Millimeters		Inches	
	Min.	Max.	Min.	Max.
A	4.40	4.60	0.17	0.18
B	4.05	4.25	0.16	0.17
C	1.50	1.70	0.06	0.07
D	1.30	1.50	0.05	0.06
E	2.40	2.60	0.09	0.1
F	0.80	-	0.03	-
G	3.00 REF		0.12 REF	
H	1.50 REF		0.06 REF	
I	0.40	0.52	0.01	0.02
J	1.40	1.60	0.05	0.06
K	0.35	0.41	0.01	0.02
L	5 TYP		0.2 TYP	

Physical Specifications

Terminal Material	Solder-Plated Copper (Solder Material : 90/10 or 63/37 SnPb), 100%Sn
Lead Solderability	Meets EIA Specification RS186-91, ANSI/J-STD-002 Category 3.

Reflow Condition (IR/Convection or VPR Reflow)

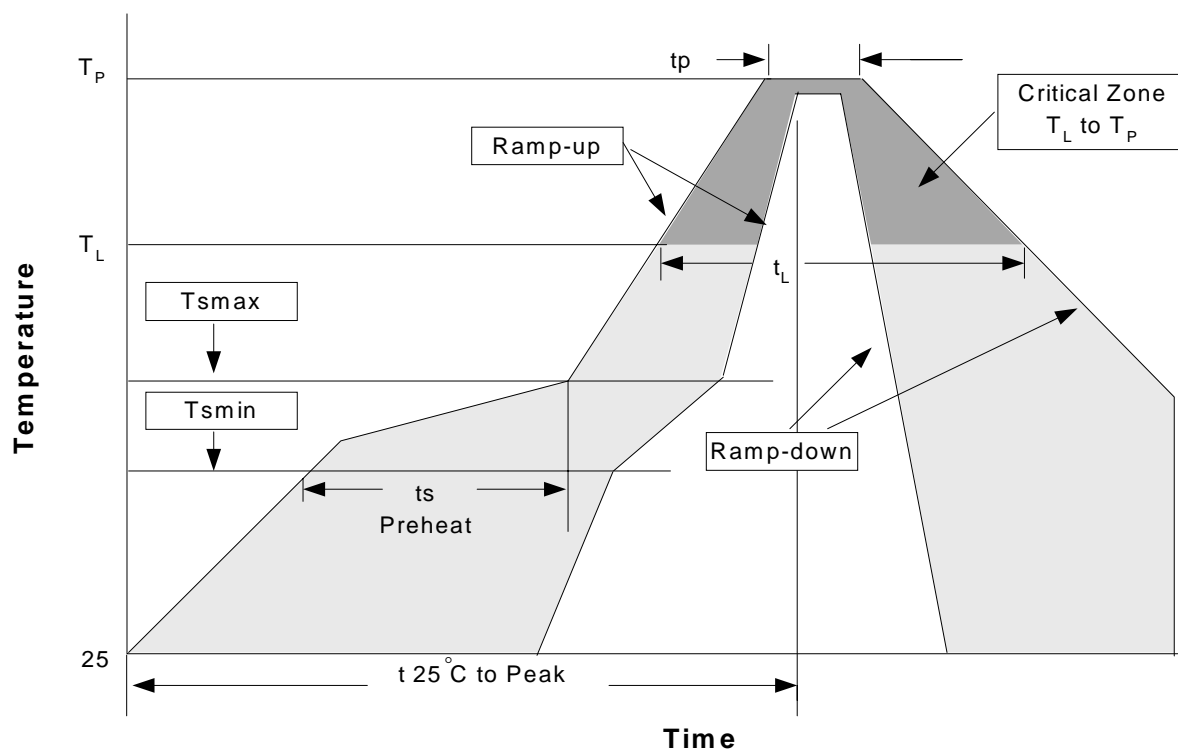

Classification Reflow Profiles

Profile Feature	Sn-Pb Eutectic Assembly		Pb-Free Assembly	
	Large Body	Small Body	Large Body	Small Body
Average ramp-up rate (T_L to T_P)	3°C/second max.		3°C/second max.	
Preheat				
- Temperature Min (T_{smin})	100°C		150°C	
- Temperature Mix (T_{smax})	150°C		200°C	
- Time (min to max)(t_s)	60-120 seconds		60-180 seconds	
T_{smax} to T_L				
- Ramp-up Rate			3°C/second max	
T_{smax} to T_L				
- Temperature(T_L)	183°C		217°C	
- Time (t_L)	60-150 seconds		60-150 seconds	
Peak Temperature(T_p)	225 +0/-5°C	240 +0/-5°C	245 +0/-5°C	250 +0/-5°C
Time within 5°C of actual Peak Temperature(t_p)	10-30 seconds	10-30 seconds	10-30 seconds	20-40 seconds
Ramp-down Rate	6°C/second max.		6°C/second max.	
Time 25°C to Peak Temperature	6 minutes max.		8 minutes max.	

Note: All temperatures refer to topside of the package. Measured on the body surface.

Reliability test program

Test item	Method	Description
SOLDERABILITY	MIL-STD-883D-2003	245°C , 5 SEC
HOLT	MIL-STD-883D-1005.7	1000 Hrs Bias @ 125 °C
PCT	JESD-22-B, A102	168 Hrs, 100 % RH , 121°C
TST	MIL-STD-883D-1011.9	-65°C ~ 150°C, 200 Cycles
ESD	MIL-STD-883D-3015.7	VHBM > 2KV, VMM > 200V
Latch-Up	JESD 78	10ms , I _{tr} > 100mA

Carrier Tape

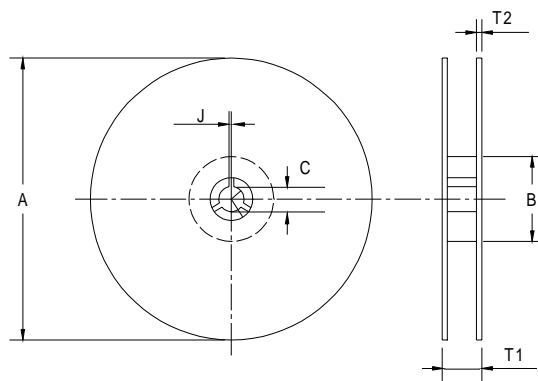
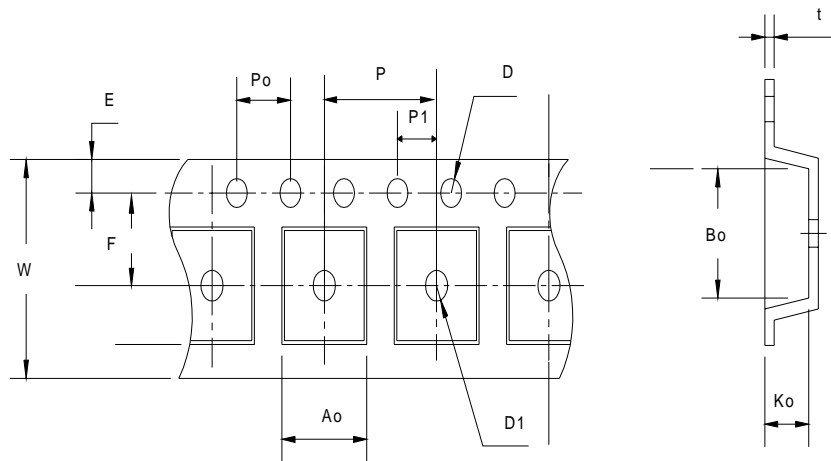

Reel Dimensions

Application	A	B	C	J	T1	T2	W	P	E
SOP- 8	330 ± 1	62 +1.5	12.75+ 0.15	2 ± 0.5	12.4 ± 0.2	2 ± 0.2	12± 0. 3	8± 0.1	1.75±0.1
	F	D	D1	Po	P1	Ao	Bo	Ko	t
	5.5 ± 1	1.55 +0.1	1.55+ 0.25	4.0 ± 0.1	2.0 ± 0.1	6.4 ± 0.1	5.2± 0. 1	2.1± 0.1	0.3±0.013
Application	A	B	C	J	T1	T2	W	P	E
SOT-89	178 ±1	70 ± 2	13.5 ± 0.15	3 ± 0.15	14 ± 2	1.3 ± 0.3	12 + 0.3 12 - 0.1	8 ± 0.1	1.75± 0.1
	F	D	D1	Po	P1	Ao	Bo	Ko	t
	5.5 ± 0.05	1.5 ± 0.1	1.5 ± 0.1	4.0 ± 0.1	2.0 ± 0.1	4.8 ± 0.1	4.5 ± 0.1	1.80 ± 0.1	0.3 ± 0.013
Application	A	B	C	J	T1	T2	W	P	E
SOT-23-5	178 ±1	72 ± 1.0	13.0 ± 0.2	2.5 ± 0.15	8.4 ± 2	1.5 ± 0.3	8.0+ 0.3 - 0.3	4 ± 0.1	1.75 ± 0.1
	F	D	D1	Po	P1	Ao	Bo	Ko	t
	3.5 ± 0.05	1.5 +0.1	1.5 +0.1	4.0 ± 0.1	2.0 ± 0.1	3.15 ± 0.1	3.2 ± 0.1	1.4 ± 0.1	0.2 ± 0.03

(mm)

Cover Tape Dimensions

Application	Carrier Width	Cover Tape Width	Devices Per Reel
SOP- 8	12	9.3	2500
SOT- 23	8	5.3	3000
SOT- 89	12	9.3	1000

Customer Service

Anpec Electronics Corp.

Head Office :

5F, No. 2 Li-Hsin Road, SBIP,

Hsin-Chu, Taiwan, R.O.C.

Tel : 886-3-5642000

Fax : 886-3-5642050

Taipei Branch :

7F, No. 137, Lane 235, Pac Chiao Rd.,

Hsin Tien City, Taipei Hsien, Taiwan, R. O. C.

Tel : 886-2-89191368

Fax : 886-2-89191369