



N-Channel Enhancement-Mode Vertical DMOS FETs

Features

- ▶ Free from secondary breakdown
- ▶ Low power drive requirement
- ▶ Ease of paralleling
- ▶ Low C_{iss} and fast switching speeds
- ▶ Excellent thermal stability
- ▶ Integral Source-Drain diode
- ▶ High input impedance and high gain
- ▶ Complementary N- and P-Channel devices

Applications

- ▶ Motor controls
- ▶ Converters
- ▶ Amplifiers
- ▶ Switches
- ▶ Power supply circuits
- ▶ Drivers (relays, hammers, solenoids, lamps, memories, displays, bipolar transistors, etc.)

General Description

The Supertex 2N7002 is an enhancement-mode (normally-off) transistor that utilizes a vertical DMOS structure and Supertex's well-proven silicon-gate manufacturing process. This combination produces a device with the power handling capabilities of bipolar transistors, and the high input impedance and positive temperature coefficient inherent in MOS devices. Characteristic of all MOS structures, this device is free from thermal runaway and thermally-induced secondary breakdown.

Supertex's vertical DMOS FETs are ideally suited to a wide range of switching and amplifying applications where very low threshold voltage, high breakdown voltage, high input impedance, low input capacitance, and fast switching speeds are desired.

Ordering Information

Device	Package	BV_{DSS}/BV_{DGS} (V)	$R_{DS(ON)}$ (max) (Ω)	$I_{D(ON)}$ (min) (A)
2N7002	TO-236AB (same as SOT-23)	60	7.5	0.5
2N7002-G				

-G indicates package is RoHS compliant ('Green')



Absolute Maximum Ratings

Parameter	Value
DRAIN to SOURCE voltage	BV_{DSS}
DRAIN to GATE voltage	BV_{DGS}
GATE to SOURCE voltage	$\pm 30V$
Operating and storage temperature	$-55^{\circ}C$ to $+150^{\circ}C$
Soldering temperature ¹	$+300^{\circ}C$

Absolute Maximum Ratings are those values beyond which damage to the device may occur. Functional operation under these conditions is not implied. Continuous operation of the device at the absolute rating level may affect device reliability. All voltages are referenced to device ground.

Notes:

1. Distance of 1.6mm from case for 10 seconds.

Pin Configuration

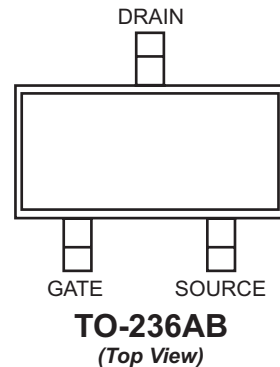

Product Marking



* = 2-week alpha date code

Electrical Characteristics ($T_A=25^\circ\text{C}$ unless otherwise specified)

Symbol	Parameter	Min	Typ	Max	Units	Conditions
BV_{DSS}	Drain-to-source breakdown voltage	60	-	-	V	$V_{GS} = 0V, I_D = 10\mu A$
$V_{GS(th)}$	Gate threshold voltage	1.0	-	2.5	V	$V_{GS} = V_{DS}, I_D = 250\mu A$
$\Delta V_{GS(th)}$	Change in $V_{GS(th)}$ with temperature	-	-	-5.5	mV/°C	$V_{GS} = V_{DS}, I_D = 250\mu A$
I_{GSS}	Gate body leakage current	-	-	± 100	nA	$V_{GS} = \pm 20V, V_{DS} = 0V$
I_{DSS}	Zero gate voltage drain current	-	-	1.0	μA	$V_{GS} = 0V, V_{DS} = \text{Max rating}$
		-	-	500		$V_{GS} = 0V, V_{DS} = 0.8\text{Max rating}, T_A = 125^\circ\text{C}$
$I_{D(ON)}$	ON-state drain current	500	-	-	mA	$V_{GS} = 10V, V_{DS} = 25V$
$R_{DS(ON)}$	Static drain-to-source ON-state resistance	-	-	7.5	Ω	$V_{GS} = 5.0V, I_D = 50mA$
		-	-	7.5		$V_{GS} = 10V, I_D = 500mA$
$\Delta R_{DS(ON)}$	Change in $R_{DS(ON)}$ with temperature	-	-	1.0	%/°C	$V_{GS} = 10V, I_D = 500mA$
G_{FS}	Forward transconductance	80	-	-	mmho	$V_{DS} = 25V, I_D = 500mA$
C_{ISS}	Input capacitance	-	-	50	pF	$V_{GS} = 0V, V_{DS} = 25V, f = 1.0MHz$
C_{OSS}	Common source output capacitance	-	-	25		
C_{RSS}	Reverse transfer capacitance	-	-	5		
$t_{(ON)}$	Turn-ON time	-	-	20	ns	$V_{DD} = 30V, I_D = 200mA, R_{GEN} = 25\Omega$
$t_{(OFF)}$	Turn-OFF time	-	-	20		
V_{SD}	Diode forward voltage drop	-	1.2	-	V	$V_{GS} = 0V, I_{SD} = 200mA$
t_{rr}	Reverse recovery time	-	400	-	ns	$V_{GS} = 0V, I_{SD} = 800mA$

Notes:

- All D.C. parameters 100% tested at 25°C unless otherwise stated. (Pulse test: $300\mu s$ pulse, 2% duty cycle.)
- All A.C. parameters sample tested.

Thermal Characteristics

Device	Package	I_D (continuous)* (mA)	I_D (pulsed) (mA)	Power Dissipation @ $T_A = 25^\circ\text{C}$ (W)	θ_{jc} (°C/W)	θ_{ja} (°C/W)	I_{DR}^* (mA)	I_{DRM} (mA)
2N7002	TO-236AB	115	800	0.36	200	350	115	800

Notes:

- * I_D (continuous) is limited by max rated T_J .

Switching Waveforms and Test Circuit

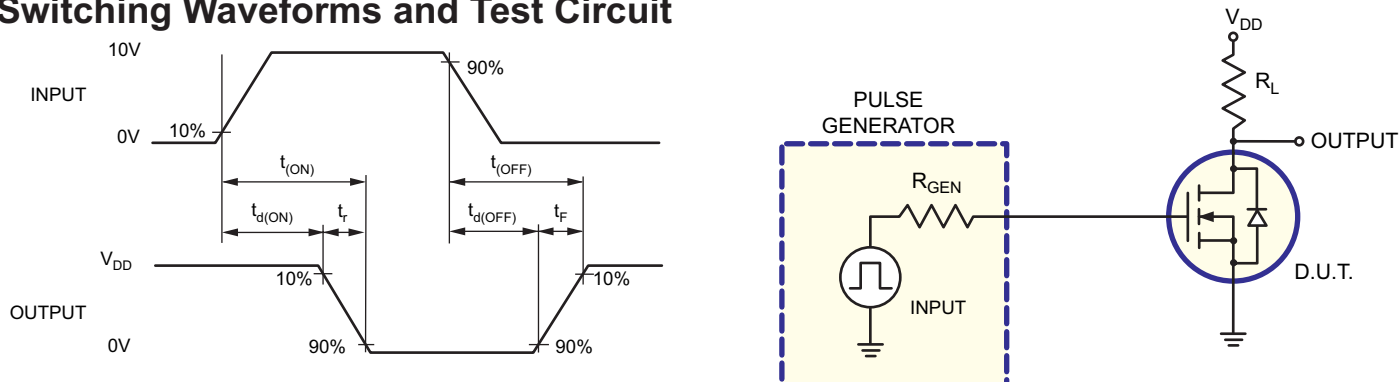

Typical Performance Curves

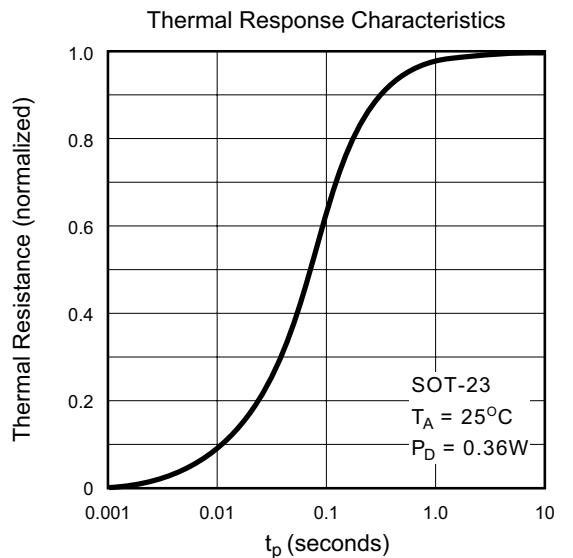
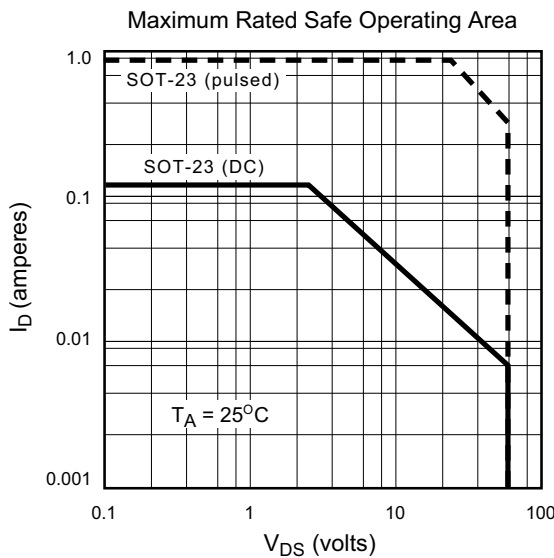
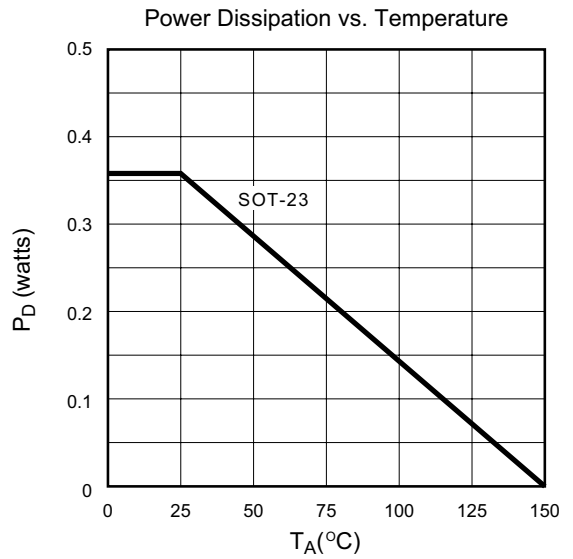
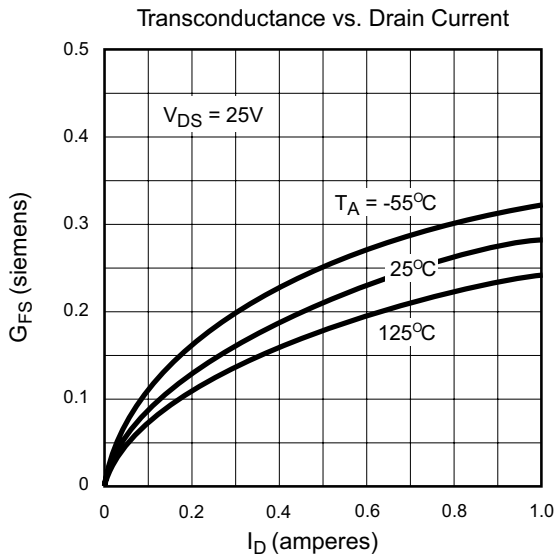
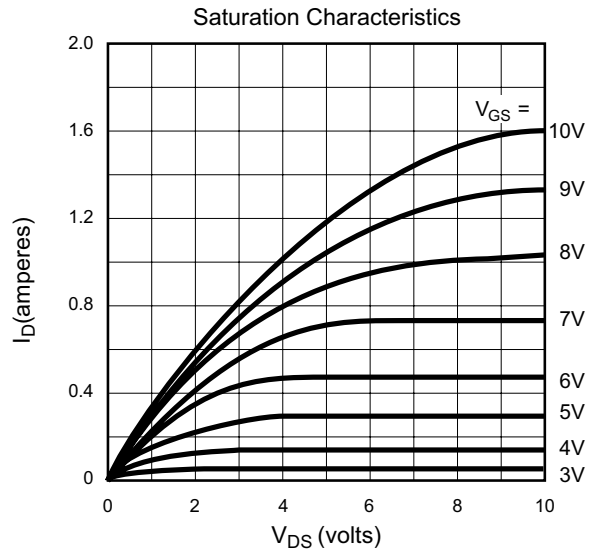
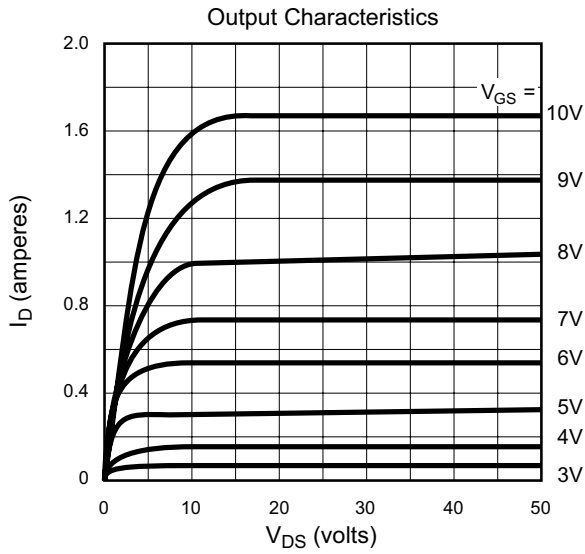

Typical Performance Curves (cont.)

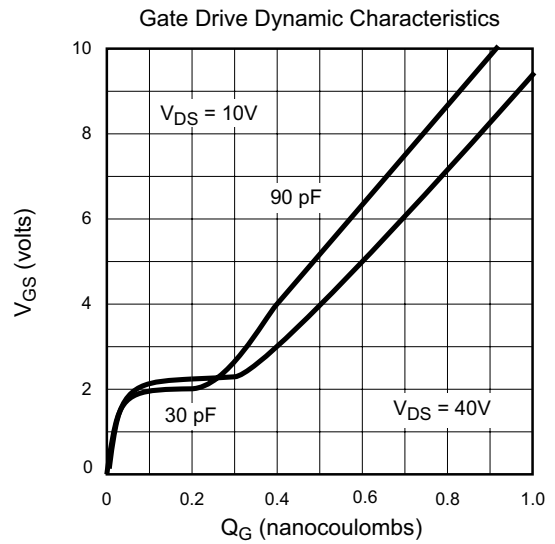
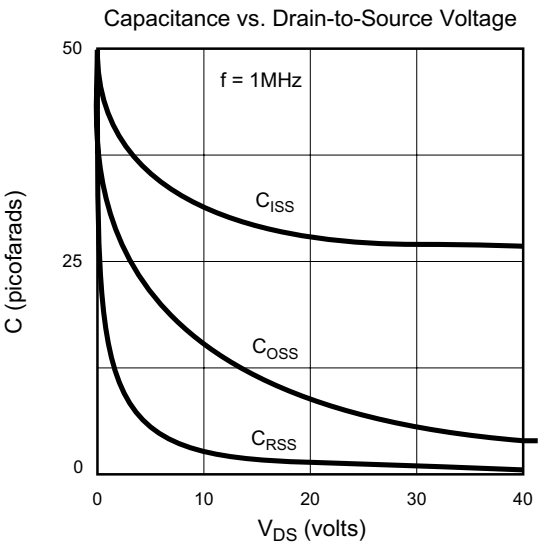
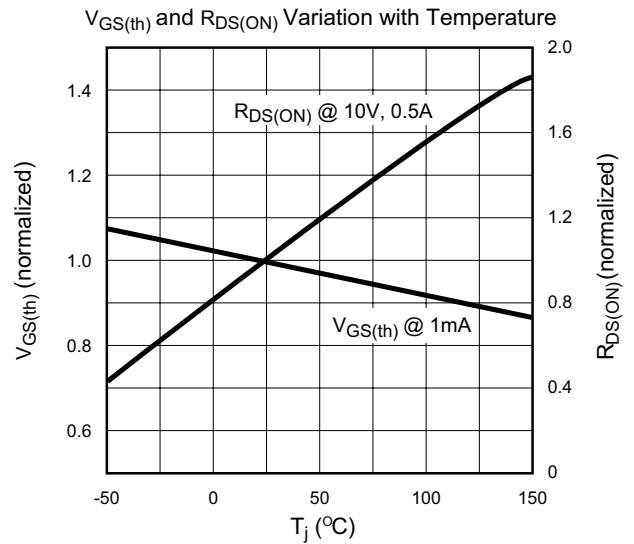
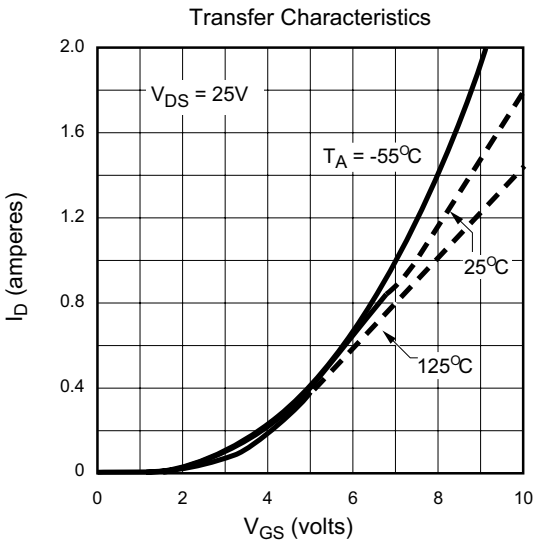
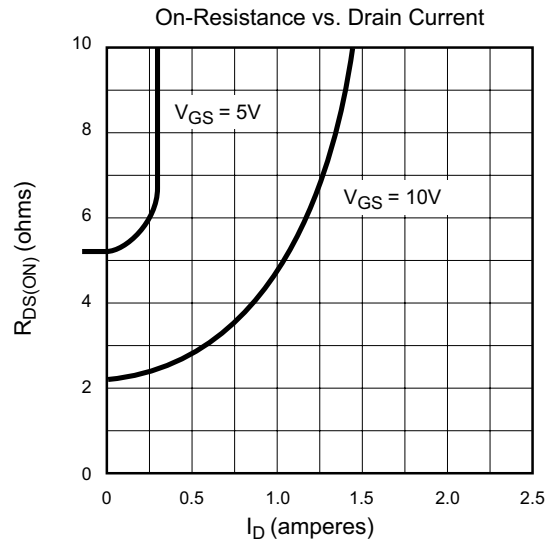
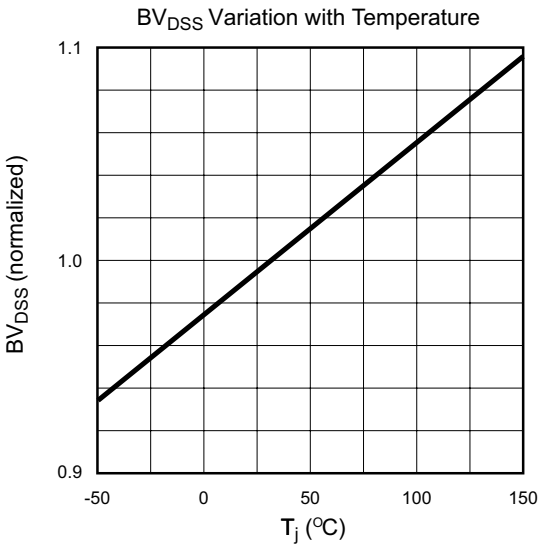

TO-236AB Package Outline

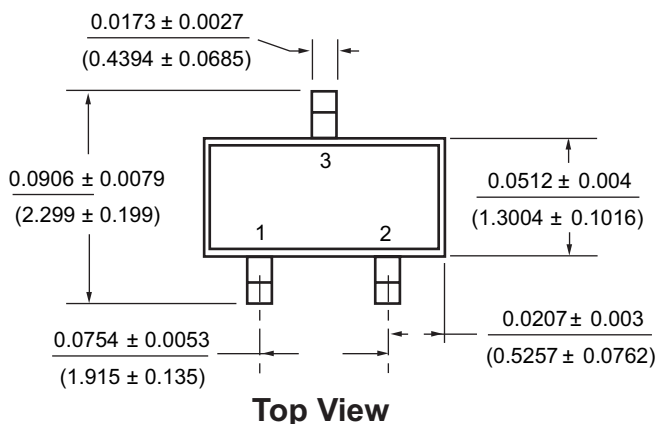

Measurement Legend = $\frac{\text{Dimensions in Inches}}{\text{(Dimensions in Millimeters)}}$

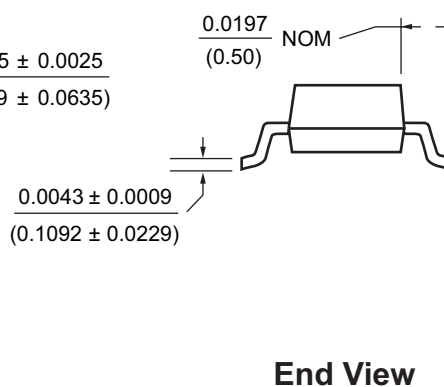
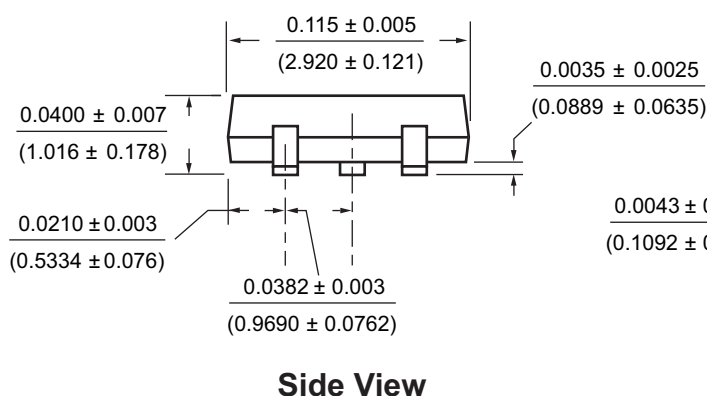

(The package drawing(s) in this data sheet may not reflect the most current specifications. For the latest package outline information go to <http://www.supertex.com/packaging.html>.)

Supertex inc. does not recommend the use of its products in life support applications, and will not knowingly sell its products for use in such applications, unless it receives an adequate "product liability indemnification insurance agreement". **Supertex** does not assume responsibility for use of devices described and limits its liability to the replacement of the devices determined defective due to workmanship. No responsibility is assumed for possible omissions or inaccuracies. Circuitry and specifications are subject to change without notice. For the latest product specifications, refer to the **Supertex** website: <http://www.supertex.com>.