

**Functional Description (continued)**
**Single Write Accesses Initiated by ADSP**

This access is initiated when the following conditions are satisfied at clock rise: (1)  $\overline{CS}$  is LOW and (2) ADSP is LOW. ADSP-triggered write cycles are completed in two clock periods. The address at  $A_0$  through  $A_{15}$  is loaded into the address register and address advancement logic and delivered to the RAM core. The write signal is ignored in this cycle because the cache tag or other external logic uses this clock period to perform address comparisons or protection checks. If the write is allowed to proceed, the write input to the CY7C1031 and CY7C1032 will be pulled LOW before the next clock rise. ADSP is ignored if  $\overline{CS}$  is HIGH.

If  $\overline{WH}$ ,  $\overline{WL}$ , or both are LOW at the next clock rise, information presented at  $DQ_0 - DQ_{15}$  and  $DP_0 - DP_1$  will be written into the location specified by the address advancement logic.  $\overline{WL}$  controls the writing of  $DQ_0 - DQ_7$  and  $DP_0$  while  $\overline{WH}$  controls the writing of  $DQ_8 - DQ_{15}$  and  $DP_1$ . Because the CY7C1031 and CY7C1032 are common-I/O devices, the output enable signal ( $\overline{OE}$ ) must be deasserted before data from the CPU is delivered to  $DQ_0 - DQ_{15}$  and  $DP_0 - DP_1$ . As a safety precaution, the appropriate data lines are three-stated in the cycle where  $\overline{WH}$ ,  $\overline{WL}$ , or both are sampled LOW, regardless of the state of the  $\overline{OE}$  input.

**Single Write Accesses Initiated by ADSC**

This write access is initiated when the following conditions are satisfied at rising edge of the clock: (1)  $\overline{CS}$  is LOW, (2) ADSC is LOW, and (3)  $\overline{WH}$  or  $\overline{WL}$  are LOW. ADSC triggered accesses are completed in a single clock cycle.

The address at  $A_0$  through  $A_{15}$  is loaded into the address register and address advancement logic and delivered to the RAM core. Information presented at  $DQ_0 - DQ_{15}$  and  $DP_0 - DP_1$  will be written into the location specified by the address advancement logic. Since the CY7C1031 and the CY7C1032 are common-I/O devices, the output enable signal ( $\overline{OE}$ ) must be deasserted before data from the cache controller is delivered to the data and parity lines. As a safety precaution, the appropriate data and parity lines are three-stated in the cycle where  $\overline{WH}$  and  $\overline{WL}$  are sampled LOW regardless of the state of the  $\overline{OE}$  input.

**Single Read Accesses**

A single read access is initiated when the following conditions are satisfied at clock rise: (1)  $\overline{CS}$  is LOW, (2) ADSP or ADSC is LOW,

and (3)  $\overline{WH}$  and  $\overline{WL}$  are HIGH. The address at  $A_0$  through  $A_{15}$  is stored into the address advancement logic and delivered to the RAM core. If the output enable ( $\overline{OE}$ ) signal is asserted (LOW), data will be available at the data outputs a maximum of 8.5 ns after clock rise. ADSP is ignored if  $\overline{CS}$  is HIGH.

**Burst Sequences**

The CY7C1031 provides a 2-bit wraparound counter, fed by pins  $A_0 - A_1$ , that implements the Intel 80486 and Pentium processor's address burst sequence (see Table 1). Note that the burst sequence depends on the first burst address.

**Table 1. Counter Implementation for the Intel Pentium/80486 Processor's Sequence**

First Address	Second Address	Third Address	Fourth Address
$A_X + 1, A_X$	$A_X + 1, A_X$	$A_X + 1, A_X$	$A_X + 1, A_X$
00	01	10	11
01	00	11	10
10	11	00	01
11	10	01	00

The CY7C1032 provides a two-bit wraparound counter, fed by pins  $A_0 - A_1$ , that implements a linear address burst sequence (see Table 2).

**Table 2. Counter Implementation for a Linear Sequence**

First Address	Second Address	Third Address	Fourth Address
$A_X + 1, A_X$	$A_X + 1, A_X$	$A_X + 1, A_X$	$A_X + 1, A_X$
00	01	10	11
01	10	11	00
10	11	00	01
11	00	01	10

**Application Example**

Figure 1 shows a 512-Kbyte secondary cache for the Pentium microprocessor using four CY7C1031 cache RAMs.

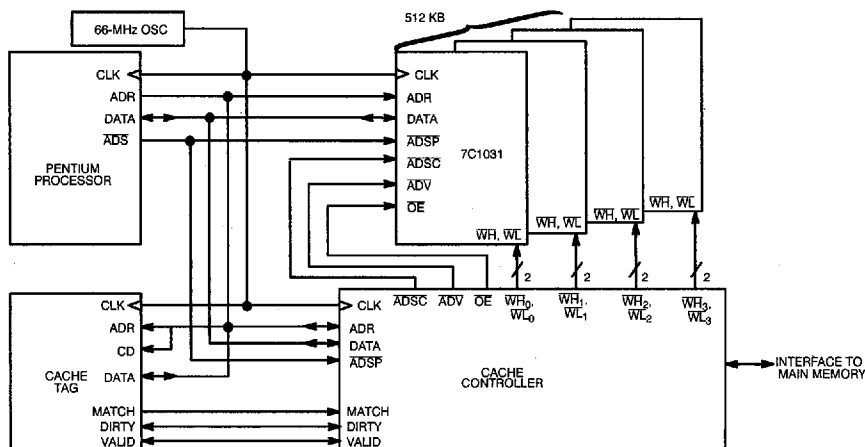
**Figure 1. Cache Using Four CY7C1031s**

**Pin Definitions**

Signal Name	Type	# of Pins	Description
VCC	Input	1	+5V Power
VCCO	Input	4	+5V or 3.3V (Outputs)
GND	Input	1	Ground
VSSQ	Input	4	Ground (Outputs)
CLK	Input	1	Clock
A <sub>15</sub> - A <sub>0</sub>	Input	16	Address
ADSP	Input	1	Address Strobe from Processor
ADSC	Input	1	Address Strobe from Cache Controller
WH	Input	1	Write Enable - High Byte
WL	Input	1	Write Enable - Low Byte
ADV	Input	1	Advance
OE	Input	1	Output Enable
CS	Input	1	Chip Select
DQ <sub>15</sub> -DQ <sub>0</sub>	Input/Output	16	Regular Data
DP <sub>1</sub> -DP <sub>0</sub>	Input/Output	2	Parity Data

**Pin Descriptions**

Signal Name	I/O	Description
<b>Input Signals</b>		
CLK	I	Clock signal. It is used to capture the address, the data to be written, and the following control signals: ADSP, ADSC, CS, WH, WL, and ADV. It is also used to advance the on-chip auto-address-increment logic (when the appropriate control signals have been set).
A <sub>15</sub> -A <sub>0</sub>	I	Sixteen address lines used to select one of 64K locations. They are captured in an on-chip register on the rising edge of CLK if ADSP or ADSC is LOW. The rising edge of the clock also loads the lower two address lines, A <sub>1</sub> - A <sub>0</sub> , into the on-chip auto-address-increment logic if ADSP or ADSC is LOW.
ADSP	I	Address strobe from processor. This signal is sampled at the rising edge of CLK. When this input and/or ADSC is asserted, A <sub>0</sub> -A <sub>15</sub> will be captured in the on-chip address register. It also allows the lower two address bits to be loaded into the on-chip auto-address-increment logic. If both ADSP and ADSC are asserted at the rising edge of CLK, only ADSP will be recognized. The ADSP input should be connected to the ADS output of the processor. ADSP is ignored when CS is HIGH.
ADSC	I	Address strobe from cache controller. This signal is sampled at the rising edge of CLK. When this input and/or ADSP is asserted, A <sub>0</sub> -A <sub>15</sub> will be captured in the on-chip address register. It also allows the lower two address bits to be loaded into the on-chip auto-address-increment logic. The ADSC input should <i>not</i> be connected to the ADS output of the processor.

Signal Name	I/O	Description
WH	I	Write signal for the high-order half of the RAM array. This signal is sampled by the rising edge of CLK. If WH is sampled as LOW, i.e., asserted, the control logic will perform a self-timed write of DQ <sub>15</sub> - DQ <sub>8</sub> and DP <sub>1</sub> from the on-chip data register into the selected RAM location. There is one exception to this. If ADSP, WH, and CS are asserted (LOW) at the rising edge of CLK, the write signal, WH, is ignored. Note that ADSP has no effect on WH if CS is HIGH.
WL	I	Write signal for the low-order half of the RAM array. This signal is sampled by the rising edge of CLK. If WL is sampled as LOW, i.e., asserted, the control logic will perform a self-timed write of DQ <sub>7</sub> - DQ <sub>0</sub> and DP <sub>0</sub> from the on-chip data register into the selected RAM location. There is one exception to this. If ADSP, WL, and CS are asserted (LOW) at the rising edge of CLK, the write signal, WL, is ignored. Note that ADSP has no effect on WL if CS is HIGH.
ADV	I	Advance. This signal is sampled by the rising edge of CLK. When it is asserted, it automatically increments the 2-bit on-chip auto-address-increment counter. In the CY7C1032, the address will be incremented linearly. In the CY7C1031, the address will be incremented according to the Pentium/486 burst sequence. This signal is ignored if ADSP or ADSC is asserted concurrently with CS. Note that ADSP has no effect on ADV if CS is HIGH.
CS	I	Chip select. This signal is sampled by the rising edge of CLK. If CS is HIGH and ADSC is LOW, the SRAM is deselected. If CS is LOW and ADSC or ADSP is LOW, a new address is captured by the address register. If CS is HIGH, ADSP is ignored.

**Pin Descriptions (continued)**

Signal Name	I/O	Description
$\overline{OE}$	I	Output enable. This signal is an asynchronous input that controls the direction of the data I/O pins. If $\overline{OE}$ is asserted (LOW), the data pins are outputs, and the SRAM can be read (as long as $\overline{CS}$ was asserted when it was sampled at the beginning of the cycle). If $\overline{OE}$ is deasserted (HIGH), the data I/O pins will be three-stated, functioning as inputs, and the SRAM can be written.

Signal Name	I/O	Description
$DP_1$ - $DP_0$	I/O	Two bidirectional data I/O lines. These operate in exactly the same manner as $DQ_{15}$ - $DQ_0$ , but are named differently because their primary purpose is to store parity bits, while the $DQ$ s' primary purpose is to store ordinary data bits. $DP_1$ is an input to and an output from the high-order half of the RAM array, while $DP_0$ is an input to and an output from the lower-order half of the RAM array.

**Bidirectional Signals**

$DQ_{15}$ - $DQ_0$	I/O	Sixteen bidirectional data I/O lines. $DQ_{15}$ - $DQ_8$ are inputs to and outputs from the high-order half of the RAM array, while $DQ_7$ - $DQ_0$ are inputs to and outputs from the low-order half of the RAM array. As inputs, they feed into an on-chip data register that is triggered by the rising edge of CLK. As outputs, they carry the data read from the selected location in the RAM array. The direction of the data pins is controlled by $\overline{OE}$ : when $\overline{OE}$ is high, the data pins are three-stated and can be used as inputs; when $\overline{OE}$ is low, the data pins are driven by the output buffers and are outputs. $DQ_{15}$ - $DQ_8$ and $DQ_7$ - $DQ_0$ are also three-stated when $\overline{WH}$ and $\overline{WL}$ , respectively, is sampled LOW at clock rise.
--------------------	-----	--

**Maximum Ratings**

(Above which the useful life may be impaired. For user guidelines, not tested.)

Storage Temperature	-65°C to +150°C
Ambient Temperature with Power Applied	-55°C to +125°C
Supply Voltage on $V_{CC}$ Relative to GND	-0.5V to +7.0V
DC Voltage Applied to Outputs in High Z State <sup>[2]</sup>	-0.5V to $V_{CC} + 0.5V$
DC Input Voltage <sup>[2]</sup>	-0.5V to $V_{CC} + 0.5V$
Current into Outputs (LOW)	20 mA

Static Discharge Voltage ..... >2001V  
(per MIL-STD-883, Method 3015)

Latch-Up Current ..... >200 mA

**Operating Range**

Range	Ambient Temperature <sup>[3]</sup>	$V_{CC}$	$V_{CCQ}$
Com <sup>1</sup>	0°C to +70°C	5V ± 5%	3.0V to $V_{CC}$
Mil	-55°C to +125°C	5V ± 5%	5V ± 5%

**Electrical Characteristics Over the Operating Range<sup>[4]</sup>**

Parameter	Description	Test Conditions	7C1031-7 7C1032-7		7C1031-8 7C1032-8		7C1031-10 7C1032-10		7C1031-12 7C1032-12		Unit
			Min.	Max.	Min.	Max.	Min.	Max.	Min.	Max.	
$V_{OH}$	Output HIGH Voltage	$V_{CC} = \text{Min.}, I_{OH} = -4.0 \text{ mA}$	2.4	$V_{CCQ}$	2.4	$V_{CCQ}$	2.4	$V_{CCQ}$	2.4	$V_{CCQ}$	V
$V_{OL}$	Output LOW Voltage	$V_{CC} = \text{Min.}, I_{OL} = 8.0 \text{ mA}$		0.4		0.4		0.4		0.4	V
$V_{IH}$	Input HIGH Voltage		2.2	$V_{CC} + 0.3V$	2.2	$V_{CC} + 0.3V$	2.2	$V_{CC} + 0.3V$	2.2	$V_{CC} + 0.3V$	V
$V_{IL}$	Input LOW Voltage <sup>[2]</sup>		-0.3	0.8	-0.3	0.8	-0.3	0.8	-0.3	0.8	V
$I_X$	Input Load Current	$GND \leq V_I \leq V_{CC}$	-1	1	-1	1	-1	1	-1	1	μA
$I_{OZ}$	Output Leakage Current	$GND \leq V_I \leq V_{CC}, \text{ Output Disabled}$	-5	5	-5	5	-5	5	-5	5	μA

Shaded area contains preliminary information.

**Notes:**

- Minimum voltage equals -2.0V for pulse durations of less than 20 ns.
- See the last page for Group A subgroup testing information.
- $T_A$  is the "instant on" case temperature.

**Electrical Characteristics (continued)**

Parameter	Description	Test Conditions	7C1031-7 7C1032-7		7C1031-8 7C1032-8		7C1031-10 7C1032-10		7C1031-12 7C1032-12		Unit	
			Min.	Max.	Min.	Max.	Min.	Max.	Min.	Max.		
$I_{OS}$	Output Short Circuit Current <sup>[5]</sup>	$V_{CC} = \text{Max.}, V_{OUT} = \text{GND}$		-300		-300		-300		-300	mA	
$I_{CC}$	$V_{CC}$ Operating Supply Current	$V_{CC} = \text{Max.}, I_{out} = 0\text{mA}, f = f_{MAX} = 1/t_{CYC}$	Com <sup>1</sup>		300		280		280		230	mA
			Mil								250	
$I_{SB1}$	Automatic CE Power-Down Current - TTL Inputs	Max. $V_{CC}, \overline{CS} \geq V_{IH}, V_{IN} \geq V_{IH}$ or $V_{IN} \leq V_{IL}, f = f_{MAX}$	Com <sup>1</sup>		90		80		80		60	mA
			Mil								70	
$I_{SB2}$	Automatic CE Power-Down Current - CMOS Inputs	Max. $V_{CC}, \overline{CS} \geq V_{CC} - 0.3\text{V}, V_{IN} \geq V_{CC} - 0.3\text{V}$ or $V_{IN} \leq 0.3\text{V}, f = 0$ <sup>[6]</sup>	Com <sup>1</sup>		30		30		30		30	mA
			Mil								50	

Shaded areas contain preliminary information

**Capacitance<sup>[7]</sup>**

Parameter	Description	Test Conditions	Max.	Unit	
$C_{IN}$ : Addresses	Input Capacitance	$T_A = 25^\circ\text{C}, f = 1\text{MHz}, V_{CC} = 5.0\text{V}$	Com <sup>1</sup>	4.5	pF
			Mil	6	
$C_{IN}$ : Other Inputs			Com <sup>1</sup>	5	pF
			Mil	8	
$C_{OUT}$	Output Capacitance		Com <sup>1</sup>	8	pF
			Mil	10	

Shaded areas contain advanced information

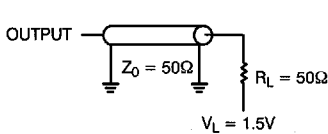
**AC Test Loads and Waveforms**

(a) Normal Load

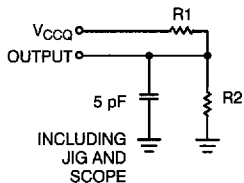
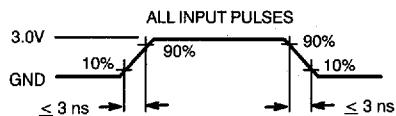
 (b)<sup>[8]</sup> High-Z Load

1031-4

**Notes:**

- Not more than one output should be shorted at one time. Duration of the short circuit should not exceed 30 seconds.
- Inputs are disabled, clock is allowed to run at speed.
- Tested initially and after any design or process changes that may affect these parameters.
- Resistor values for  $V_{CCQ} = 5\text{V}$  are:  $R1 = 1179\Omega$  and  $R2 = 868\Omega$ . Resistor values for  $V_{CCQ} = 3.3\text{V}$  are:  $R1 = 317\Omega$  and  $R2 = 348\Omega$ .

**Switching Characteristics Over the Operating Range<sup>[9]</sup>**

Parameter	Description	7C1031-7 7C1032-7		7C1031-8 7C1032-8		7C1031-10 7C1032-10		7C1031-12 7C1032-12		Unit
		Min.	Max.	Min.	Max.	Min.	Max.	Min.	Max.	
t <sub>CYC</sub>	Clock Cycle Time	13.3		15		15		20		ns
t <sub>CH</sub>	Clock HIGH	5		5		6		8		ns
t <sub>CL</sub>	Clock LOW	5		5		6		8		ns
t <sub>AS</sub>	Address Set-Up Before CLK Rise	2.5		2.5		2.5		2.5		ns
t <sub>AH</sub>	Address Hold After CLK Rise	0.5		0.5		0.5		0.5		ns
t <sub>CDV</sub>	Data Output Valid After CLK Rise		7		8.5		10		12	ns
t <sub>DOH</sub>	Data Output Hold After CLK Rise	2		3		3		3		ns
t <sub>ADS</sub>	ADSP, ADSC Set-Up Before CLK Rise	2.5		2.5		2.5		2.5		ns
t <sub>ADSH</sub>	ADSP, ADSC Hold After CLK Rise	0.5		0.5		0.5		0.5		ns
t <sub>WES</sub>	$\overline{WH}$ , $\overline{WL}$ Set-Up Before CLK Rise	2.5		2.5		2.5		2.5		ns
t <sub>WEH</sub>	$\overline{WH}$ , $\overline{WL}$ Hold After CLK Rise	0.5		0.5		0.5		0.5		ns
t <sub>ADVS</sub>	$\overline{ADV}$ Set-Up Before CLK Rise	2.5		2.5		2.5		2.5		ns
t <sub>ADVH</sub>	$\overline{ADV}$ Hold After CLK Rise	0.5		0.5		0.5		0.5		ns
t <sub>DS</sub>	Data Input Set-Up Before CLK Rise	2.5		2.5		2.5		2.5		ns
t <sub>DH</sub>	Data Input Hold After CLK Rise	0.5		0.5		0.5		0.5		ns
t <sub>CSS</sub>	Chip Select Set-Up	2.5		2.5		2.5		2.5		ns
t <sub>CSH</sub>	Chip Select Hold After CLK Rise	0.5		0.5		0.5		0.5		ns
t <sub>CSOZ</sub>	Chip Select Sampled to Output High Z <sup>[10]</sup>	2	6	2	6	2	6	2	7	ns
t <sub>EOZ</sub>	$\overline{OE}$ HIGH to Output High Z <sup>[10]</sup>	2	6	2	6	2	6	2	7	ns
t <sub>EOV</sub>	$\overline{OE}$ LOW to Output Valid		5		5		5		6	ns
t <sub>WEOZ</sub>	$\overline{WH}$ or $\overline{WL}$ Sampled LOW to Output High Z <sup>[10,11]</sup>		5		5		6		7	ns
t <sub>WEOV</sub>	$\overline{WH}$ or $\overline{WL}$ Sampled HIGH to Output Valid <sup>[11]</sup>		7		8.5		10		12	ns

Shaded areas contain preliminary information

**Notes:**

- Unless otherwise noted, test conditions assume signal transition time of 3 ns or less, timing reference levels of 1.5V, input pulse levels of 0 to 3.0V, and output loading of the specified  $I_{OL}/I_{OH}$  and load capacitance. Shown in (a) and (b) as AC test loads.
- t<sub>CSOZ</sub>, t<sub>EOZ</sub>, and t<sub>WEOZ</sub> are specified with a load capacitance of 5 pF as in part (b) of AC Test Loads. Transition is measured  $\pm$  500 mV from steady-state voltage.
- At any given voltage and temperature, t<sub>WEOZ min.</sub> is less than t<sub>WEOV min.</sub>

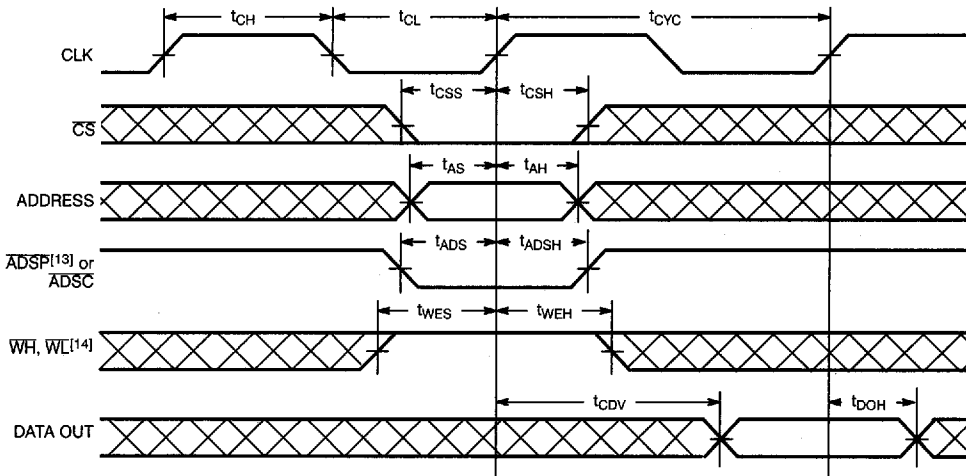
**Switching Waveforms**
**Single Read<sup>[12]</sup>**

1031-6

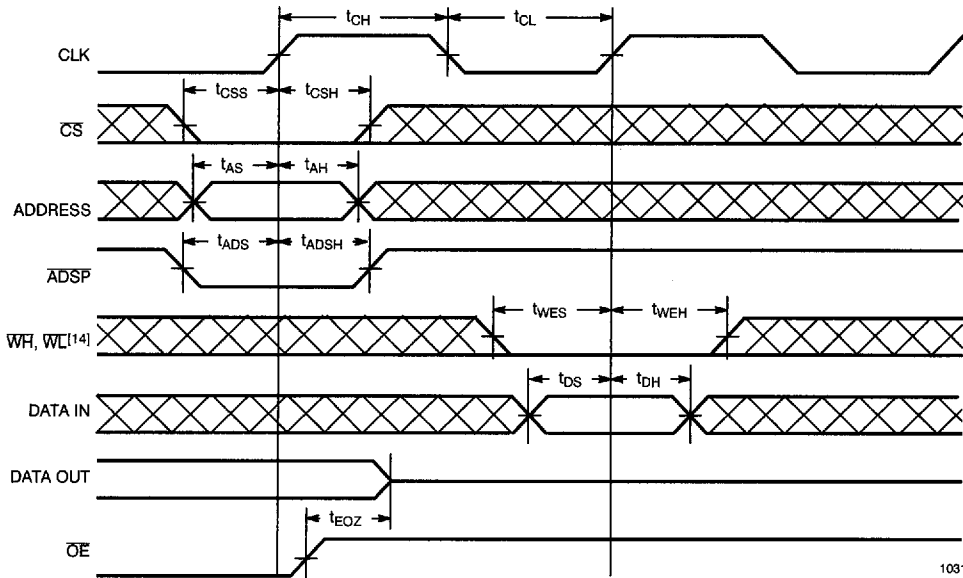
**Single Write Timing: Write Initiated by ADSP**

1031-5

**Notes:**

12. OE is LOW throughout this operation.

13. If ADSP is asserted while CS is HIGH, ADSP will be ignored.

14. ADSP has no effect on ADV, WL, and WH if CS is HIGH.

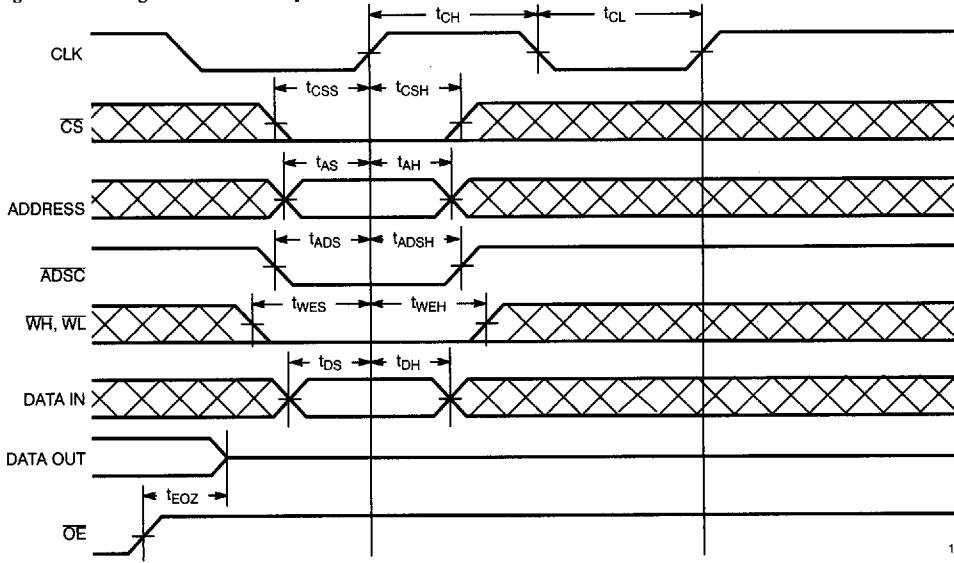
**Switching Waveforms (continued)**
**Single Write Timing: Write Initiated by ADSC**

1031-7

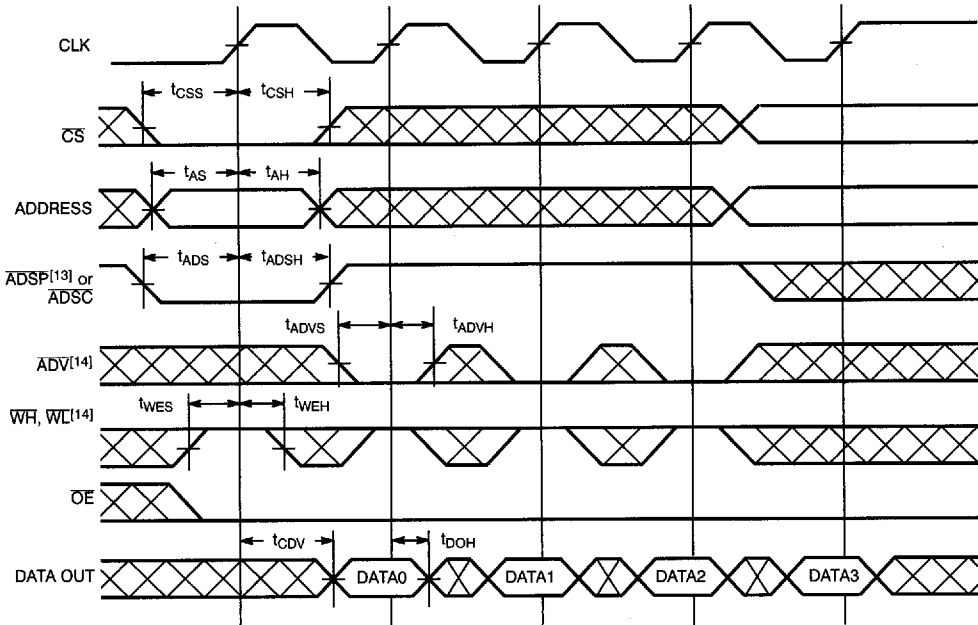
**Burst Read Sequence with Four Accesses**

1031-8

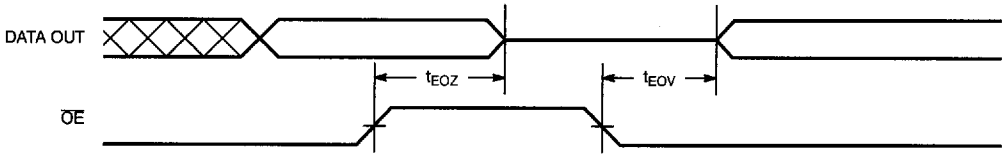
**Switching Waveforms (continued)**
**Output (Controlled by  $\overline{OE}$ )**

1031-9

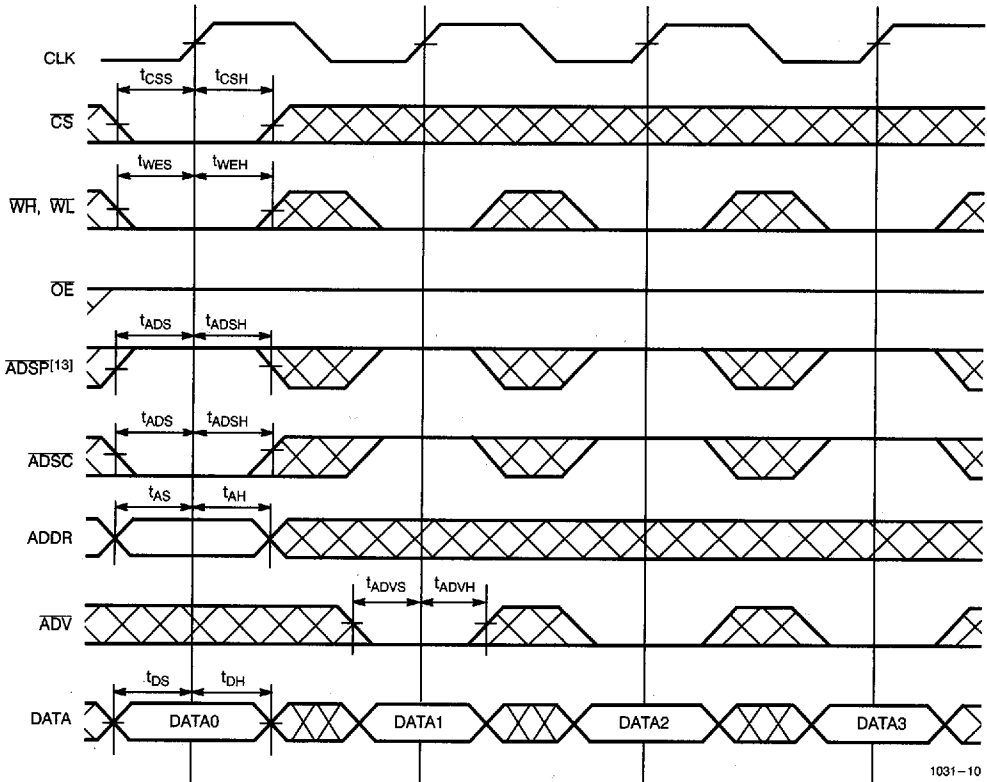
**Write Burst Timing: Write Initiated by  $\overline{ADSC}$** 

1031-10

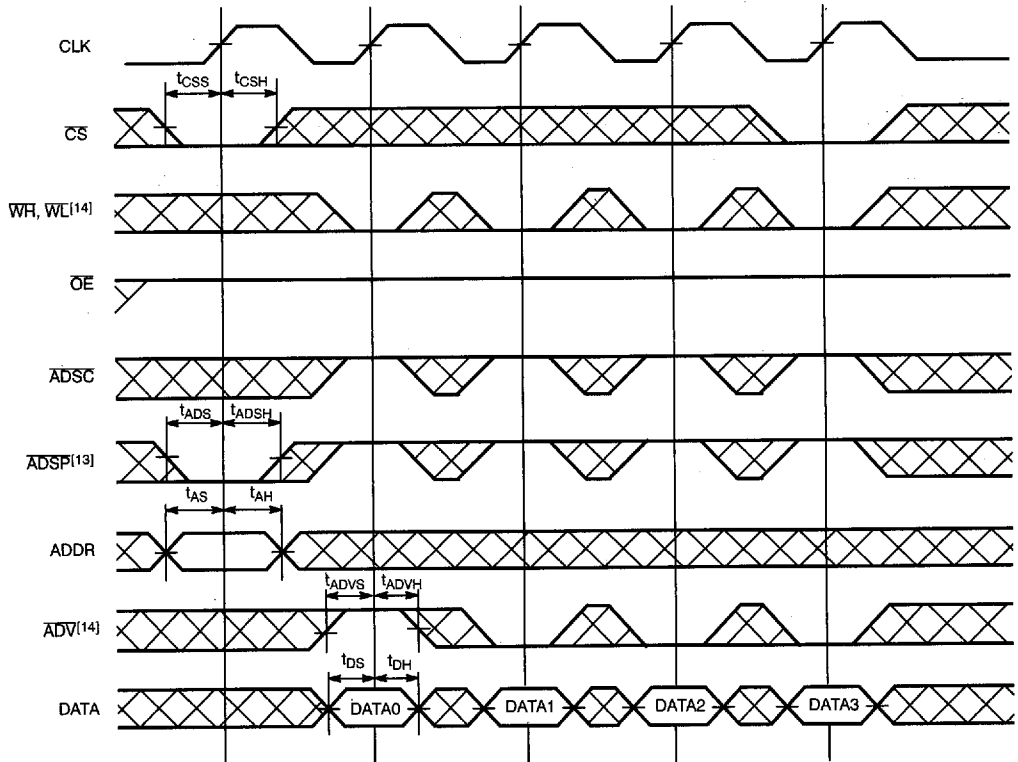

**Switching Waveforms (continued)**
**Write Burst Timing: Write Initiated by  $\overline{\text{ADSP}}$** 

1031-11

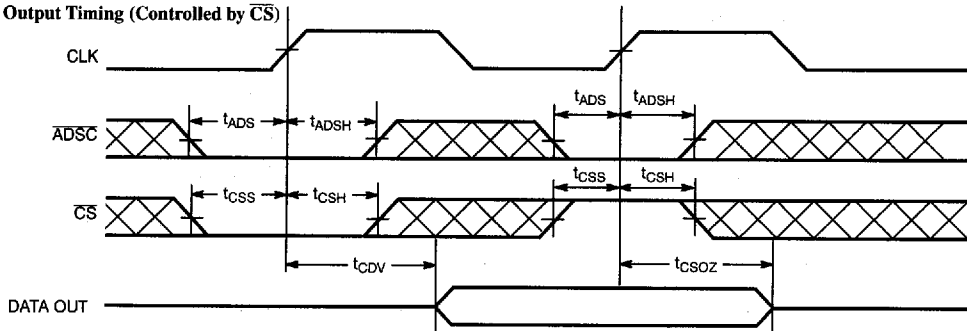
**Switching Waveforms (continued)**
**Output Timing (Controlled by  $\overline{CS}$ )**

1031-12

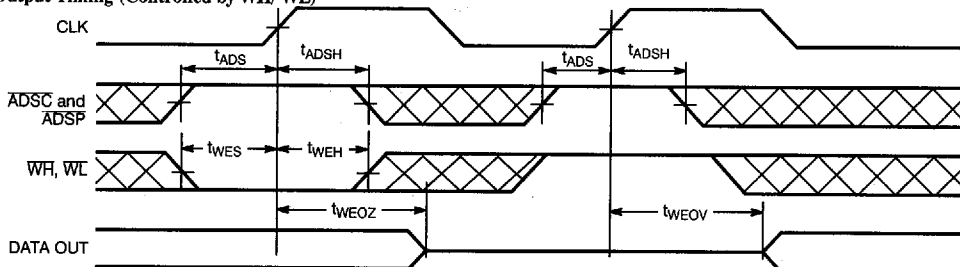
**Output Timing (Controlled by  $\overline{WH}/\overline{WL}$ )**

1031-13

**Truth Table**

Input						Address	Operation
CS	ADSP	ADSC	ADV	WH or WL	CLK		
H	X	L	X	X	L→H	N/A	Chip deselected
H	L	H	H	H	L→H	Same address as previous cycle	Read cycle (ADSP ignored)
H	L	H	L	H	L→H	Incremented burst address	Read cycle, in burst sequence (ADSP ignored)
H	L	H	H	L	L→H	Same address as previous cycle	Write cycle (ADSP ignored)
H	L	H	L	L	L→H	Incremented burst address	Write cycle, in burst sequence (ADSP ignored)
L	L	X	X	X	L→H	External	Read cycle, begin burst
L	H	L	X	H	L→H	External	Read cycle, begin burst
L	H	L	X	L	L→H	External	Write cycle, begin burst
X	H	H	L	L	L→H	Incremented burst address	Write cycle, in burst sequence
X	H	H	L	H	L→H	Incremented burst address	Read cycle, in burst sequence
X	H	H	H	L	L→H	Same address as previous cycle	Write cycle
X	H	H	H	H	L→H	Same address as previous cycle	Read cycle



Ordering Information

Speed (ns)	Ordering Code	Package Name	Package Type	Operating Range
7	CY7C1031-7JC	J69	52-Lead Plastic Leaded Chip Carrier	Commercial
	CY7C1031-7NC	TBD	52-Lead Plastic Quad Flatpack	
8	CY7C1031-8JC	J69	52-Lead Plastic Leaded Chip Carrier	Commercial
	CY7C1031-8NC	TBD	52-Lead Plastic Quad Flatpack	
10	CY7C1031-10JC	J69	52-Lead Plastic Leaded Chip Carrier	Commercial
	CY7C1031-10NC	TBD	52-Lead Plastic Quad Flatpack	
12	CY7C1031-12JC	J69	52-Lead Plastic Leaded Chip Carrier	Commercial
	CY7C1031-12NC	TBD	52-Lead Plastic Quad Flatpack	
	CY7C1031-12YMB	Y59	52-Pin Ceramic Leaded Chip Carrier	Military

Speed (ns)	Ordering Code	Package Name	Package Type	Operating Range
7	CY7C1032-7JC	J69	52-Lead Plastic Leaded Chip Carrier	Commercial
	CY7C1032-7NC	TBD	52-Lead Plastic Quad Flatpack	
8	CY7C1032-8JC	J69	52-Lead Plastic Leaded Chip Carrier	Commercial
	CY7C1032-8NC	TBD	52-Lead Plastic Quad Flatpack	
10	CY7C1032-10JC	J69	52-Lead Plastic Leaded Chip Carrier	Commercial
	CY7C1032-10NC	TBD	52-Lead Plastic Quad Flatpack	
12	CY7C1032-12JC	J69	52-Lead Plastic Leaded Chip Carrier	Commercial
	CY7C1032-12NC	TBD	52-Lead Plastic Quad Flatpack	
	CY7C1032-12YMB	Y59	52-Pin Ceramic Leaded Chip Carrier	Military

Shaded areas contain preliminary information.

Document #: 38-00219-B

2