



# AP513

## DCS-band 8W HBT Amplifier Module



### Product Features

- 1805 – 1880 MHz
- 30 dB Gain
- -64 dBc ACPR  
@ 28 dBm CDMA2k 7fa Power
- +39 dBm P1dB
- +12 V Single Supply
- Power Down Mode
- Bias Current Adjustable
- RoHS-complaint flange-mount pkg

### Applications

- Final stage amplifiers for Repeaters
- Optimized for driver amplifier PA mobile infrastructure

### Product Description

The AP513 is a high dynamic range power amplifier in a RoHS-compliant flange-mount package. The multi-stage amplifier module has 30 dB gain, while being able to achieve high performance for DCS-band applications with +39 dBm of compressed 1dB power. The module has been internally optimized for linearity to provide -64 dBc ACPR at 28 dBm power for 7-carrier CDMA2000 applications.

The AP513 uses a high reliability InGaP/GaAs HBT process technology and does not require any external matching components. The module operates off of a +12V supply and does not require any negative biasing voltages; an internal active bias allows the amplifier to maintain high linearity over temperature. It has the added feature of a +5V power down control pin. A low-cost metal housing allows the device to have a low thermal resistance and achieves over 100 years MTTF. All devices are 100% RF and DC tested.

The AP513 is targeted for use as a driver or final stage amplifier in wireless infrastructure where high linearity and high power is required. This combination makes the device an excellent candidate for next generation multi-carrier 3G base stations or repeaters using the DCS1800 frequency band.

### Functional Diagram

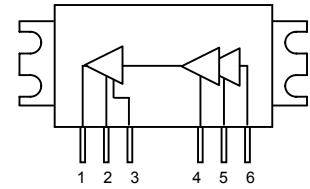

Top View

Pin No.	Function
1	RF Output
2 / 4	Vcc
3 / 5	Vpd
6	RF Input
Case	Ground

### Specifications <sup>(1)</sup>

Parameter	Units	Min	Typ	Max	Test Conditions
Operational Bandwidth	MHz	1805 – 1880			
Test Frequency	MHz	1840			
Adjacent Channel Power Ratio	dBc		-63.6	-60	CDMA2000 7fa +28 dBm Total Power, ±885 kHz offset
Power Gain	dB	27.8	30.3	32.8	Pout = +28 dBm
Input Return Loss	dB	14			
Output Return Loss	dB	7.8			
Output P1dB	dBm	+39			
Output IP3	dBm	+50			Pout = +28 dBm/tone, Δf = 1 MHz
Operating Current <sup>(2)</sup>	A	1.67			Pout = +28 dBm
Quiescent Current, Icq <sup>(2)</sup>	A	1.55	1.70	1.80	
Device Voltage, Vcc	V	+12			
Device Voltage, Vpd	V	+5			Pull-down voltage: 0V = "OFF", 5V="ON"
Ruggedness	VSWR	10:1			Pout = +39 dBm CW, all phases

1. Test conditions unless otherwise noted: 25 °C.

2. The current can be adjusted through an external resistor from the 5V supply to the pull-down voltage pin (pin 3).

### Absolute Maximum Rating

Parameter	Rating
Operating Case Temperature	-40 to +85 °C
Storage Temperature	-55 to +150 °C
RF Input Power (continuous) CDMA2000 signal (fwd link, PAR 10.5 dB @ .01% prob)	+10 dBm

Operation of this device above any of these parameters may cause permanent damage.

### Ordering Information

Part No.	Description
AP513	DCS-band 8W HBT Amplifier Module
AP513-PCB	Fully-Assembled Evaluation Board

Specifications and information are subject to change without notice



# AP513

## DCS-band 8W HBT Amplifier Module



### Class AB Configuration (AP513-PCB)

The AP513-PCB and AP513 module is configured for Class AB by default. The resistor – R7 – which sets the current draw for the amplifier is set at 0 Ω in this configuration. Increasing that value will decrease the quiescent and operating current of the amplifier module, as described on the next page.

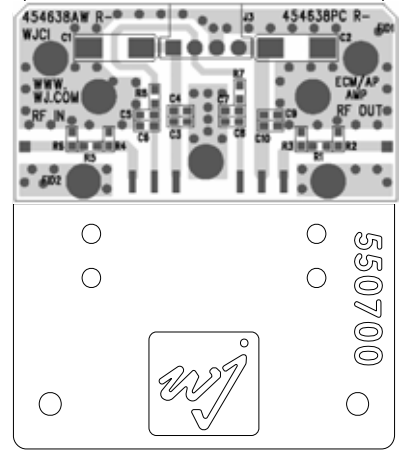
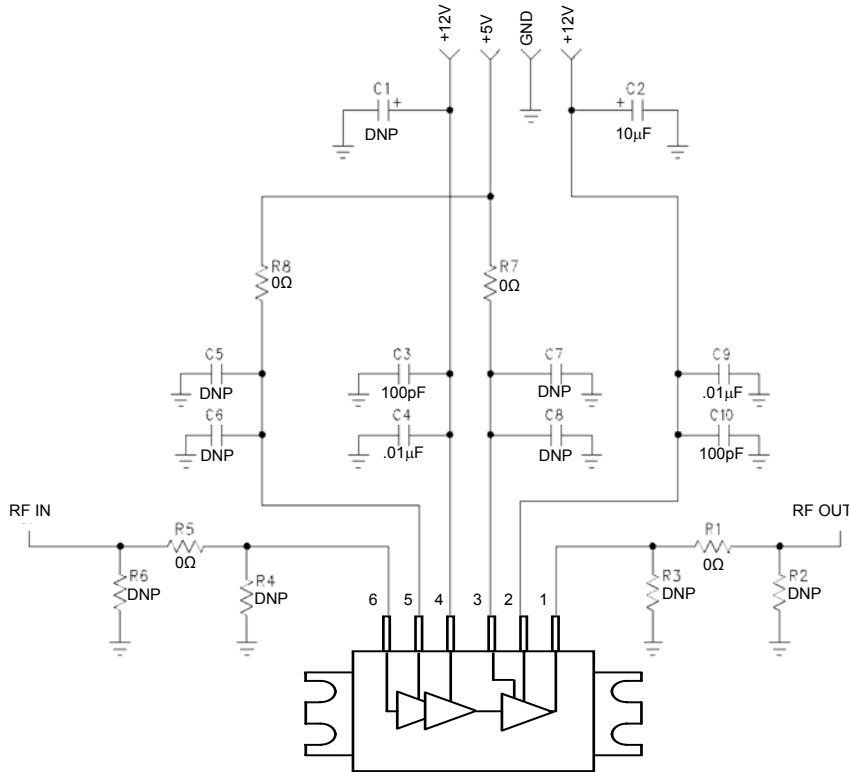

Notes:

1. **Please note that for reliable operation, the evaluation board and mounting plate will have to be attached to a much larger heat sink during operation and in laboratory environments to dissipate the power consumed by the device.** The use of a convection fan is also recommended in laboratory environments. Details of the mounting holes used in the WJ mounting plate are given on the last page of this datasheet.
2. The area around the module underneath the PCB should not contain any soldermask in order to maintain good RF grounding.
3. For proper and safe operation in the laboratory, the power-on sequencing should be followed:
  1. Connect RF In and Out
  2. Connect the voltages and ground pins as shown in the circuit.
  3. Apply the RF signal
  4. Power down with the reverse sequence



### Performance Graphs (AP513-PCB)

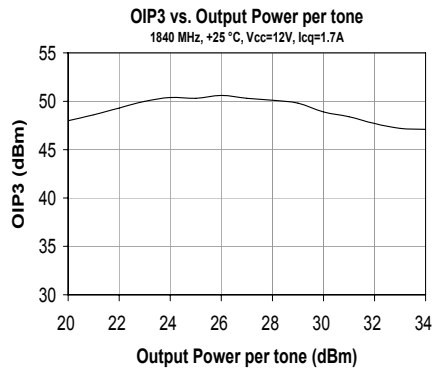
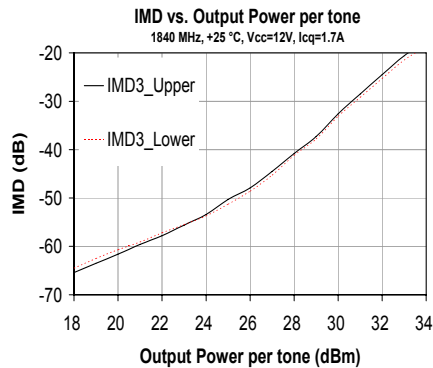
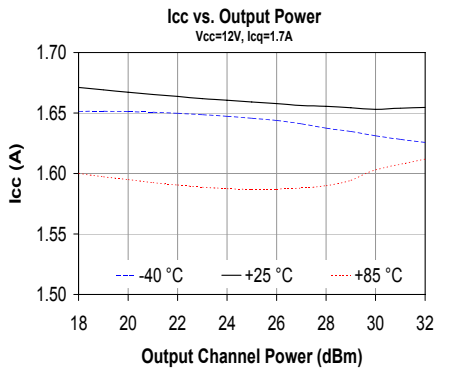
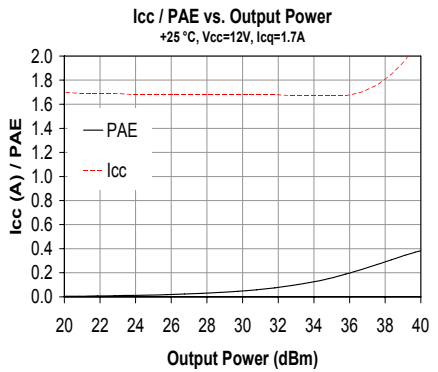
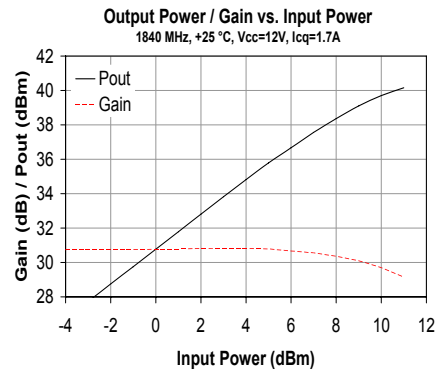
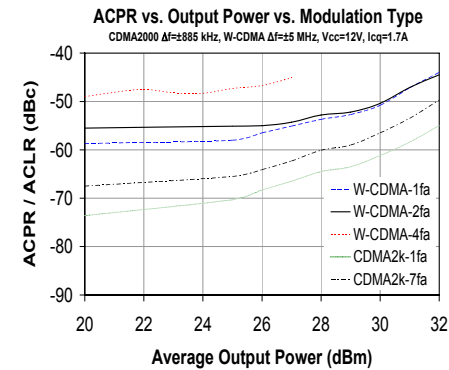
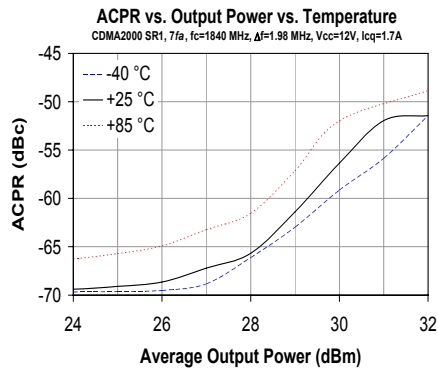
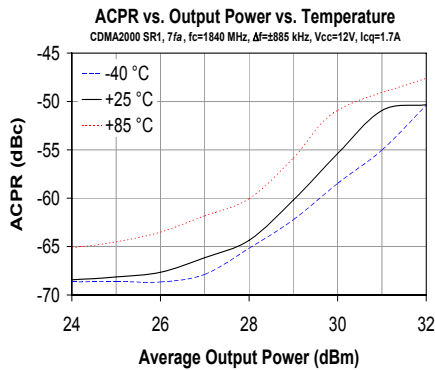
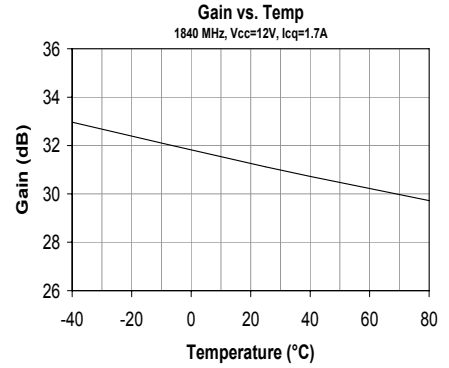
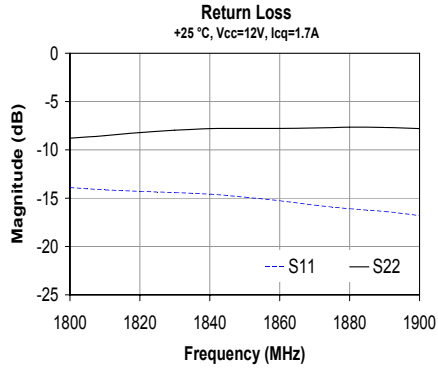
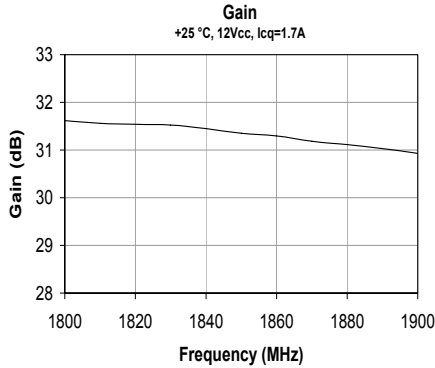



### MTTF Calculation

The MTTF of the AP513 can be calculated by first determining how much power is being dissipated by the amplifier module. Because the device's intended application is to be a power amplifier pre-driver or final stage output amplifier, the output RF power of the amplifier will help lower the overall power dissipation. In addition, the amplifier can be biased with different quiescent currents, so the calculation of the MTTF is custom to each application.

The power dissipation of the device can be calculated with the following equation:

$$P_{diss} = V_{cc} * I_{cc} - (\text{Output RF Power} - \text{Input RF Power}),$$

$V_{cc}$  = Operating supply voltage = **12V**  
 $I_{cc}$  = Operating current  
 {The RF power is converted to Watts}

While the maximum recommended case temperature on the datasheet is listed at 85 °C, it is suggested that customers maintain an MTTF above 1 million hours. This would convert to a derating curve for maximum case temperature vs. power dissipation as shown in the plot below.

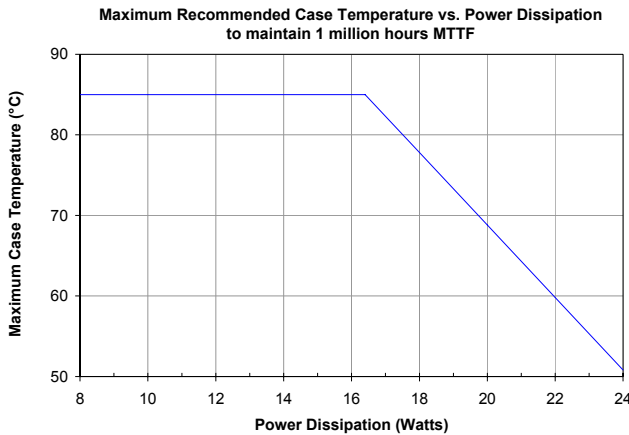

To calculate the MTTF for the module, the junction temperature needs to be determined. This can be easily calculated with the module's power dissipation, the thermal resistance value, and the case temperature of operation:

$$T_j = P_{diss} * R_{th} + T_{case}$$

$T_j$  = Junction temperature  
 $P_{diss}$  = Power dissipation (calculated from above)  
 $R_{th}$  = Thermal resistance = **4.5 °C/W**  
 $T_{case}$  = Case temperature of module's heat sink

From a numerical standpoint, the MTTF can be calculated using the Arrhenius equation:

$$MTTF = A * e^{(E_a/k/T_j)}$$

$A$  = Pre-exponential Factor = **6.087 x 10<sup>-11</sup> hours**  
 $E_a$  = Activation Energy = **1.39 eV**  
 $k$  = Boltzmann's Constant = **8.617 x 10<sup>-5</sup> eV/°K**  
 $T_j$  = Junction Temperature (°K) =  $T_j$  (°C) + 273

A graphical view of the MTTF can be shown in the plot below.

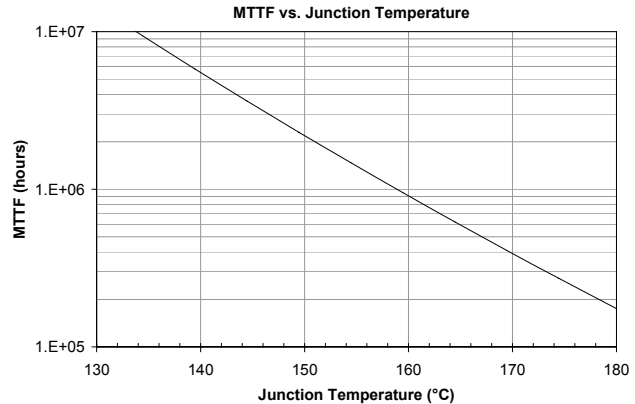



# AP513

## DCS-band 8W HBT Amplifier Module



### Outline Drawing

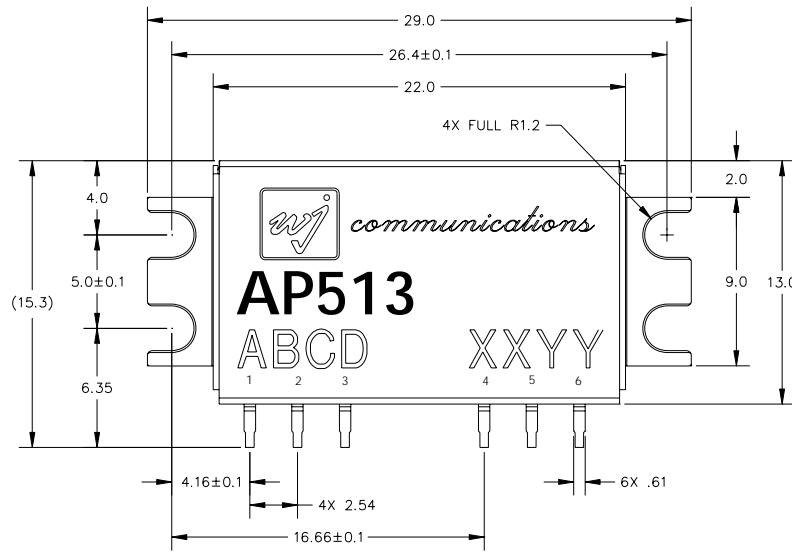

#### NOTES:

1. DIMENSIONING & TOLERANCING CONFORM TO ANSI Y14.4M-1994.
2. ALL DIMENSIONS ARE IN MILLIMETERS (INCHES). ANGLES ARE IN DEGREES.
3. PIN ASSIGNMENTS:  
 [PIN 1] RF OUT  
 [PIN 2] +12 Vcc  
 [PIN 3] Vpd  
 [PIN 4] +12 Vcc  
 [PIN 5] Vpd  
 [PIN 6] RF IN  
 [CASE] GROUND

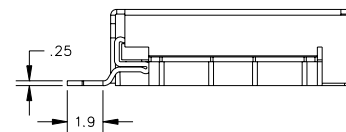
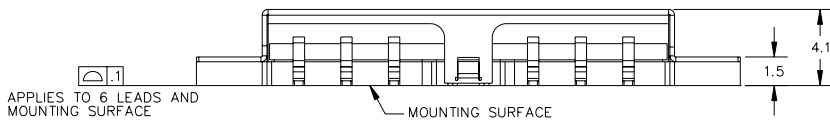

### Outline Drawing for the Heatsink Shipped with the WJ Evaluation Board

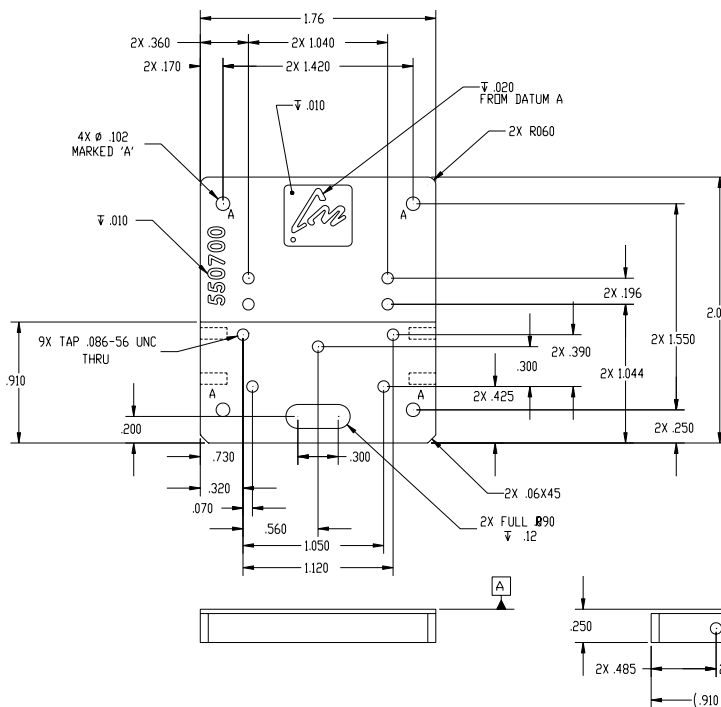

### Product Marking

The device will be marked with an “AP513” designator with an alphanumeric lot code on the top surface of the package noted as “ABCD” on the drawing. A manufacturing date will also be printed as “XXYY”, where the “XX” represents the week number from 1 – 52.

The product will be shipped in tubes in multiples of 15.

### ESD / MSL Information



**Caution!** ESD sensitive device.

ESD Rating: Class 1C  
 Value: Passes at  $\geq 1,000$  to  $< 2,000$  volts  
 Test: Human Body Model (HBM)  
 Standard: JEDEC Standard JESD22-A114

ESD Rating: Class III  
 Value: Passes  $\geq 500$  to  $< 1,000$  volts  
 Test: Charged Device Model (CDM)  
 Standard: JEDEC Standard JESD22-C101

**The supplied mounting plate with the evaluation board should be mounted and attached to a larger heatsink for proper thermal operation in a laboratory environment.**

Specifications and information are subject to change without notice