

Agilent T-1³/₄ (5 mm) Precision Optical Performance InGaN Blue and Green Lamps

Data Sheet

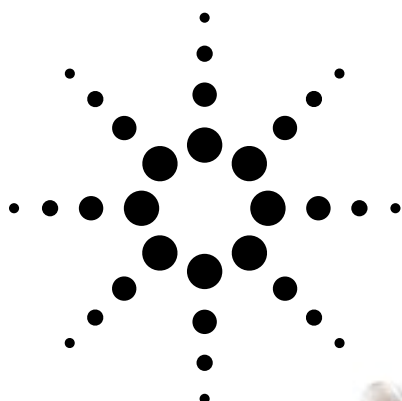

**HLMP-CB15, HLMP-CB16, HLMP-CB30, HLMP-CB31,
HLMP-CM15, HLMP-CM16, HLMP-CM30, HLMP-CM31**

Description

These high intensity blue and green LEDs are based on InGaN material technology. InGaN is the most efficient and cost effective material for LEDs in the blue and green region of the spectrum. The 472 nm typical dominant wavelength for blue and 526 nm typical dominant wavelength for green are well suited to color mixing in full color signs.

These LED lamps are untinted, nondiffused, T-1³/₄ packages incorporating second generation optics producing well defined spatial radiation patterns at specific viewing cone angles.

These lamps are made with an advanced optical grade epoxy, offering superior high temperature and high moisture resistance performance in outdoor signal and sign applications. The high maximum LED junction temperature limit of +130°C enables high temperature operation in bright sunlight conditions. The package epoxy contains both UV-A and UV-B inhibitors to reduce the effects of long term exposure to direct sunlight.

These lamps are available in two viewing angle options to give the designer flexibility with optical design.

Features

- Well defined spatial radiation pattern
- Viewing angles: 15° and 30°
- High luminous output
- Colors: 472 nm Blue, 526 nm Green
- Superior resistance to moisture
- UV resistant epoxy

Benefits

- Superior performance in outdoor environments
- Wavelengths suitable for color mixing in full color (RGB) signs

Applications

- Commercial outdoor signs
- Automotive interior lights
- Front panel indicators
- Front panel backlighting

CAUTION: HLMP-CBxx and HLMP-CMxx LEDs are Class 1 ESD sensitive. Please observe appropriate precautions during handling and processing. Refer to Agilent Application Note AN-1142 for additional details.

LED Indicators

Device Selection Guide

Part Number	Typical Viewing Angle	Color and Typ. Dominant Wavelength λ_d (nm)	Min. Luminous Intensity, I _v (mcd) at 20 mA	Typical Forward Voltage (V) at 20 mA	Leads with Stand-Offs	Package Drawing
HLMP-CB15-P00xx	15°	Blue 472	880	3.8	No	A
HLMP-CB15-R00xx	15°	Blue 472	1500	3.5	No	A
HLMP-CB15-QT0xx	15°	Blue 472	1150	3.8	No	A
HLMP-CB16-P00xx	15°	Blue 472	880	3.8	Yes	B
HLMP-CB16-QT0xx	15°	Blue 472	1150	3.8	Yes	B
HLMP-CB30-K00xx	30°	Blue 472	310	3.8	No	A
HLMP-CB30-KN0xx	30°	Blue 472	310	3.8	No	A
HLMP-CB30-M00xx	30°	Blue 472	520	3.8	No	A
HLMP-CB30-MQ0xx	30°	Blue 472	520	3.8	No	A
HLMP-CB30-NRGxx	30°	Blue 472	680	3.8	No	A
HLMP-CB31-M00xx	30°	Blue 472	520	3.8	Yes	B
HLMP-CB31-M0Gxx	30°	Blue 472	520	3.8	Yes	B
HLMP-CB31-NRGxx	30°	Blue 472	680	3.8	Yes	B
HLMP-CM15-S00xx	15°	Green 526	1900	3.8	No	A
HLMP-CM15-SV0xx	15°	Green 526	1900	3.8	No	A
HLMP-CM15-W00xx	15°	Green 526	5500	3.5	No	A
HLMP-CM15-VY0xx	15°	Green 526	4200	3.8	No	A
HLMP-CM16-S00xx	15°	Green 526	1900	3.8	Yes	B
HLMP-CM16-VY0xx	15°	Green 526	4200	3.8	Yes	B
HLMP-CM30-M00xx	30°	Green 526	520	3.8	No	A
HLMP-CM30-MQ0xx	30°	Green 526	520	3.8	No	A
HLMP-CM30-S00xx	30°	Green 526	1900	3.5	No	A
HLMP-CM30-TWAxx	30°	Green 526	2500	3.8	No	A
HLMP-CM31-M00xx	30°	Green 526	520	3.8	Yes	B
HLMP-CM31-TWAxx	30°	Green 526	2500	3.8	Yes	B

Tolerance for intensity limit is $\pm 15\%$.

Part Numbering System

HLMP - X X XX - X X X XX

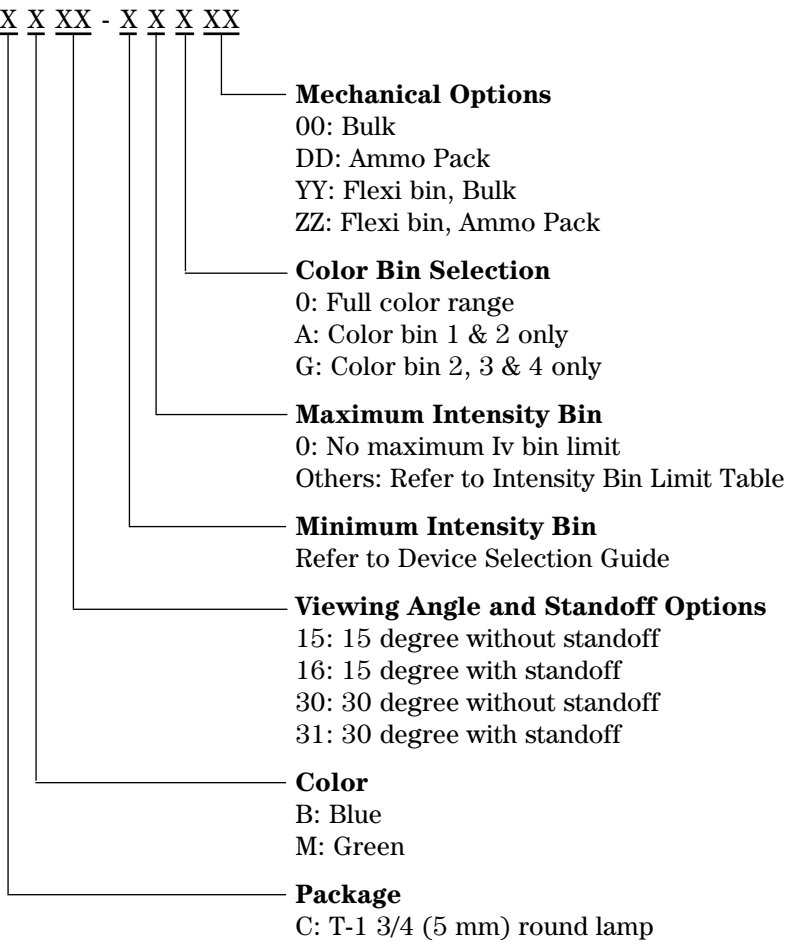

Package Dimensions

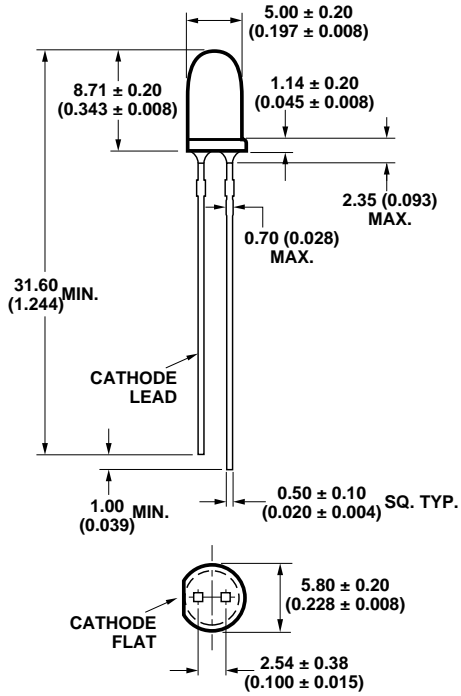

HLMP-Cx15 and HLMP-Cx30

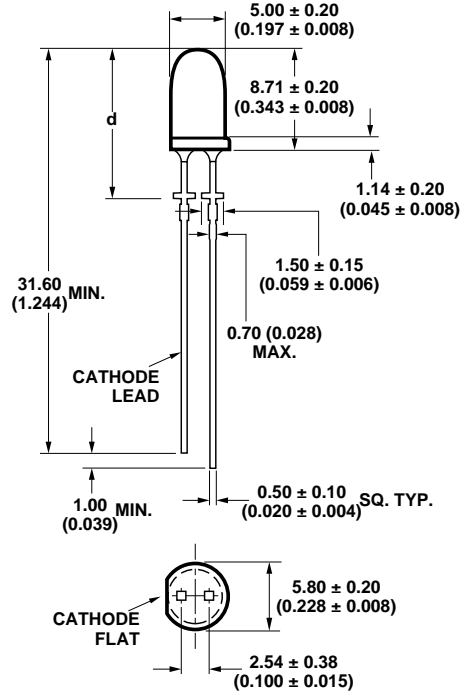

HLMP-Cx16 and HLMP-Cx31

HLMP-Cx16	HLMP-Cx31
d = 12.60 ± 0.25 (0.496 ± 0.010)	d = 12.22 ± 0.50 (0.481 ± 0.020)

Notes:

1. Dimensions in mm.
2. Tolerance ±0.1 mm unless otherwise noted.

Absolute Maximum Ratings at T_A = 25°C

Parameter	Blue and Green
DC Forward Current ^[1]	30 mA
Peak Pulsed Forward Current	100 mA
Average Forward Current	30 mA
Reverse Voltage (I _R = 100 μA)	5 V
Power Dissipation	120 mW
LED Junction Temperature	130°C
Operating Temperature Range	-40°C to +80°C
Storage Temperature Range	-40°C to +100°C
Soldering Temperature	260°C for 5 seconds

Note:

1. Derate linearly as shown in Figure 5 for temperatures above 50°C.

Electrical/Optical Characteristics at T_A = 25°C

Parameter	Symbol	Min.	Typ.	Max.	Units	Test Conditions
Forward Voltage	V _F		3.5	4.0	V	I _F = 20 mA
Reverse Voltage	V _R	5				I _R = 100 μA
Peak Wavelength						Peak of Wavelength of Spectral Distribution at I _F = 20 mA
Blue (λ _d = 472 nm)	λ _{peak}		470		nm	
Green (λ _d = 526 nm)			524			
Spectral Halfwidth						Wavelength Width at Spectral Power Point at I _F = 20 mA
Blue (λ _d = 472 nm)	Δλ _{1/2}		35		nm	
Green (λ _d = 526 nm)			47			
Capacitance	C		43		pF	V _F = 0, F = 1 MHz
Luminous Efficacy						Emitted Luminous Power/Emitted Radiant Power
Blue (λ _d = 472 nm)	η _v		75		lm/W	
Green (λ _d = 526 nm)			520			
Thermal Resistance	R _{ΘJ-PIN}		240		°C/W	LED Junction-to-Cathode Lead

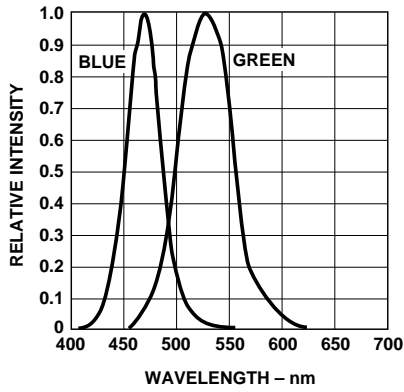

Figure 1. Relative intensity vs. wavelength.

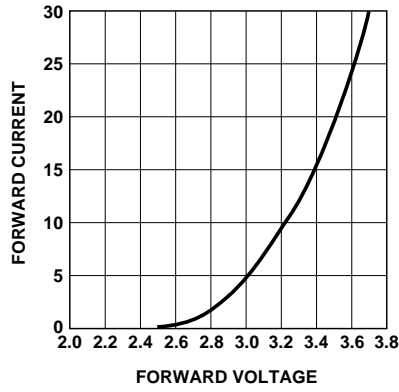

Figure 2. Forward current vs. forward voltage for devices with 3.5 V typical Vf.

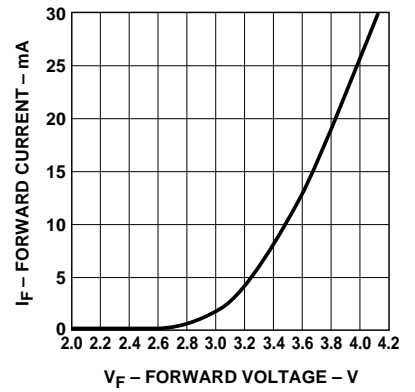

Figure 3. Forward current vs. forward voltage for devices with 3.8 V typical Vf.

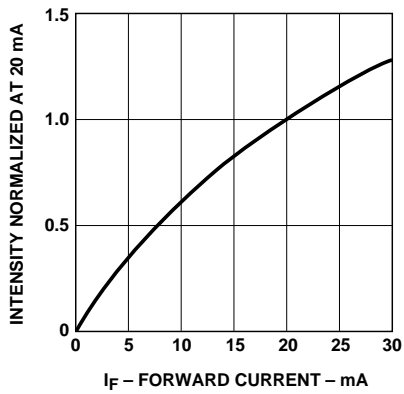

Figure 4. Relative luminous intensity vs. forward current.

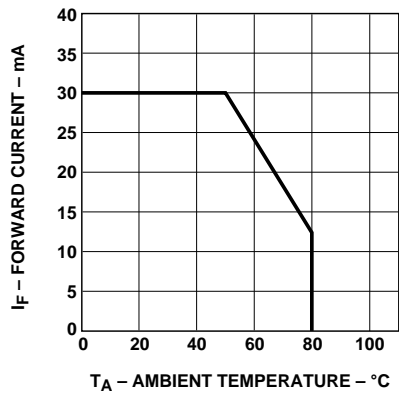

Figure 5. Maximum forward current vs. ambient temperature.

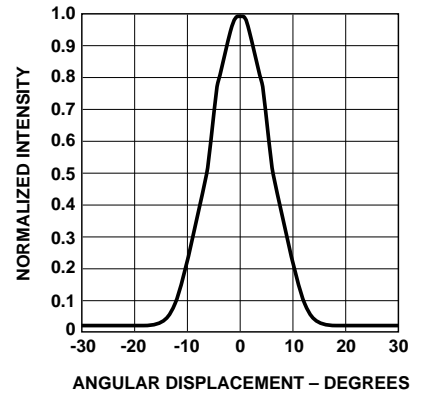

Figure 6. Spatial radiation pattern - 15° lamps.

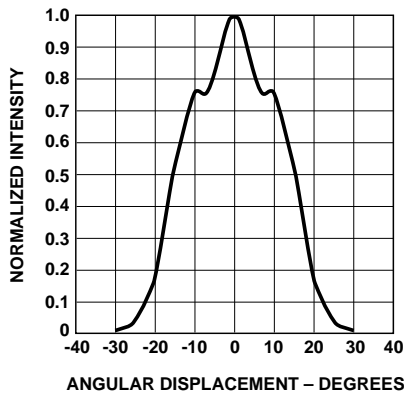

Figure 7. Spatial radiation pattern - 30° lamps.

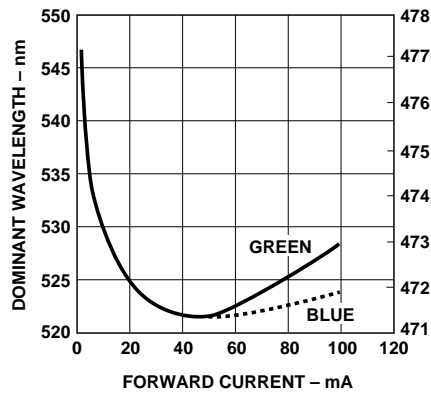

Figure 8. Color vs. forward current.

Color Bin Limits (nm at 20 mA)

Blue	Color Range (nm)	
	Bin ID	Max.
1	460.0	464.0
2	464.0	468.0
3	468.0	472.0
4	472.0	476.0
5	476.0	480.0

Tolerance for each bin limit is ± 0.5 nm.

Green

Green	Color Range (nm)	
	Bin ID	Max.
1	520.0	524.0
2	524.0	528.0
3	528.0	532.0
4	532.0	536.0
5	536.0	540.0

Tolerance for each bin limit is ± 0.5 nm.

Intensity Bin Limits

Bin Name	Min.	Max.
K	310	400
L	400	520
M	520	680
N	680	880
P	880	1150
Q	1150	1500
R	1500	1900
S	1900	2500
T	2500	3200
U	3200	4200
V	4200	5500
W	5500	7200
X	7200	9300
Y	9300	12000
Z	12000	16000

Tolerance for each intensity bin limit is $\pm 15\%$.

Note:

1. All bin categories are established for classification of products. Products may not be available in all bin categories. Please contact your Agilent representatives for further information.

www.agilent.com/semiconductors

For product information and a complete list of distributors, please go to our web site.

For technical assistance call:

Americas/Canada: +1 (800) 235-0312 or
(916) 788-6763

Europe: +49 (0) 6441 92460

China: 10800 650 0017

Hong Kong: (+65) 6271 2451

India, Australia, New Zealand: (+65) 6271 2394

Japan: (+81 3) 3335-8152(Domestic/International), or 0120-61-1280(Domestic Only)

Korea: (+65) 6271 2194

Malaysia, Singapore: (+65) 6271 2054

Taiwan: (+65) 6271 2654

Data subject to change.

Copyright © 2003 Agilent Technologies, Inc.

Obsoletes 5988-8658EN

August 1, 2003

5988-9962EN



Agilent Technologies