



# TDA7309

## DIGITAL CONTROLLED STEREO AUDIO PROCESSOR WITH LOUDNESS

- INPUT MULTIPLEXER:  
3 STEREO INPUTS
- RECORD OUTPUT FUNCTION
- LOUDNESS FUNCTION
- VOLUME CONTROL IN 1dB STEPS
- INDEPENDENT LEFT AND RIGHT VOLUME CONTROL
- SOFT MUTE FUNCTION
- ALL FUNCTIONS PROGRAMMABLE VIA SERIAL I<sup>2</sup>C BUS

### DESCRIPTION

The TDA7309 is a control processor with independent left and right volume control for quality audio applications. Selectable external loudness and soft mute functions are provided.

Control is accomplished by serial I<sup>2</sup>C bus micro-processor interface.

The AC signal setting is obtained by resistor net-

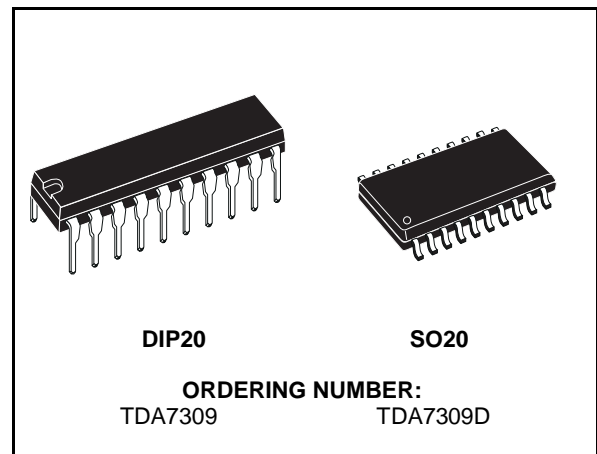

works and switches combined with operational amplifiers.

Thanks to the used BIPOLAR/CMOS Technology, Low Distortion, Low Noise and Low DC stepping are obtained.

### BLOCK DIAGRAM

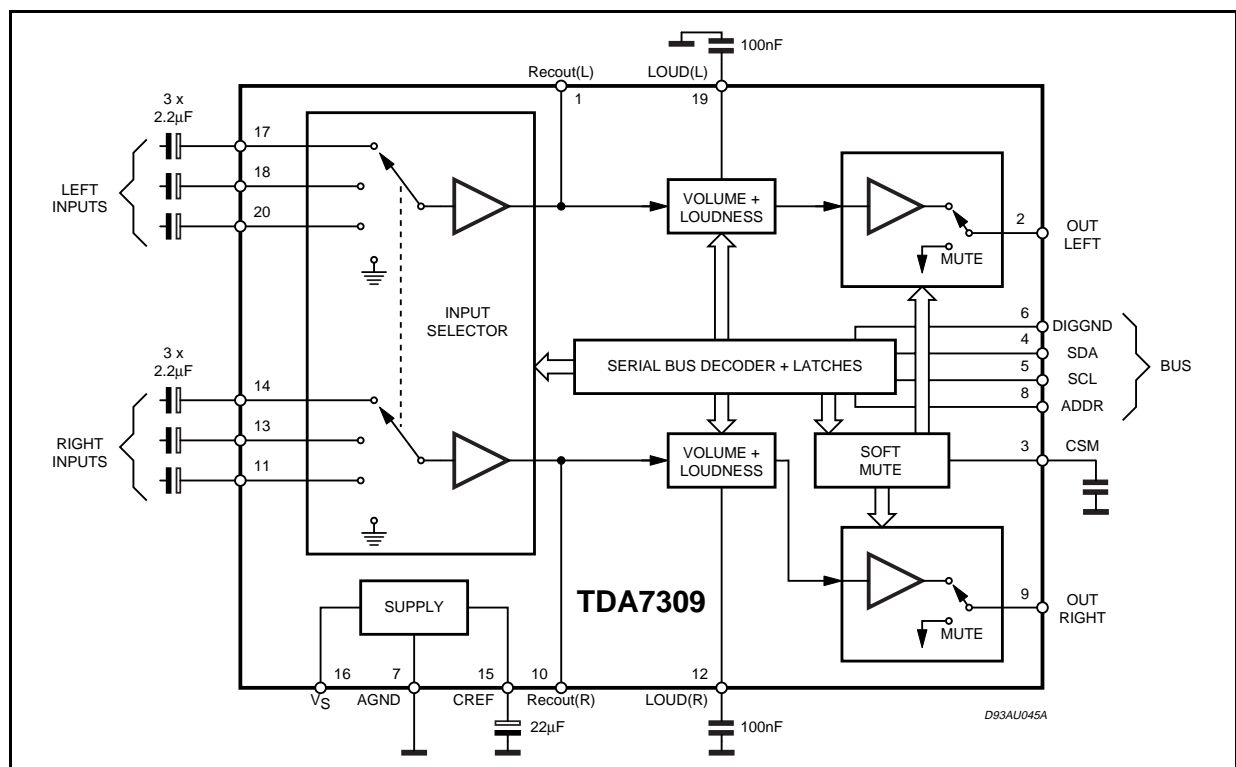

**PIN CONNECTION (Top View)**

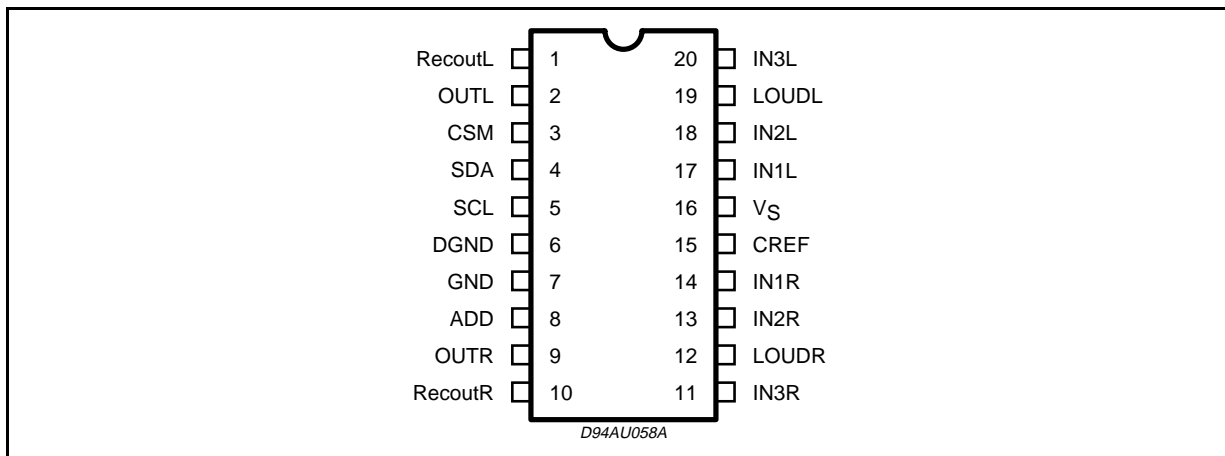

**ABSOLUTE MAXIMUM RATINGS**

Symbol	Parameter	Value	Unit
V <sub>S</sub>	Operating Supply Voltage	10.5	V
T <sub>amb</sub>	Operating Ambient Temperature	-40 to 85	°C
T <sub>stg</sub>	Storage Temperature Range	-55 to +150	°C

**QUICK REFERENCE DATA**

Symbol	Parameter	Test Condition	Min.	Typ.	Max.	Unit
V <sub>S</sub>	Operating Supply Voltage		6		10	V
V <sub>CL</sub>	Max. Input Signal Handling		2			V <sub>rms</sub>
THD	Total Harmonic Distortion	V = 1V <sub>rms</sub> , f = 1KHz		0.01	0.1	%
S/N	Signal to Noise Ratio			106		dB
Sc	Channel Separation f = 1KHz			100		dB
	Volume Control 1.0dB step		-95		0	dB
	Soft Mute Attenuation			60		dB
	Direct Mute Attenuation			100		dB

**TEST CIRCUIT**

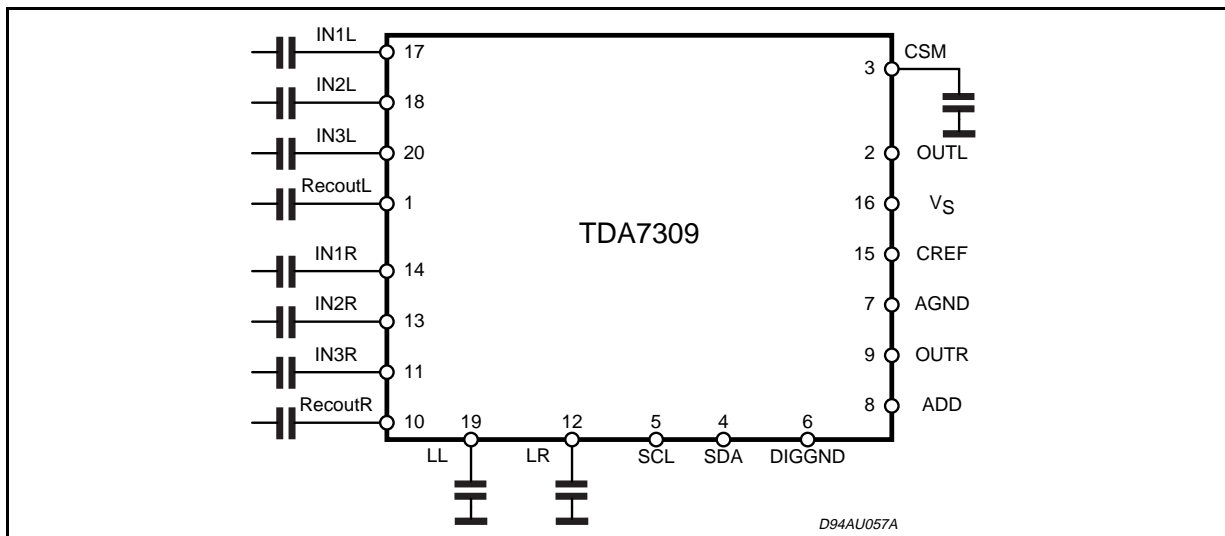

## THERMAL DATA

Symbol	Parameter	SO20	DIP20	Unit
$R_{th\ j-pins}$	Thermal resistance Junction to Pins	150	100	°C/W

**ELECTRICAL CHARACTERISTICS** (Refer to the test circuit,  $T_{amb} = 25^{\circ}\text{C}$ ,  $V_S = 9\text{V}$ ,  $R_L = 10\text{K}\Omega$ ,  $R_G = 50\Omega$ , all controls flat ( $G = 0$ ),  $f = 1\text{KHz}$  unless otherwise specified.)

Symbol	Parameter	Test Condition	Min.	Typ.	Max.	Unit
--------	-----------	----------------	------	------	------	------

## SUPPLY

$V_S$	Supply Voltage		5 (*)	9	10	V
$I_S$	Supply Current			7	10	mA
SVR	Ripple Rejection		60	85		dB

## INPUT SELECTORS

$R_I$	Input Resistance		35	50	65	K $\Omega$
$S_{in}$	Input Separation		80	90		dB

## VOLUME CONTROL

$C_{RANGE}$	Control Range			92		dB
$A_{VMAX}$	Max. Attenuation		87	92	95	dB
$A_{STEP}$	Step resolution		0.5	1	1.5	dB
$E_A$	Attenuation Set Error	$A_V = 0$ to $-24\text{dB}$	-1.2		1.2	dB
		$A_V = -24$ to $-56\text{dB}$	-3		2	dB
$E_T$	Tracking Error				2	dB
$V_{DC}$	DC Steps	adjacent attenuation steps		0	3	mV
		from 0dB to $A_V$ max.		0.5	5	mV
$A_{mute}$	Output Mute Attenuation		80	100		dB

## SOFT MUTE

$T_d$	Delay Time	$C_{smute} = 22\text{nF}$ 0 to $-20\text{dB}$ Fast Mode Slow Mode		1 20		ms ms
-------	------------	---	--	---------	--	----------

## AUDIO OUTPUTS

$V_{CLIP}$	Clipping Level	$d = 0.3\%$	2	2.6		V <sub>rms</sub>
$R_L$	Output Load Resistance		2			K $\Omega$
$R_{out}$	Output Impedance		100	200	300	$\Omega$
$V_{DC}$	DC Voltage Level			3.8		V

## GENERAL

$e_{NO}$	Output Noise	BW = 20-20KHz, flat output muted all gains = 0dB		2.5 5	15	$\mu\text{V}$ $\mu\text{V}$
		A curve all gains = 0dB		3		$\mu\text{V}$
$E_t$	Total Tracking Error	$A_V = 0$ to $-24\text{dB}$		0	1	dB
		$A_V = -24$ to $-56\text{dB}$		0	2	dB
S/N	Signal to Noise Ratio	all gains = 0dB; $V_O = 1\text{V}_{rms}$	95	106		dB
d	Distortion			0.01	0.1	%
$S_C$	Channel Separation		80	100		dB

## BUS INPUTS

$V_{IL}$	Input Low Voltage				1	V
$V_{IH}$	Input High Voltage		3			V
$I_{IN}$	Input Current	$V_{in} = 0.4\text{V}$	-5		+5	$\mu\text{A}$
$V_O$	Output Voltage SDA Acknowledge	$I_O = 1.6\text{mA}$		0.4	0.8	V

(\*) Hedevice work until 5V but no guarantee about SVR

Figure 1: Noise vs. volume setting.

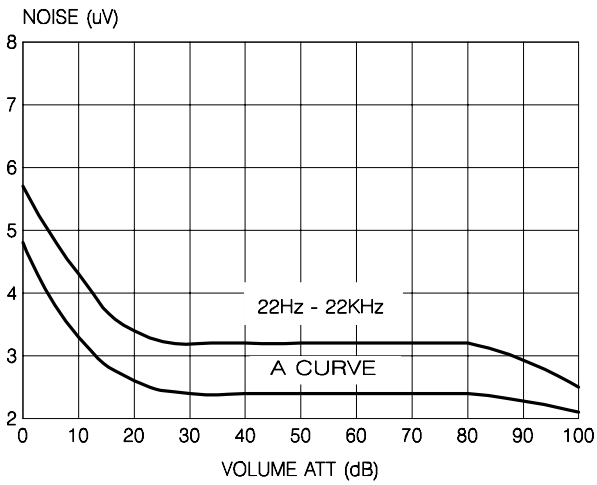

Figure 2: SVRR vs. frequency.

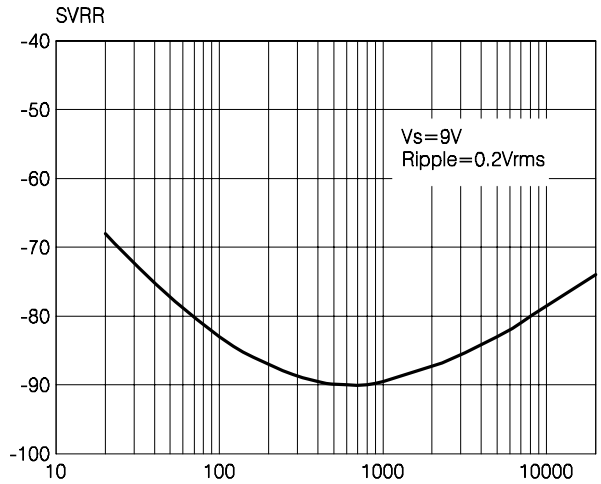

Figure 3: THD vs. frequency

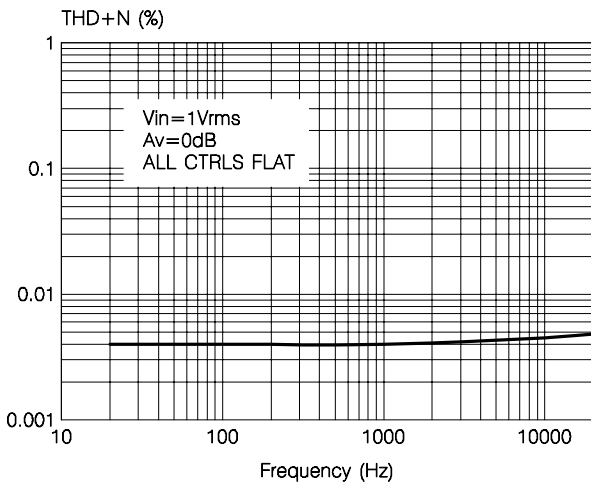

Figure 4: THD vs. RLOAD.

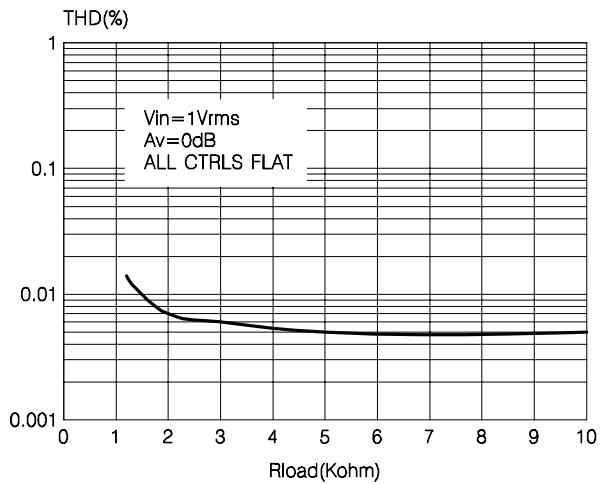

Figure 5: Channel separation vs. frequency.

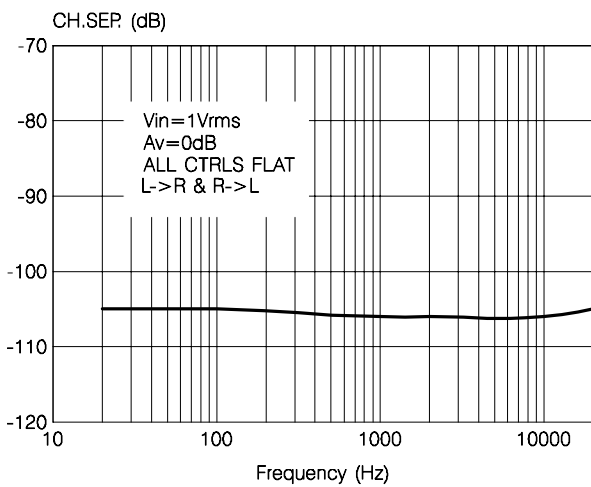
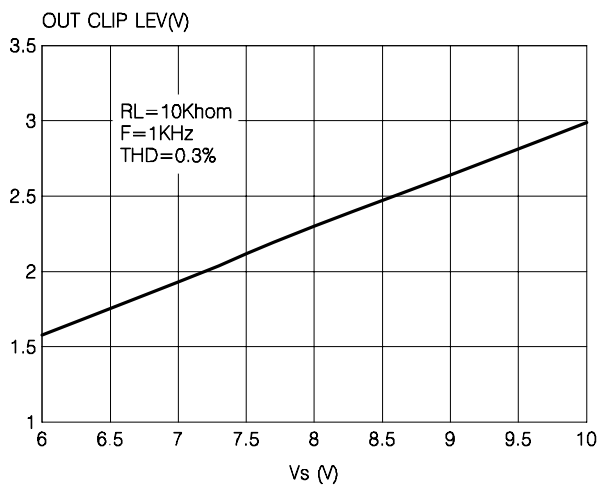
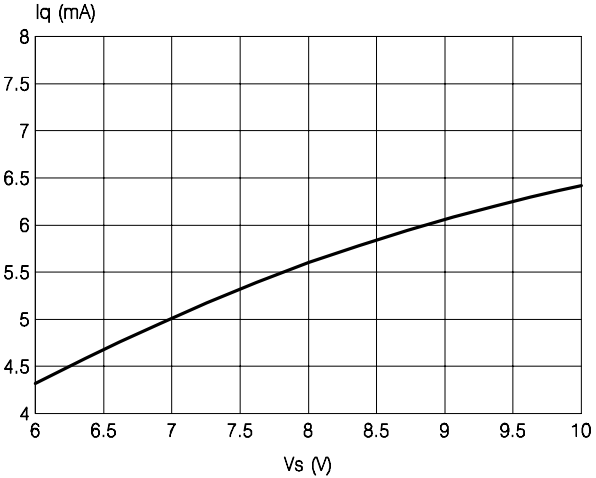

Figure 6: Output clip level vs. Supply Voltage.



**Figure 7:** Quiescent current vs. supply voltage.



**Figure 8:** Loudness vs. Volume Attenuation.

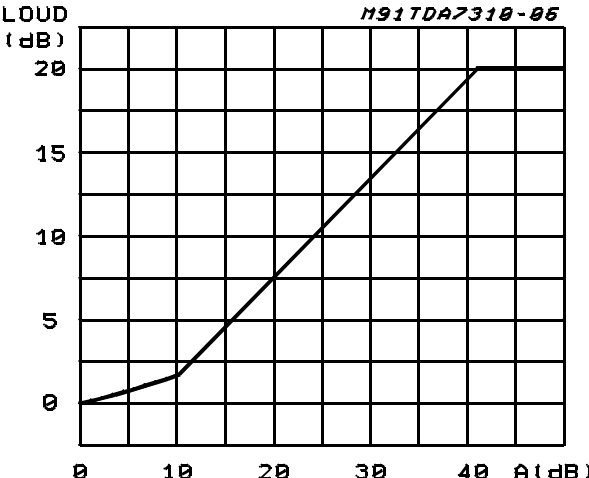

**Figure 9:** Loudness vs. Frequency (CLOUD = 100nF) vs. Volume

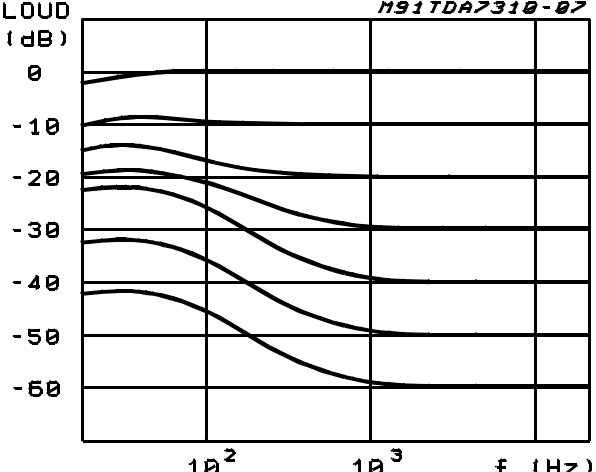

**Figure 10:** Loudness vs. External Capacitors

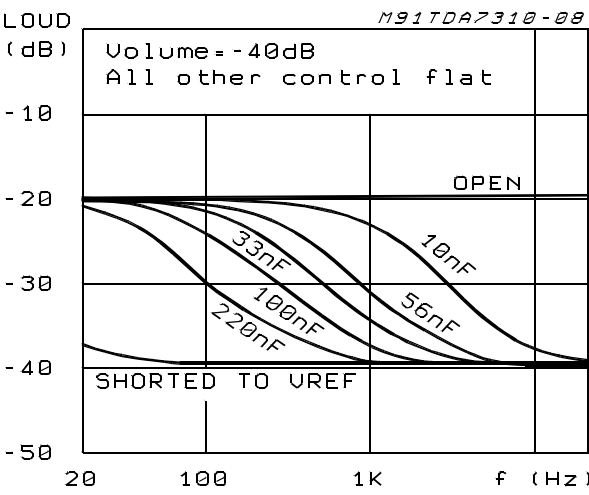

**I<sup>2</sup>C BUS INTERFACE**

Data transmission from microprocessor to the TDA7313 and viceversa takes place thru the 2 wires I<sup>2</sup>C BUS interface, consisting of the two lines SDA and SCL (pull-up resistors to positive supply voltage must be connected).

**Data Validity**

As shown in fig. 11, the data on the SDA line must be stable during the high period of the clock. The HIGH and LOW state of the data line can only change when the clock signal on the SCL line is LOW.

**Start and Stop Conditions**

As shown in fig. 12 a start condition is a HIGH to LOW transition of the SDA line while SCL is HIGH. The stop condition is a LOW to HIGH transition of the SDA line while SCL is HIGH.

**Byte Format**

Every byte transferred on the SDA line must contain 8 bits. Each byte must be followed by an acknowledge bit. The MSB is transferred first.

**Acknowledge**

The master ( $\mu$ P) puts a resistive HIGH level on the SDA line during the acknowledge clock pulse (see fig. 13). The peripheral (audioprocessor) that acknowledges has to pull-down (LOW) the SDA line during the acknowledge clock pulse, so that the SDA line is stable LOW during this clock pulse.

The audioprocessor which has been addressed has to generate an acknowledge after the reception of each byte, otherwise the SDA line remains at the HIGH level during the ninth clock pulse time. In this case the master transmitter can generate the STOP information in order to abort the transfer.

**Transmission without Acknowledge**

Avoiding to detect the acknowledge of the audioprocessor, the  $\mu$ P can use a simpler transmission: simply it waits one clock without checking the slave acknowledging, and sends the new data.

This approach of course is less protected from misworking and decreases the noise immunity.

**Figure 11:** Data Validity on the I<sup>2</sup>C BUS

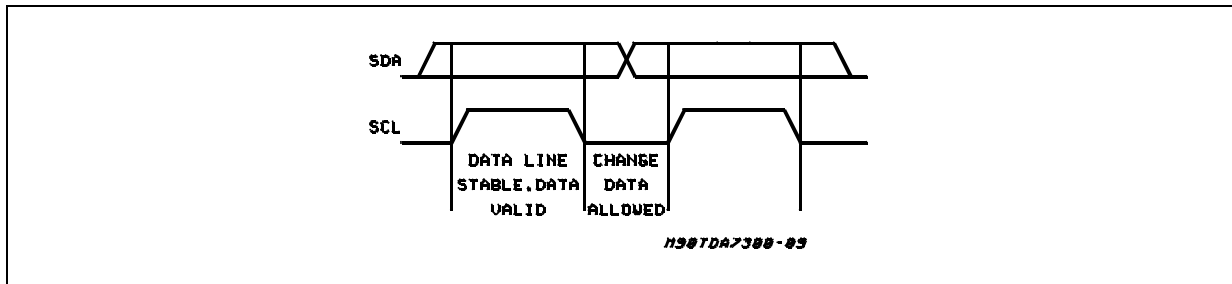

**Figure 12:** Timing Diagram of I<sup>2</sup>C BUS

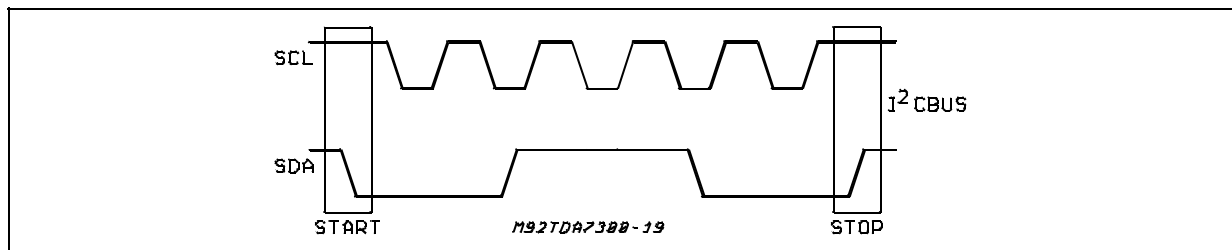

**Figure 13:** Acknowledge on the I<sup>2</sup>C BUS

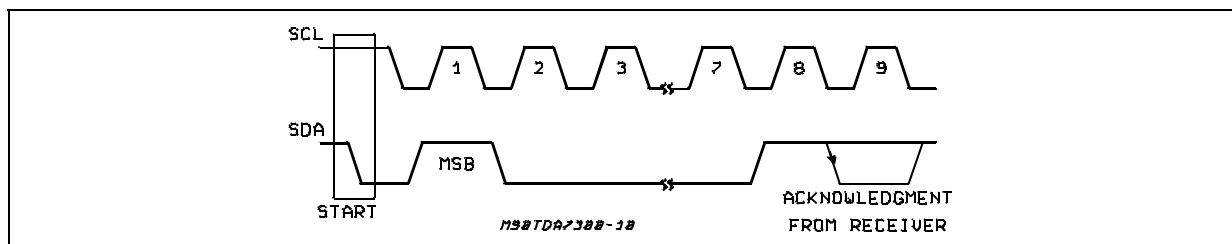

**SDA, SCL I<sup>2</sup>C BUS TIMING**

Symbol	Parameter	Min.	Typ.	Max.	Unit
f <sub>SCL</sub>	SCL clock frequency	0		400	kHz
t <sub>BUF</sub>	Bus free time between a STOP and START condition	1.3			μs
t <sub>HD:STA</sub>	Hold time (repeated) START condition. After this period, the first clock pulse is generated	0.6			μs
t <sub>LOW</sub>	LOW period of the SCL clock	1.3			μs
t <sub>HIGH</sub>	HIGH period of the SCL clock	0.6			μs
t <sub>SU:STA</sub>	Set-up time for a repeated START condition	0.6			μs
t <sub>HD:DA</sub>	Data hold time	0.300			μs
t <sub>SU:DAT</sub>	Data set-up time	100			ns
t <sub>R</sub>	Rise time of both SDA and SCL signals	20		300	ns (*)
t <sub>F</sub>	Fall time of both SDA and SCL signals	20		300	ns (*)
t <sub>SU:STO</sub>	Set-up time for STOP condition	0.6			μs

All values referred to V<sub>IH min.</sub> and V<sub>IL max.</sub> levels  
 (\*) Must be guaranteed by the I<sup>2</sup>C BUS master.

**Definition of timing on the I<sup>2</sup>C-bus**

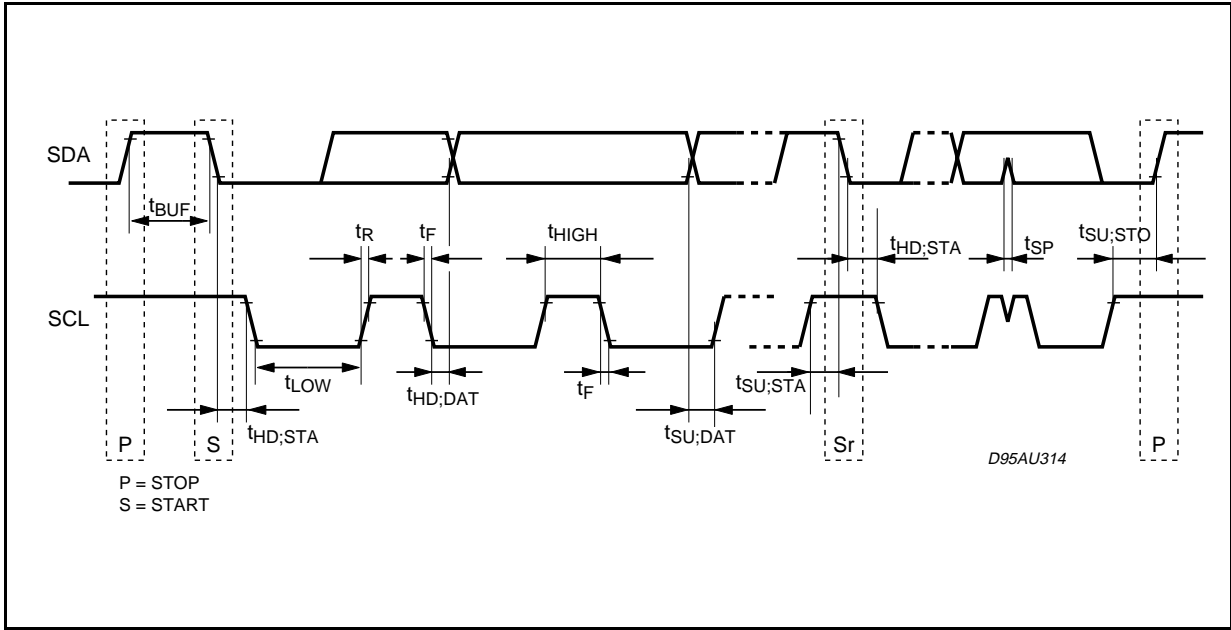

# TDA7309

## SOFTWARE SPECIFICATION

### Interface Protocol

The interface protocol comprises:

- A start condition (s)
- A chip address byte, containing the TDA7309

address (the 8th bit of the byte must be 0). The TDA7309 must always acknowledge at the end of each transmitted byte.

- A sequence of data (N-bytes + acknowledge)
- A stop condition (P)

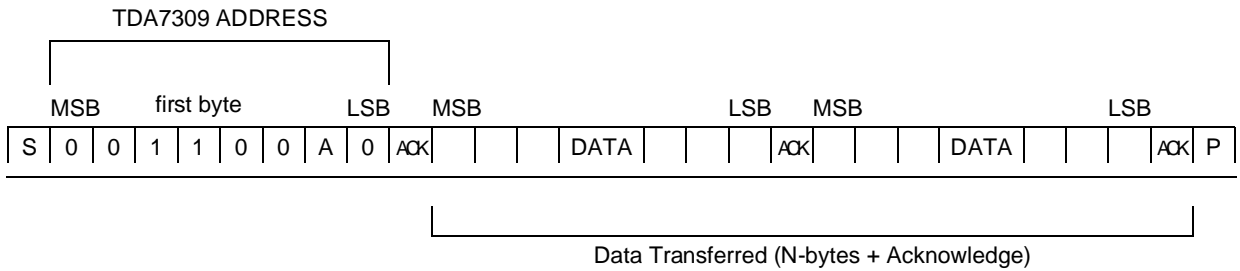

ACK = Acknowledge  
 S = Start  
 P = Stop

MAX CLOCK SPEED 100kbits/s

## SOFTWARE SPECIFICATION

Chip address

MSB				LSB				
0	0	1	1	0	0	1	0	pin address open
0	0	1	1	0	0	0	0	pin address close to ground

## FUNCTION CODES

	MSB	F6	F5	F4	F3	F2	F1	LSB
<b>VOLUME</b>	0	X	X	X	X	X	X	X
<b>MUTE/LOUD</b>	1	0	0	X	X	X	X	X
<b>INPUTS</b>	1	0	1	X	X	X	X	X
<b>CHANNEL</b>	1	1	0	X	X	X	X	X

## CHANNEL ABILITATION CODES

MSB	F6	F5	F4	F3	F2	F1	LSB	FUNCTION
1	1	0						channel
			X	X	X	0	0	RIGHT
			X	X	X	0	1	LEFT
			X	X	X	1	0	BOTH
			X	X	X	1	1	BOTH

## Power on reset condition

1 1 1 1 1 1 1 0



## VOLUME CODES

MSB	F6	F5	F4	F3	F2	F1	LSB	FUNCTION
0								step 1dB
					0	0	0	0dB
					0	0	1	-1dB
					0	1	0	-2dB
					0	1	1	-3dB
					1	0	0	-4dB
					1	0	1	-5dB
					1	1	0	-6dB
					1	1	1	-7dB
0								step 8dB
	0	0	0	0				0dB
	0	0	0	1				-8dB
	0	0	1	0				-16dB
	0	0	1	1				-24dB
	0	1	0	0				-32dB
	0	1	0	1				-40dB
	0	1	1	0				-48dB
	0	1	1	1				-56dB
	1	0	0	0				-64dB
	1	0	0	1				-72dB
	1	0	1	0				-80dB
	1	0	1	1				-88dB
	1	1	X	X				MUTE

## MUTE LOUDNESS CODES

MSB	F6	F5	F4	F3	F2	F1	LSB	FUNCTION
1	0	0						mute/loud
			X			0	0	slow soft mute on
			X			0	1	fast soft mute on
						1		soft mute off
					1			LOUD OFF
			X	0	0			loud on (10dB)
			X	1	0			loud on (20dB)

## INPUT MULTIPLEXER CODES

MSB	F6	F5	F4	F3	F2	F1	LSB	FUNCTION
1	0	1						inputs
			X	X	X	0	0	MUTE
			X	X	X	0	1	IN2
			X	X	X	1	0	IN3
			X	X	X	1	1	IN1

Purchase of I<sup>2</sup>C Components of SGS-THOMSON Microelectronics, conveys a license under the Philips I<sup>2</sup>C Patent Rights to use these components in an I<sup>2</sup>C system, provided that the system conforms to the I<sup>2</sup>C Standard Specifications as defined by Philips.

**OUTLINE AND MECHANICAL DATA**

DIM.	mm			inch		
	MIN.	TYP.	MAX.	MIN.	TYP.	MAX.
a1	0.254			0.010		
B	1.39		1.65	0.055		0.065
b		0.45			0.018	
b1		0.25			0.010	
D			25.4			1.000
E		8.5			0.335	
e		2.54			0.100	
e3		22.86			0.900	
F			7.1			0.280
I			3.93			0.155
L		3.3			0.130	
Z			1.34			0.053

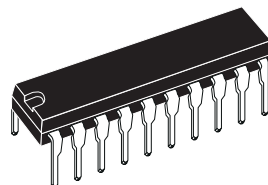

**DIP20**

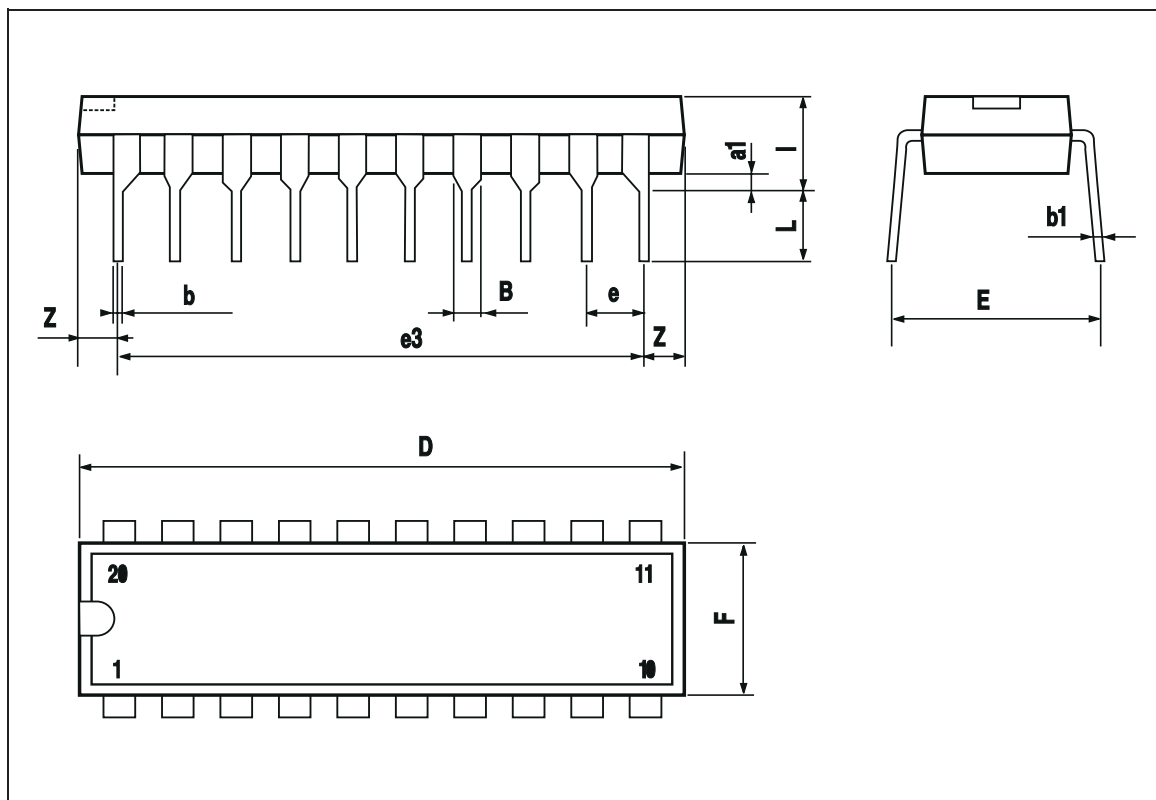

DIM.	mm			inch		
	MIN.	TYP.	MAX.	MIN.	TYP.	MAX.
A	2.35		2.65	0.093		0.104
A1	0.1		0.3	0.004		0.012
B	0.33		0.51	0.013		0.020
C	0.23		0.32	0.009		0.013
D	12.6		13	0.496		0.512
E	7.4		7.6	0.291		0.299
e		1.27			0.050	
H	10		10.65	0.394		0.419
h	0.25		0.75	0.010		0.030
L	0.4		1.27	0.016		0.050
K	0° (min.)8° (max.)					

**OUTLINE AND MECHANICAL DATA**

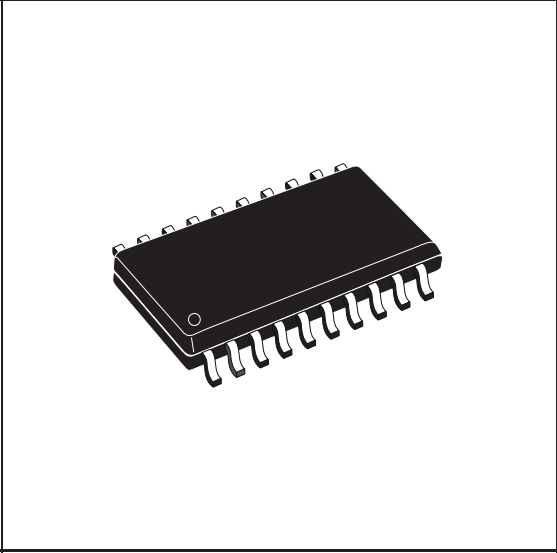

**SO20**

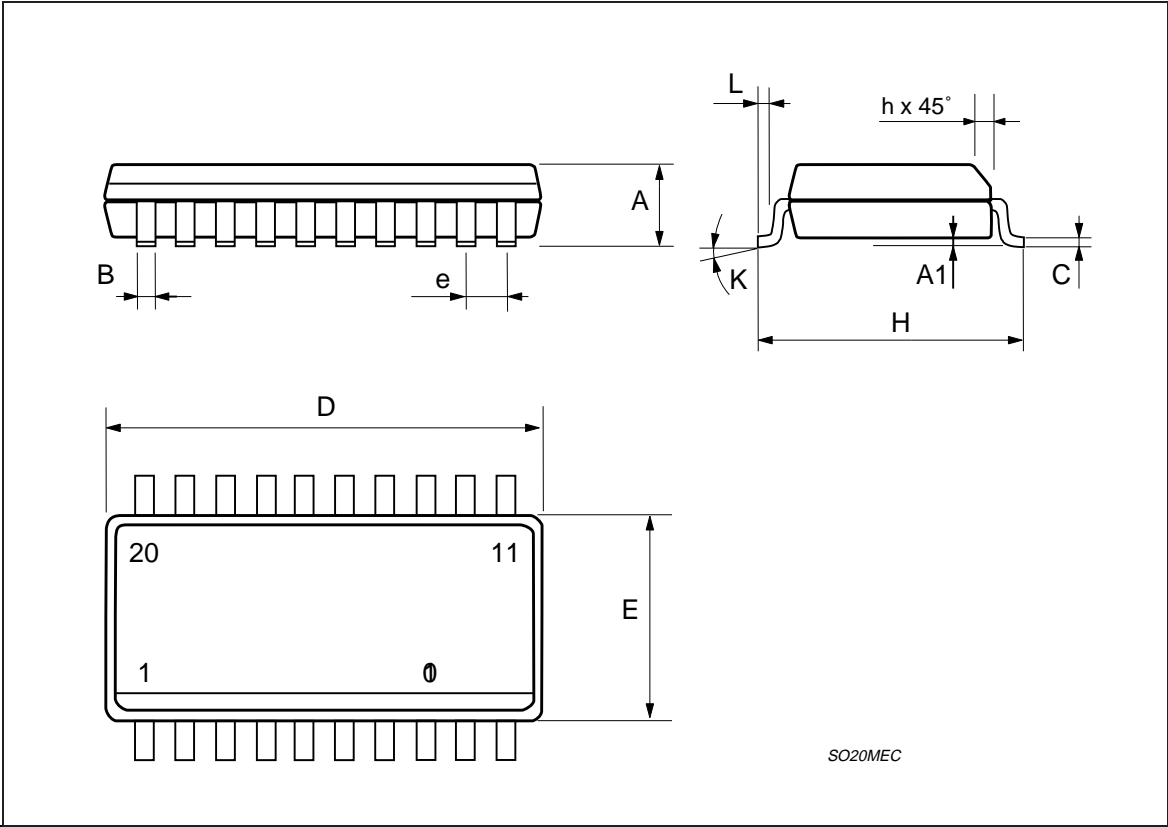

SO20MEC

Information furnished is believed to be accurate and reliable. However, STMicroelectronics assumes no responsibility for the consequences of use of such information nor for any infringement of patents or other rights of third parties which may result from its use. No license is granted by implication or otherwise under any patent or patent rights of STMicroelectronics. Specifications mentioned in this publication are subject to change without notice. This publication supersedes and replaces all information previously supplied. STMicroelectronics products are not authorized for use as critical components in life support devices or systems without express written approval of STMicroelectronics.

The ST logo is a registered trademark of STMicroelectronics.  
All other names are the property of their respective owners

© 2003 STMicroelectronics - All rights reserved

**STMicroelectronics GROUP OF COMPANIES**

Australia – Belgium - Brazil - Canada - China – Czech Republic - Finland - France - Germany - Hong Kong - India - Israel - Italy - Japan - Malaysia - Malta - Morocco - Singapore - Spain - Sweden - Switzerland - United Kingdom - United States

[www.st.com](http://www.st.com)