



53/63S3281/A 53S3281B

High Performance 4096 x 8 PROM TiW PROM Family

FEATURES/BENEFITS

- 35-ns maximum access time
- 32768-bit memory
- Reliable titanium-tungsten fuses (TiW) with programming yields typically greater than 98%
- PNP Inputs for low Input current

APPLICATIONS

- Microprogram control store
- Microprocessor program store
- Look-up table
- Character generator
- Code converter
- Programmable Logic Element (PLE™) with 12 Inputs, 8 Outputs and 4096 product terms

GENERAL DESCRIPTION

The 53/63S3281 is a high-speed 4Kx8 PROM which uses industry standard package and pin out.

The family features low-input current PNP inputs, full Schottky clamping, and three-state outputs. The Titanium-Tungsten fuses store a logical low and are programmed to the high state. Special on-chip circuitry

and extra fuses provide preprogramming tests which assure high programming yields and high reliability.

The 63 series is specified for operation over the commercial temperature and voltage range. The 53 series is specified for the military ranges.

PROGRAMMING

The 53/63S3281 PROM is programmed with the same programming algorithm as all other Advanced Micro

Devices generic TiW PROMs. For details contact the factory.

SELECTION GUIDE

Memory			Package		Performance	Part Number	
Size	Organization	Output	Pins	Type		0°C to +75°C	-55°C to +125°C
2K	256x8	TS	20	CD 020	Enhanced	63S281A	53S281A
				PD 020			
				CF 020	Standard	63S281	53S281
				CL 020			
				PL 020			

5

BLOCK DIAGRAM Dip Pinout

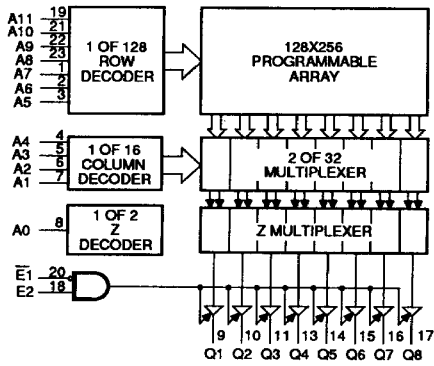

1312 01

PIN CONFIGURATIONS

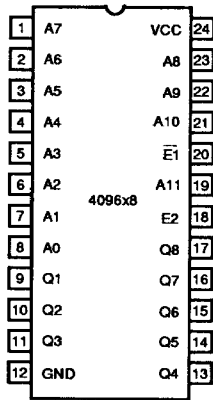

1312 02

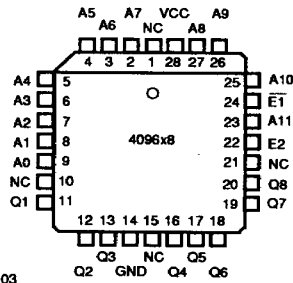

1312 03

Plastic Chip Carrier

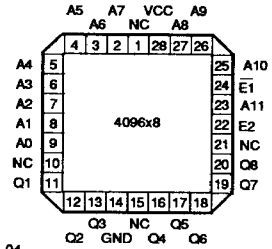

1312 04

Leadless Chip Carrier

ABSOLUTE MAXIMUM RATINGS

	Operating	Programming
Supply voltage V_{CC}	-0.5 V to 7 V	12 V
Input voltage	-1.5 V to 7 V	7 V
Input current	-30 mA to +5 mA	
Off-state output voltage	-0.5 V to 5.5 V	12 V
Storage temperature	-65°C to +150°C	

Stresses above those listed under "Absolute Maximum Ratings" may cause permanent damage to the device. This is a stress rating only, and functional operation of the device at these or any other conditions above those indicated in the operational sections of this specification is not implied. Exposure to Absolute Maximum Rating conditions for extended periods of time may affect reliability. Absolute Maximum Ratings are for system design reference; parameters given are not tested.

OPERATING CONDITIONS

Symbol	Parameter	Military†			Commercial			Unit
		Min.	Nom.	Max.	Min.	Nom.	Max.	
V_{CC}	Supply voltage	4.5	5	5.5	4.75	5	5.25	V
T_A	Operating temperature*	-55		125	0		75	°C

* This is defined as the instant-on case temperature.*

† Military burn-in is in accordance with the current revision of MIL-STD-883, Test Method 1015, Conditions A through E. Test conditions are selected at AMD's option.

Electrical Characteristics Over Operating Conditions. For APL products, Group A, Subgroups 1, 2, 3 are tested unless otherwise noted.

Symbol	Parameter	Test Condition		Min	Typ†	Max	Unit
V_{IL}	Low-level input voltage**					0.8	V
V_{IH}	High-level input voltage**			2			V
V_{IC}	Input clamp voltage	$V_{CC} = \text{MIN}$	$I_I = -18 \text{ mA}$			-1.5	V
I_{IL}	Low-level input current	$V_{CC} = \text{MAX}$	$V_I = 0.4 \text{ V}$			-0.25	mA
I_{IH}	High-level input current	$V_{CC} = \text{MAX}$	$V_I = V_{CC} \text{ MAX}$			40	μA
V_{OL}	Low-level output voltage	$V_{CC} = \text{MIN}$	$I_{OL} = 16 \text{ mA}$	Com		0.45	V
				Mil		0.5	
V_{OH}	High-level output voltage	$V_{CC} = \text{MIN}$	Com	$I_{OH} = -3.2 \text{ mA}$	2.4		V
			Mil	$I_{OH} = -2 \text{ mA}$			
I_{OZL}	Off-state output current	$V_{CC} = \text{MAX}$	$V_O = 0.4 \text{ V}$				-40
I_{OZH}			$V_O = 2.4 \text{ V}$				40
I_{OS}	Output short-circuit current*	$V_{CC} = 5 \text{ V}$	$V_O = 0 \text{ V}$		-20		-90
I_{CC}	Supply current	$V_{CC} = \text{MAX}$. All inputs grounded. All outputs open.				150	190

* Not more than one output should be shorted at a time and duration of the short-circuit should not exceed one second.

** V_{IL} and V_{IH} are input conditions of output tests and are not themselves directly tested. V_{IL} and V_{IH} are absolute voltages with respect to device ground and include all overshoots due to system and/or tester noise. Do not attempt to test these values without suitable equipment.

Switching Characteristics Over Operating Conditions (See standard test load). For APL products, Group A, Subgroups 9, 10, 11 are tested unless otherwise noted.^{††}

Operating Conditions	Device Type	t_{AA} (ns) Address Access Time		t_{EA} and t_{ER} (ns) Enable Access time Recovery time		Unit
		Typ†	Max	Typ†	Max	
Commercial	63S3281A	26	35	18	30	ns
	63S3281	26	45	18	30	
Military	53S3281B	26	40	18	35	
	53S3281A	26	50	18	35	
	53S3281	26	60	18	35	

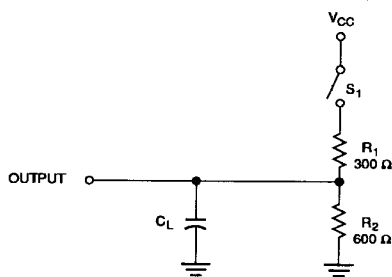

† Typicals at 5.0 V V_{CC} and 25°C T_A .

†† Subgroups 7 and 8 apply to functional tests.



1312 07

Figure 1. Switching Test Load

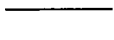
WAVEFORM	INPUTS	OUTPUTS
	DON'T CARE: CHANGE PERMITTED	CHANGING: STATE UNKNOWN
	NOT APPLICABLE	CENTER LINE IS HIGH IMPEDANCE STATE
	MUST BE STEADY	WILL BE STEADY

1312 08

Figure 2. Definition of Timing Diagram

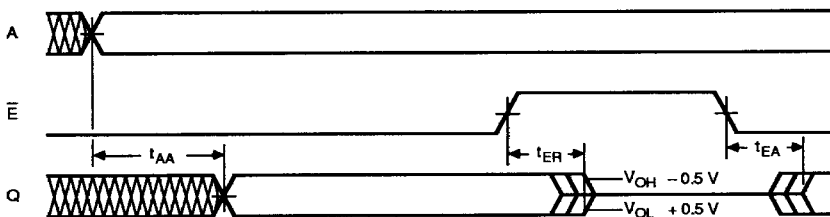

- NOTES:
1. INPUT PULSE AMPLITUDE 0 V TO 3.0 V.
 2. INPUT RISE AND FALL TIMES 2–5 ns FROM 0.8 V TO 2.0 V.
 3. INPUT ACCESS MEASURED AT THE 1.5 V LEVEL.
 4. t_{AA} IS TESTED WITH SWITCH S_1 CLOSED. $C_L = 30$ pF AND MEASURED AT 1.5 V OUTPUT LEVEL.
 5. t_{EA} IS MEASURED AT THE 1.5 V OUTPUT LEVEL WITH $C_L = 30$ pF. S_1 IS OPEN FOR HIGH IMPEDANCE TO "1" TEST, AND CLOSED FOR HIGH IMPEDANCE "0" TEST.
 t_{ER} IS TESTED WITH $C_L = 5$ pF. S_1 IS OPEN FOR "1" TO HIGH IMPEDANCE TEST, MEASURED AT $V_{OH} = -0.5 V$ OUTPUT LEVEL;
 S_1 IS CLOSED FOR "0" TO HIGH IMPEDANCE TEST, MEASURED AT $V_{OL} = +0.5 V$ OUTPUT LEVEL.

1312 09

Figure 3. Definition of Waveforms