



Ultra High Performance BGA Cooling Solutions w/ Thermal Tape Attachment

ATS PART # ATS-52230B-C2-R0

Features & Benefits

- » maxiFLOW™ design features a low profile, spread fin array that maximizes surface area for more effective convection (air) cooling
- » Fabricated from extruded aluminum, which minimizes thermal resistance from the base to the fins, reduces weight and keeps costs low
- » Higher performance helps ensure reliable product life at a lower cost than other extruded heat sinks

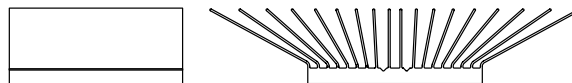
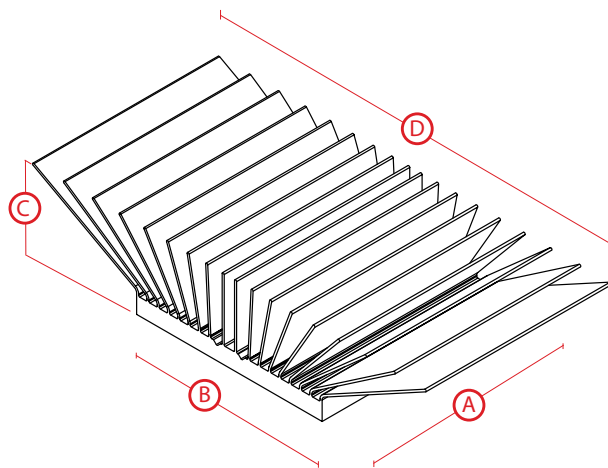

**Image above is for illustration purposes only.*

Thermal Performance

AIR VELOCITY		THERMAL RESISTANCE	
FT/MIN	M/S	°C/W (UNDUCTED FLOW)	°C/W (DUCTED FLOW)
200	1.0	10.9	8.3
300	1.5	8.7	
400	2.0	7.5	
500	2.5	6.7	
600	3.0	6.2	
700	3.5	5.7	
800	4.0	5.3	

Product Details

DIMENSION A	DIMENSION B	DIMENSION C	DIMENSION D	INTERFACE MATERIAL	FINISH
23 mm	23 mm	7.5 mm	37.5 mm	SAINT-GOBAIN C675	BLUE-ANODIZED

NOTES:

- 1) Dimension C = heat sink height from bottom of the base to the top of the fin field.
- 2) Thermal performance data are provided for reference only. Actual performance may vary by application.
- 3) ATS reserves the right to update or change its products without notice to improve the design or performance.
- 4) Contact ATS to learn about custom options available.



ATS ADVANCED
THERMAL
SOLUTIONS, INC.
Innovations in Thermal Management®

For more information, to find a distributor or to place an order, visit www.qats.com or call: 781.769.2800 (North America); +31 (0) 3569 84715 (Europe).