



**DB LECTRO**<sup>INC</sup>  
*COMPOSANTS ÉLECTRONIQUES*  
*ELECTRONIC COMPONENTS*

**RM.RMR Series** Surface Mounting Type Dip Switch



**RoHS Compliant**

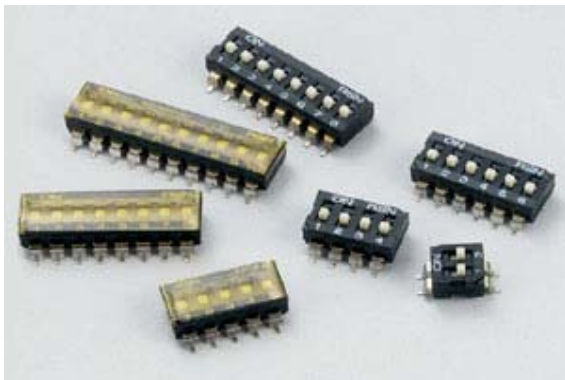

**RM SERIES**

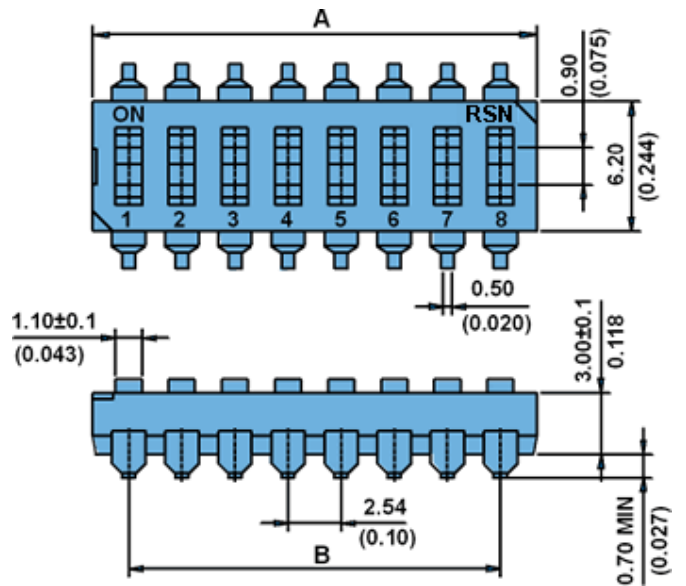

**RM & RMR CONSTRUCTION**

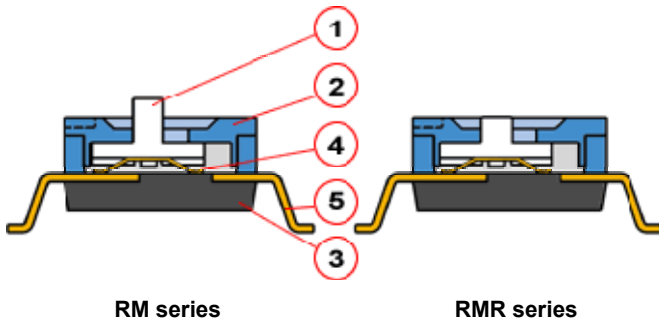

**P.C.B. LAYOUT**

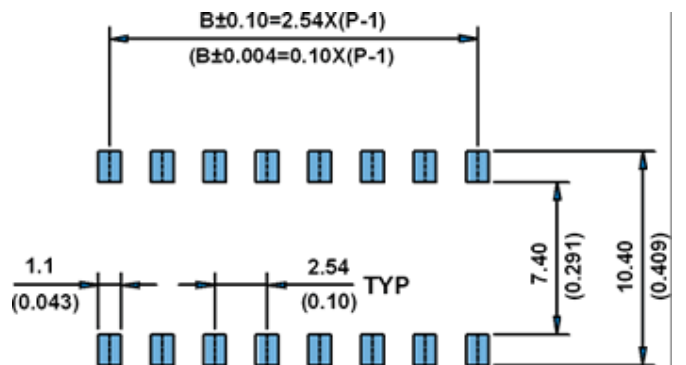

1. RM series (raised actuator) and RMR series (recessed actuator) available for different purposes.
2. Low contact resistance, and self-clean on contact area.
3. Gold plated electrical contact and terminal plating by gold give excellent results when soldering.
4. Double contacts offer high reliability.
5. All materials are UL94V-0 grade fire retardant plastics.

**CIRCUIT DIAGRAM**

ITEM	Description	Materials	Treatment
1	Actuator	UL94V-0 Nylon	Molded white
2	Cover	UL94V-0 Nylon	Molded black
3	Base	UL94V-0 Nylon	Molded black
4	Contact	Beryllium Copper	Gold plated at contact area
5	Terminal	Brass	Gold plated at contact area

# DB LECTRO<sub>U</sub><sub>Z</sub>

## MODEL

PROD NO.	NO. OF POS	DIM A	
RM/RMR-01	01	3.48	0.137
RM/RMR-02	02	6.02	0.237
RM/RMR-03	03	8.56	0.337
RM/RMR-04	04	11.1	0.437
RM/RMR-05	05	13.64	0.537
RM/RMR-06	06	16.18	0.637
RM/RMR-07	07	18.72	0.737
RM/RMR-08	08	21.26	0.837
RM/RMR-09	09	23.8	0.937
RM/RMR-10	10	26.34	1.037
RM/RMR-12	12	31.42	1.237

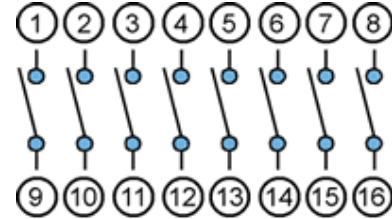

## TERMINAL TYPE

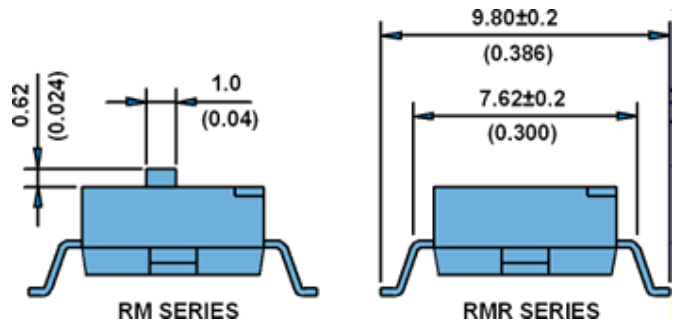

Tape & reel packing (Per EIA standards)  
For packing details, please refer to pages 13

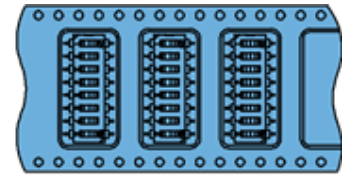

## HOW TO ORDER

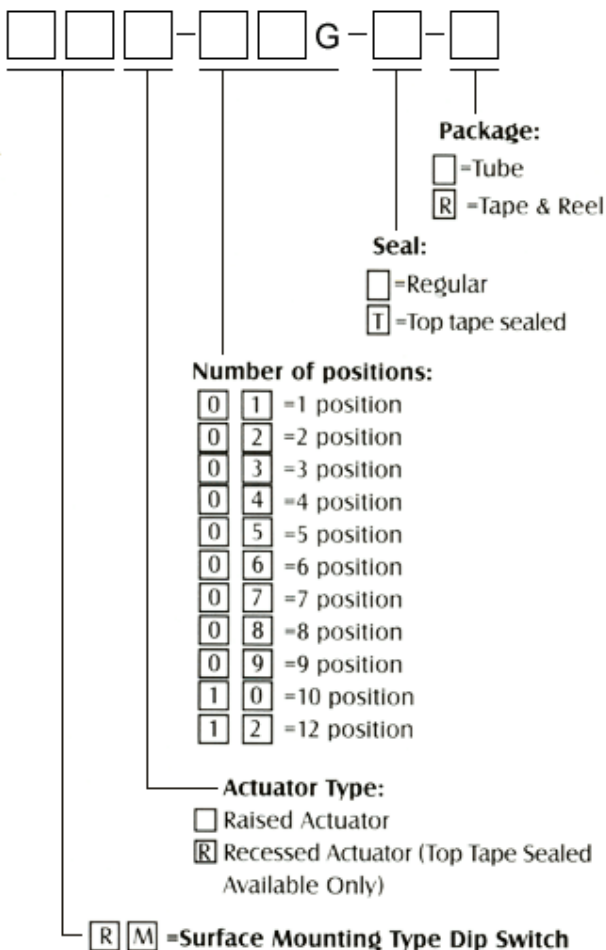

## SPECIFICATION

### ELECTRICAL

Electrical life: 2000 operation cycles per switch 24VDC, 25mA.  
 Non-Switching Rating: 100mA, 50 VDC  
 Switching Rating: 25mA, 24VDC.  
 Contact resistance: (a) 50mΩ max. at initial  
 (b) 100mΩ max. after life test.  
 Insulation resistance: 100MΩ min. (at 500VDC)  
 Dielectric Strength: 500VAC/1 minute.  
 Capacitance: 5pF max.  
 Circuit: Single pole single throw

### MECHANICAL

Mechanical life: 2000 operations per cycle switch  
 Operation Force: 600gf max.  
 Stroke: 0.9mm  
 Operation Temp: -25° C to +70° C  
 Storage Temp: -40° C to +85° C  
 Vibration Test: MIL-STD-202F METHOD 201A  
 Frequency: 10-55-10Hz/1 min  
 Directions: X, Y, Z, three mutually perpendicular directions.  
 Time: 2 hours each direction.  
 High reliability.

Shock Test: MIL-STD-202F METHOD 213B.

### CONDITION A

GRAVITY: 50G (peak value), 11 m/sec.  
 Direction and times: 6 sides and three times in each direction. High reliability.

**Example:** RMR-08G-T is a surface mounting Type Dip Switch, Recessed Actuator 8 position, with, top tape sealed.

# DB LECTRO<sup>U</sup><sub>Z</sub>

**PACKING** All DIP switches are shipped in standard IC tubes or Tape & Reel Package with all poles in the "OFF" position.

## CARRIER TAPE PACKING

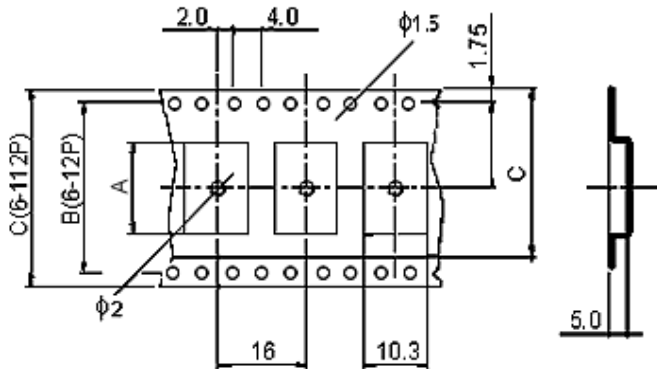

PART NO.	NO. OF POS	A	B	C	Q'TY/REEL
RMR-02G-T-R	02	6.50	5.5	16	800 pcs
RMR-03G-T-R	03	9.00	7.5	16	800 pcs
RMR-04G-T-R	04	11.50	11.5	24	800 pcs
RMR-05G-T-R	05	14.10	11.5	24	800 pcs
RMR-06G-T-R	06	16.60	14.2	32	800 pcs
RMR-07G-T-R	07	19.10	14.2	32	800 pcs
RMR-08G-T-R	08	21.70	14.2	32	800 pcs
RMR-09G-T-R	09	24.20	20.2	44	800 pcs
RMR-10G-T-R	10	26.70	20.2	44	800 pcs
RMR-12G-T-R	12	31.90	20.2	44	800 pcs

## SOLDERING AND CLEANING PROCESSES

For best results, please follow these recommendations: Keep all switch contacts in their "OFF" position for all operations.

Soldering: vapor phase & IR-reflow soldering can be applied.  
 CLEANING PROCESS: Flux clean using force rinse, high agitation or triple bath cleaning method. Freon TF or TE give excellent results. When vapor methods are used, do not subject the switch to solvents at temperatures above 125 F (51° C).

## Reflow Temperature Profile. (reference)

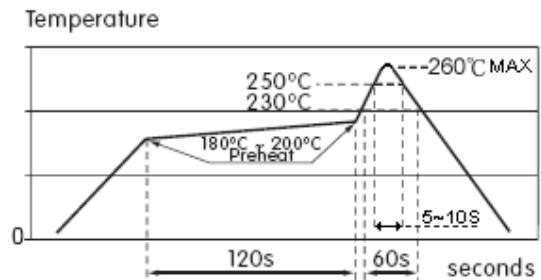

## CARRIER TAPE PACKING

