

Silicon Schottky Diode

- General-purpose diode for high-speed switching
- Circuit protection
- Voltage clamping
- High-level detecting and mixing

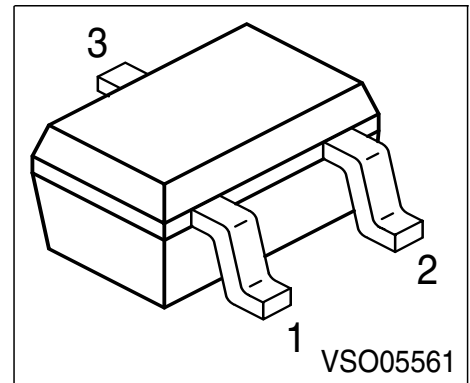

BAS 40-04W

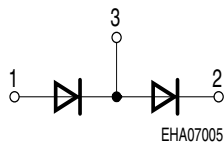

BAS 40-05W

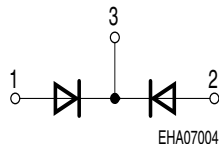

BAS 40-06W

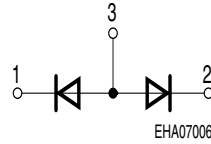

Type	Marking	Pin Configuration			Package
BAS 40-04W	44s	1 = A1	2 = C2	3=C1/A2	SOT-323
BAS 40-05W	45s	1 = A1	2 = A2	3=C1/C2	SOT-323
BAS 40-06W	46s	1 = C1	2 = C2	3=A1/A2	SOT-323

Maximum Ratings

Parameter	Symbol	Value	Unit
Diode reverse voltage	V_R	40	V
Forward current	I_F	120	mA
Surge forward current, $t \leq 10\text{ms}$	I_{FSM}	200	
Total power dissipation, $T_S \leq 106^\circ\text{C}$	P_{tot}	250	mW
Junction temperature	T_j	150	°C
Operating temperature range	T_{op}	-55 ... 150	
Storage temperature	T_{stg}	-55 ... 150	

Maximum Ratings

Junction - ambient ¹⁾	R_{thJA}	≤ 395	K/W
Junction - soldering point	R_{thJS}	≤ 175	

1) Package mounted on epoxy pcb 40mm x 40mm x 1.5mm / 1cm² Cu

Electrical Characteristics at $T_A = 25^\circ\text{C}$, unless otherwise specified.

Parameter	Symbol	Values			Unit
		min.	typ.	max.	
DC characteristics					
Breakdown voltage $I_{(BR)} = 10 \mu\text{A}$	$V_{(BR)}$	40	-	-	V
Reverse current $V_R = 30 \text{ V}$ $V_R = 40 \text{ V}$	I_R	- -	- -	1 10	μA
Forward voltage $I_F = 1 \text{ mA}$ $I_F = 10 \text{ mA}$ $I_F = 15 \text{ mA}$	V_F	250 350 600	310 450 720	380 500 1000	mV
AC characteristics					
Diode capacitance $V_R = 0 \text{ V}, f = 1 \text{ MHz}$	C_T	-	3	5	pF
Charge carrier life time $I_F = 25 \text{ mA}$	τ	-	10	-	ps
Differential forward resistance $I_F = 10 \text{ mA}, f = 10 \text{ kHz}$	R_F	-	10	-	Ω
Series inductance	L_S	-	2	-	nH

Forward current $I_F = f(V_F)$

$T_A = 25^\circ\text{C}$

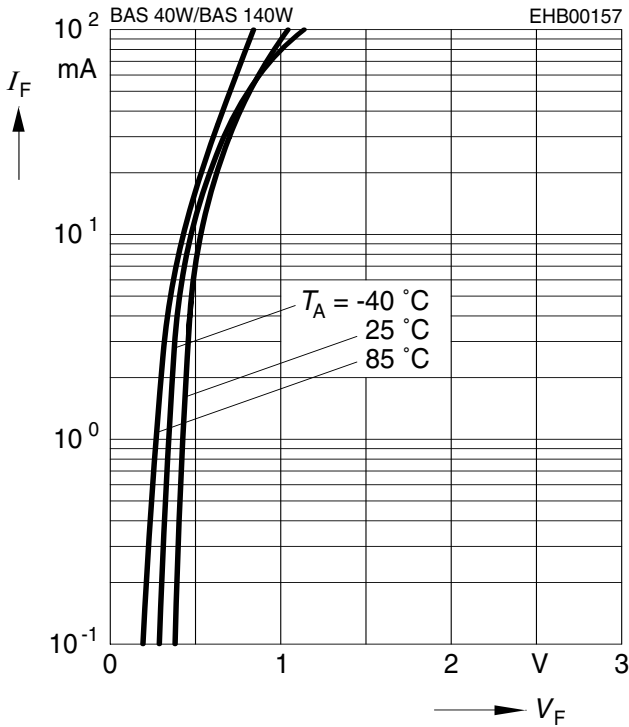

Reverse current $I_R = f(V_R)$

$T_A = \text{Parameter}$

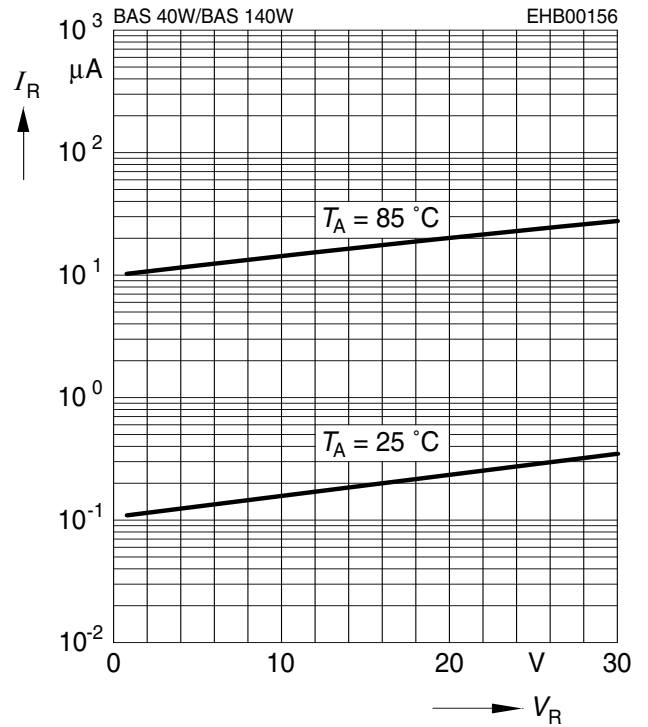

Diode capacitance $C_T = f(V_R)$

$f = 1\text{MHz}$

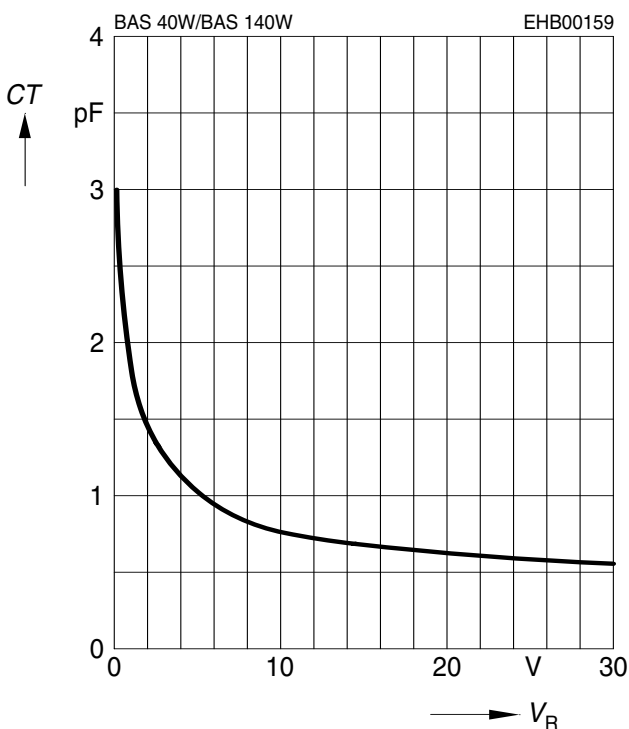

Differential forward resistance $r_f = f(I_F)$

$f = 10\text{kHz}$

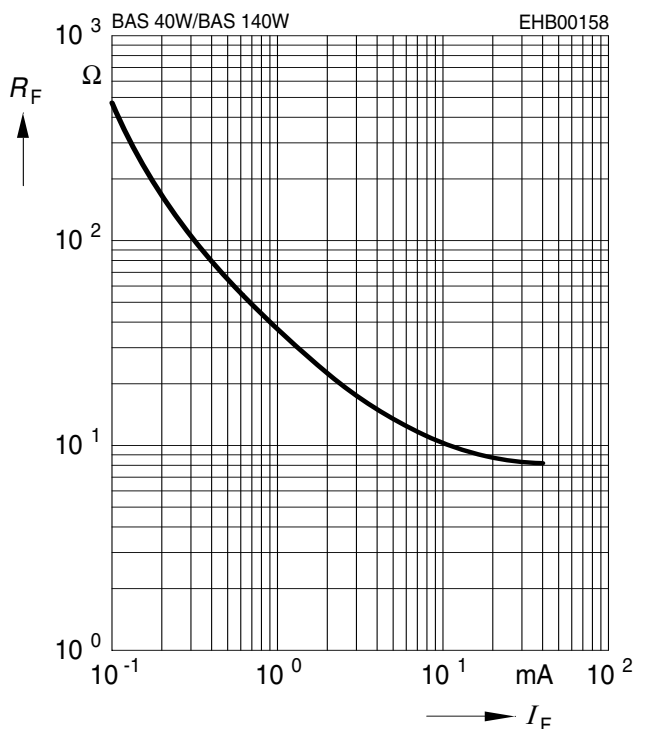

Forward current $I_F = f(T_A^*; T_S)$

* Package mounted on epoxy

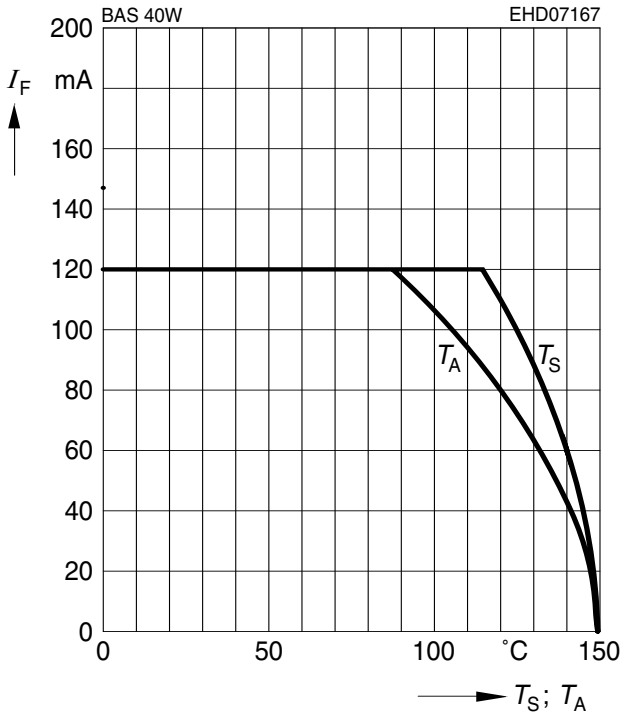

Permissible pulse load $R_{thJS} = f(t_p)$

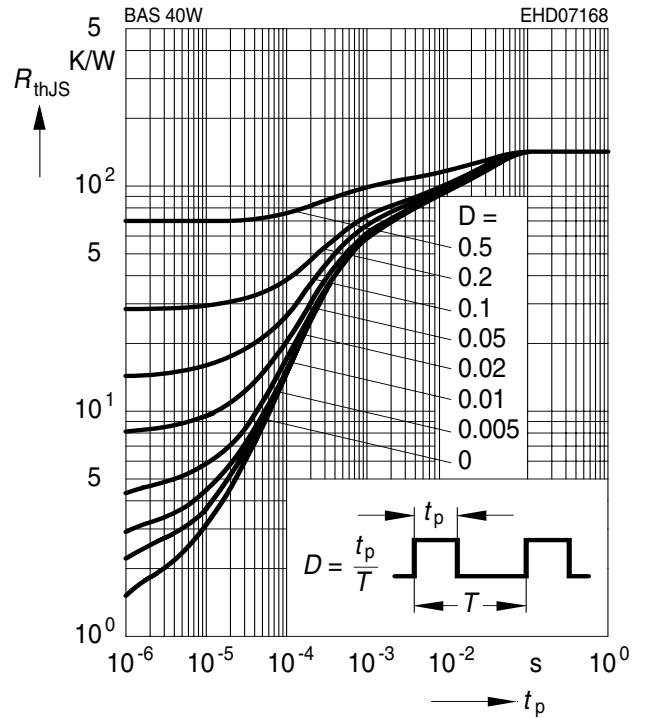

Permissible pulse load $I_{Fmax} / I_{FDC} = f(t_p)$

