

**Features**

- Third Generation Programmable Logic Structure  
High Density Replacement for Discrete Logic
- High Speed - Plus a New Low Power Version
- Increased Logic Flexibility  
42 Inputs and 20 Sum terms
- Flexible Output Logic  
20 Flip-Flops - 10 Extra  
All Can Be Individually Buried or 10 Output Directly  
Each has Individual Asynchronous Reset and Clock Terms
- Multiple Feedback Paths Provide for Buried State Machines and I/O Bus Compatibility
- Proven and Reliable High Speed CMOS EPROM Process  
2000 V ESD Protection  
200 mA Latchup Immunity
- Reprogrammable - Tested 100% for Programmability
- 24-pin, 300-mil Dual-in-line and 28-Lead Surface Mount Packages

**High Density  
UV Erasable  
Programmable  
Logic Device**

**Logic Diagram**

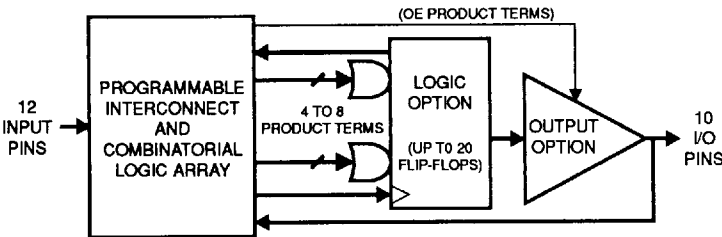

**Description**

The ATV750/L is 100% more powerful than most other programmable logic devices in 24-pin packages. Increased product terms, sum terms, and flip-flops translate into more usable gates.

Each of the ATV750's 22 logic pins can be used as an input. Ten of these can be used as input, output, or bi-directional I/O pins. All 20 flip-flops can be fed back into the array independently. This flexibility allows burying all of the sum terms and flip-flops.

There are 171 product terms available. A variable format is used to assign between four and eight product terms per sum term. There are two sum terms per output, providing added flexibility.

The ATV750/L has more flip-flops available than other PLDs in this density range. Complex state machines are easily implemented.

Product terms are available providing asynchronous resets, flip-flop clocks, and output enables. One reset and one clock term are provided per flip-flop, with one enable term per output. One product term provides a global synchronous preset. Register preload simplifies testing. The device has an internal power up clear function.

**Pin Configurations**

Pin Name	Function
IN	Logic Inputs
I/O	Bidirectional Buffers
*	No Internal Connection
Vcc	+5V Supply

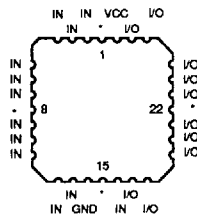
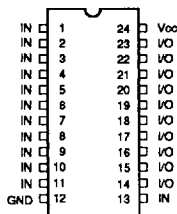

## Absolute Maximum Ratings\*

Temperature Under Bias.....	-55°C to +125°C
Storage Temperature.....	-65°C to +150°C
Voltage on Any Pin with Respect to Ground.....	-2.0 V to +7.0 V <sup>(1)</sup>
Voltage on Input Pins with Respect to Ground During Programming.....	-2.0 V to +14.0 V <sup>(1)</sup>
Programming Voltage with Respect to Ground.....	-2.0 V to +14.0 V <sup>(1)</sup>
Integrated UV Erase Dose.....	7258 W. sec/cm <sup>2</sup>

\*NOTICE: Stresses beyond those listed under "Absolute Maximum Ratings" may cause permanent damage to the device. This is a stress rating only and functional operation of the device at these or any other conditions beyond those indicated in the operational sections of this specification is not implied. Exposure to absolute maximum rating conditions for extended periods may affect device reliability.

**Note:**

1. Minimum voltage is -0.6 V dc which may undershoot to -2.0 V for pulses of less than 20 ns. Maximum output pin voltage is V<sub>CC</sub>+0.75 V dc which may overshoot to +7.0 V for pulses of less than 20 ns.

## Logic Options

Combined Terms

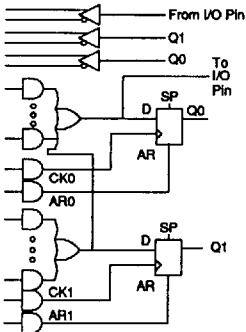

Separate Terms

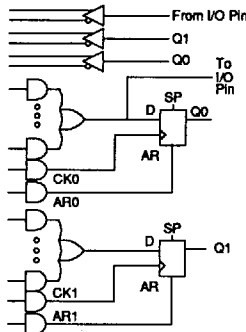

Combined Terms

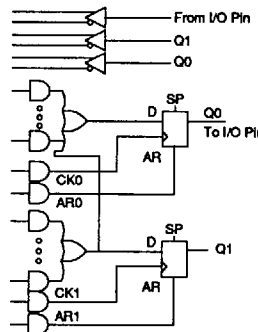

Separate Terms

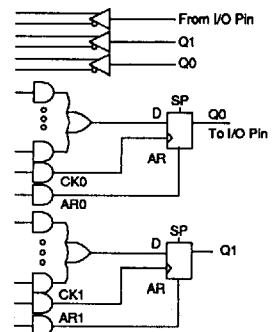

## Output Options

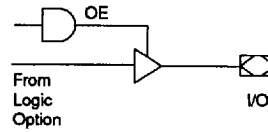
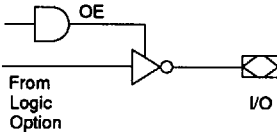

## D.C. and A.C. Operating Conditions

		ATV750-20	ATV750/L-25	ATV750/L-30	ATV750-35
Operating Temperature (Case)	Com.	0°C - 70°C	0°C - 70°C	0°C - 70°C	0°C - 70°C
	Ind.	-40°C - 85°C	-40°C - 85°C	-40°C - 85°C	-40°C - 85°C
	Mil.	-55°C - 125°C	-55°C - 125°C	-55°C - 125°C	-55°C - 125°C
V <sub>CC</sub> Power Supply		5 V ± 10%	5 V ± 10%	5 V ± 10%	5 V ± 10%

## D.C. Characteristics

Symbol	Parameter	Condition	Min	Typ	Max	Units	
$I_{LI}$	Input Load Current	$V_{IN} = -0.1 \text{ V to } V_{CC}+1 \text{ V}$			10	$\mu\text{A}$	
$I_{LO}$	Output Leakage Current	$V_{OUT} = -0.1 \text{ V to } V_{CC}+0.1 \text{ V}$			10	$\mu\text{A}$	
$I_{CC}$	Power Supply Current	$V_{CC} = \text{MAX, } V_{IN} = \text{GND, Outputs Open}$	ATV750	Com.		120	$\text{mA}$
				Ind.,Mil.		140	$\text{mA}$
			ATV750L	Com.	1.0	12	$\text{mA}$
				Ind.,Mil.	1.0	15	$\text{mA}$
$I_{CC2}^{(2)}$	Clocked Power Supply Current	$f = 1\text{MHz, } V_{CC} = \text{MAX, Outputs Open}$	ATV750L	Com.		15	$\text{mA}$
				Ind.,Mil.		20	$\text{mA}$
$I_{OS}^{(1)}$	Output Short Circuit Current	$V_{OUT} = 0.5 \text{ V}$			-90	$\text{mA}$	
$V_{IL}$	Input Low Voltage		-0.6		0.8	$\text{V}$	
$V_{IH}$	Input High Voltage		2.0		$V_{CC}+0.75$	$\text{V}$	
$V_{OL}$	Output Low Voltage	$V_{IN} = V_{IH} \text{ or } V_{IL, } V_{CC} = \text{MIN}$	IOL = 12 mA Com.,Ind.		0.5	$\text{V}$	
			IOL = 8 mA Mil.		0.5	$\text{V}$	
			IOL = 24 mA, Com.		1.0	$\text{V}$	
$V_{OH}$	Output High Voltage	$V_{IN} = V_{IH} \text{ or } V_{IL, } V_{CC} = \text{MIN}$	IOH = -100 $\mu\text{A}$		$V_{CC}-0.3$	$\text{V}$	
			IOH = -4.0 mA		2.4	$\text{V}$	

Notes: 1. Not more than one output at a time should be shorted. Duration of short circuit test should not exceed 30 sec.  
 2. Outputs not loaded.

## Operating Modes

Mode	24-Pin DIP	1	5	8	11	13	I/Os	$V_{CC} (24)$
	28-Pin JLC	2	6	10	13	16	I/Os	$V_{CC} (28)$
"PLD"		X <sup>(1)</sup>	X	X	X	X	I/O	5V
Program		$V_{PP}$	X/ $V_H$ <sup>(2)</sup>	X	X/ $V_H$	$V_{PP}$	DIN	6V
PGMVerify		$V_{PP}$	X/ $V_H$	X	X/ $V_H$	$V_{IL}$	DOUT	5V
PGM Inhibit		$V_{PP}$	X/ $V_H$	X	X/ $V_H$	$V_{IH}$	High Z	5-6V
Preload #1		X	X	$V_H$	X	$V_{IL}$	DIN	5V
Preload #2		X	X	$V_H$	X	$V_{IH}$	DIN	5V

Notes: 1. X can be  $V_{IL}$  or  $V_{IH}$ .  
 2.  $V_H = 11.0 \text{ V to } 14.0 \text{ V}$





## A.C. Waveforms <sup>(1)</sup>

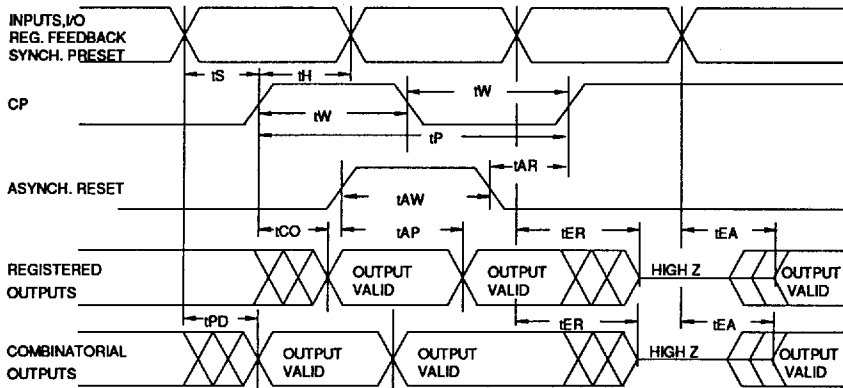

Note: 1. Timing measurement reference is 1.5 V. Input AC driving levels are 0.0 V and 3.0 V, unless otherwise specified.

## A.C. Characteristics

Symbol	Parameter	ATV750-30		ATV750-35		Units
		Min	Max	Min	Max	
t <sub>PD</sub>	Input or Feedback to Non-Registered Output		30		35	ns
t <sub>EA</sub>	Input to Output Enable		30		35	ns
t <sub>ER</sub>	Input to Output Disable		30		35	ns
t <sub>CO</sub>	Clock to Output	5	25	10	30	ns
t <sub>CF</sub>	Clock to Feedback	5	10	10	12	ns
t <sub>S</sub>	Input Setup Time	15		18		ns
t <sub>H</sub>	Hold Time	5		10		ns
t <sub>P</sub>	Clock Period	25		30		ns
t <sub>W</sub>	Clock Width	12		15		ns
f <sub>MAX</sub>	Maximum Frequency		40		33	MHz
t <sub>AW</sub>	Asynchronous Reset Width	30		35		ns
t <sub>AR</sub>	Asynchronous Reset Recovery Time	30		35		ns
t <sub>AP</sub>	Asynchronous Reset to Registered Output Reset		30		35	ns
t <sub>SP</sub>	Setup Time, Synchronous Preset	15		18		ns

## A.C. Characteristics

Symbol	Parameter	ATV750-20		ATV750/L-25		ATV750L-30		Units
		Min	Max	Min	Max	Min	Max	
t <sub>PD</sub>	Input or Feedback to Non-Registered Output		20		25		30	ns
t <sub>EA</sub>	Input to Output Enable		20		25		30	ns
t <sub>ER</sub>	Input to Output Disable		20		25		30	ns
t <sub>CO</sub>	Clock to Output		20		22	5	25	ns
t <sub>CF</sub>	Clock to Feedback	5	10	5	10	5	10	ns
t <sub>S</sub>	Input Setup Time	10		12		15		ns
t <sub>SF</sub>	Feedback Setup Time	5		7		15		ns
t <sub>H</sub>	Hold Time	5		5		5		ns
t <sub>P</sub>	Clock Period	18		22		25		ns
t <sub>W</sub>	Clock Width	8		10		12		ns
F <sub>MAX</sub>	Maximum Frequency		55		45		40	MHz
t <sub>AW</sub>	Asynchronous Reset Width	15		20		30		ns
t <sub>AR</sub>	Asynchronous Reset Recovery Time	15		20		30		ns
t <sub>AP</sub>	Asynchronous Reset to Registered Output Reset		20		25		30	ns
t <sub>SP</sub>	Setup Time, Synchronous Preset	12		15		15		ns

### Input Test Waveforms and Measurement Levels

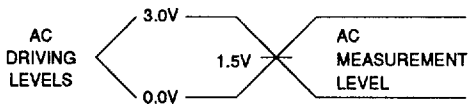

t<sub>R</sub>, t<sub>F</sub> < 5 ns (10% to 90%)

### Output Test Load

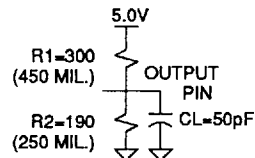

# Functional Logic Diagram ATV750, Upper Half

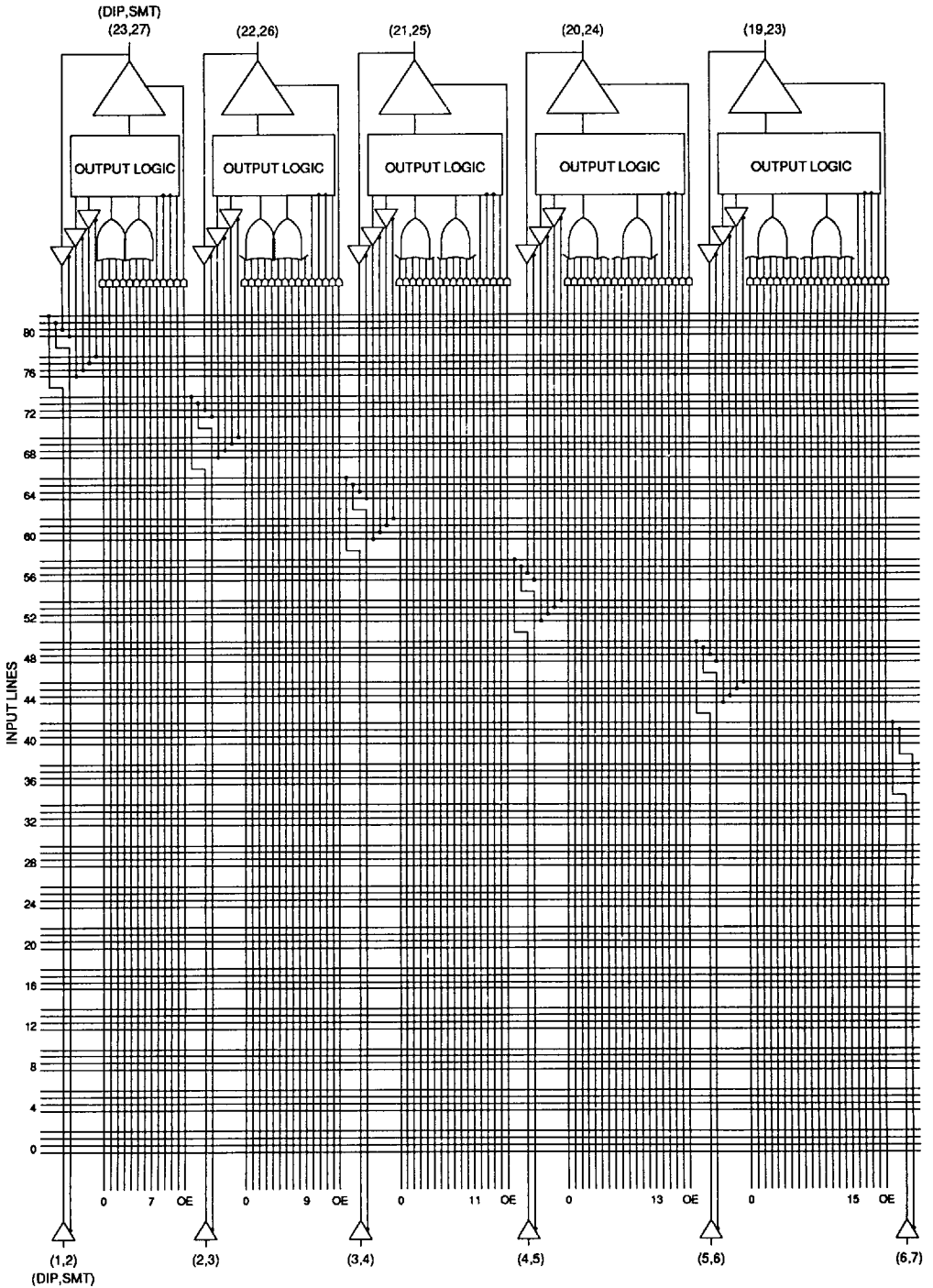

Functional Logic Diagram ATV750, Lower Half

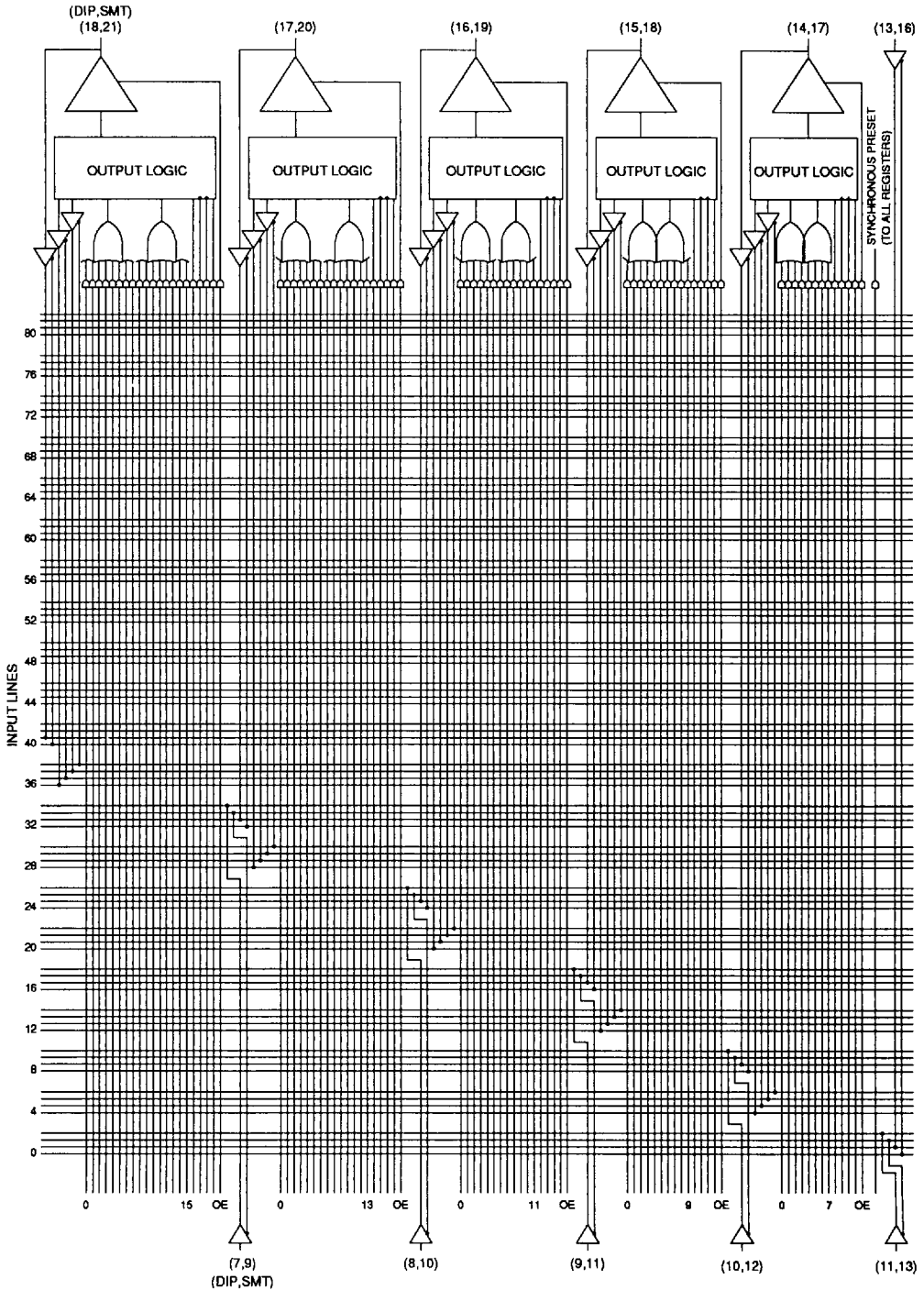

1



## Preload of Registered Outputs

The ATV750's registers are provided with circuitry to allow loading of each register asynchronously with either a high or a low. This feature will simplify testing since any state can be forced into the registers to control test sequencing. A  $V_{IH}$  level on the I/O pin will force the register high; a  $V_{IL}$  will

force it low, independent of the output polarity. The preload state is entered by placing an 11 V to 14 V signal on pin 8 on DIPs, and pin 10 on SMPs. When the clock term is pulsed high, the data on the I/O pin is placed into the register chosen by the Select Pin.

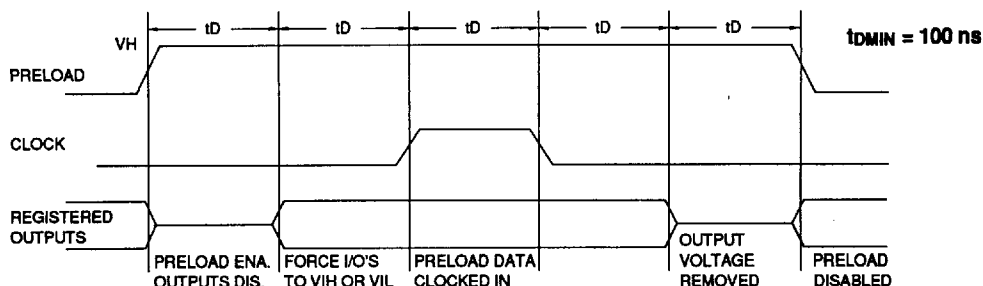

Level forced on registered output pin during PRELOAD cycle	Select Pin State	Register #1 state after cycle	Register #2 State after cycle
$V_{IH}$	Low	High	X
$V_{IL}$	Low	Low	X
$V_{IH}$	High	X	High
$V_{IL}$	High	X	Low

## Power Up Reset

The registers in the ATV750/L are designed to reset during power up. At a point delayed slightly from  $V_{CC}$  crossing 3.8 V, all registers will be reset to the low state. The output state will depend on the polarity of the output buffer.

This feature is critical for state machine initialization. However, due to the asynchronous nature of reset and the uncertainty of how  $V_{CC}$  actually rises in the system, the following conditions are required:

- 1) The  $V_{CC}$  rise must be monotonic,
- 2) After reset occurs, all input and feedback setup times must be met before driving the clock term high, and
- 3) The signals from which the clock is derived must remain stable during  $t_{PR}$ .

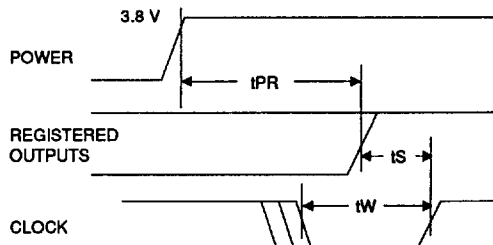

Parameter	Description	Min	Typ	Max	Units
$t_{PR}$	Power-Up ResetTime		600	1000	ns

## Pin Capacitance ( $f = 1 \text{ MHz}$ , $T = 25^\circ\text{C}$ )<sup>(1)</sup>

	Typ	Max	Units	Conditions
$C_{IN}$	5	8	pF	$V_{IN} = 0 \text{ V}$
$C_{OUT}$	6	8	pF	$V_{OUT} = 0 \text{ V}$

Note: 1. Typical values for nominal supply voltage. This parameter is only sampled and is not 100% tested.



## Using the ATV750's Many Advanced Features

The ATV750's flexibility puts more usable gates in 24 pins than other PLDs. The ATV750/L starts with an architecture similar to the popular AT22V10, and adds several features:

- **Asynchronous Clocks** - Each of the flip-flops in the ATV750/L has a dedicated product term driving the clock. The user is no longer constrained to using one clock for all the registers. Buried state machines, counters, and registers can all coexist in one device, while running on separate clocks. The ATV750/L clock period matches that of similar synchronous devices.
- **A Full Bank of 10 More Registers** - The ATV750/L provides two flip-flops for each output macrocell - a total of 20. Each register has its own clock and reset product terms, as well as its own SUM term.
- **Independent I/O Pin and Feedback Paths** - Each I/O pin on the ATV750/L has a dedicated input path. Each of the 20 registers has individual feedback terms into the array. This feature, combined with individual product terms for each I/O's output enable, facilitates designs using bi-directional I/O buses.
- **Combinable Sum Terms** - Each output macrocell's two SUM terms can be combined in an OR gate before the output or the register. This provides up to 16 product terms per output or flip-flop. This architecture increases the number of usable gates available.

## Programming Software Support

Software which is capable of transforming Boolean equations, state machine descriptions and truth tables into JEDEC files for the ATV750/L is available from the following sources:

Data I/O Corp. - Abel 2.1, 3.0, and above  
 Logical Devices - Cupl 2.15B, and above

## Synchronous Preset and Asynchronous Reset

One synchronous preset line is provided for all 20 registers in the ATV750/L. The appropriate input signals to cause the internal clocks to go to a high state must be received during a synchronous preset. Appropriate setup and hold times must be met, as shown in the switching waveform diagram.

An individual asynchronous reset line is provided for each of the 20 flip-flops. Both master and slave halves of the flip-flops are reset when the input signals received combine so as to force the internal resets high.

## Security Fuse Usage

A single fuse is provided to prevent unauthorized copying of the ATV750/L fuse patterns. Once programmed, the output buffers will remain in a high impedance state during verify.

The security fuse should be programmed last, as its effect is immediate.

## Erasure Characteristics

The entire memory array of an ATV750/L is erased after exposure to ultraviolet light at a wavelength of 2537 Å. Complete erasure is assured after a minimum of 20 minutes exposure using 12,000  $\mu\text{W}/\text{cm}^2$  intensity lamps spaced one inch away from the chip. Minimum erase time for lamps at other intensity ratings can be calculated from the minimum integrated erasure dose of 15  $\text{W} \cdot \text{sec}/\text{cm}^2$ . To prevent unintentional erasure, an opaque label is recommended to cover the clear window on any UV erasable PLD which will be subjected to continuous fluorescent indoor lighting or sunlight.

## Atmel CMOS PLDs

Atmel's Programmable Logic Devices utilize an advanced 1.5-micron CMOS EPROM technology. This technology's state of the art features are the optimum combination for PLDs:

- CMOS technology provides high speed, low power, and high noise immunity.
- EPROM technology is the most cost effective method for producing PLDs - surpassing bipolar fusible link technology in low cost, while providing the necessary reprogrammability.
- EPROM reprogrammability, which is 100% tested before shipment, provides inherently better programmability and reliability than one-time fusible PLDs.
- Atmel's EPROM process has proven extremely reliable in the volume production of a full line of advanced EPROM memory products, from 64K to one-megabit devices.





V750 ICC vs FREQUENCY

TA = 25C, VCC = 5V

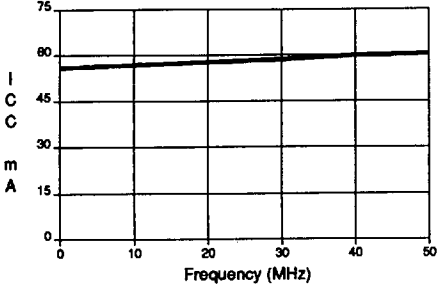

V750L ICC vs FREQUENCY

TA = 25C, VCC = 5V

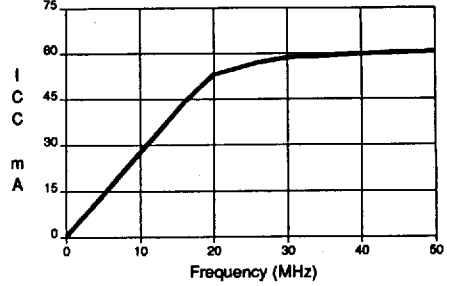

NORMALIZED ICC vs. VCC

TA = 25C, f = 30 MHz

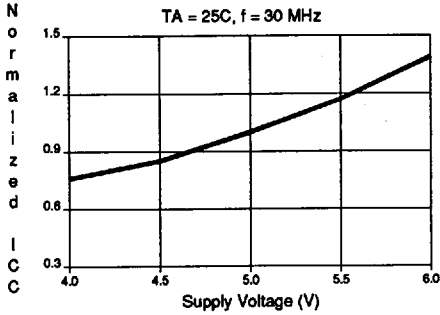

NORMALIZED ICC vs. AMBIENT TEMP.

f = 30 MHz, VCC = 5V

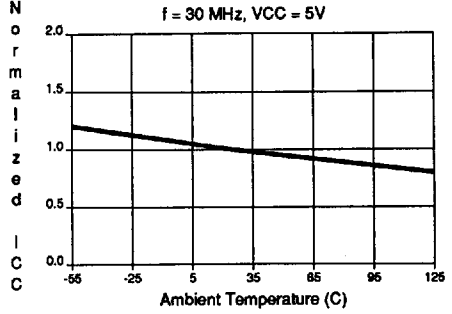

## Ordering Information

tpD (ns)	tCO (ns)	fMAX (MHz)	Ordering Code	Package	Operation Range
20	20	55	ATV750-20DC	24DW3	Commercial (0°C to 70°C)
			ATV750-20GC	24D3	
			ATV750-20JC	28J	
			ATV750-20KC	28KW	
			ATV750-20LC	28LW	
			ATV750-20NC	28L	
			ATV750-20PC	24P3	
			ATV750-20SC	24S	
		ATV750-20DI	24DW3	Industrial (-40°C to 85°C)	
		ATV750-20GI	24D3		
		ATV750-20JI	28J		
		ATV750-20KI	28KW		
		ATV750-20LI	28LW		
		ATV750-20NI	28L		
		ATV750-20PI	24P3		
		ATV750-20SI	24S		
ATV750-20DM	24DW3	Military (-55°C to 125°C)			
ATV750-20GM	24D3				
ATV750-20KM	28KW				
ATV750-20LM	28LW				
ATV750-20NM	28L				
ATV750-20DM/883	24DW3	Military/883C (-55°C to 125°C) Class B, Fully Compliant			
ATV750-20GM/883	24D3				
ATV750-20KM/883	28KW				
ATV750-20LM/883	28LW				
ATV750-20NM/883	28L				
25	22	45	ATV750-25DC	24DW3	Commercial (0°C to 70°C)
			ATV750-25GC	24D3	
			ATV750-25JC	28J	
			ATV750-25KC	28KW	
			ATV750-25LC	28LW	
			ATV750-25NC	28L	
			ATV750-25PC	24P3	
			ATV750-25SC	24S	
		ATV750-25DI	24DW3	Industrial (-40°C to 85°C)	
		ATV750-25GI	24D3		
		ATV750-25JI	28J		
		ATV750-25KI	28KW		
		ATV750-25LI	28LW		
		ATV750-25NI	28L		
		ATV750-25PI	24P3		
		ATV750-25SI	24S		

1





## Ordering Information

tpd (ns)	tco (ns)	fMAX (MHz)	Ordering Code	Package	Operation Range
25	22	45	ATV750-25DM ATV750-25GM ATV750-25KM ATV750-25LM ATV750-25NM	24DW3 24D3 28KW 28LW 28L	Military (-55°C to 125°C)
			ATV750-25DM/883 ATV750-25GM/883 ATV750-25KM/883 ATV750-25LM/883 ATV750-25NM/883	24DW3 24D3 28KW 28LW 28L	Military/883C (-55°C to 125°C) Class B, Fully Compliant
30	25	40	ATV750-30DC ATV750-30GC ATV750-30JC ATV750-30KC ATV750-30LC ATV750-30NC ATV750-30PC ATV750-30SC	24DW3 24D3 28J 28KW 28LW 28L 24P3 24S	Commercial (0°C to 70°C)
			ATV750-30DI ATV750-30GI ATV750-30JI ATV750-30KI ATV750-30LI ATV750-30NI ATV750-30PI ATV750-30SI	24DW3 24D3 28J 28KW 28LW 28L 24P3 24S	Industrial (-40°C to 85°C)
			ATV750-30DM ATV750-30GM ATV750-30KM ATV750-30LM ATV750-30NM	24DW3 24D3 28KW 28LW 28L	Military (-55°C to 125°C)
			ATV750-30DM/883 ATV750-30GM/883 ATV750-30KM/883 ATV750-30LM/883 ATV750-30NM/883	24DW3 24D3 28KW 28LW 28L	Military/883C (-55°C to 125°C) Class B, Fully Compliant
			ATV750-35DC ATV750-35GC ATV750-35JC ATV750-35KC ATV750-35LC ATV750-35NC ATV750-35PC ATV750-35SC	24DW3 24D3 28J 28KW 28LW 28L 24P3 24S	Commercial (0°C to 70°C)

## Ordering Information

tpd (ns)	tCO (ns)	fMAX (MHz)	Ordering Code	Package	Operation Range
35	30	33	ATV750-35DI	24DW3	Industrial (-40°C to 85°C)
			ATV750-35GI	24D3	
			ATV750-35JI	28J	
			ATV750-35KI	28KW	
			ATV750-35LI	28LW	
			ATV750-35NI	28L	
			ATV750-35PI	24P3	
			ATV750-35SI	24S	
			ATV750-35DM	24DW3	
ATV750-35GM	24D3				
ATV750-35KM	28KW				
ATV750-35LM	28LW				
ATV750-35NM	28L				
ATV750-35DM/883	24DW3	Military/883C (-55°C to 125°C) Class B, Fully Compliant			
ATV750-35GM/883	24D3				
ATV750-35KM/883	28KW				
ATV750-35LM/883	28LW				
ATV750-35NM/883	28L				
20	20	55	5962-8872604LX	24DW3	Military/883C (-55°C to 125°C) Class B, Fully Compliant
			5962-88726043X	28LW	
25	22	45	5962-8872603LX	24DW3	Military/883C (-55°C to 125°C) Class B, Fully Compliant
			5962-88726033X	28LW	
35	30	33	5962-8872602LX	24DW3	Military/883C (-55°C to 125°C) Class B, Fully Compliant
			5962-88726023X	28LW	





## Ordering Information

tpd (ns)	tco (ns)	fMAX (MHz)	Ordering Code	Package	Operation Range
25	22	45	ATV750L-25DC ATV750L-25GC ATV750L-25JC ATV750L-25KC ATV750L-25LC ATV750L-25NC ATV750L-25PC ATV750L-25SC	24DW3 24D3 28J 28KW 28LW 28L 24P3 24S	Commercial (0°C to 70°C)
			ATV750L-25DI ATV750L-25GI ATV750L-25JI ATV750L-25KI ATV750L-25LI ATV750L-25NI ATV750L-25PI ATV750L-25SI	24DW3 24D3 28J 28KW 28LW 28L 24P3 24S	Industrial (-40°C to 85°C)
			ATV750L-25DM ATV750L-25GM ATV750L-25KM ATV750L-25LM ATV750L-25NM	24DW3 24D3 28KW 28LW 28L	Military (-55°C to 125°C)
			ATV750L-25DM/883 ATV750L-25GM/883 ATV750L-25KM/883 ATV750L-25LM/883 ATV750L-25NM/883	24DW3 24D3 28KW 28LW 28L	Military/883C (-55°C to 125°C) Class B, Fully Compliant
30	25	40	ATV750L-30DC ATV750L-30GC ATV750L-30JC ATV750L-30KC ATV750L-30LC ATV750L-30NC ATV750L-30PC ATV750L-30SC	24DW3 24D3 28J 28KW 28LW 28L 24P3 24S	Commercial (0°C to 70°C)
			ATV750L-30DI ATV750L-30GI ATV750L-30JI ATV750L-30KI ATV750L-30LI ATV750L-30NI ATV750L-30PI ATV750L-30SI	24DW3 24D3 28J 28KW 28LW 28L 24P3 24S	Industrial (-40°C to 85°C)

## Ordering Information

t <sub>PD</sub> (ns)	t <sub>CO</sub> (ns)	f <sub>MAX</sub> (MHz)	Ordering Code	Package	Operation Range
30	25	40	ATV750L-30DM ATV750L-30GM ATV750L-30KM ATV750L-30LM ATV750L-30NM	24DW3 24D3 28KW 28LW 28L	Military (-55°C to 125°C)
			ATV750L-30DM/883 ATV750L-30GM/883 ATV750L-30KM/883 ATV750L-30LM/883 ATV750L-30NM/883	24DW3 24D3 28KW 28LW 28L	Military/883C (-55°C to 125°C) Class B, Fully Compliant
25	22	45	5962-8872606LX 5962-88726063X	24DW3 28LW	Military/883C (-55°C to 125°C) Class B, Fully Compliant
30	25	40	5962-8872606LX 5962-88726063X	24DW3 28LW	Military/883C (-55°C to 125°C) Class B, Fully Compliant

### Package Type

<b>24DW3</b>	24 Lead, 0.300" Wide, Windowed, Ceramic Dual Inline Package (CerDip)
<b>24D3</b>	24 Lead, 0.300" Wide, Non-Windowed (OTP) Ceramic Dual Inline Package (CerDip)
<b>28J</b>	28 Lead, Plastic J-Leaded Chip Carrier OTP (PLCC)
<b>28KW</b>	28 Lead, Windowed, Ceramic J-Leaded Chip Carrier (JLCC)
<b>28LW</b>	28 Pad, Windowed, Ceramic Leadless Chip Carrier (LCC)
<b>28L</b>	28 Pad, Non-Windowed, Ceramic Leadless Chip Carrier OTP (LCC)
<b>24P3</b>	24 Lead, 0.300" Wide, Plastic Dual Inline Package OTP (PDIP)
<b>24S</b>	24 Lead, 0.300" Wide, Plastic Gull Wing Small Outline OTP (SOIC)

