

Vishay Draloric

## Ceramic AC Capacitors Class X1, 440V<sub>AC</sub> / Class Y2, 250V<sub>AC</sub>

**DESIGN:**

Disc capacitors with epoxy coating

**RATED VOLTAGE U<sub>R</sub>:**

(X1): 440V<sub>AC</sub>, 50Hz (IEC 60384-14.2)  
 (Y2): 250V<sub>AC</sub>, 50Hz (IEC 60384-14.2)  
 250V<sub>AC</sub>, 60Hz (UL1414, CSA C22.2)

**DIELECTRIC STRENGTH BETWEEN LEADS:**

Component test:  
 2200V<sub>AC</sub>, 50Hz, 2s  
 As repeated test admissible only once with  
 2000V<sub>AC</sub>, 50Hz, 2s  
 Random sampling test (destructive test):  
 1500V<sub>AC</sub>, 50Hz, 60s

**DIELECTRIC STRENGTH OF BODY INSULATION:**

2000V<sub>AC</sub>, 50Hz, 60s (destructive test)

**DISSIPATION FACTOR tan δ:**

≤ 25 · 10<sup>-3</sup>

**INSULATION RESISTANCE R<sub>is</sub>:**

≥ 6 · 10<sup>9</sup>Ω

**CATEGORY TEMPERATURE RANGE θ<sub>A</sub>:**

(- 40 to + 125)°C

**CLIMATIC CATEGORY ACC. TO EN60068-1:**

40/125/21

**COATING:**

Epoxy, dipped, insulating, flame retarding acc. to  
 UL 94V-0

**TAPING AND SPECIAL LEAD CONFIGURATIONS:**

On request

**MARKING:**

D ≤ 9mm

D ≥ 10mm

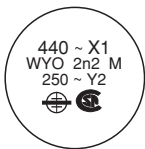

All approval marks are also shown on the label.

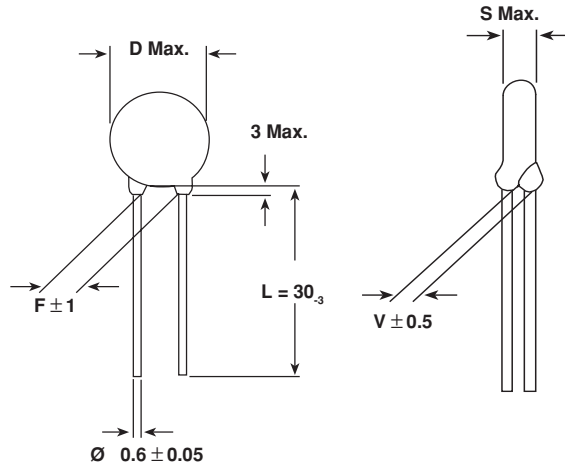

• Dimensions in mm

Impedance (Z) as a function of frequency (f) at T<sub>a</sub> = 20°C (average). Measurement with lead length 6mm.

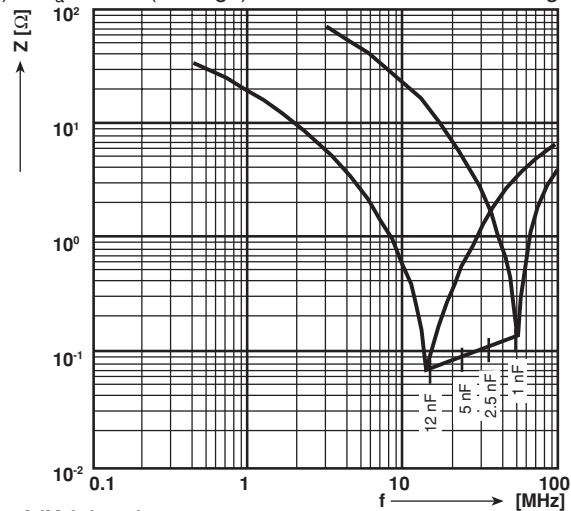

I = f (U<sub>R</sub>) (typ.)

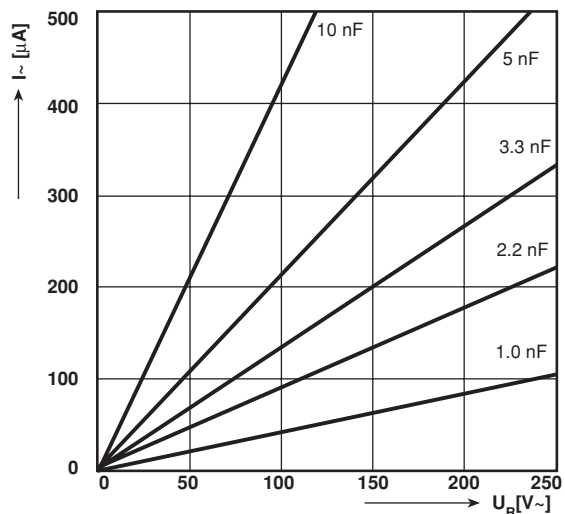

Ceramic AC Capacitors Class X1, 440V<sub>AC</sub> / Class Y2, 250V<sub>AC</sub> Vishay Draloric





CAPACITANCE (pF)	D x s Max. (mm)	F ± 1* (mm)	d ± 0.05* (mm)	V ± 0.5* (mm)	ORDERING CODE	CERAMIC DIELECTRIC
1000	6.5 x 4.5	5	0.6	1.4	WYO102□CM□□□K	K 4000
1500	8.0 x 4.5				WYO152□CM□□□K	
1800	8.0 x 4.5				WYO182□CM□□□K	
2200	9.0 x 4.5				WYO222□CM□□□K	
2500	9.0 x 4.5				WYO252□CM□□□K	
3300	10.0 x 4.5	7.5		1.6	WYO332□CM□□□K	
4700	12.0 x 4.5				WYO472□CM□□□K	
5000	12.0 x 4.5				WYO502□CM□□□K	
6800	17.0 x 4.5				WYO682□CM□□□K	
8200	17.0 x 4.5				WYO822□CM□□□K	
0.010μF	21.0 x 4.5		WYO103□CM□□□K			
0.012μF	21.0 x 4.5		WYO123□CM□□□K			

\*Standard lead configuration, other lead spacing and diameter available on request.

Capacitance Tolerances: ± 20%

<b>Ordering Code:</b>	<input type="checkbox"/> 7th digit:	Capacitance tolerance:	± 20% = M
	<input type="checkbox"/> 10th/11th/12th digit:	Lead configuration (See General Information)	

### APPROVALS

<b>IEC 60384-14 2<sup>ND</sup> edition (1993)</b> <b>Table II &amp; A 1 (1995-06)</b>	(Y2) CB-Test Certificate (X1) CB-Test Certificate	Fi 585 A 1 (250V <sub>AC</sub> ) Fi 508 A 2 (440V <sub>AC</sub> )	
<b>EN 132400 (1994)</b> These approvals together with the CB-Test Certificate substitutes the national approval of the nations given in the table below	(Y2) CB-Test Certificate (X1) CB-Test Certificate	DE 1-8789 (250V <sub>AC</sub> ) DE 1-8789 (440V <sub>AC</sub> )	
UL 1414	Line-by-pass & Antenna coupling capacitor	E 183844 V1 S2 (250V <sub>AC</sub> )	
CSA C22.2 No. 1-M1981	Across-the-line, line-to-ground and antenna isolation capacitor	LR 64546-10 (250V <sub>AC</sub> )	

This approval mark together with the CB-Certificate replace all national approval marks of the following countries (they have already signed the CB-Agreement):

Austria	Belgium	Denmark	Finland	Sweden
France	Germany	Ireland	Italy	Switzerland
Netherlands	Israel	Portugal	Spain	Great Britain
Japan	Norway	China	Poland	Czech. Republic
Singapore	Rep. of Korea	Hungary	Iceland	Slovenia

### ORDERING INFORMATION

<b>WYO</b> SERIES	<b>103</b> CAP. VALUE	<b>M</b> TOLERANCE	<b>CM</b> RATED VOLTAGE	<b>CF0</b> LEAD CONFIGURATION	<b>K</b> INTERNAL CODE
----------------------	--------------------------	-----------------------	----------------------------	-------------------------------------	---------------------------