

## Ultrabright LED, $\varnothing$ 5 mm Untinted Non-Diffused

### Description

The TLC.58.. series is a clear, non diffused 5 mm LED for high end applications where supreme luminous intensity and a very small emission angle is required. These lamps with clear untinted plastic case utilize the highly developed ultrabright AllnGaP and GaP technologies.

The very small viewing angle of these devices provide a very high luminous intensity.

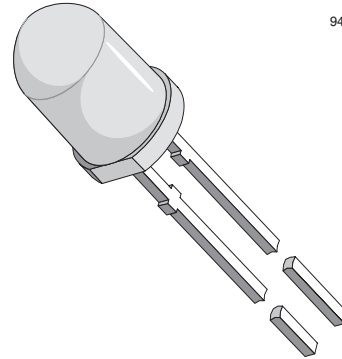

94 8631

### Features

- Untinted non diffused lens
- Utilizing ultrabright AllnGaP and InGaN technology
- Very high luminous intensity
- Very small emission angle
- High operating temperature:  $T_j$  (chip junction temperature) up to 125 °C for AllnGaP devices
- Luminous intensity and color categorized for each packing unit
- ESD-withstand voltage: 2 kV acc. to MIL STD 883 D, Method 3015.7 for AllnGaP, 1 kV for InGaN

### Applications

Interior and exterior lighting  
 Outdoor LED panels, displays  
 Instrumentation and front panel indicators  
 Central high mounted stop lights (CHMSL) for motor vehicles  
 Replaces incandescent lamps  
 Traffic signals and signs  
 Light guide design

### Parts Table

Part	Color, Luminous Intensity	Technology
TLCR5800	Red, $I_V > 7500$ mcd	AllGaP on GaAs
TLCY5800	Yellow, $I_V > 5750$ mcd	AllGaP on GaAs
TLCTG5800	True green, $I_V > 2400$ mcd	InGaN on SiC
TLCB5800	Blue, $I_V > 750$ mcd	InGaN on SiC

### Absolute Maximum Ratings

$T_{amb} = 25$  °C, unless otherwise specified

**TLCR5800 , TLCY5800 , TLCTG5800 , TLCB5800**

Parameter	Test condition	Part	Symbol	Value	Unit
Reverse voltage			$V_R$	5	V
DC forward current	$T_{amb} \leq 85$ °C	TLCR5800	$I_F$	50	mA
	$T_{amb} \leq 85$ °C	TLCR5800	$I_F$	50	mA
	$T_{amb} \leq 60$ °C	TLCTG5800	$I_F$	30	mA
	$T_{amb} \leq 60$ °C	TLCTG5800	$I_F$	30	mA

Parameter	Test condition	Part	Symbol	Value	Unit
Surge forward current	$t_p \leq 10 \mu s$	TLCR5800	$I_{FSM}$	1	A
	$t_p \leq 10 \mu s$	TLCR5800	$I_{FSM}$	1	A
	$t_p \leq 10 \mu s$	TLCTG5800	$I_{FSM}$	0.1	A
	$t_p \leq 10 \mu s$	TLCTG5800	$I_{FSM}$	0.1	A
Power dissipation	$T_{amb} \leq 85^\circ C$	TLCR5800	$P_V$	135	mW
	$T_{amb} \leq 85^\circ C$	TLCR5800	$P_V$	135	mW
	$T_{amb} \leq 60^\circ C$	TLCTG5800	$P_V$	135	mW
	$T_{amb} \leq 60^\circ C$	TLCTG5800	$P_V$	135	mW
Junction temperature		TLCR5800	$T_j$	125	$^\circ C$
		TLCR5800	$T_j$	125	$^\circ C$
		TLCTG5800	$T_j$	100	$^\circ C$
		TLCTG5800	$T_j$	100	$^\circ C$
Operating temperature range			$T_{amb}$	- 40 to + 100	$^\circ C$
Storage temperature range			$T_{stg}$	- 40 to + 100	$^\circ C$
Soldering temperature	$t \leq 5 s, 2 mm$ from body		$T_{sd}$	260	$^\circ C$
Thermal resistance junction/ambient			$R_{thJA}$	300	K/W

## Optical and Electrical Characteristics

$T_{amb} = 25^\circ C$ , unless otherwise specified

### Red

#### TLCR5800

Parameter	Test condition	Part	Symbol	Min	Typ.	Max	Unit
Luminous intensity <sup>1)</sup>	$I_F = 50 mA$	TLCR5800	$I_V$	7500	20000		
Dominant wavelength	$I_F = 50 mA$		$\lambda_d$	611	616	622	nm
Peak wavelength	$I_F = 50 mA$		$\lambda_p$		622		nm
Spectral bandwidth at 50 % $I_{rel max}$	$I_F = 50 mA$		$\Delta\lambda$		18		nm
Angle of half intensity	$I_F = 50 mA$		$\phi$		$\pm 4$		deg
Forward voltage	$I_F = 50 mA$		$V_F$		2.1	2.7	V
Reverse voltage	$I_R = 10 \mu A$		$V_R$	5			V
Temperature coefficient of $V_F$	$I_F = 50 mA$		$TC_{VF}$		- 3.5		mV/K
Temperature coefficient of $\lambda_d$	$I_F = 50 mA$		$TC_{\lambda d}$		0.05		nm/K

<sup>1)</sup> in one Packing Unit  $I_{VMax}/I_{VMin} \leq 1.6$

**Yellow**
**TLCY5800**

Parameter	Test condition	Part	Symbol	Min	Typ.	Max	Unit
Luminous intensity <sup>1)</sup>	$I_F = 50 \text{ mA}$	TLCY5800	$I_V$	5750	14000		mcd
Dominant wavelength	$I_F = 50 \text{ mA}$		$\lambda_d$	585	590	597	nm
Peak wavelength	$I_F = 50 \text{ mA}$		$\lambda_p$		593		nm
Spectral bandwidth at 50 % $I_{rel \text{ max}}$	$I_F = 50 \text{ mA}$		$\Delta\lambda$		17		nm
Angle of half intensity	$I_F = 50 \text{ mA}$		$\varphi$		$\pm 4$		deg
Forward voltage	$I_F = 50 \text{ mA}$		$V_F$		2.1	2.7	V
Reverse voltage	$I_R = 10 \mu\text{A}$		$V_R$	5			V
Temperature coefficient of $V_F$	$I_F = 50 \text{ mA}$		$TC_{V_F}$		- 3.5		mV/K
Temperature coefficient of $\lambda_d$	$I_F = 50 \text{ mA}$		$TC_{\lambda_d}$		0.1		nm/K

<sup>1)</sup> in one Packing Unit  $I_{V_{Max}}/I_{V_{Min}} \leq 1.6$

**Pure green**

Parameter	Test condition	Part	Symbol	Min	Typ.	Max	Unit
Luminous intensity <sup>1)</sup>	$I_F = 30 \text{ mA}$	TLCTG5800	$I_V$	2400	7000		mcd
Dominant wavelength	$I_F = 30 \text{ mA}$		$\lambda_d$	515	525	535	nm
Peak wavelength	$I_F = 30 \text{ mA}$		$\lambda_p$		520		nm
Spectral bandwidth at 50 % $I_{rel \text{ max}}$	$I_F = 30 \text{ mA}$		$\Delta\lambda$		37		nm
Angle of half intensity	$I_F = 30 \text{ mA}$		$\varphi$		$\pm 4$		deg
Forward voltage	$I_F = 30 \text{ mA}$		$V_F$		3.9	4.5	V
Reverse voltage	$I_R = 10 \mu\text{A}$		$V_R$	5			V
Temperature coefficient of $V_F$	$I_F = 30 \text{ mA}$		$TC_{V_F}$		- 4.5		mV/K
Temperature coefficient of $\lambda_d$	$I_F = 30 \text{ mA}$		$TC_{\lambda_d}$		0.02		nm/K

<sup>1)</sup> in one Packing Unit  $I_{V_{Max}}/I_{V_{Min}} \leq 1.6$

**Blue**
**TLCB5800**

Parameter	Test condition	Part	Symbol	Min	Typ.	Max	Unit
Luminous intensity <sup>1)</sup>	$I_F = 30 \text{ mA}$	TLCB5800	$I_V$	750	2500		mcd
Dominant wavelength	$I_F = 30 \text{ mA}$		$\lambda_d$	462	470	476	nm
Peak wavelength	$I_F = 30 \text{ mA}$		$\lambda_p$		464		nm
Spectral bandwidth at 50 % $I_{rel \text{ max}}$	$I_F = 30 \text{ mA}$		$\Delta\lambda$		25		nm
Angle of half intensity	$I_F = 30 \text{ mA}$		$\varphi$		$\pm 4$		deg
Forward voltage	$I_F = 30 \text{ mA}$		$V_F$		3.9	4.5	V
Reverse voltage	$I_R = 10 \mu\text{A}$		$V_R$	5			V
Temperature coefficient of $V_F$	$I_F = 30 \text{ mA}$		$TC_{V_F}$		- 5.0		mV/K
Temperature coefficient of $\lambda_d$	$I_F = 30 \text{ mA}$		$TC_{\lambda_d}$		0.02		nm/K

<sup>1)</sup> in one Packing Unit  $I_{V_{Max}}/I_{V_{Min}} \leq 1.6$

### Typical Characteristics ( $T_{amb} = 25\text{ }^{\circ}\text{C}$ unless otherwise specified)

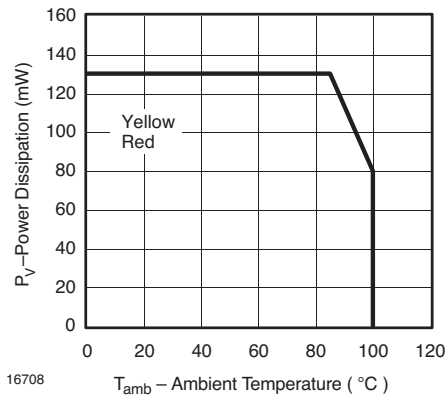

Figure 1. Power Dissipation vs. Ambient Temperature

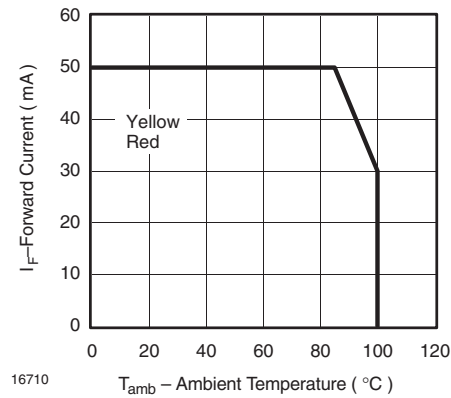

Figure 4. Forward Current vs. Ambient Temperature

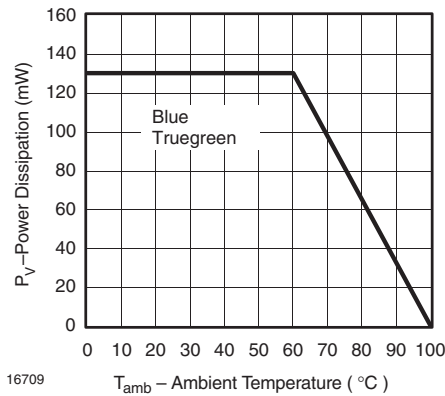

Figure 2. Power Dissipation vs. Ambient Temperature

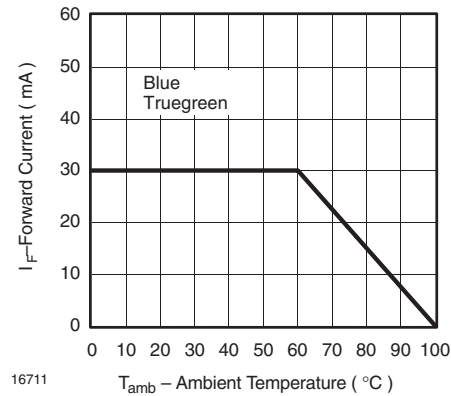

Figure 5. Forward Current vs. Ambient Temperature

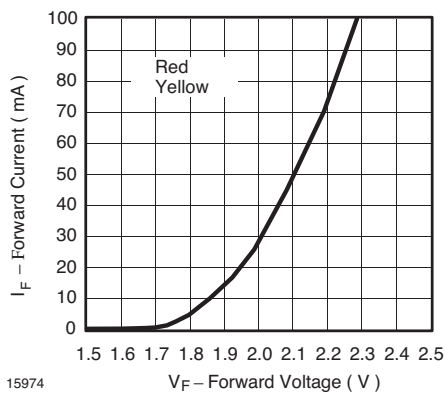

Figure 3. Forward Current vs. Forward Voltage

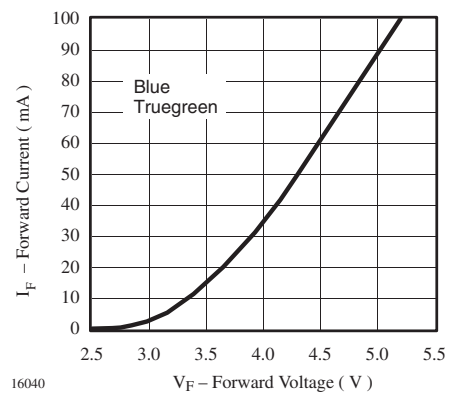

Figure 6. Forward Current vs. Forward Voltage

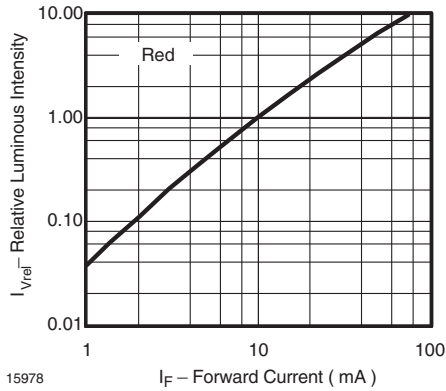

Figure 7. Relative Luminous Flux vs. Forward Current

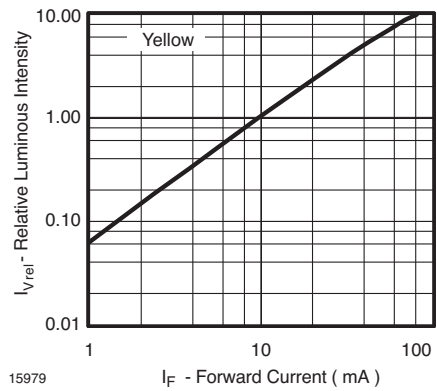

Figure 10. Relative Luminous Flux vs. Forward Current

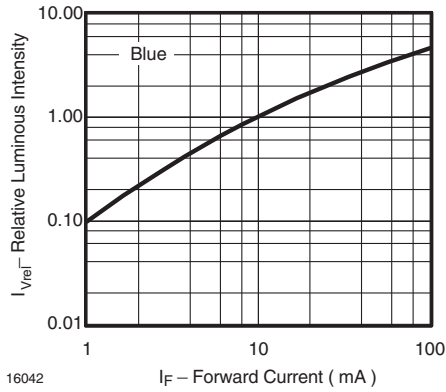

Figure 8. Relative Luminous Flux vs. Forward Current

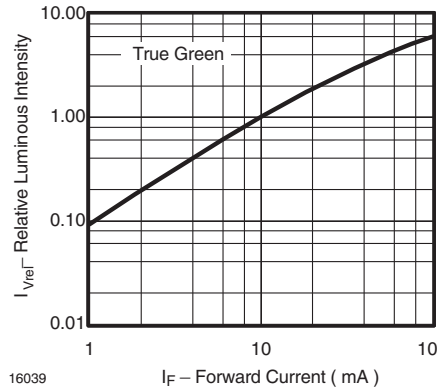

Figure 11. Relative Luminous Flux vs. Forward Current

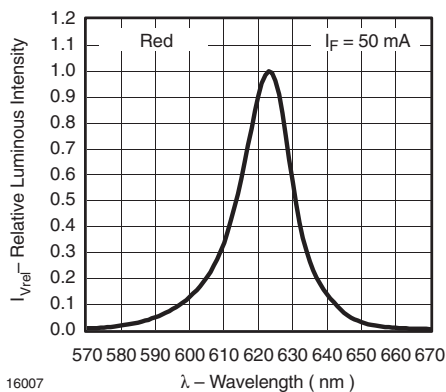

Figure 9. Relative Intensity vs. Wavelength

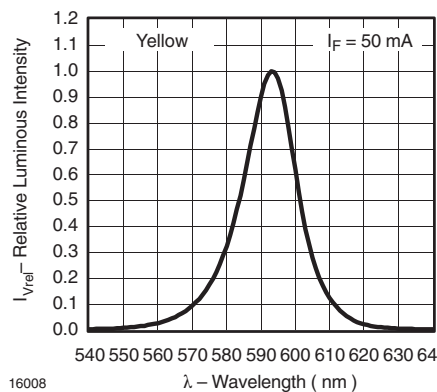

Figure 12. Relative Intensity vs. Wavelength

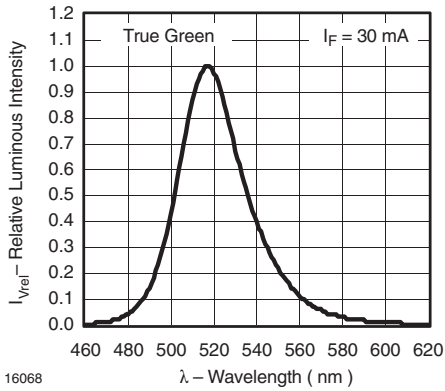

Figure 13. Relative Intensity vs. Wavelength

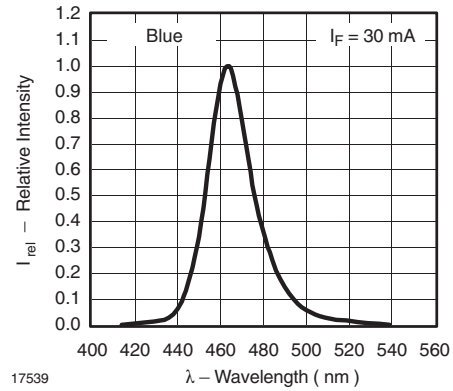
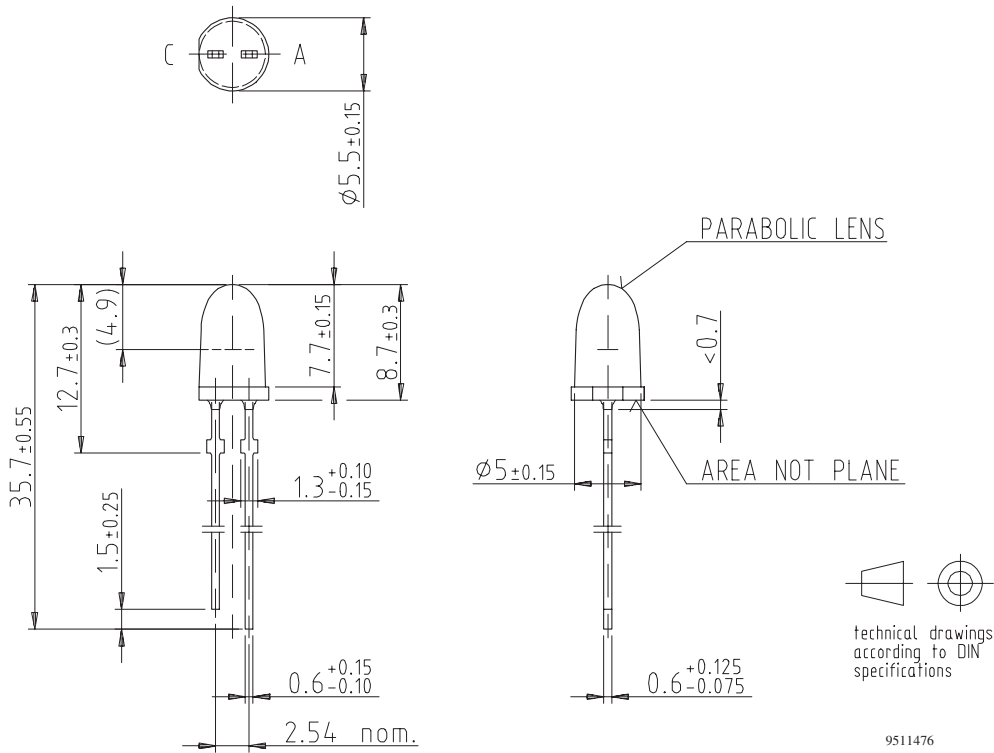

Figure 14. Relative Intensity vs. Wavelength

## Package Dimensions in mm



## **Ozone Depleting Substances Policy Statement**

It is the policy of **Vishay Semiconductor GmbH** to

1. Meet all present and future national and international statutory requirements.
2. Regularly and continuously improve the performance of our products, processes, distribution and operating systems with respect to their impact on the health and safety of our employees and the public, as well as their impact on the environment.

It is particular concern to control or eliminate releases of those substances into the atmosphere which are known as ozone depleting substances (ODSs).

The Montreal Protocol (1987) and its London Amendments (1990) intend to severely restrict the use of ODSs and forbid their use within the next ten years. Various national and international initiatives are pressing for an earlier ban on these substances.

**Vishay Semiconductor GmbH** has been able to use its policy of continuous improvements to eliminate the use of ODSs listed in the following documents.

1. Annex A, B and list of transitional substances of the Montreal Protocol and the London Amendments respectively
2. Class I and II ozone depleting substances in the Clean Air Act Amendments of 1990 by the Environmental Protection Agency (EPA) in the USA
3. Council Decision 88/540/EEC and 91/690/EEC Annex A, B and C (transitional substances) respectively.

**Vishay Semiconductor GmbH** can certify that our semiconductors are not manufactured with ozone depleting substances and do not contain such substances.

**We reserve the right to make changes to improve technical design  
and may do so without further notice.**

Parameters can vary in different applications. All operating parameters must be validated for each customer application by the customer. Should the buyer use Vishay Semiconductors products for any unintended or unauthorized application, the buyer shall indemnify Vishay Semiconductors against all claims, costs, damages, and expenses, arising out of, directly or indirectly, any claim of personal damage, injury or death associated with such unintended or unauthorized use.

Vishay Semiconductor GmbH, P.O.B. 3535, D-74025 Heilbronn, Germany  
Telephone: 49 (0)7131 67 2831, Fax number: 49 (0)7131 67 2423