

---

**MSC7128-xx**

---

**5 × 7-Dot Character × 16-Digit Display Controller/Driver**

---

**GENERAL DESCRIPTION**

The MSC7128-xx is a general purpose display controller for vacuum fluorescent display tube.

The MSC7128-xx drives displays with up to 35 anodes (dots) and up to 16 grids (characters) plus a cursor.

The controller accepts command and display data input words on a clocked serial input line. Commands control the on/off duty cycle, starting character position, number of characters to display and display modes (PLA mode and Lamp Test mode). An internal PLA-type character generator provides character decoding and dot pattern generation for the full 128 characters.

A 35 × 128-bit PLA (ROM) code is programmable.

**FEATURES**

- Logic supply voltage ( $V_{DD}$ ) : +5V
- VF driver supply voltage ( $V_{EE}$ ) : -55V
- Driver output current
  - VF grid driver : -30mA
  - VF anode driver : -2mA
  - VF cursor driver : -10mA
- Direct drive capability for vacuum fluorescent display (no pull-down resistor is required)
- Built-in oscillation circuit
- Built-in power-on-reset circuit with external C
- Serial host interface (data in, clock, chip select)
- Serial data input for 8-bit control and display data words
- Command functions
  - On/off duty cycle : 0/16 to 15/16
  - Character display position : 0 to 15
  - Number of display digits : 1 to 16
  - Display modes : PLA mode, and Lamp Test mode
- Built-in 35 × 128-bit PLA-type character generator
  - Character font : 5 × 7
  - Number of characters : 128
  - Programmable PLA code
- Package options:
  - 64-pin plastic SDIP (SDIP64-P-750-1.78) (Product name : MSM7128-xxSS)
  - 64-pin plastic QFP (QFP64-P-1420-1.00-BK) (Product name : MSM7128-xxGS-BK)

xx indicates the code number.

BLOCK DIAGRAM

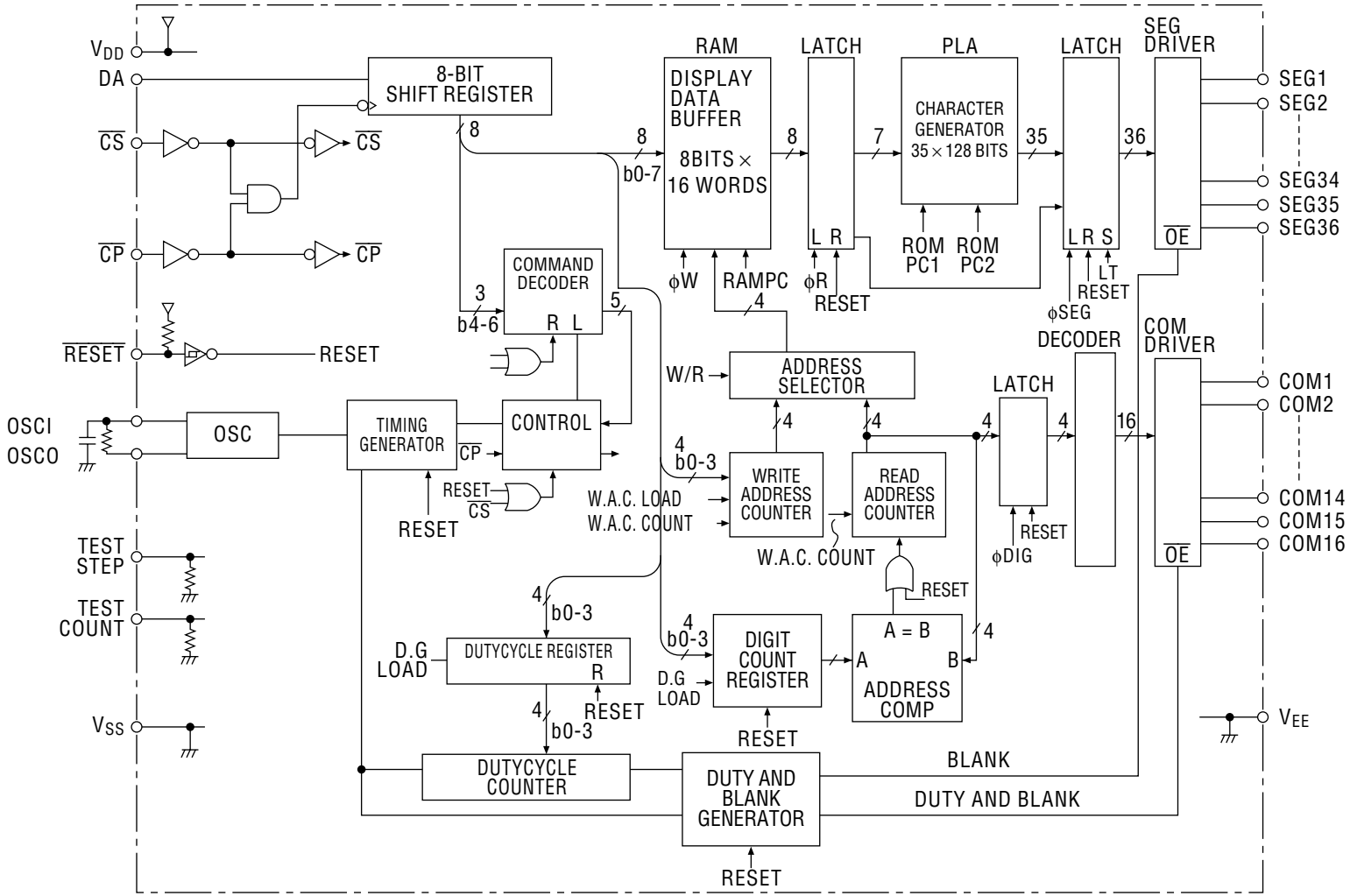

## INPUT AND OUTPUT CONFIGURATION

### • INPUT PIN

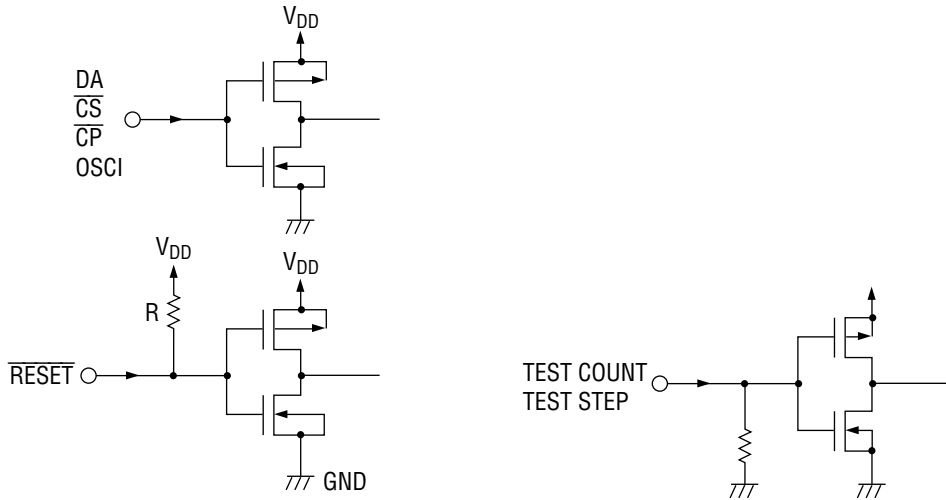

### • OUTPUT PIN

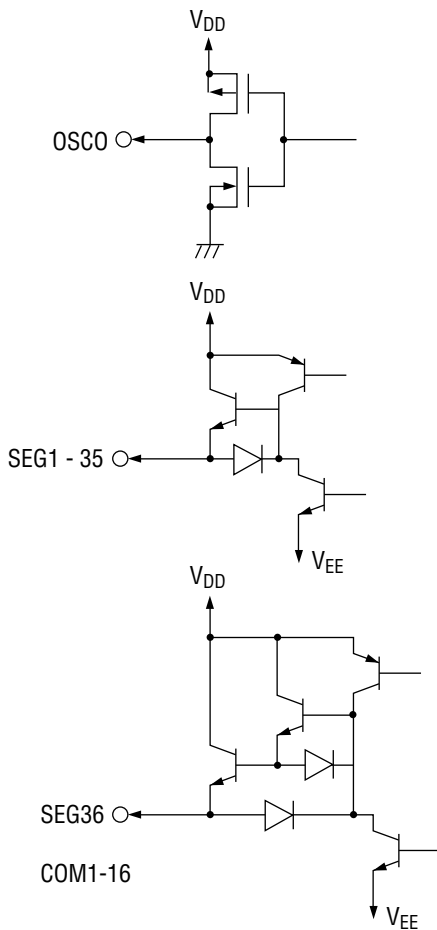

**PIN CONFIGURATION (TOP VIEW)**

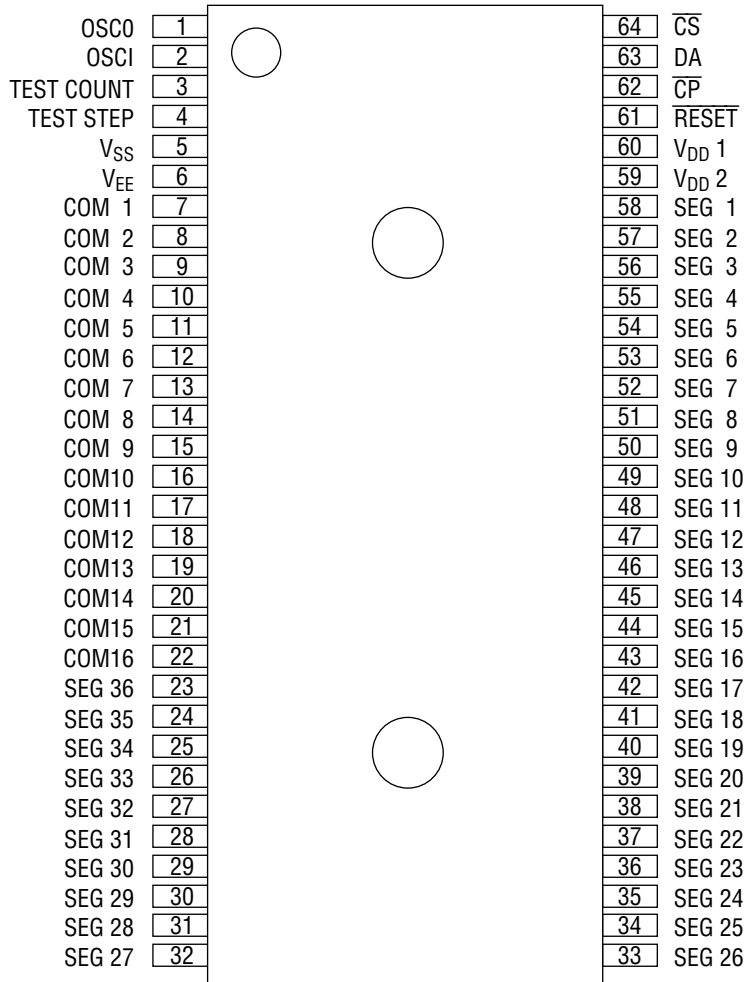

**64-Pin Plastic Shrink DIP**

**PIN CONFIGURATION (TOP VIEW)**

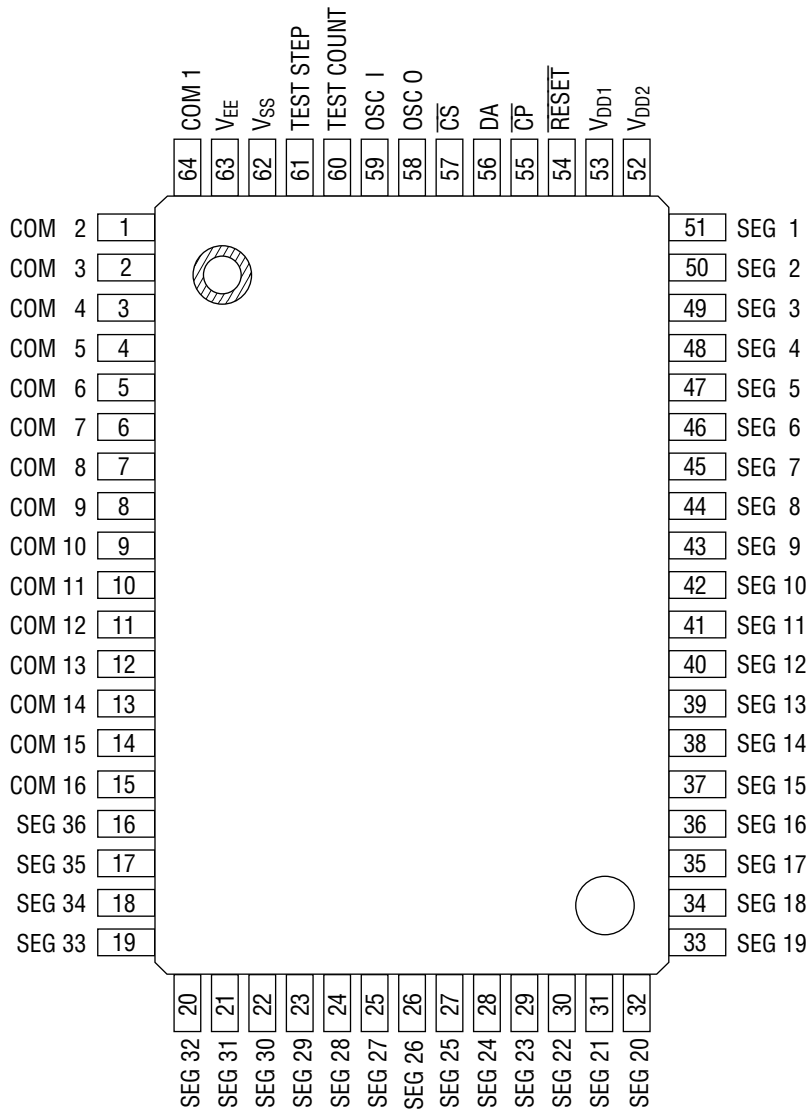

**64-Pin Plastic QFP**

## PIN DESCRIPTION

Symbol	Type	Connected to	Description
$V_{DD1}$	—	Power source	$V_{DD1} - V_{SS}$ : Internal logic supply voltage $V_{DD2} - V_{EE}$ : VF tube driving circuit supply voltage
$V_{DD2}$	—		
$V_{SS}$	—		
$V_{EE}$	—		
DA	I	Microcomputer	Serial data input from LSB (positive logic)
$\overline{CP}$	I	Microcomputer	Shift clock input. Data is shifted at the leading edge of the $\overline{CP}$ .
$\overline{CS}$	I	Microcomputer	Chip select input. When the PIN is High, the serial data transfer is inhibited.
OSCI	I	—	RC oscillation, external RC pin. $f_{OSC} \approx 250\text{kHz}$ at $C = 100\text{pF}$ and $R = 47\text{k}\Omega$ .
OSCO	O		
$\overline{RESET}$	I	—	Reset input (pull-up resistor built in). When the pin is Low, the internal logic is reset, and the outputs of SEG1 to SEG36 and COM1 to COM16 are Low.
COM1 ↕ COM16	O	VF tube grid electrode	VF tube grid electrode driving outputs. This pin can be connected directly to the VF tube. No pull-down resistor is required. $I_{OH} > -30\text{mA}$
SEG1 ↕ SEG35	O	VF tube anode electrode	VF tube 5 × 7 -dot anode electrode driving outputs. This pin can be connected directly to the VF tube. No pull-down resistor is required. $I_{OH} > -2\text{mA}$
SEG36	O	VF tube anode electrode	VF tube cursor anode electrode driving output. This pin can be connected directly to the VF tube. No pull-down resistor is required. $I_{OH} > -10\text{mA}$
TEST STEP	I	—	Test mode setting input (normally open)
TEST COUNT	I	—	Test clock input (normally open)

**ABSOLUTE MAXIMUM RATINGS**

Parameter	Symbol	Condition	Rating	Unit
Power Supply Voltage (1)	$V_{DD}-V_{SS}$	—	-0.3 to +6.5	V
Power Supply Voltage (2)	$V_{DD}-V_{EE}$	—	0 to 65	V
Input Voltage	$V_{IN}-V_{SS}$	—	-0.3 to $V_{DD} + 0.3$	V
Power Dissipation	$P_D$	$T_a \leq 25^\circ\text{C}$	Up to 1.0	W
Storage Temperature	$T_{STG}$	—	-55 to +150	$^\circ\text{C}$
Output Current	$I_{O1}$	COM1 to COM16	-40	mA
	$I_{O2}$	SEG1 to SEG35	-4	mA
	$I_{O3}$	SEG36	-15	mA

**RECOMMENDED OPERATING CONDITIONS**

Parameter	Symbol	Condition	Min.	Typ.	Max.	Unit
Power Supply Voltage (1)	$V_{DD}-V_{SS}$	—	4.5	—	5.5	V
Power Supply Voltage (2)	$V_{DD}-V_{EE}$	—	10	—	60	V
High Level Input Voltage	$V_{IH}-V_{SS}$	—	$0.7V_{DD}$	—	—	V
Low Level Input Voltage	$V_{IL}-V_{SS}$	—	—	—	$0.3V_{DD}$	V
$\overline{CP}$ Frequency	$f_{\overline{CP}}$	—	—	—	500	kHz
OSC Frequency	$f_{OSC}$	100pF, 47k $\Omega$	170	220	270	kHz
Operating Temperature	$T_{OP}$	—	-20	—	+75	$^\circ\text{C}$

**ELECTRICAL CHARACTERISTICS**

**DC Characteristics**

( $V_{DD}-V_{SS} = 5V \pm 10\%$ ,  $V_{DD}-V_{EE} = 60V$ ,  $T_a = -20$  to  $+75^\circ C$ )

Parameter	Symbol	Condition	Min.	Max.	Unit
High Level Input Voltage	$V_{IH}$	—	$0.7V_{DD}$	—	V
Low Level Input Voltage	$V_{IL}$	—	—	$0.3V_{DD}$	V
High Level Input Current	$I_{IH1}$	DA, $\overline{CP}$ , $\overline{CS}$ $\overline{RESET}$ $V_{DD} = 5.5V$ $V_{IN} = 5V$	-5	5	$\mu A$
	$I_{IH2}$	TEST STEP TEST COUNT $V_{DD} = 5.5V$ $V_{IN} = 5V$	0.25	1	mA
Low Level Input Current	$I_{IL1}$	DA, $\overline{CP}$ , $\overline{CS}$ TEST STEP TEST COUNT $V_{DD} = 5.5V$ $V_{IH} = 0.5V$	-5	5	$\mu A$
	$I_{IL2}$	$\overline{RESET}$ $V_{DD} = 5.5V$ $V_{IH} = 0.5V$	-25	-100	$\mu A$
High Level Output Voltage	$V_{OH1}$	OSCO $I_{OH} = -500\mu A$	$V_{DD}-0.6$	—	V
	$V_{OH2}$	COM1~16 $I_{OH} = -30mA$	$V_{DD}-4$	—	V
	$V_{OH3}$	SEG1~35 $I_{OH} = -2mA$	$V_{DD}-3$	—	V
	$V_{OH4}$	SEG36 $I_{OH} = -10mA$	$V_{DD}-4$	—	V
Low Level Output Voltage	$V_{OL1}$	OSCO $I_{OL} = 500\mu A$	—	$V_{SS}+0.6$	V
	$V_{OL2}$	COM1~16 $I_{OL} = 100\mu A$	—	$V_{EE}+3$	V
	$V_{OL3}$	SEG1~35 $I_{OL} = 100\mu A$	—	$V_{EE}+3$	V
	$V_{OL4}$	SEG36 $I_{OL} = 100\mu A$	—	$V_{EE}+3$	V
Current Consumption	$I_{SS1}$	All SEGs on, 16-digit display, duty cycle 15/16, no load	—	15	mA
	$I_{SS2}$	All SEGs Low, all COMs High	—	1.5	mA
	$I_{EE1}$	All SEGs on, 16-digit display, duty cycle 15/16, no load	—	1.0	mA
	$I_{EE2}$	All SEGs Low, all COMs High	—	15	mA



**AC Characteristics**

( $V_{DD}-V_{SS} = 5V \pm 10\%$ ,  $T_a = -20$  to  $+75^\circ C$ )

Parameter	Symbol	Condition	Min.	Max.	Unit
$\overline{CP}$ Cycle Time	$t_{CP}$	—	2	—	$\mu s$
$\overline{CP}$ Pulse Width	$t_{WCP}$	—	1	—	$\mu s$
Data Set-up Time	$t_{DS}$	—	0.5	—	$\mu s$
Data Hold Time	$t_{DH}$	—	0.5	—	$\mu s$
$\overline{CS}$ Set-up Time	$t_{CSS}$	—	1	—	$\mu s$
$\overline{CS}$ Hold Time	$t_{CSH}$	—	32T*	—	s
OSC Frequency	$f_{OSC}$	$R = 47k\Omega, C = 100pF$	170	270	kHz

\*T =  $1/f_{OSC}$

**TIMING DIAGRAM**

**Data Timing**

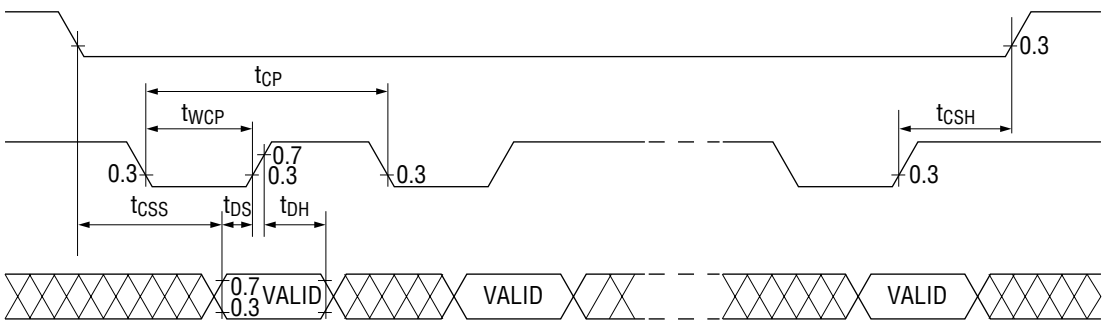

**Data LSB/MSB Timing**

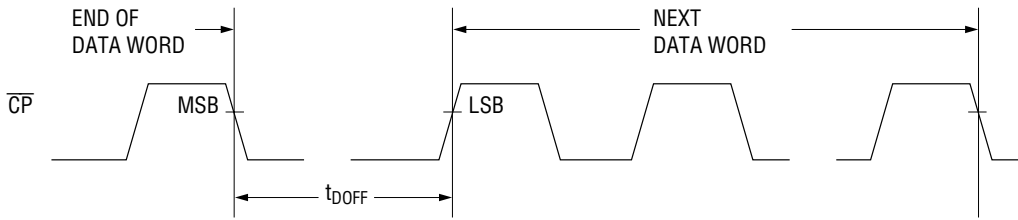

DATA INPUT OFF TIME  $t_{DOFF} = 32T_{min}$  ( $T=1/f_{osc}$ )

**Digit Timing (16-Digit Display)**

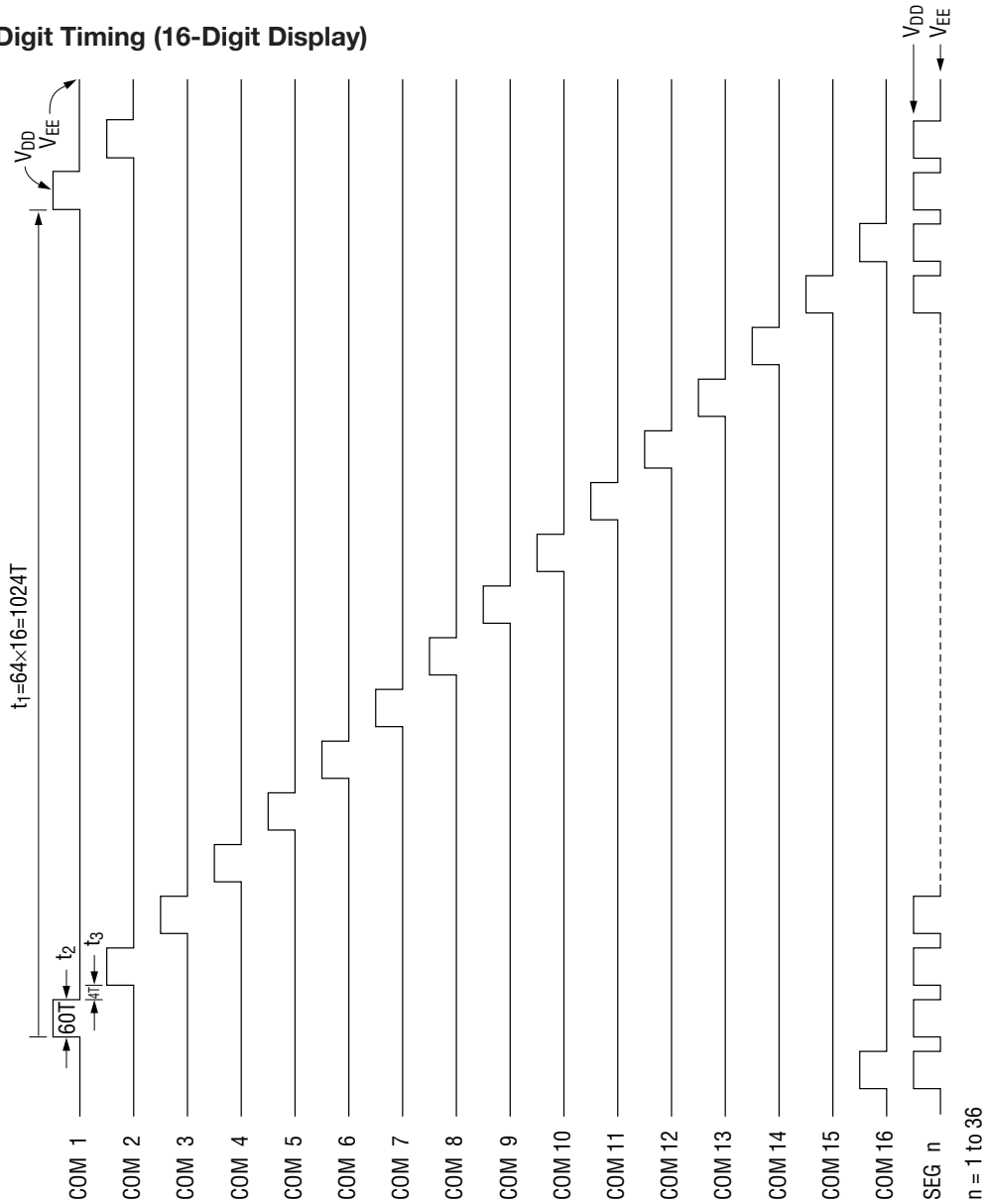

$t_1$  = Frame count  
 $t_2$  = Display timing  
 $t_3$  = Blank timing

$T = 1/f_{osc}$

When  $f_{osc} = 245\text{kHz}$   
 $t_1^* = 4.096\text{ms}$   
 $t_2 = 240\mu\text{s}$   
 $t_3 = 16\mu\text{s}$

**Reset Timing**

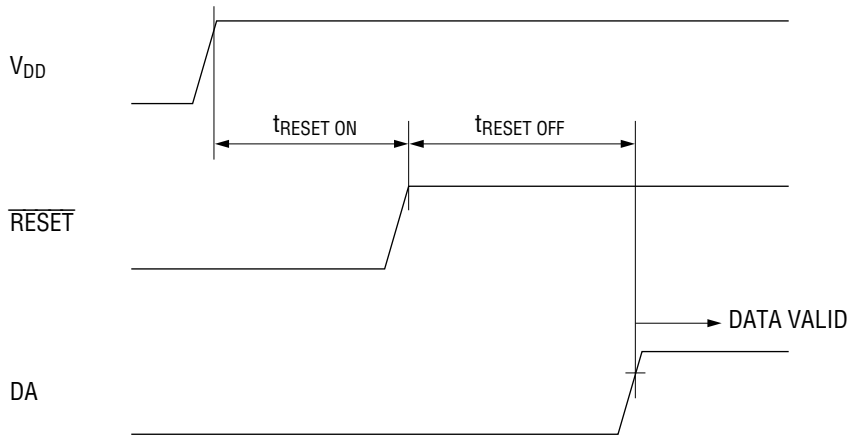

OPTION 1

When a capacitor is connected between the  $\overline{\text{RESET}}$  pin and  $V_{SS}$ ,  
 RESET ON TIME  $t_{\text{RESET ON}}$  : 250ms typ.  
 RESET OFF TIME  $t_{\text{RESET OFF}}$  : 50 $\mu$ s min.  
 (External capacitor : 1 $\mu$ F)

OPTION 2

When a  $\overline{\text{RESET}}$  signal is externally input,  
 RESET ON TIME  $t_{\text{RESET ON}}$  : 50 $\mu$ s min.  
 RESET OFF TIME  $t_{\text{RESET OFF}}$  : 50 $\mu$ s min.

## FUNCTIONAL DESCRIPTION

### Data Transfer Method and Command Write Method

A display control command or data is written by the 8-bit serial transfer method. The figure below shows the write timing. When the  $\overline{CS}$  pin is Low, data can be transferred. Data of 8 bits in length is input to the DA pin sequentially starting with the LSB. (LSB first)

Data is shifted at the rising edge of a shift clock pulse which is input to the  $\overline{CP}$  pin as shown in the figure below. When 8-bit data is entered, an inner LOAD signal is automatically generated, and data is written into the registers and RAM. Therefore, there is no need to input an external LOAD signal.

If the  $\overline{CS}$  pin is changed from Low to High, the serial transfer is inhibited, and data, which is entered after the  $\overline{CS}$  pin is changed from High to Low, is recognized in units of 8 bits.

The first 8 bits become the first byte, and the second 8 bits become the second byte and the next 8 bits become either the first byte or the second byte depending on the selected command.

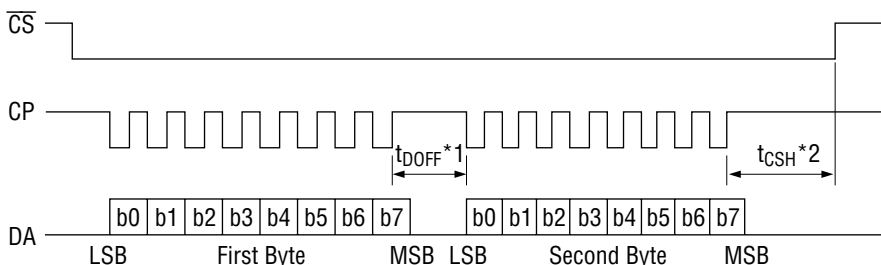

\*1  $t_{DOFF}$  : Refer to Data LSB/MSB Timing.

\*2  $t_{CSH}$  : Refer to AC Characteristics and Data Timing.

### Command Type

No.	Command	First Byte								Second Byte							
		b7	b6	b5	b4	b3	b2	b1	b0	b7	b6	b5	b4	b3	b2	b1	b0
0	Address Set	1	0	0	0	X	X	X	X	X	X	X	X	X <sub>3</sub>	X <sub>2</sub>	X <sub>1</sub>	X <sub>0</sub>
1	Character Code Set	1	0	0	1	X	X	X	X	CU	CH <sub>6</sub>	CH <sub>5</sub>	CH <sub>4</sub>	CH <sub>3</sub>	CH <sub>2</sub>	CH <sub>1</sub>	CH <sub>0</sub>
2	Display Duty Set	1	0	1	0	X	X	X	X	X	X	X	X	DC <sub>3</sub>	DC <sub>2</sub>	DC <sub>1</sub>	DC <sub>0</sub>
3	Number of Display Digits Set	1	0	1	1	X	X	X	X	X	X	X	X	DG <sub>3</sub>	DG <sub>2</sub>	DG <sub>1</sub>	DG <sub>0</sub>
4	Lamp Test	1	1	0	0	X	X	X	X	X	X	X	X	X	X	X	LT

\*1 When character codes are to be continuously transferred, addresses are automatically incremented (internally). Accordingly, neither the Address Set command nor the first byte of the Character Code Set command are required to set the second and the following character codes.

\*2 X : Don't care

**Command Description**

• **Address set command**

When the code of a display character is to be set, this command is used to specify the display location (digit number) of the character.

The relation between the digit number X and common outputs COM1 to COM16 is as follows:

X	COM Input
0	COM1
1	COM2
⋮	⋮
15	COM16

Command format

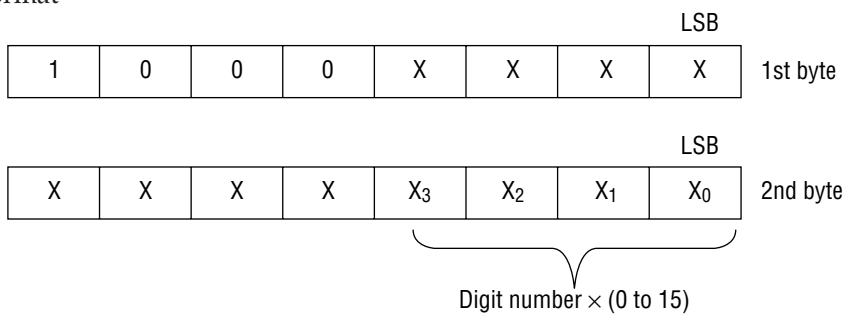

• **Character code set command**

This command is used to specify the character to be displayed in the digit place specified by the Address Set command. Bits 0 to 6 of the second byte are used to specify the character code, and bit 7 is used to specify "Yes" or "No" of cursor display.

Command format

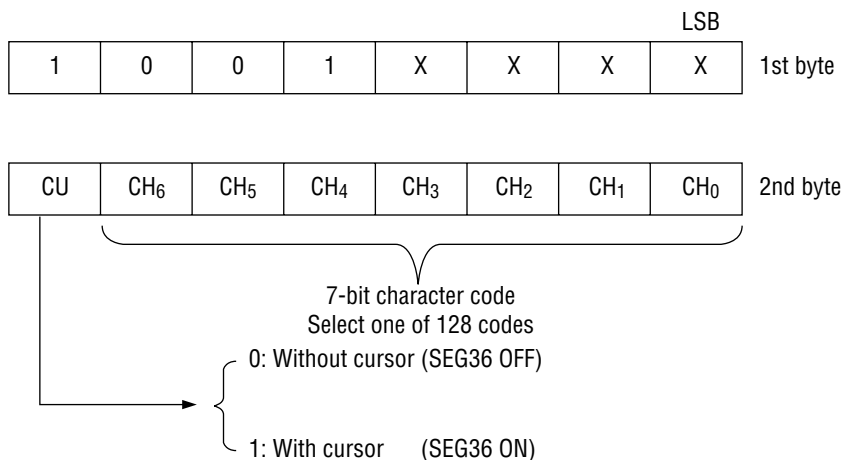

An automatic address increment function is built in. To write multidigit display character codes, issue the Address Set command. To transfer the second and later digit display character codes, the first byte (operation code) of the Character Code command is not required. Input the second byte.

When this command is executed, 8-bit data for the second byte and later bytes, which is provided before the  $\overline{CS}$  pin is turned High, is all treated as display character data.

Transfer examples of the Address Set command and the Character Set command

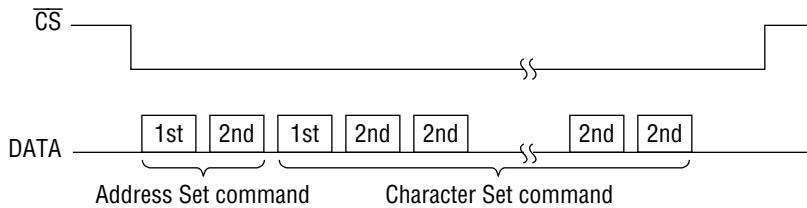

Example 1: The display for COM3 and the following is changed.

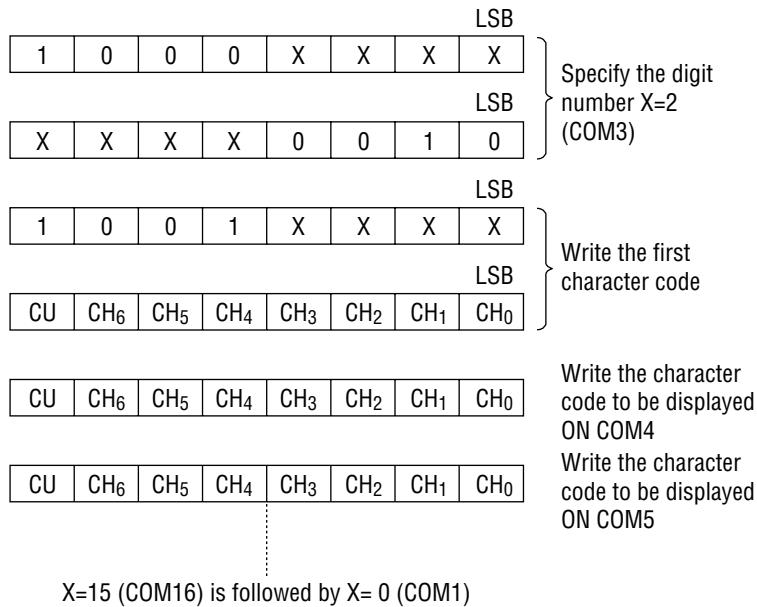

### Number of Display Digits Set Command

This command is used to set the digit count register and the number of display digits. The number of digits to be set ranges from 1 to 16.

Command format

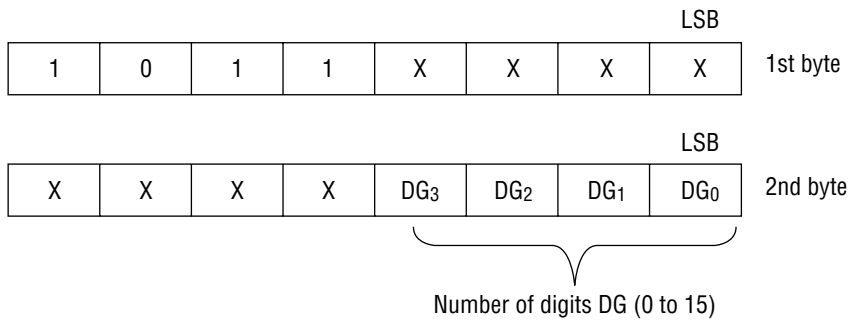

The relation between the value of DG to be set and COM under display control is as follows:

DG	COM Displayed	DG	COM Displayed
0	COM1 - COM16	8	COM1 - COM8
1	COM1	9	COM1 - COM9
2	COM1 - COM2	10	COM1 - COM10
3	COM1 - COM3	11	COM1 - COM11
4	COM1 - COM4	12	COM1 - COM12
5	COM1 - COM5	13	COM1 - COM13
6	COM1 - COM6	14	COM1 - COM14
7	COM1 - COM7	15	COM1 - COM15

### Display Duty Set Command

Assuming the original oscillation cycle as T, the time allocated to 1-digit display is 64T. The actual display time may be specified as 0 to 60T in increments of 4T. Assuming the number of display digits as n and the parameter provided by the Display Duty Set command as DC, the resultant display duty cycle ratio is as follows:

$$\frac{4(DC)}{64n} = \frac{(DC)}{16n}$$

Command format

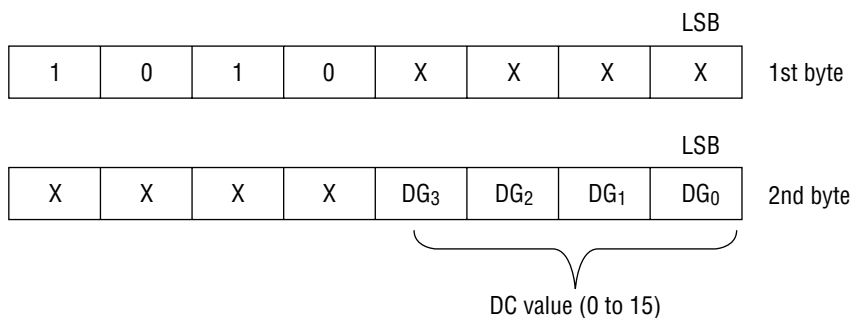

### Lamp Test Command

This command is used to set the All-Segment Display mode. If this occurs, the 36 segments for each digit to be displayed are put into the ON state. The number of display digits and the display duty cycle depend on the contents of the digit count register and of the duty register.

The contents of the internal RAM are not affected by this command. When the command is released, the original display appears once again.

Command format

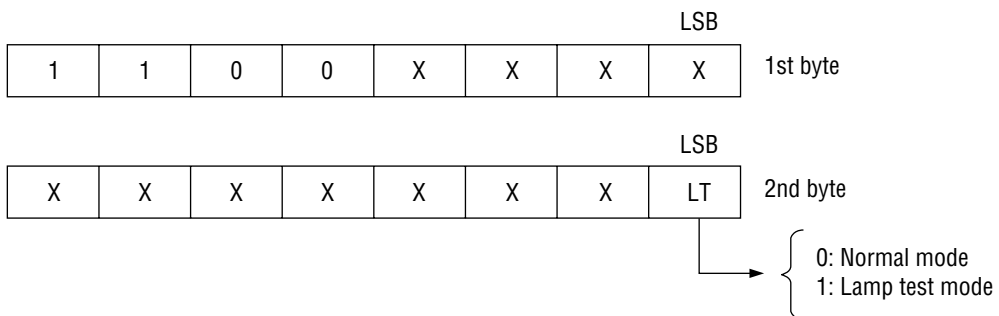



### Power On Reset Operation

Operations when the  $\overline{\text{RESET}}$  pin is Low are as follows:

- a. All segment driver outputs are Low.
- b. All grid driver outputs are Low.
- c. The number of display digits is set to 16.
- d. The display duty cycle is set to 0.

### Test Step and Test Count

These pins are used for inspection before shipment, and should not be used by the user. When this IC is mounted, leave them open or connect to  $V_{SS}$ . If they are connected to other pins, a malfunction may be caused.

**Relation Between Segment Output and VF Tube Dots**

1-1 SEG1	2-1 SEG2	3-1 SEG3	4-1 SEG4	5-1 SEG5
1-2 SEG6	2-2 SEG7	3-2 SEG8	4-2 SEG9	5-2 SEG10
1-3 SEG11	2-3 SEG12	3-3 SEG13	4-3 SEG14	5-3 SEG15
1-4 SEG16	2-4 SEG17	3-4 SEG18	4-4 SEG19	5-4 SEG20
1-5 SEG21	2-5 SEG22	3-5 SEG23	4-5 SEG24	5-5 SEG25
1-6 SEG26	2-6 SEG27	3-6 SEG28	4-6 SEG29	5-6 SEG30
1-7 SEG31	2-7 SEG32	3-7 SEG33	4-7 SEG34	5-7 SEG35
Cursor SEG36				

**Data Setup Flow**

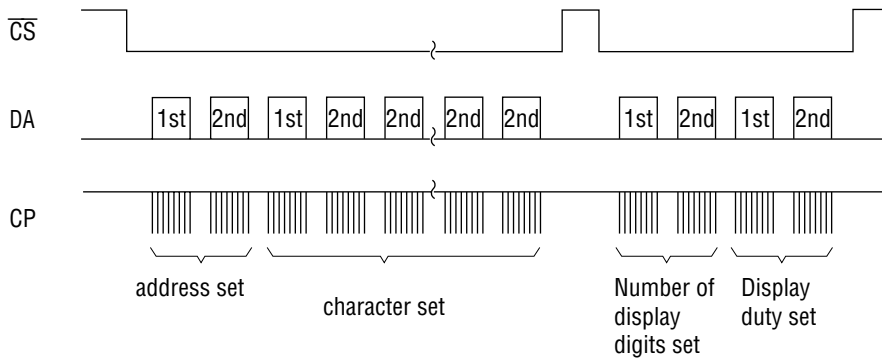
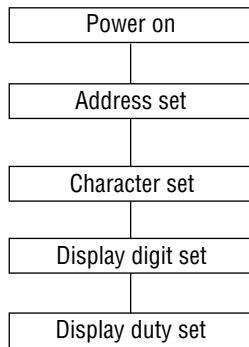

- 1st : the first byte
- 2nd : the second byte

Note: To avoid display malfunction due to external noise, re-set occasionally the number of display digits set and display duty set.





ADDRESS 55(37H)

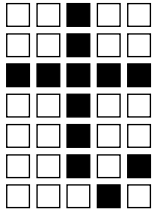

ADDRESS 56(38H)

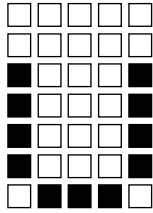

ADDRESS 57(39H)

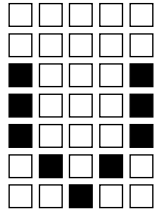

ADDRESS 58(3AH)

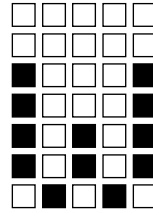

ADDRESS 59(3BH)

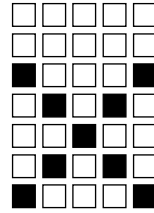

ADDRESS 60(3CH)

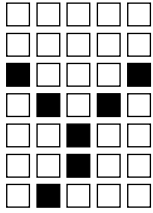

ADDRESS 61(3DH)

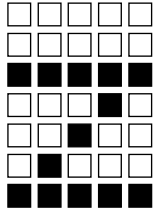

ADDRESS 62(3EH)

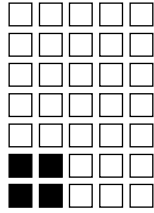

ADDRESS 63(3FH)

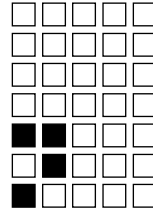

ADDRESS 64(40H)

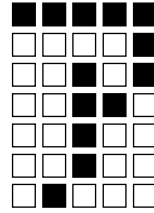

ADDRESS 65(41H)

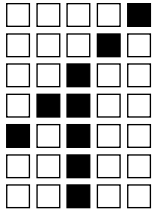

ADDRESS 66(42H)

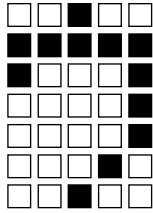

ADDRESS 67(43H)

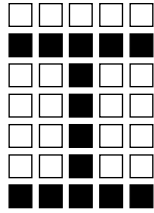

ADDRESS 68(44H)

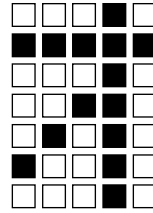

ADDRESS 69(45H)

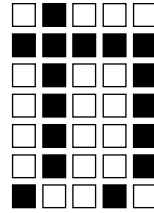

ADDRESS 70(46H)

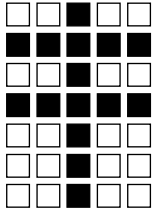

ADDRESS 71(47H)

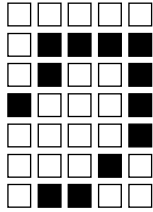

ADDRESS 72(48H)

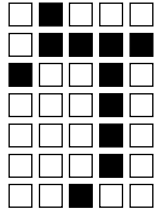

ADDRESS 73(49H)

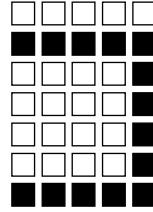

ADDRESS 74(4AH)

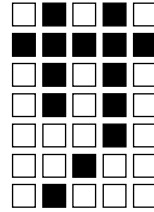

ADDRESS 75(4BH)

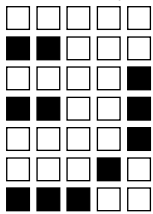

ADDRESS 76(4CH)

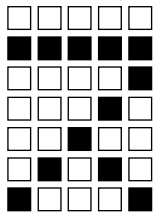

ADDRESS 77(4DH)

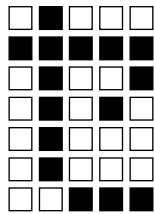

ADDRESS 78(4EH)

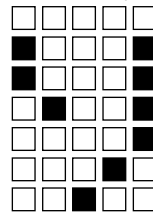

ADDRESS 79(4FH)

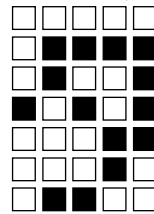

ADDRESS 80(50H)

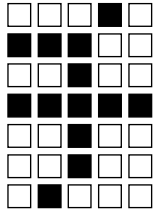

ADDRESS 81(51H)

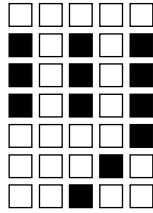

ADDRESS 82(52H)

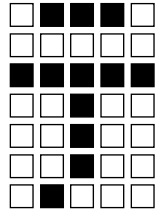

ADDRESS 83(53H)

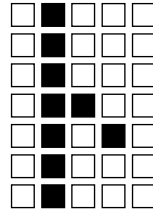

ADDRESS 84(54H)

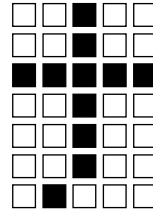

ADDRESS 85(55H)

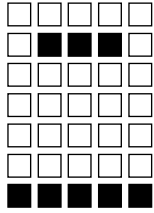

ADDRESS 86(56H)

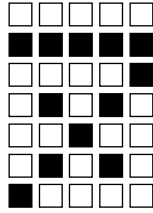

ADDRESS 87(57H)

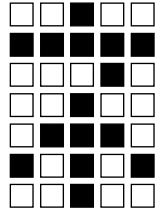

ADDRESS 88(58H)

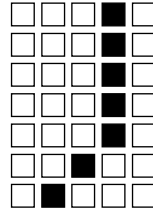

ADDRESS 89(59H)

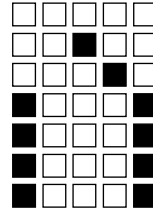

ADDRESS 90(5AH)

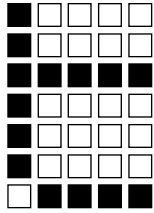

ADDRESS 91(5BH)

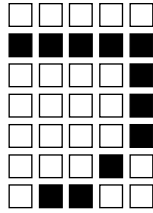

ADDRESS 92(5CH)

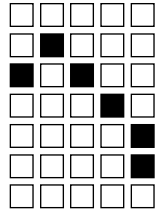

ADDRESS 93(5DH)

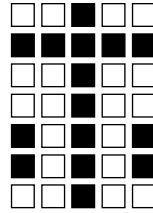

ADDRESS 94(5EH)

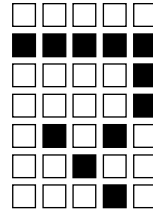

ADDRESS 95(5FH)

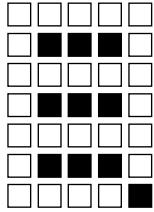

ADDRESS 96(60H)

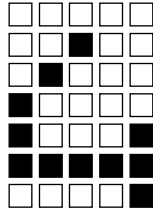

ADDRESS 97(61H)

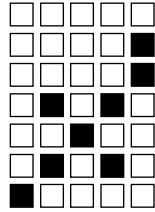

ADDRESS 98(62H)

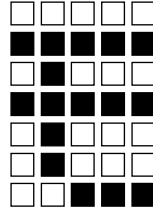

ADDRESS 99(63H)

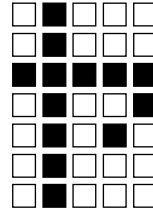

ADDRESS 100(64H)

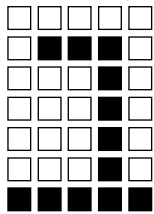

ADDRESS 101(65H)

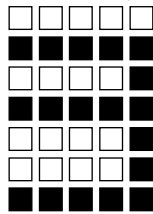

ADDRESS 102(66H)

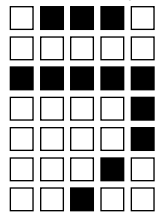

ADDRESS 103(67H)

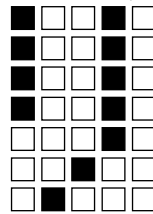

ADDRESS 104(68H)

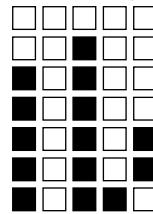

ADDRESS 105(69H)

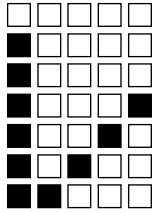

ADDRESS 106(6AH)

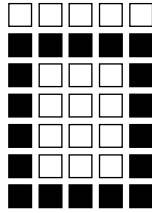

ADDRESS 107(6BH)

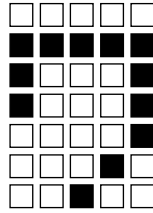

ADDRESS 108(6CH)

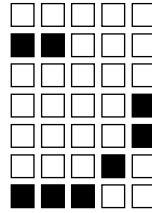

ADDRESS 109(6DH)

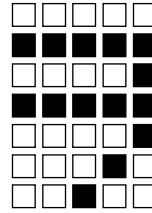

ADDRESS 110(6EH)

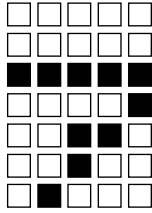

ADDRESS 111(6FH)

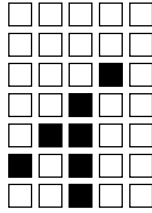

ADDRESS 112(70H)

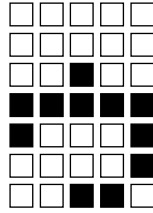

ADDRESS 113(71H)

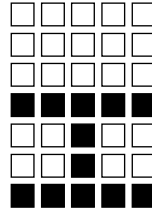

ADDRESS 114(72H)

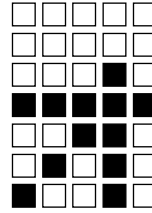

ADDRESS 115(73H)

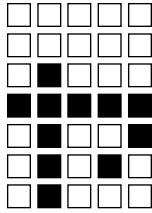

ADDRESS 116(74H)

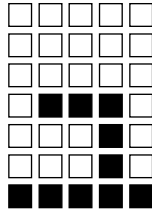

ADDRESS 117(75H)

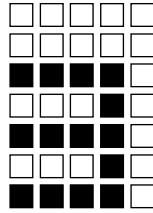

ADDRESS 118(76H)

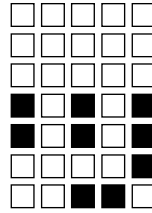

ADDRESS 119(77H)

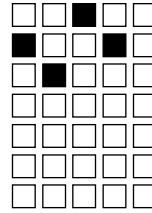

ADDRESS 120(78H)

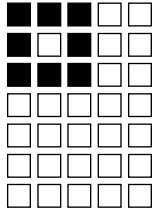

ADDRESS 121(79H)

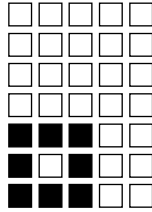

ADDRESS 122(7AH)

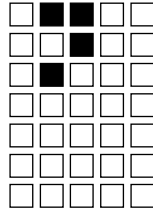

ADDRESS 123(7BH)

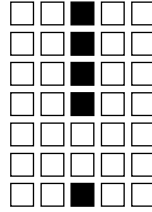

ADDRESS 124(7CH)

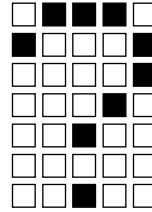

ADDRESS 125(7DH)

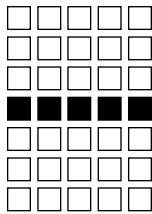

ADDRESS 126(7EH)

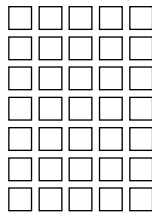

ADDRESS 127(7FH)

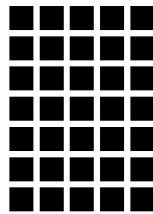



APPLICATION CIRCUIT

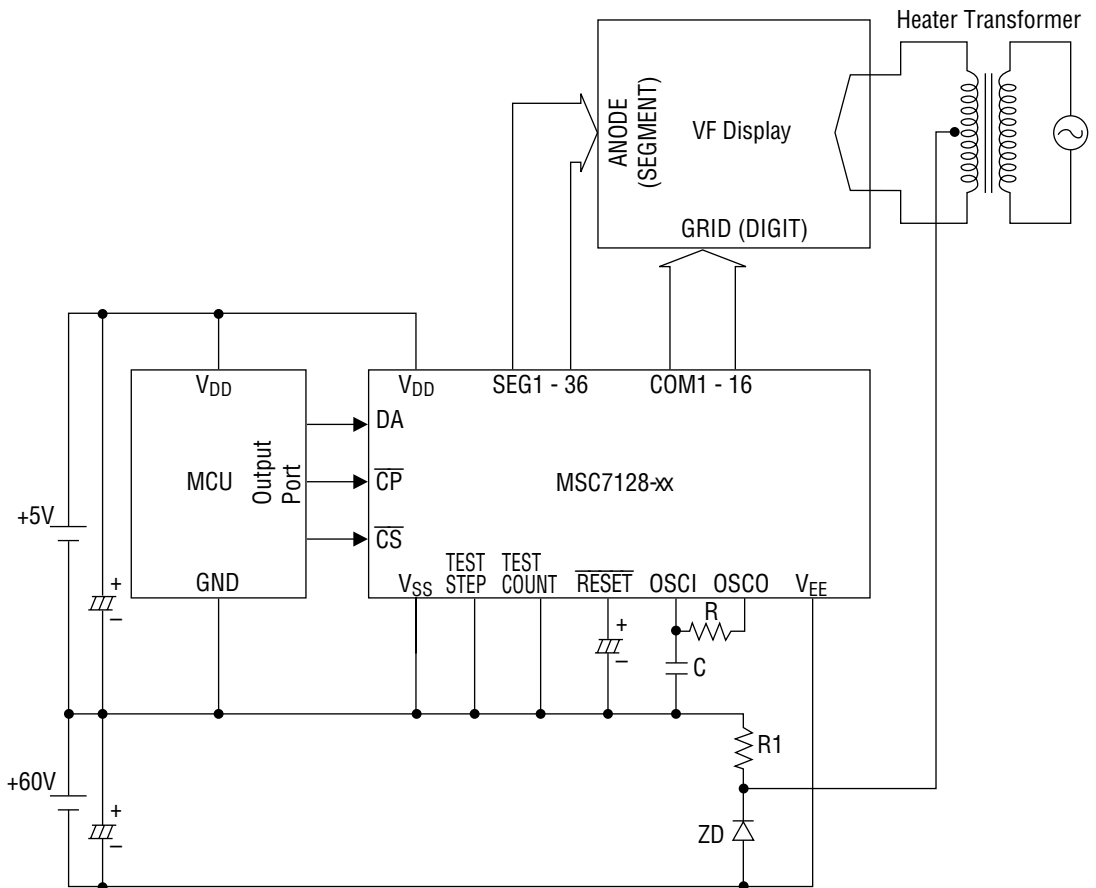

**PACKAGE DIMENSIONS**

(Unit : mm)

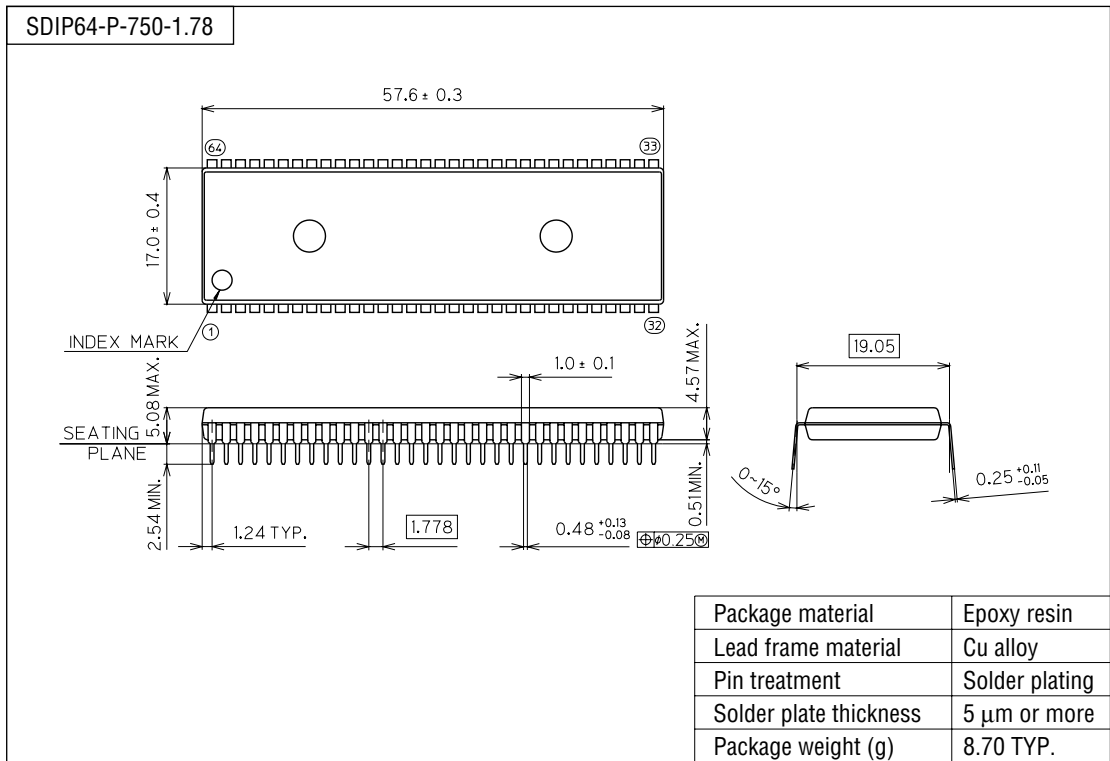

**Notes for Mounting the Surface Mount Type Package**

The SOP, QFP, TSOP, SOJ, QFJ (PLCC), SHP and BGA are surface mount type packages, which are very susceptible to heat in reflow mounting and humidity absorbed in storage. Therefore, before you perform reflow mounting, contact Oki's responsible sales person for the product name, package name, pin number, package code and desired mounting conditions (reflow method, temperature and times).

(Unit : mm)

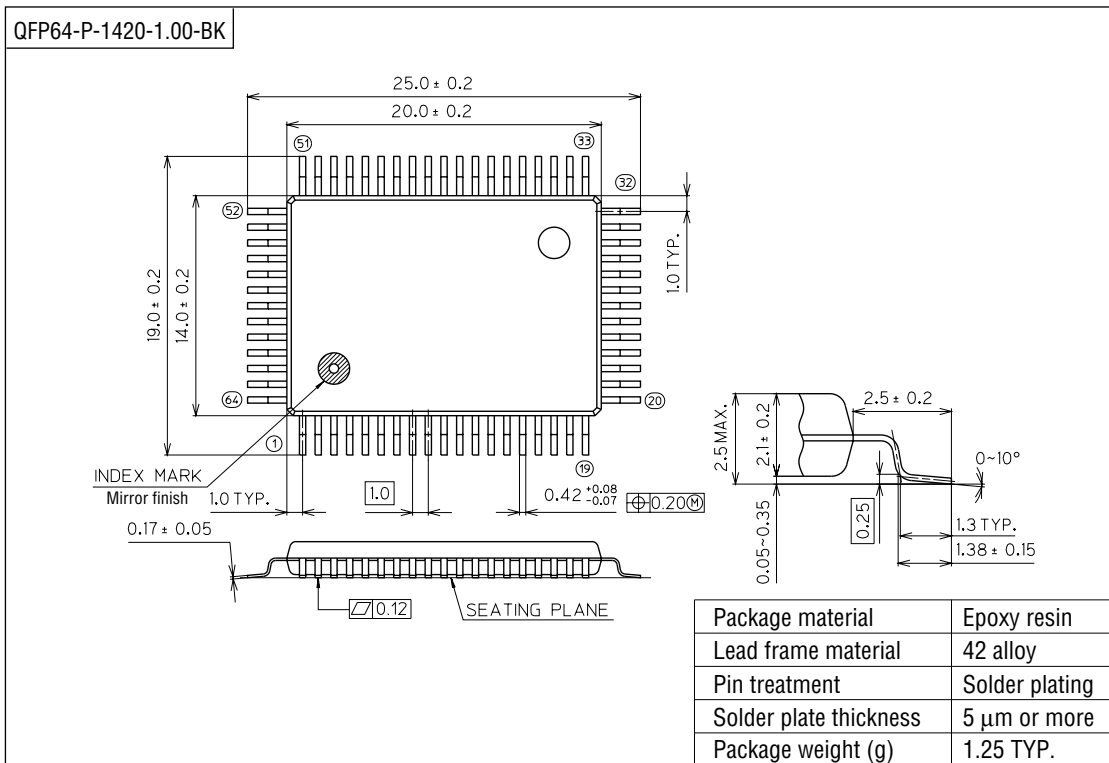

### Notes for Mounting the Surface Mount Type Package

The SOP, QFP, TSOP, SOJ, QFJ (PLCC), SHP and BGA are surface mount type packages, which are very susceptible to heat in reflow mounting and humidity absorbed in storage. Therefore, before you perform reflow mounting, contact Oki's responsible sales person for the product name, package name, pin number, package code and desired mounting conditions (reflow method, temperature and times).