

Si photodiode S6337-01

Large area photodiode for UV to IR, precision photometry

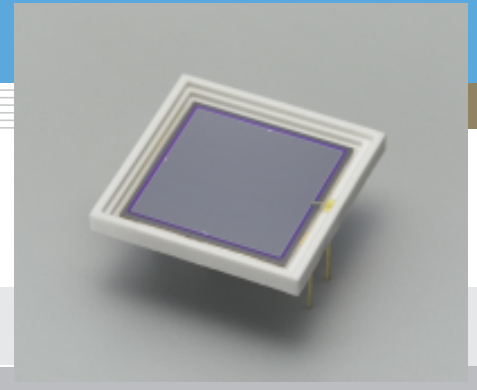

S6337-01 is a large area Si photodiode that features excellent spatial response uniformity over a wide range from UV to IR. S6337-01 will prove useful for precision photometry and as a standard detector for spectral response calibration.

Features

- Large active area: 18 × 18 mm
- Excellent uniformity even at wavelengths longer than 1000 nm
- High UV sensitivity
- Windowless package

Applications

- Precision photometry
- Spectral response calibration
- Analytical equipment
- Trap detector

■ Absolute maximum ratings (Ta=25 °C)

Parameter	Symbol	Value	Unit
Reverse voltage	VR Max.	5	V
Operating temperature	Topr	0 to +60	°C
Storage temperature	Tstg	0 to +80	°C

■ Electrical and optical characteristics (Ta=25 °C)

Parameter	Symbol	Condition	Min.	Typ.	Max.	Unit
Spectral response range	λ		-	190 to 1100	-	nm
Peak sensitivity wavelength	λ_p		-	960	-	nm
Photo sensitivity	S	$\lambda = \lambda_p$	-	530	-	mA/W
Short circuit current	Isc	100 lx, 2856 K	200	250	-	μ A
Dark current	ID	VR=10 mV	-	50	1000	pA
Rise time	tr	VR=0 V, RL=1 k Ω , λ =660 nm	-	7	-	μ s
Terminal capacitance	Ct	VR=0 V, f=10 kHz	-	3.5	-	nF
Shunt resistance	Rsh	VR=10 mV	10	200	-	M Ω
Uniformity *	U	Within 80 % of active area λ =190 to 1100 nm	-	-	0.5	%

■ Sensitivity uniformity (typical example, λ =1100 nm)

S6337-01 (18 × 18 mm)

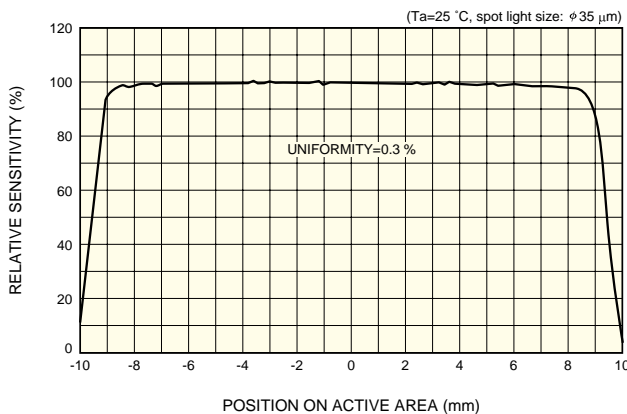

KSPDB0177EA

S1337-1010BQ (10 × 10 mm)

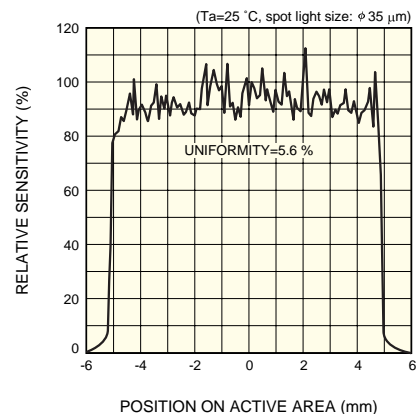

KSPDB0178EA

* Uniformity = R_s/R_m

Rs: Photo sensitivity at any point within 80 % of the active area

Rm: Averaged photo sensitivity within 80 % of the active area

■ Spectral response

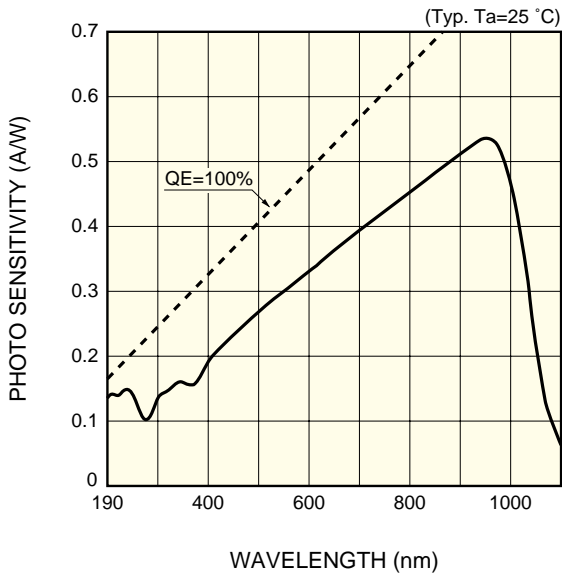

KSPDB0167EA

■ Dark current vs. reverse voltage

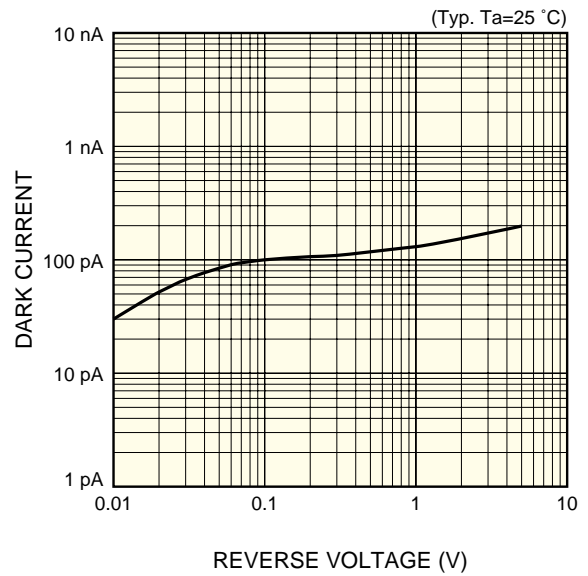

KSPDB0166EA

■ Terminal capacitance vs. reverse voltage

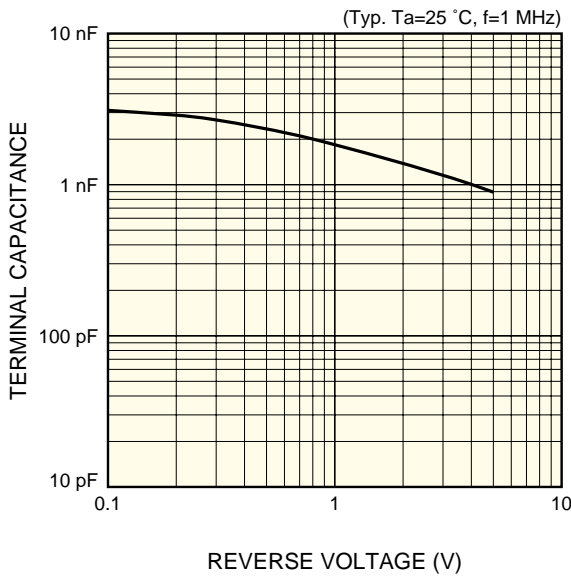

KSPDB0165EA

■ Dimensional outline (unit: mm)

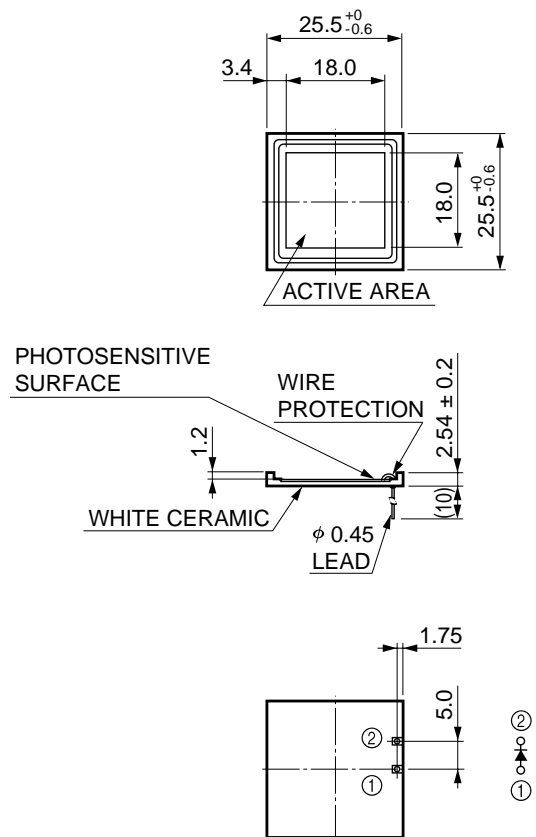

KSPDA0129EA